

FOREWORD

Dear Customer,

Thank you for selecting your new Kia vehicle.

As a global car manufacturer focused on building high-quality vehicles with exceptional value, Kia is dedicated to providing you with a customer service experience that exceeds your expectations.

An authorised Kia dealership where factory-trained technicians, recommended special tools, and genuine Kia replacement parts are provided can help if you need technical assistance.

This Owner's Manual will acquaint you with the operation of features and equipment that are either standard or optional on this vehicle, along with the maintenance needs of this vehicle. Therefore, you may find some descriptions and illustrations not applicable to your vehicle. You are advised to read this publication carefully and follow the instructions and recommendations. Please always keep this manual in the vehicle for your, and any subsequent owner's, reference.

All information contained in this Owner's Manual was accurate at the time of publication. However, as Kia continues to make improvements to its products, the company reserves the right to make changes to this manual or any of its vehicles at any time without notice and without incurring any obligations.

Please drive safely, and enjoy your Kia vehicle!

© 2022 Kia Corporation

All rights reserved. May not be reproduced or translated in whole or in part without the written consent of Kia Corporation.

Printed in Korea

How to use this manual

We want to help you get the greatest possible driving pleasure from your vehicle. Your Owner's Manual can assist you in many ways.

We strongly recommend that you read the entire manual. In order to minimise the chance of death or injury, you must read the WARNING and CAUTION sections in the manual.

Illustrations complement the words in this manual to best explain how to enjoy your vehicle. By reading your manual, you learn about features, important safety information, and driving tips under various road conditions.

The general layout of the manual is provided in the Table of Contents. Use the index when looking for a specific area or subject, it has an alphabetical listing of all information in your manual.

Chapters: This manual has nine chapters plus an index. Each chapter begins with a brief list of contents so you can tell at a glance if that chapter has the information you want.

You will find various WARNINGS, CAUTIONS, and NOTICES in this manual. These WARNINGS were prepared to enhance your personal safety. You should carefully read and follow ALL procedures and recommendations provided in these WARNINGS, CAUTIONS and NOTICES.

WARNING

A WARNING indicates a situation in which harm, serious bodily injury or death could result if the warning is ignored.

CAUTION

A CAUTION indicates a situation in which damage to your vehicle could result if the caution is ignored.

NOTICE

A NOTICE indicates interesting or helpful information is being provided.

Table of Contents

Hybrid system overview	1
Introduction	2
Your vehicle at a glance	3
Safety features of your vehicle	4
Features of your vehicle	5
Driving your vehicle	6
What to do in an emergency	7
Maintenance	8
Specifications & Consumer information	9
Abbreviation	A
Index	I

PHEV (Plug-in Hybrid Electric Vehicle) system	1-2
HEV (Hybrid Electric Vehicle) system.....	1-3
Charging the plug-in hybrid vehicle	1-4
• Charging information	1-4
• Charging time	1-4
• Charging types	1-5
• Charging status	1-6
• AC charging connector lock.....	1-8
• Scheduled charging	1-9
• Charging precautions	1-10
• AC charger	1-12
• Trickle charger (portable charging cable).....	1-14
• How to disconnect charging connector in emergency... 1-28	
Driving the hybrid/plug-in hybrid vehicle	1-29
• Starting the vehicle.....	1-29
• Changing plug-in hybrid mode (Plug-in hybrid vehicle). 1-30	
• Special features	1-31
• Hybrid system gauge	1-32
• Warning and indicator lights.....	1-34
• LCD display messages	1-35
• Energy flow	1-42
Components of the hybrid/plug-in hybrid vehicle	1-47
• Plug-in hybrid vehicle components.....	1-47
• Hybrid vehicle components.....	1-51
• Service interlock connector	1-55
• If an accident occurs	1-55
• When the hybrid vehicle shuts off	1-56

Hybrid system overview

PHEV (Plug-in Hybrid Electric Vehicle) system

The Kia Plug-in Hybrid Electric Vehicle (PHEV) shares the characteristics of both a conventional hybrid electric vehicle and an all-electric vehicle.

When used as a conventional hybrid electric vehicle, the HEV computer selectively operates between the engine and the electric motor or even both at the same time.

When it is operating in the electric vehicle mode, the vehicle is driven only using the electric motor over a certain distance until the hybrid battery becomes low. The driving distance in EV mode depends on

customer driving style and road conditions. Aggressive driving manoeuvres may at times temporarily enable the engine to operate.

The engine power could be limited during emission reduction control period at cold engine condition.

The hybrid battery can be fully charged by connecting a plug to an external electric power source.

An engine can be turned on due to factors such as heater and a frequent operation of the accelerator pedal by a driver in CD mode.

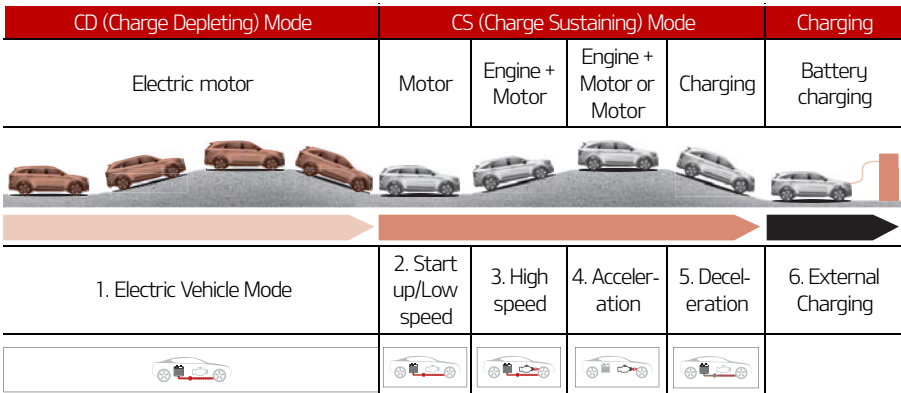

HEV (Hybrid Electric Vehicle) system

The Kia Hybrid Electric Vehicle (HEV) uses both the petrol engine and the electric motor for power. The electric motor is run by a high-voltage HEV battery.

Depending on the driving conditions, the HEV computer selectively operates between the engine and the electric motor or even both at the same time.

Fuel efficiency increases when the vehicle is driven by the electric motor with the HEV battery.

The HEV battery charge must be maintained, so at times the engine will come on even at idle to act as a generator. Charging also occurs when decelerating or by regenerative braking.

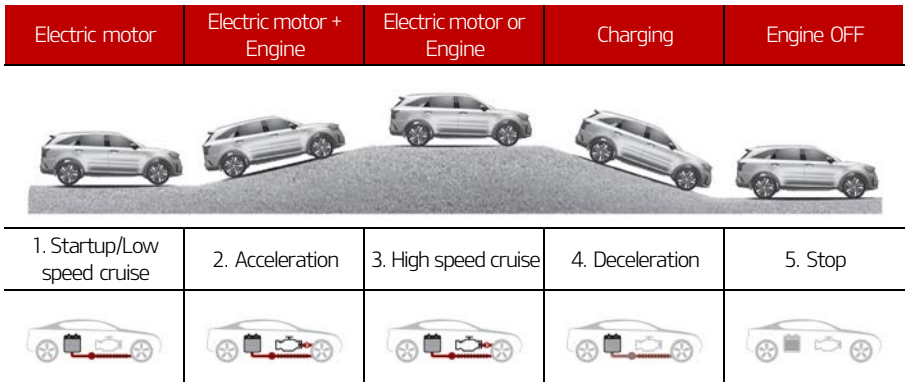

Charging the plug-in hybrid vehicle







Charging information

- AC Charger: The plug-in hybrid vehicle is charged by plugging into a AC charger installed in your home or a public charging station. (For further details, refer to "AC charger" on page 1-12.)
- Trickle Charger: The plug-in hybrid vehicle can be charged by using household electricity. The electrical outlet in your home must comply with regulations and can safely accommodate the Voltage/Current (Amps)/Power (Watts) ratings specified on the trickle charge. Use only as a backup charger.

Charging time

- AC Charger: Takes about 3 hours 25 minutes at room temperature (Can be charged to 100%). Depending on the condition and durability of the high-voltage battery, charger specifications, and ambient temperature, the time required for charging the high-voltage battery may vary.
- Trickle Charger: For charging at home. Please note that the Trickle Charger is slower than the AC Charger.

Charging types

Category	Charging Inlet (Vehicle)	Charging Connector	Charging Outlet	Charging Method	Charging Time
AC Charger		 OMQ4PHQ011070L	 OBDCPQ019003RE	AC charger installed in homes or public charging stations	Approximately 3 hours 25 minutes (to fully charge, 100%)
Trickle Charger	 OMQ4PHQ011038L	Type A	Type A	Household current	For charging at home. Please note that the Trickle Charger is slower than the AC Charger
		 OMQ4PHQ011070L	 OAEEQ016024		
		Type B	Type B		
		 OMQ4PHQ011071L	 OCDPQ011063L		

- Depending on the condition and durability of the high voltage battery, charger specifications, and ambient temperature, the time required for charging the high voltage battery may vary.
- Actual charger image and charging method may vary in accordance with the charger manufacturer.

Charging status

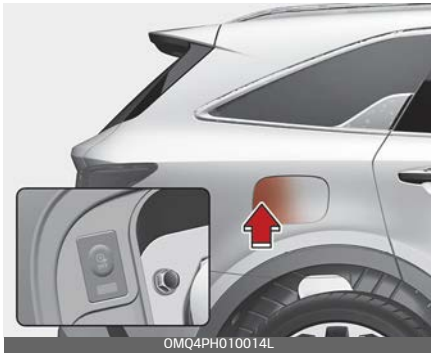

You can check the charging status at the outside of vehicle when charging or using (it is not driving status) the high-voltage battery.

It takes about 3 ~ 4 hours or more to complete charging.

Classification		Details		Operation of charging indicator lamp	
Mode	Status			Charging inlet	Charging button
A	READY	Non-charging state	0 ~ 65 %	On (Yellow)	Off
			65 ~ 100 %	On (Green)	Off
B	Aux. Battery Saver/ High voltage warning	Charging the 12V auxiliary battery / High voltage warning state		On (Red)	Off
C	Charging	Charging	0 ~ 65 %	Blinking (Yellow)	Off
			65 ~ 100 %	Blinking (Green)	Off
D	Charging complete	Charging completed (turns off in 5 seconds)	100 %	On (Green) > OFF	Off
E	Charging failed	Error whilst charging		Blinking (Red)	Off
F	Scheduled charging standby	Reserved charging is operating (turns OFF after 3 minutes)		Off	On
G	Error	CAN communication error status		On (Green) > On (Orange) > On (Red) (Repeat)	Off

Checking charging status

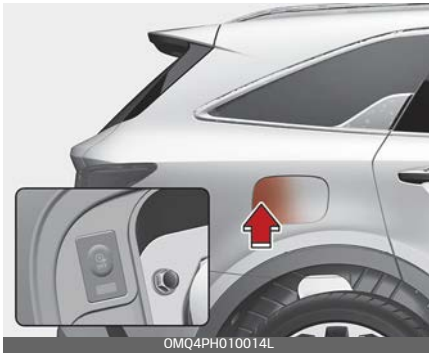

You can check the charging status at the outside of vehicle when charging or using (it is not driving status) the high-voltage battery.

It takes about 3 ~ 4 hours or more to complete charging.

For more information about charging status indicator, refer to "Charging status" on page 1-6.

How to disconnect AC charger

1. The vehicle doors must be unlocked in order to be able to disconnect the charging connector. A lock system prevents charging cable disconnection when the vehicle's doors are locked.

* NOTICE

In order to disconnect the charging connector, unlock the doors to unlatch the charging connector lock system. If not, the charging connec-

tor and the vehicle's charging inlet may be damaged.

2. Hold the charging connector handle and pull it out.



To prevent charging cable theft, the charging connector cannot be disconnected from the inlet when the doors are locked.

However, if the vehicle is in the charging connector AUTO mode, the charging connector automatically unlocks from the inlet when charging is completed.

If the connector is not automatically unlocked after charging is completed in AUTO mode, the connector is unlocked when all of the doors are unlocked.

For more details, refer to "AC charging connector lock" on page 1-8.

* NOTICE

When disconnecting the charging connector, do not try to disconnect it by force whilst not pressing the release button. This may damage

the charging connector and vehicle charging inlet.

3. Close the charging door by pressing the rear centre edge of the charging door.



* The charging door does not have a locking system.

*** NOTICE**

- If you cannot open the charging door due to freezing weather, tap lightly or remove any ice near the charging door. Do not try to forcibly open the charging door. If you open it by force, the charging door may be damaged.
- Do not modify or disassemble the charging cable components. It may cause a fire or an electric shock with personal injury.
- Keep the charging connector and the charging plug clean and dry. The charging cable should be also kept dry.

- Use an air gun to blow any foreign substances from the charging connector and the charging plug.

AC charging connector lock

This AC charging connector lock function prevents an outsider from removing the charging connector from the charging inlet.

Connector lock

	Always lock	Lock whilst charging
Before charging	0	X
Whilst charging	0	0
After charging	0	X

Always lock

The connector locks when the charging connector is plugged into the charging inlet. The connector is locked until all doors are unlocked by the driver. This mode can be used to prevent charging cable theft.

- If the charging connector is unlocked when all doors are unlocked, but the charging cable is not disconnected within 15 seconds, the connector will be automatically locked again.
- If the charging connector is unlocked when all doors are unlocked, but all doors are locked again, immediately, the connec-



tor will be automatically locked again.

Lock whilst charging

The connector locks when charging starts. The connector unlocks when charging is complete.

Scheduled charging

- You can set reserved charging using the infotainment system. Refer to the infotainment system for detailed information about setting reserved charging.
- Scheduled charging can only be done when using a AC charger or the portable charging cable (ICCB: In-Cable Control Box).
- When scheduled charging is set and the AC charger or the portable charging cable (ICCB: In-Cable Control Box) is connected for charging, the indicator lamp blinks (for 3 minutes) to indicate that scheduled charging is set.

- When scheduled charging is set, charging is not initiated immediately when the AC charger or portable charging cable (ICCB: In-Cable Control Box) is connected.
- If charging is required immediately, turn off the scheduled charge using the infotainment system and UVO application, or Press the vehicle's scheduled charge release button more than 2 seconds ().
- When the scheduled charge is set, the charge start time is calculated by itself. In some cases, charging may start immediately after connecting the charger.
- If you press the scheduled charging deactivation () button to immediately charge the battery, charging must be initiated 3 minutes after the charging cable has been connected.

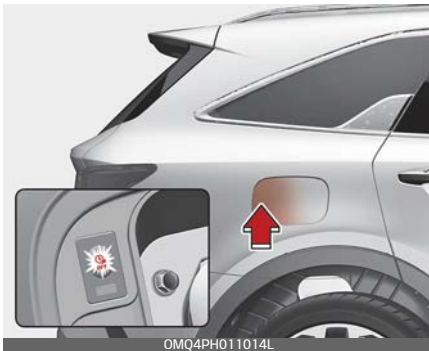

When you press the scheduled charging deactivation () button for immediate charging, the scheduled charge setting is not completely deactivated. If you need to completely deactivate the scheduled charge setting, use the infotainment system to finalise the deactivation. Refer to "AC charger" on page 1-12 or "Trickle charger (portable charging cable)" on page 1-14 for details about connecting the AC charger and the portable charger (ICCB: In-Cable Control Box).

Charging precautions

AC Charger



⚠ WARNING

Fires caused by dust or water

Do not connect the charging cable connector plug to the vehicle if there is water or dust on the charging inlet. Connecting whilst there is water or dust on the charging cable

connector and plug may cause a fire or electric shock. There may be a risk of fire and injury when using old worn out public electrical outlets.

⚠ WARNING

Interference with electronic medical devices

When using medical electric devices such as an implantable cardiac pacemaker, make sure to ask the medical team and manufacturer whether charging your electric vehicle will impact the operation of the medical devices. In some instances, electromagnetic waves that are generated from the charger can seriously impact medical electric devices such as an implantable cardiac pacemaker.

⚠ WARNING

Touching the charging connector

Do not touch the charging connector, charging plug, and the charging inlet when connecting the cable to the charger and the charging inlet on the vehicle. Doing so may result in electrocution.

- Comply with the following in order to prevent electrical shock when charging:
 - Use a waterproof charger
 - Make sure to not touch the charging connector and charging plug when your hand is wet
 - Do not charge when there is lightning
 - Do not charge when the charging connector and plug is wet

⚠ WARNING

Charging cable

- Immediately stop charging when you find abnormal symptoms (smell, smoke).
- Replace the charging cable if the cable coating is damaged to prevent electrical shock.
- When connecting or removing the charging cable, make sure to hold the charging connector handle and charging plug.
If you pull the cable itself (without using the handle), the internal wires may disconnect or get damaged. This may lead to electric shock or fire.

⚠ WARNING

Cooling fan

Do not touch the cooling fan whilst vehicle is charging. When the vehicle is switched OFF whilst charging, the cooling fan inside the motor compartment may automatically operate.

- Always keep the charging connector and charging plug in clean and dry condition. Be sure to keep the charging cable in a condition where there is no water or moisture.
- Make sure to use the designated charger for charging the vehicle. Using any other charger may cause failure.
- Before charging the battery, turn the vehicle OFF.
- Be careful not to drop the charging connector. The charging connector can be damaged.

AC charger

AC Charger



AC charger cable (Type A)



AC charger cable (Type B)



You can charge your vehicle by plugging into a public charger at a charging station.

How to connect AC charger

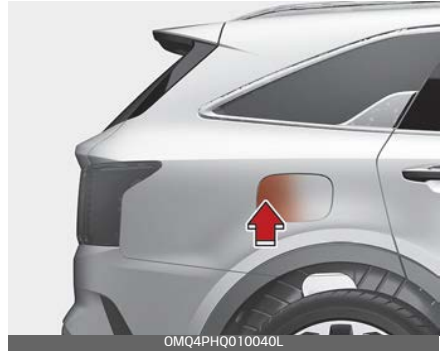

1. Depress the brake pedal and apply the parking brake.
2. Turn OFF all switches, move the shift dial to P (Park), and turn OFF the vehicle.
3. Open the charging inlet door by pressing rear centre edge of the charging inlet door.
4. Remove any dust on the charging connector and charging inlet.
5. Hold the charging connector handle.



Then, insert the charger into the charging inlet, until you hear a click sound. If it is not fully connected, a bad connection between the charging connector and the charging terminals may cause a fire.

6. Check if the charging cable connection indicator of the high voltage battery in the instrument cluster is turned ON.



Charging does not occur when the indicator is OFF. When the charging connector is not connected properly, reconnect the charging cable to charge.

* NOTICE

- The charging is in progress only with the shift dial is in P (Park). Charging the battery with the ENGINE START/STOP button in the ACC position is possible. However, it may discharge the 12-V

battery. Thus, if possible, charge the battery with the ENGINE START/STOP button in the OFF position.

- Moving the shift dial from P (Park) to R (Reverse)/N (Neutral)/D (Drive) stops the charging process. To restart the charging process, move the shift dial to P (Park), press the ENGINE START/STOP button to the OFF position, and disconnect the charging cable. Then, connect the charging cable.

Charging connector lock mode

When the charging connector is plugged into the charging inlet, the connector lock timing varies with the modes selected by the user settings menu or the infotainment screen menu.

- Always lock: The connector locks when the charging connector is plugged into the charging inlet.
- Lock whilst charging: The connector locks when charging starts. The connector unlocks when charging is completed.

For more details, refer to "AC charging connector lock" on page 1-8.

Trickle charger (portable charging cable)

Type A

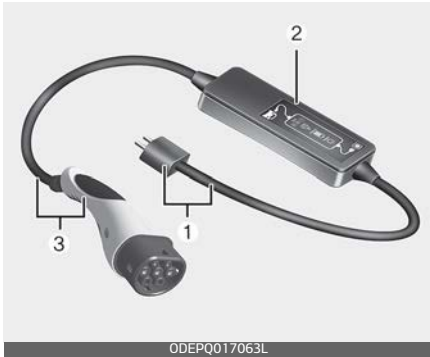

Type B



Trickle charger can be used if AC Charger is unavailable.

1. Plug and cable
2. Control box (ICCB)
3. Charging connector/cable

How to connect portable charging cable (ICCB: In-Cable Control Box) (Type A)

1. Turn OFF all switches, move the shift dial to P (Park), and turn OFF the vehicle.
2. Connect the plug to a household electric outlet.

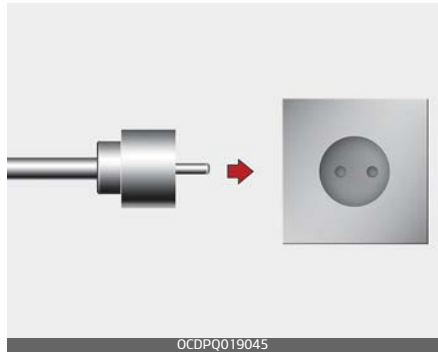

3. Make sure that the power connection indicator (green) lights in the control box.



4. Depress the brake pedal and apply the parking brake.

- Open the charging inlet door by pressing rear centre edge of the charging inlet door.



- Remove any dust on the charging connector and charging inlet.
- Hold the charging connector handle.



Vehicle connection



Then, insert it into the charging inlet, until you hear a click sound. If it is not fully connected, improper connection between the charging connector and the charging terminals are a potential fire hazard.

- Charging starts automatically and the charging light blinks.



- Check if the charging cable connection indicator of the high voltage battery in the instrument cluster is turned ON.



Charging does not occur when the indicator is OFF. When the charging connector is not connected properly, reconnect the charging cable to charge.

*** NOTICE**

- The charging is in progress only with the shift dial is in P (Park). Charging the battery with the ENGINE START/STOP button in the ACC position is possible. However, it may discharge the 12-V battery. Thus, if possible, charge the battery with the ENGINE START/STOP button in the OFF position.
- Moving the shift dial from P (Park) to R (Reverse)/N (Neutral)/D (Drive) stops the charging process. To restart the charging process, move the shift dial to P (Park), press the ENGINE START/STOP button to the OFF position, and disconnect the charging cable. Then, connect the charging cable and restart the charging process.

10. After charging has started, the estimated charging time is displayed on the instrument cluster for about 1 minute. It is also displayed, when the driver's door is opened with charging in progress. When scheduled charging is set, the estimated charging time is displayed as "--".



0MQ4PHQ010048L

How to connect portable charging cable (ICCB: In-Cable Control Box) (Type B)

1. Turn OFF all switches, move the shift dial to P (Park), and turn OFF the vehicle.
2. Connect the plug to a household electric outlet.

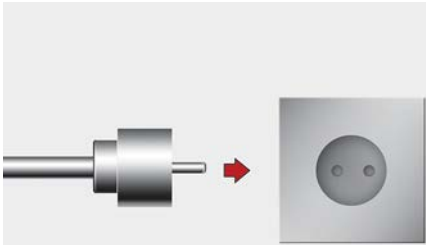

OCDPQ019045

3. Check if the power lamp (green) illuminates on the control box.



OCDP0011066L

4. Depress the brake pedal and apply the parking brake.
5. Open the charging inlet door by pressing rear center edge of the charging inlet door.



OMQ4PHQ010040L

6. Remove any dust on the charging connector and charging inlet.
7. Hold the charging connector handle.



OMQ4PHQ011073L



OCDPQ011067L

Then, insert it into the charging inlet, until you hear a click sound.

If it is not fully connected, improper connection between the charging connector and the charging terminals are a potential fire hazard.

8. Charging starts automatically (charging lamp illuminates).



9. Check if the charging cable connection indicator of the high voltage battery in the instrument cluster is turned ON.



Charging does not occur when the indicator is OFF. When the charging connector is not connected properly, reconnect the charging cable to charge.

*** NOTICE**

- The charging is in progress only with the shift dial is in P (Park). Charging the battery with the ENGINE START/STOP button in the ACC position is possible. However, it may discharge the 12-V battery. Thus, if possible, charge the battery with the ENGINE START/STOP button in the OFF position.
- Moving the shift dial from P (Park) to R (Reverse)/N (Neutral)/D (Drive) stops the charging process. To restart the charging process, move the shift dial to P (Park), press the ENGINE START/STOP button to the OFF position, and disconnect the charging cable. Then, connect the charging cable and restart the charging process.

10. After charging has started, the estimated charging time is displayed on the instrument cluster for about 1 minute. It is also displayed, when the driver's door is opened with charging in progress. When scheduled charging is set, the estimated charging time is displayed as "--".



OMQ4PHQ010048L



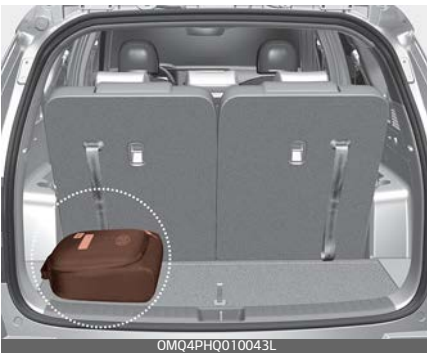









Charging cable storage











OMQ4PHQ010043L

We recommend that the trickle charger cable should be put in the storage box after use.

Charging status indicator lamp for portable charging cable (Type A)

Control Box	Indicator		Details
	PLUG	 (Green)	On: Power on Blink: Plug temperature sensor failure
		 (Red)	On: Plug high temperature protection Blink: Plug high temperature warning
	POWER	 POWER	On: Power on
	CHARGE	 CHARGE	Blink: Charging In power saving mode, only the CHARGE indicator is illuminated.
	FAULT	 FAULT	Blink: Charging interrupted
	CHARGE LEVEL		Charging current 12A
			Charging current 10A
			Charging current 8A
	VEHICLE	 (Green)	Charging connector plugged
		 (Blue)	Charging
		 (Red)	Blink: Charging impossible

NO	Control Box	Status/Diagnosis/Countermeasure	NO	Control Box	Status/Diagnosis/Countermeasure
1		<ul style="list-style-type: none"> Charging connector plugged into vehicle (Green ON) Plug temperature sensor failure (Green blink) Plug high temperature protection (Red blink) Plug high temperature warning (Red ON) <p>Have the system inspected by a professional workshop. Kia recommends to visit an authorised Kia dealer/service partner.</p>	2		<ul style="list-style-type: none"> Charging connector plugged into vehicle (Green ON)
3		<ul style="list-style-type: none"> Whilst charging <ul style="list-style-type: none"> Charge indicator (Green blink) Vehicle indicator (Blue ON) 	4		<ul style="list-style-type: none"> Before plugging charging connector into vehicle (Red blink) <ul style="list-style-type: none"> Abnormal temperature ICCB (In-Cable Control Box) failure <p>Have the system inspected by a professional workshop. Kia recommends to visit an authorised Kia dealer/service partner.</p>
5		<ul style="list-style-type: none"> Plugged into vehicle (Red blink) <ul style="list-style-type: none"> Diagnostic device failure Current leakage Abnormal temperature <p>Have the system inspected by a professional workshop. Kia recommends to visit an authorised Kia dealer/service partner.</p>	6		<ul style="list-style-type: none"> After plugging charging connector into vehicle (Red blink) <ul style="list-style-type: none"> Communication failure <p>Have the system inspected by a professional workshop. Kia recommends to visit an authorised Kia dealer/service partner.</p>
7		<ul style="list-style-type: none"> Plug temperature sensor failure (Green blink) Plug high temperature protection (Red blink) Plug high temperature warning (Red ON) <p>Have the system inspected by a professional workshop. Kia recommends to visit an authorised Kia dealer/service partner.</p>	8		<ul style="list-style-type: none"> Power saving mode <ul style="list-style-type: none"> 3 minutes after charging starts (Green blink)

Charging Status Indicator Lamp for Portable Charging Cable (Type B)



Indicator		Details
POWER		On: Power on
CHARGE		On: Charge Blink: Current limit due to high plug temperature or high internal temperature
FAULT		Blink: Charging interrupted
CHARGE LEVEL	12	12 A
	10	10 A
	08	8 A
	06	6 A
	<p>The charging current changes whenever the button (1) is pressed for less than 1 sec with the charger plugged into an electrical outlet but not the vehicle.</p>	

Indicator	Details		
Error code	On : Error while charging/ Error during self-diagnosis		
	Error code	Item	Cause
	E1	CP communication	Vehicle communication error
	E2	Leakage	Current leakage
	E3		Charger error
	E4	Plug temperature	Plug overtemperature warning
	E5		Plug temperature failure
	E6		Charger error
	E7	Overcurrent	Charging overcurrent warning
	E8	Internal temperature	Charger overheating
	E9		Charger error
	F1	Relay fusion	Charger error
	F2	GM/I	Poor grounding of outlet
	F3	SMPS Power failure	SMPS error (voltage failure)
	F4		SMPS error (abnormal voltage)
	F5	CP voltage error	CP (-) voltage error
	F6		CP (+) voltage error
	F7	Temperature sensor error	Plug temperature sensor error
	F8		PCB internal temperature sensor error

Status/Diagnosis/Countermeasure (Type B)



- Charging connector plugged into vehicle (POWER Green ON)
- Plug connected to an electric outlet (POWER Green ON)

While charging



- Charge indicator (POWER Green ON/CHARGE Blue ON)
- Charging current

Before plugging charging connector into vehicle (POWER Green ON, FAULT Red blink)



- Abnormal temperature
- CCB (In-Cable Control Box) failure

Plugged into vehicle (POWER Green ON, FAULT Red Blink)



- Diagnostic device failure
- Current leakage
- Abnormal temperature

Leakage current failure (POWER Green ON, FAULT Red Blink)



OCDPQ011070L

- After disconnecting and reconnecting the power plug, press and release the button for 2 seconds or longer to clear the error.

Power saving mode



OCDPQ011071L

- Charge level indicator is turned off if there is no status change for more than 1 minute.

How to disconnect portable charging cable (ICCB: In-Cable Control Box)

1. Before disconnecting the charging connector, make sure the doors are unlocked. When the door is locked, the charging connector lock system will not allow disconnection. To prevent charging cable theft, the charging connector cannot be disconnected from the inlet when the doors are locked. However, if the vehicle is in the charging connector AUTO mode, the charging connector automatically unlocks from the inlet when charging is completed.

* NOTICE

In order to disconnect the charging connector, unlock the doors to unlatch the charging connector lock system. If not, the charging connector and the vehicle's charging inlet may be damaged.

2. Hold the charging connector handle and pull it out.



3. Make sure to securely close the charging door.
 4. Disconnect the plug from the household electric outlet. Do not pull the cable when disconnecting the plug.

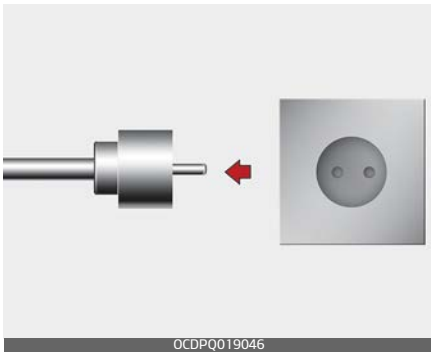

5. Close the protective cover for the charging connector so that foreign material cannot get into the terminal.
 6. Put the charging cable inside the cable compartment to protect it.

Precautions for portable charging cable (ICCB: In-Cable Control Box)

- Use the portable charging cable that is certified by Kia.
- Do not try to repair, disassemble, or adjust the portable charging cable.
- Do not use an extension cord or adapter.
- Stop using immediately if failure warning light occurs.
- Do not touch the plug and charging connector with wet hands.
- Do not touch the terminal part of the AC charging connector and the AC charging inlet on the vehicle.
- Do not connect the charging connector to voltage that does not comply with regulations.
- Do not use the portable charging cable if it is worn out, exposed, or there exists any type of damage on the portable charging cable.
- If the ICCB case and AC charging connector is damaged, cracked, or the wires are exposed in any way, do not use the portable charging cable.
- Do not let children operate or touch the portable charging cable.
- Keep the control box free of water.
- Keep the AC charging connector or plug terminal free of foreign substances.

- Do not step on the cable or cord. Do not pull the cable or cord and do not twist or bend it.
 - Do not charge when there is lightning.
 - Do not drop the control box or place a heavy object on the control box.
 - Do not place an object that can generate high temperatures near the charger when charging.
 - Charging with the worn out or damaged household electric outlet can result in a risk of electric shock. If you are in doubt to the household electric outlet condition, have it checked by a licensed electrician.
 - Stop using the portable charging cable immediately if the household electric outlet or any components is overheated or you notice burnt odours.
2. Check the operation status of the AC charger, portable charger. (Status of portable charger)
 - * Actual method for indicating the charging status may vary in accordance with the charger manufacturer.
 3. When the vehicle does not charge and a warning message appears on the instrument cluster, check the corresponding message.
 4. If the vehicle is properly charged when charged with another normally working charger, contact the charger manufacturer.
 5. If the vehicle does not charge when charged with another normally working charger, we recommend that you contact an authorised Kia dealer/service partner for inspection.

Actions to be taken for electric vehicle charging issues

When you cannot charge the high voltage battery after connecting the charger, check the following:

1. Check the charging settings for the vehicle.
(e.g. when scheduled charging is set, charging is not initiated immediately when the AC charger or portable charger is connected.)

How to disconnect charging connector in emergency

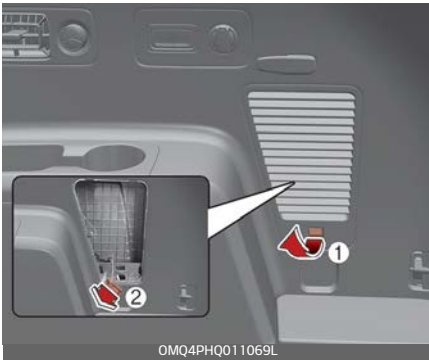

If the charging connector does not disconnect due to battery discharge and/or failure of the electric system, open the cover (1) on the right side of the luggage room and slightly pull the emergency cable (2). The charging connector will then disconnect.

Driving the hybrid/plug-in hybrid vehicle

Starting the vehicle

Vehicles with smart key system

1. Carry the smart key or leave it inside the vehicle.
2. Make sure the parking brake is firmly applied.
3. Place the shift dial in P (Park). With the shift dial in N (Neutral), you cannot start the vehicle.
4. Depress the brake pedal.
5. Press the ENGINE START/STOP button. If the hybrid system starts, the  indicator will come on.

Whether the engine is cold or warm, it should be started without depressing the accelerator.

After following the start procedures,  indicator on the instrument cluster will turn on. For more details, please refer to **"Starting the vehicle" on page 1-29.**

Economical and safe operation of Hybrid system

- Drive smoothly. Accelerate at a moderate rate and maintain a steady cruising speed. Do not make "jackrabbit" starts. Do not race between stoplights. Avoid heavy traffic whenever possible. Always maintain a safe distance from other vehicles so you can avoid unnecessary brak-

ing. This also reduces brake wear out.

- The regenerative brake generates energy when the vehicle decelerates.
- When the hybrid battery power is low, the hybrid system automatically recharges the hybrid battery.
- When the engine is running with the shift dial in N (Neutral), the hybrid system cannot generate electricity. The hybrid battery cannot recharge with the shift dial in N (Neutral).

* NOTICE

In the hybrid system, the engine automatically runs and stops. When the hybrid system operates, the  indicator is illuminated.

In the following situation, the engine may operate automatically.

- When the engine is ready to run.
- When the hybrid battery is being charged.
- Depending on the temperature condition of the hybrid battery.

Changing plug-in hybrid mode (Plug-in hybrid vehicle)

EV/HEV button



Whenever you press the [EV/HEV] button, Plug-in hybrid system drive mode will be changed in sequential as:

Automatic (AUTO) mode - Hybrid (CS) mode - Electric (CD) mode.

Each time the mode is changed a corresponding LED is displayed on the instrument cluster as follows.

Automatic (AUTO) mode

Type A



Type B



Hybrid (CS) mode

Type A







Special features

Hybrid vehicles sound different than petrol engine vehicles. When the hybrid system operates, you may hear a sound from the hybrid battery system behind the rear seat. If you apply the accelerator pedal rapidly, you may hear an unconventional sound. When you apply the brake pedal, you may hear a sound from the regenerative brake system. When the hybrid system is turned off or on, you may hear a sound in the engine compartment. If you depress the brake pedal repeatedly when the hybrid system is turned on, you may hear a sound in the engine compartment. None of these sounds indicate a problem. These are normal characteristics of hybrid vehicles.

It is a normal condition if you hear a motor sound in the engine compartment in any of the following situations:

- The brake pedal is released after turning off the hybrid system.
- The brake pedal is applied when the hybrid system is turned off.
- When the driver door is opened.

When the hybrid system is turned ON, the petrol engine may run or may not. In this situation, you may feel a vibration. This does not indicate a malfunction. When the  indicator illuminates, the hybrid system is ready to begin driving. Even if the engine is off, you can operate the vehicle as long as the  indicator is illuminated.

* NOTICE

The hybrid system contains many electronic components. High voltage components, such as cables and other parts, may emit electromagnetic waves. Even when the electromagnetic cover blocks electromagnetic emissions, electromagnetic waves may have an effect on electronic devices. When your vehicle is not used for a long period of time, the hybrid system will discharge. You need to drive the vehicle several times a month. We recommend driving at least for 1 hour or 16 km. When the hybrid battery is discharged, or when it is impossible

to jump start the vehicle, we recommend that you contact your authorised Kia dealer/service partner.

⚠ WARNING

- When you start the hybrid system with the shift dial in P (Parking), the (P) indicator illuminates on the instrument cluster. The driver can drive the vehicle, even when the petrol engine is off.
- When you leave the vehicle, you should turn OFF the hybrid system or locate the shift dial in P (Park). When you depress the accelerator pedal by mistake, or when the shift dial is not in P (Park), the vehicle will abruptly move, possibly resulting in serious injury or death.

Virtual Engine Sound System (VESS)

Virtual Engine Sound System generates engine sound for pedestrians to hear vehicle sound because there is limited sound whilst motor power is used.

- If the vehicle is moving at low speed, the VESS will operate.
- When the gear is shifted to R (Reverse), an additional warning sound will be heard.

What does regenerative braking do?

It uses an electric motor when decelerating and when braking and transforms kinetic energy to electrical energy in order to charge the high voltage battery.

Battery

- The vehicle is composed of a high voltage battery that drives the motor and air conditioner, and an integrated 12V lead battery with the HEV battery that drives the lamps, wipers, and audio system.
- The integrated 12V battery is automatically charged when the vehicle is in the ready (P) mode.

Hybrid system gauge

Power gauge

Type A



Type B



The hybrid system gauge indicates whether the current driving condition is fuel efficient or not.

- **CHARGE:**
Shows that the energy made by the vehicle is being converted to electrical energy. (Regenerated energy)
- **ECO:**
Shows that the vehicle is being driven in an Eco-friendly manner.
- **POWER:**
Shows that the vehicle is exceeding the Eco-friendly range.

Hybrid battery SOC (State of Charge) gauge

Type A

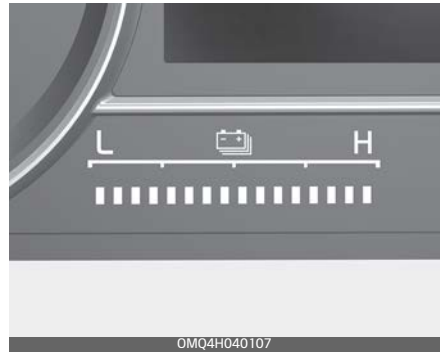

Type B

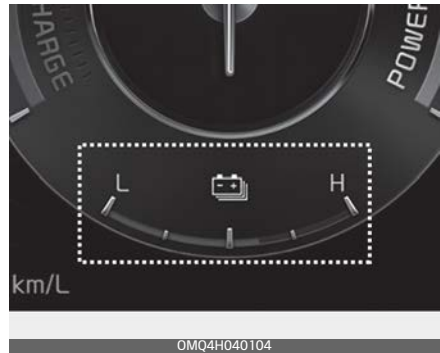

This gauge indicates the remaining hybrid battery power. If the SOC is near the "L (Low)" level, the vehicle automatically operates the engine to charge the battery.

However, if the Service Indicator (⚠️) and Malfunction Indicator Lamp (MIL) (🔧) turn on when the SOC gauge is near the "L (Low)" level, we recommend the vehicle to be checked by an authorised Kia dealer/service partner.

Warning and indicator lights

Ready indicator

This indicator illuminates:

When the vehicle is ready to be driven.

- ON: Normal driving is possible.
- OFF: Normal driving is not possible, or a problem has occurred.
- Blinking: Emergency driving.

When the ready indicator goes OFF or blinks, there is a problem with the system. If this occurs, we recommend that you have your vehicle inspected by an authorised Kia dealer/service partner.

Service warning light

This warning light illuminates:

- When you set the ENGINE START/STOP button to the ON position.
 - The service warning light illuminates for approximately 3 seconds and then turns off when all checks have been performed.
- When there is a problem with the hybrid vehicle control system or hardware.

When the warning light illuminates whilst driving, or does not go OFF after starting the vehicle, we recommend that you have the vehicle inspected by an authorised Kia dealer/service partner.

EV mode indicator

This indicator illuminates:

When the vehicle is driven by the electric motor.

- "EV" indicator ON: Vehicle is driven using the electric motor or the petrol engine is stopped.
- "EV" indicator OFF: Vehicle is driven using the petrol engine.

Regenerative brake warning light

 (red colour)  (yellow colour)

This warning light illuminates:

When the regenerative brake does not operate and the brake does not perform well. This causes the brake warning light (red) and regenerative brake warning light (yellow) to illuminate simultaneously.

If this occurs, drive safely and have your vehicle inspected by an authorised Kia dealer/service partner. The operation of the brake pedal may be more difficult than normal and the braking distance may increase.

Charging cable connection indicator

 (Plug-in hybrid vehicle)

This indicator illuminates in red when the charging cable is connected.

LCD display messages

Ready to start driving



This message is displayed when the vehicle is ready to be driven.

Check regenerative brakes

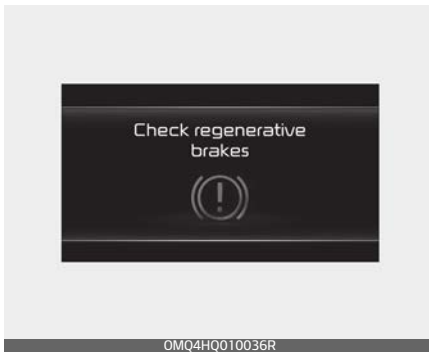

This message is displayed when the brake performance is low or the regenerative brake does not work properly due to a failure in the brake system.

If this occurs, it may take longer for the brake pedal to operate and the braking distance may become longer.

Stop vehicle and check brakes



This message is displayed when a failure occurs in the brake system.

If this occurs, park the vehicle in a safe location and we recommend that you tow your vehicle to the nearest authorised Kia dealer/service partner and have the vehicle inspected.

Check Hybrid system

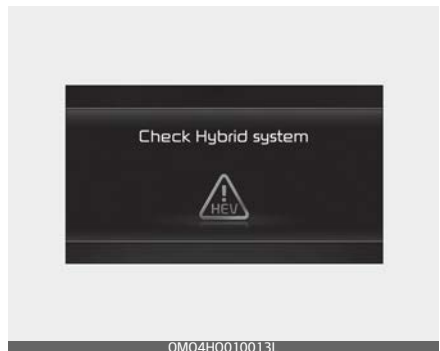

This message is displayed when there is a problem with the hybrid control system. Refrain from driving when the warning message is displayed.

If this occurs, we recommend that you have the vehicle inspected by an authorised Kia dealer/service partner.

Stop safely and check Hybrid system

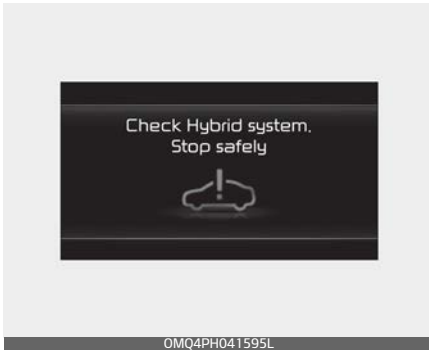

This message is displayed when there is a problem with the hybrid control system. The "!" indicator will blink and a warning chime will sound until the problem is solved. Refrain from driving when the warning message is displayed.

If this occurs, we recommend that you have the vehicle inspected by an authorised Kia dealer/service partner.

Check Hybrid system. Do not start engine



This message is displayed when the hybrid battery power (SOC) level is low. A warning chime will sound until the problem is solved. Refrain from driving when the warning message is displayed.

If this occurs, we recommend that you have the vehicle inspected by an authorised Kia dealer/service partner.

Stop safely and check power supply



This message is displayed when a failure occurs in the power supply system.

If this occurs, park the vehicle in a safe location and tow your vehicle to the nearest authorised Kia dealer/service partner and have the vehicle inspected.

Check Virtual Engine Sound System



This message is displayed when there is a problem with the Virtual Engine Sound System (VESS).

If this occurs, we recommend that you have the vehicle inspected by an authorised Kia dealer/service partner.

Refill inverter coolant



This message is displayed when the inverter coolant is nearly empty.

You should refill the inverter coolant.

Park with engine On to charge battery





This message is displayed when the hybrid battery power (SOC) level is low.

If this occurs, park the vehicle in a safe location and wait until the hybrid battery is charged.

Start engine to avoid battery discharge



This message is displayed to inform the driver the 12V battery may be discharged if the ENGINE START/ STOP button is in ON position (without the  indicator ON).

Set the vehicle to the ready () mode to prevent the 12V battery from being discharged.

CD (Charge Depleting, Electric) mode (Plug-in hybrid vehicle)



The high-voltage (hybrid) battery is used to drive the vehicle.

AUTO (Automatic) mode (Plug-in hybrid vehicle)

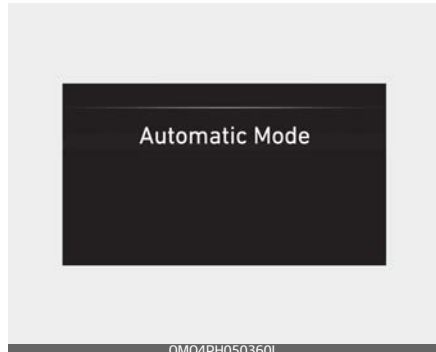

The drive mode will be automatically selected from either Electric (CD) mode or Hybrid (CS) mode by the system according to the driving condition.

CS (Charge Sustaining, Hybrid) mode (Plug-in hybrid vehicle)

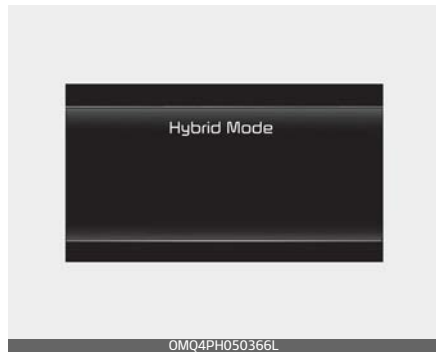

The high-voltage (hybrid) battery and petrol engine is used to drive the vehicle.

Remaining charge time (Plug-in hybrid vehicle)



OMQ4PHQ010048L

The message is displayed to notify the remaining time to fully charge the battery.

Charging stopped. Check the AC charger (Plug-in hybrid vehicle)

This messages is displayed when the charging failed by external charger error.

The purpose of this message is to let you know the error has occurred in the charger itself, not in the vehicle.

Charging stopped. Check the cable connection (Plug-in hybrid vehicle)

This messages is displayed when charging is stopped because the charging connector is not correctly connected to the charging inlet. If this occur, separate the charging connector and re-connect it and check whether there is any problem (external damage, foreign sub-

stances, etc.) with the charging connector and charging inlet. If the same problem occurs when charging the vehicle with a replaced charging cable or genuine Kia portable charger, have the vehicle inspected by a professional workshop. Kia recommends to visit an authorised Kia dealer/service partner.

Low/High System Temp. Maintaining Hybrid mode (Plug-in hybrid vehicle)

This message is displayed when the temperature of the high-voltage (hybrid) battery is too low or too high.

This warning message is to protect the battery and the hybrid system.

Low/High System Temp. Switching to Hybrid mode (Plug-in hybrid vehicle)

This message is displayed when the temperature of the high-voltage (hybrid) battery is too low or high.

This warning message is to protect the battery and the hybrid system.

Switching to Hybrid mode to allow heating (Plug-in hybrid vehicle)

- When the outdoor temperature is lower than $-15\text{ }^{\circ}\text{C}$ ($5\text{ }^{\circ}\text{F}$) and the coolant temperature is lower than $70\text{ }^{\circ}\text{C}$ ($158\text{ }^{\circ}\text{F}$), you turn the climate control On for heating, the

above message will be displayed in the cluster. Then, the vehicle will automatically switch to HEV mode and EV mode will not be activated (although EV/HEV button is pressed)

- When the outdoor temperature is higher than $-10\text{ }^{\circ}\text{C}$ ($14\text{ }^{\circ}\text{F}$), or the coolant temperature is higher than $80\text{ }^{\circ}\text{C}$ ($176\text{ }^{\circ}\text{F}$) or you turn the climate control Off, the vehicle will automatically return to EV mode.

Wait until fuel door unlocks (Plug-in hybrid vehicle)

The message is displayed when you attempt to unlock the fuel filler door with the fuel tank pressurised. Wait until the fuel tank is depressurised.

*** NOTICE**

- It may take up to 20 seconds to unlock fuel filler door.
- If the fuel filler door does not open because ice has formed around it, tap lightly or push on the door to break the ice and release the door.
- Do not pry on the door. If necessary, spray around the door with an approved de-icer fluid (do not use radiator anti-freeze) or move the vehicle to a warm place and allow the ice to melt.

Fuel door unlocked (Plug-in hybrid vehicle)

This message is displayed when the fuel filler door is unlocked.

Also means "Ready to refuel".

Please press the rear centre edge of fuel filler door to open.

Check fuel door (Plug-in hybrid vehicle)

This message is displayed when the fuel filler door is open whilst driving or an abnormality has occurred.

Charging door open (Plug-in hybrid vehicle)

This message indicates that the charging door is open whilst in driving ready state to encourage you to inspect and close the door.

(Driving with the charging door open may result in moisture inflow or damage. This message is used to prevent such occurrences.)

Unplug vehicle to start (Plug-in hybrid vehicle)

The message is displayed when you start the engine without unplugging the charging cable. Unplug the charging cable, and then start the vehicle.

Maintaining Hybrid mode to continue heating (Plug-in hybrid vehicle)

A message is displayed when heating is in operation and the HEV mode is maintained to meet the heating operating conditions when attempting to switch to EV mode by pressing the EV/HEV button.

EV/HEV modes (Plug-in hybrid vehicle)

A corresponding message is displayed when a mode is selected by pressing the EV/HEV button.

PHEV infotainment system (Plug-in hybrid vehicle)

Press [PHEV] on the [Home screen].



OMQ4PH040493L

The Plug-in Hybrid menu consists of five sections: [EV range], [Energy information], [Charge management], [ECO driving], [Energy flow].



OMQ4PH040492L

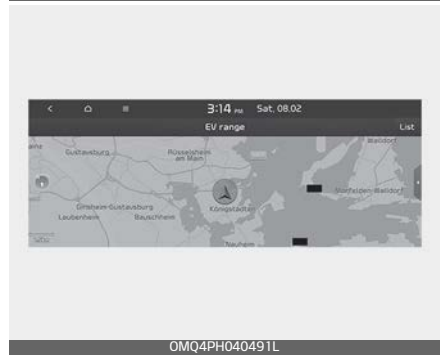

OMQ4PH040491L

For more information, please refer to the infotainment manual that was separately supplied with your vehicle.

Energy flow

The hybrid system informs the drivers its energy flow in various operating modes. Whilst driving, the current energy flow is specified in 11 modes.

Vehicle stop

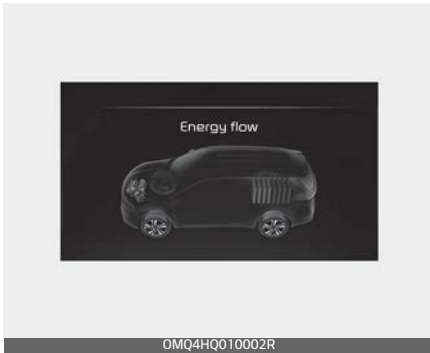

The vehicle is stopped.
(No energy flow)

EV propulsion

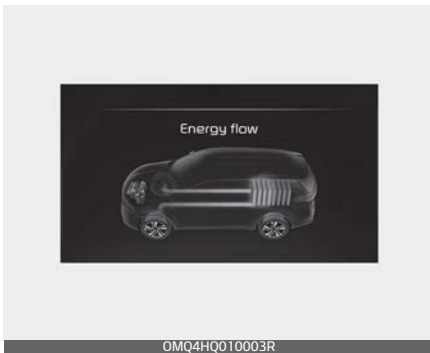

Only the motor power is used to drive the vehicle.
(Battery → Wheel)

Power assist

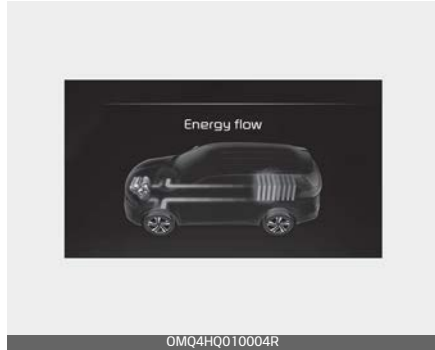

Both the motor and the engine power are used to drive the vehicle.
(Battery & Engine → Wheel)

Engine only propulsion

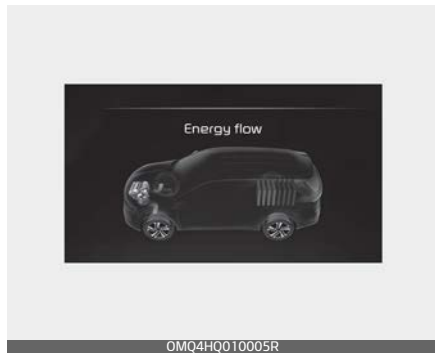

Only the engine power is used to drive the vehicle.
(Engine → Wheel)

Engine generation

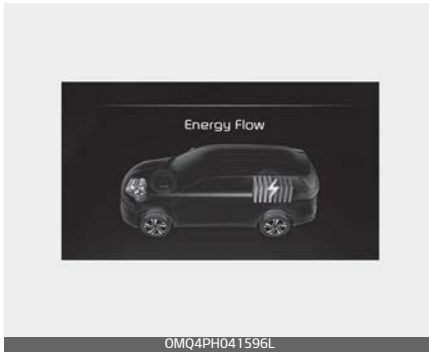

When the vehicle is stopped, the high-voltage battery is charged up by the engine.
(Engine → Battery)

Regeneration



The high-voltage battery is charged up by the regenerative brake system.
(Wheel → Battery)

Engine brake

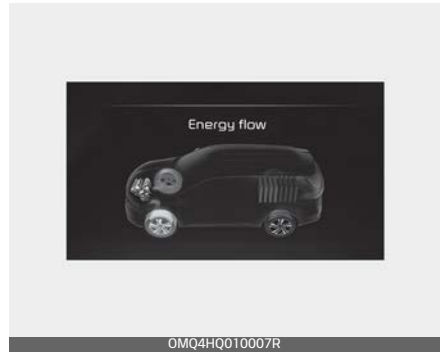

The engine braking is used to decelerate the vehicle.
(Wheel → Engine)

Power reserve

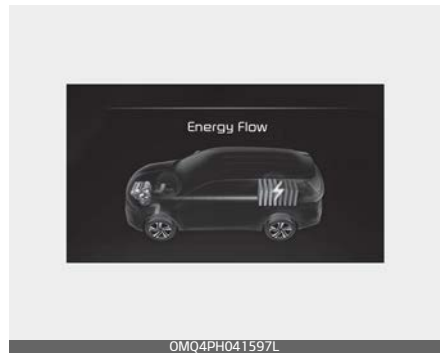

The engine is simultaneously used to drive the vehicle and to charge up the high-voltage battery.
(Engine → Wheel & Battery)

Engine generation/motor drive

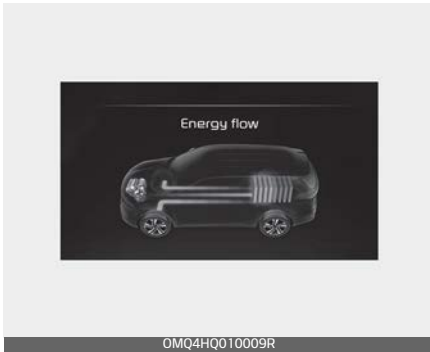

The engine charges up the high-voltage battery. The motor power is used to drive the vehicle.
 (Engine → Battery → Wheel)

Engine brake/regeneration



The engine braking is simultaneously used to decelerate the vehicle and to charge up the high-voltage battery.
 (Wheel → Engine & Battery)

Engine generation/regeneration

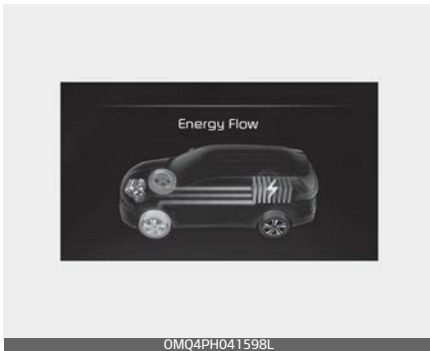

The engine and regenerative brake system charges up the high-voltage battery.
 (Engine & Wheel → Battery)

Start engine to avoid battery discharge



If the engine is not turned on with the ENGINE START/STOP button in ACC or ON for a whilst, the battery can be discharged. Please turn on the engine to prevent 12V battery from discharge.

Aux. Battery Saver+ (Plug-in hybrid vehicle) (if equipped)

The Aux. Battery Saver+ is a function that monitors the charging status of the 12V auxiliary battery. If the auxiliary battery level is low, the main high voltage battery charges the auxiliary battery.

*** NOTICE**

The Aux. Battery Saver+ function will be ON when the vehicle is delivered. If the function is not needed, you may turn it off in the Users Settings mode on the LCD display. For more information, refer to the "System setting" on the following page.

Mode

- Cycle Mode: When the vehicle is OFF with all doors, bonnet and tailgate closed, the Aux. Battery Saver+ periodically activates according to the auxiliary battery status.
- Automatic Mode: When the ENGINE START/STOP button is in the ON position with the charging connector plugged in, the function activates according to the auxiliary battery status to prevent over-discharge of the auxiliary battery.

⚠ CAUTION

- The Aux. Battery Saver+ activates for a maximum of 20 minutes. If the Aux. Battery Saver+ function activates more than 10 times consecutively, in the Automatic Mode the function will stop activating, judging that there is a problem with the auxiliary battery. In this case, drive the vehicle for some period of time. The function will start activating if the auxiliary battery returns to normal.
- The Aux. Battery Saver+ function cannot prevent battery discharge if the auxiliary battery is damaged, worn out, used as a power supply or unauthorised electronic devices are used.

System setting

The driver can activate the Aux. Battery Saver+ function by placing the ENGINE START/STOP button to the ON position and by selecting: "User Settings → Other Features → Aux. Battery Saver+"

⚠ WARNING

When the function is activating the charging indicator lamp will quickly blink and high voltage electricity will be flowing in the vehicle. Do not touch the high voltage electric wire (orange), connector, and all electric components and devices. This may cause electric shock and lead to injuries. Also, do not modify your vehicle in any way. This may affect your vehicle performance and lead to an accident.



Components of the hybrid/plug-in hybrid vehicle

Plug-in hybrid vehicle components

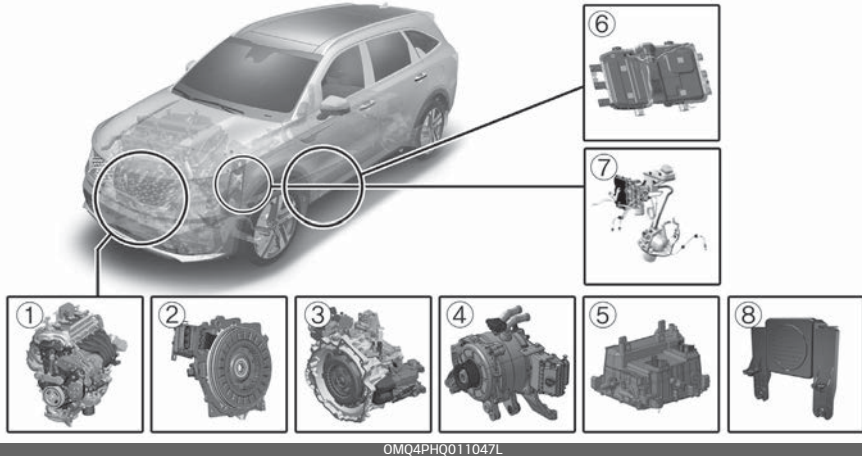

* The actual shape may differ from the illustration.

1. Engine: 1.6 L
2. Motor: 66.9 kW
3. Transmission: 6 AT
4. Hybrid starter generator (HSG)
5. HPCU (Hybrid Power Control Unit)
6. High voltage battery system
7. Regenerative brake system
8. Virtual Engine Sound System (VESS)

Hybrid system overview

The Hybrid battery uses high voltage to operate the electric motor and other components. High voltage is dangerous if touched.

Your vehicle is equipped with orange coloured insulation and covers over the high voltage components to protect people from electric shock. High voltage warning labels are attached to some system components as additional warnings. Have your vehicle serviced by a professional workshop. Kia recommends to visit an authorised Kia dealer/service partner.

HPCU (Hybrid Power Control Unit) *1

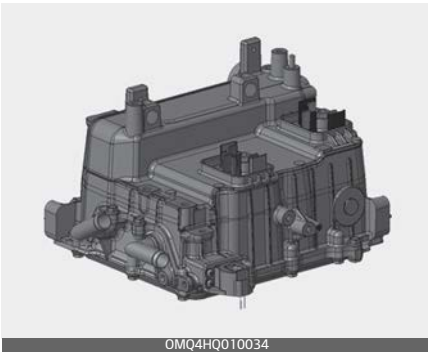

Components of the hybrid/plug-in hybrid vehicle

High voltage battery system *2



* 1: Located in the engine compartment

* 2: Located under the 1st row seats

⚠ WARNING

Never touch orange coloured or high voltage labeled components, including wires, cables, and connections. When the insulators or covers are damaged or removed, severe injury or death from electrocution may occur.

⚠ WARNING

Whilst replacing the fuses in the engine compartment, never touch the HPCU. The HPCU carries high voltage. Touching the HPCU may result in electrocution, serious injury, or death.

⚠ WARNING

In the hybrid system, the hybrid battery uses high voltage to operate the motor and other components. This high voltage hybrid battery system can be very dangerous.

Never touch the hybrid system. When you touch the hybrid battery system, serious injury or death may occur.

⚠ CAUTION

- Be careful when loading flammable liquid in the passenger compartment. It could cause operational and safety degradation if the liquid leaks and flows in the high voltage battery.

Drive motor *3



OMQ4HQ010033

* 3: Located in the engine compartment

⚠ WARNING

As with all batteries, avoid fluid contact with the hybrid battery. If the battery is damaged and if electrolyte comes in contact with your body, clothes or eyes, immediately flush with a large quantity of fresh water.

⚠ WARNING

Do not use an after-market battery charger to charge the hybrid battery. Doing so may result in death or serious injury.

⚠ WARNING

High waters

- Avoid high waters as this may result in your vehicle becoming saturated with water and could compromise the high voltage components.
- Do not touch any of the high voltage components within your vehicle if your vehicle has been submerged in water equal to half of the vehicle height. Touching high voltage components once submerged in water could result in severe burns or electric shock that could result in death or serious injury.

⚠ WARNING

Carrying liquids in tailgate

Do not load large amounts of water in open containers into the vehicle. If the water spills onto the HEV battery, it may cause a short and damage the battery.

⚠ CAUTION

Cleaning engine

When you clean the engine compartment, do not wash using water. Water may cause electric arcing to occur and damage electronic parts and components.

⚠ WARNING

Exposure to high voltage

- High voltage in the hybrid battery system is very dangerous and can cause severe burns and electric shock. This may result in serious injury or death.
 - For your safety, never touch, replace, dismantle or remove any portion of the hybrid battery system including components, cables and connectors.
-

⚠ WARNING

Use of water or liquids

If water or liquids come into contact with the hybrid system components, and you are also in contact with the water, severe injury or death due to electrocution may occur.

⚠ WARNING

Hot components

When the hybrid battery system operates, the HEV battery system can be hot. Heat burns may result from touching even insulated components of the HEV system.

⚠ CAUTION

Prolonged parking

Prolonged parking might cause battery discharge and operation failure due to natural discharge. Driving the vehicle approximately once every 2 months, more than 15 km (9 mi.) is recommended. The battery will be charged automatically when driving the vehicle.

Hybrid vehicle components

High voltage battery system

HPCU (Hybrid Power Control Unit) *1

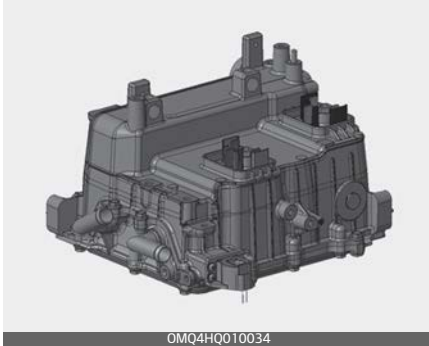

OMQ4HQ010034

High voltage battery system *2



OMQ4HQ010032

* 1: Located in the engine compartment

* 2: Located under the 1st row seats

⚠ WARNING

Never touch orange coloured or high voltage labeled components, including wires, cables, and connections. When the insulators or covers are damaged or removed, severe injury

or death from electrocution may occur.

⚠ WARNING

Whilst replacing the fuses in the engine compartment, never touch the HPCU. The HPCU carries high voltage. Touching the HPCU may result in electrocution, serious injury, or death.

⚠ WARNING

In the hybrid system, the hybrid battery uses high voltage to operate the motor and other components. This high voltage hybrid battery system can be very dangerous.

Never touch the hybrid system. When you touch the hybrid battery system, serious injury or death may occur.

⚠ CAUTION

- Do not pile up any items in an area behind the high voltage battery. In a crash, the battery may become unstable, or its performance may degrade.
- Do not apply strong force nor pile up any items above the luggage compartment. Such an attempt may distort the high voltage battery case, causing a safety prob-

lem or degrading the performance.

- Be careful when loading flammable liquid in the luggage compartment. It could cause operational and safety degradation if the liquid leaks and flows in the high voltage battery.

Drive motor *3



OMQ4HQ010033

- * 3: Located in the engine compartment

⚠ WARNING

- Do not disassemble the high voltage motor connector. The high voltage motor connector may contain residual high voltage. Coming in contact with high voltage may result in death or serious injury.
- Your vehicle's hybrid system should only be inspected or repaired by an authorised Kia dealer/service partner.

⚠ WARNING

- Do not disassemble or assemble the high voltage battery system. Doing so may result in electric shock, causing death or serious injury.
- If you disassemble or assemble hybrid system components improperly, it may damage the performance and reliability of your vehicle.
- If electrolyte comes in contact with your body, clothes or eyes, immediately flush with a large quantity of fresh tap water. Have your eyes examined by a doctor as soon as possible.

⚠ WARNING

Never assemble or disassemble the high voltage battery system.

- If you assemble or disassemble the high voltage battery system, the durability and performance of the vehicle may be damaged.
- When you want to check the high voltage battery system, Kia recommends to visit an authorised Kia dealer/service partner.
- Do not touch the high voltage battery and high voltage cable connected to motor (orange colour). Severe burns and electric shock may occur. For your safety, do not touch the cover of electronic components and electronic

cable. Do not remove the cover of electronic components and electronic cable. In particular, never touch the high voltage battery system when the hybrid system is in operation. It may result in death or serious injury.

⚠ WARNING

- Never use the package modules (high voltage battery, inverter and converter) for any other purpose.
- Do not use an unauthorised battery charger to charge the high voltage battery. Doing so may result in death or serious injury.
- Never locate the high voltage system near or in a fire.
- Never drill into or strike the package module. Otherwise, it may be damaged. An electric shock may occur, resulting in serious injury or death.

*** NOTICE**

- When the vehicle is paint baked, do not bake over 30 minutes in 70°C (158°F) or 20 minutes in 80°C (176°F) degree.
- Do not wash the engine compartment, using water. Water may cause an electric shock and damage the electronic components.

⚠ WARNING

This hybrid vehicle uses the hybrid battery system inverter and converter to generate high voltage. High voltage in the hybrid battery system is very dangerous and may cause severe burns and electric shock. This may result in serious injury or death.

- For your safety, never touch, replace, disassemble or remove the hybrid battery system including components, cables and connectors. Severe burns or electric shock may result in serious injury or death when you fail to follow this warning.
- When the hybrid battery system operates, the hybrid battery system can be hot. Always be careful because burns or electric shock may be caused by high voltage.
- Do not spill liquid on the HPCU, HSG, motor and fuses. If the hybrid system components come in contact with liquid, it may result in electric shock.

Hybrid battery cooling duct (Hybrid vehicle)

Inlet duct



Outlet duct



The hybrid battery cooling duct is located below the right side of the front seats. The cooling duct cools down the hybrid battery. When the hybrid battery cooling duct is blocked, the hybrid battery may be overheated.

Clean the cooling duct for the hybrid battery with a dry cloth on a regular basis.

⚠ WARNING

- Never clean the cooling duct of the hybrid battery with a wet cloth. If any water enters the cooling duct of the hybrid battery, the hybrid battery may cause an electric shock, resulting in a serious damage, an injury or a death.
- The hybrid battery is composed of lithium-ion polymer. If the hybrid battery is improperly handled, it is dangerous to the environment. Also it may cause electrical shock and severe burns, resulting in a serious injury or a death.
- Do not spill liquid over the cooling duct of the hybrid battery. Doing so is very dangerous. It may cause electric shock or serious injury.
- Do not cover the cooling duct with objects.
- Do not put any objects into the cooling duct of the hybrid battery. Doing so may cause loss of cooling duct volume to the hybrid battery. When the cooling duct is blocked with any objects, immediately contact your Kia dealer.
- Never place a container of liquid on or near the cooling duct. If the liquid spills, the hybrid battery located in the luggage compartment may be damaged.
- Secure all loads in the luggage compartment to prevent them from being tossed about before

driving. When a sharp or heavy load strike with a strong impact or pierce the interior luggage compartment wall, the hybrid battery system may be damaged, deteriorating its performance.

- Do not obstruct the cooling duct with any other objects.

Service interlock connector

⚠ DANGER

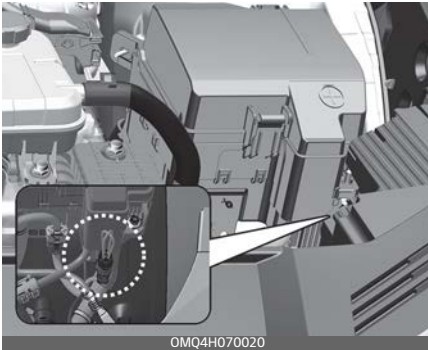

In case of emergency, cut the service interlock connector cable to isolate the high voltage of the battery.

⚠ WARNING

Never disconnect the service interlock connector or cut the wire except in an emergency situation. Serious problems may occur, such as the vehicle will not start.

If an accident occurs

⚠ WARNING

- For your safety, do not touch the high voltage cables, connectors and package modules. High voltage components are orange in colour.
- Exposed cables or wires may be visible inside or outside of the vehicle. Never touch the wires or cables, because an electrical shock, an injury, or a death may occur.
- Any gas or electrolyte leakage from your vehicle is not only poisonous but also flammable. Upon witnessing one of those, open the windows, and remain a safe distance from the vehicle out of the road. Immediately call an emergency services or contact an authorised Kia dealer and advise them that a hybrid vehicle is involved.
- When the vehicle is severely damaged, remain a safe distance of 15 metre or more between your vehicle and other vehicles/ flammables.

⚠ WARNING

If a fire occurs:

- If a small scale fire occurs, use a fire extinguisher (ABC, BC) that is meant for electrical fires.

If it is impossible to extinguish the fire in the early stage, remain a safe distance from the vehicle and immediately call your local fire emergency responders. Also, advise them that a hybrid vehicle is involved.

If the fire spreads to the high voltage battery, large amount of water is needed to put out the fire.

Using small amount of water or fire extinguishers not meant for electrical fires could cause serious injury or death from electrical shocks.

- Upon witnessing any sparks, gases, flames, or fuel leakage of your vehicle, immediately call emergency services or contact an authorised Kia dealer/service partner. Also, advise them that a hybrid vehicle is involved.

⚠ WARNING

When a submersion in water occurs: When your vehicle is flooded in water, a high-voltage battery may cause shock or fires. Thus, turn the hybrid system OFF, take the key in your possession and escape to a safe place. Never attempt physical contact with your flooded vehicle. Immediately contact an authorised Kia dealer and advise them that a hybrid vehicle is involved.

When the hybrid vehicle shuts off

When the high voltage battery or 12 volt battery is discharged, or when the fuel tank is empty, the hybrid system may not operate whilst driving. When the Hybrid system does not operate, do the followings:

1. Gradually reduce the vehicle speed. Pull over your vehicle off the road in a safe area.
2. Locate the shift dial in P (Park).
3. Turn ON the hazard warning flashers.
4. Turn OFF the vehicle, and try to start the hybrid system again, whilst depressing the brake pedal and turning on the ENGINE START/STOP button.
5. When the hybrid system still does not operate, refer to "Emergency starting" on page 7-6. Before jump-starting the vehicle, check the fuel level and the exact procedure to jump start. When the fuel level is low, do not attempt to drive the vehicle only with the battery power. The high voltage battery may be discharged, and the hybrid system will turn OFF.

⚠ WARNING

Accident Vehicle

Never touch electric wires or cable. If exposed electric wires or cables are visible inside or outside of your vehicle, an electric shock may occur.

⚠ WARNING**Putting out fire**

Never use a small quantity of water to put out a fire in your vehicle. If a fire occurs, evacuate the car immediately and contact the fire department.

Fuel requirements	2-2
Vehicle modifications	2-4
Vehicle break-in process	2-5
Risk of burns when parking or stopping vehicle.....	2-5
Vehicle handling instructions	2-6
HEV/PHEV powertrain	2-6

Introduction

Fuel requirements

Unleaded

For the optimal vehicle performance, we recommend you to use unleaded petrol with an octane rating of RON (Research Octane Number) 95/AKI (Anti Knock Index) 91 or higher.

You may use unleaded petrol with an octane rating of RON 91 ~ 94/AKI 87 ~ 90 but it may result in slight performance reduction of the vehicle. (Do not use methanol blended fuels.)

⚠ CAUTION

NEVER USE LEADED FUEL. The use of leaded fuel is detrimental to the catalytic converter and will damage the engine control system's oxygen sensor and affect emission control. Never add any fuel system cleaning agents to the fuel tank other than what has been specified. (Kia recommends to consult an authorised Kia dealer/service partner for details.)

⚠ WARNING

- Do not "top off" after the nozzle automatically shuts off when refuelling.
- Always check that the fuel cap is installed securely to prevent fuel spillage in the event of an accident.

Petrol containing alcohol and methanol

Gasohol, a mixture of petrol and ethanol (also known as grain alcohol), and petrol or gasohol containing methanol (also known as wood alcohol) are being marketed along with or instead of leaded or unleaded petrol.

Do not use gasohol containing more than 10% ethanol, and do not use petrol or gasohol containing any methanol. Either of these fuels may cause drivability problems and damage to the fuel system, engine control system and emission control system.

Discontinue using gasohol of any kind if drivability problems occur.

Vehicle damage or drivability problems may not be covered by the manufacturer's warranty if they result from the use of:

1. Gasohol containing more than 10% ethanol.

2. Petrol or gasohol containing methanol.
3. Leaded fuel or leaded gasohol.

⚠ CAUTION

Never use gasohol which contains methanol. Discontinue use of any gasohol product which impairs drivability.

Other fuels

Using fuels such as

- Silicone (Si) contained fuel,
- MMT (Methylcyclopentadienyl Manganese Tricarbonyl), Manganese (Mn) contained fuel
- Ferrocene (Fe) contained fuel, and
- Other metallic additives contained fuels,

may cause vehicle and engine damage or cause plugging, misfiring, poor acceleration, engine stalling, catalyst melting, abnormal corrosion, life cycle reduction, etc.

Also, the Malfunction Indicator Lamp (MIL) may illuminate.

* NOTICE

Damage to the fuel system or performance problem caused by the use of these fuels may not be covered by your New Vehicle Limited Warranty.

Use of MTBE

Kia recommends avoiding fuels containing MTBE (Methyl Tertiary Butyl Ether) over 15.0% vol. (Oxygen Content 2.7% weight) in your vehicle.

Fuel containing MTBE over 15.0% vol. (Oxygen Content 2.7% weight) may reduce vehicle performance and produce vapour lock or hard starting.

⚠ CAUTION

Your New Vehicle Limited Warranty may not cover damage to the fuel system and any performance problems that are caused by the use of fuels containing methanol or fuels containing MTBE (Methyl Tertiary Butyl Ether) over 15.0% vol. (Oxygen Content 2.7% weight.)

Do not use methanol

Fuels containing methanol (wood alcohol) should not be used in your vehicle. This type of fuel can reduce vehicle performance and damage components of the fuel system, engine control system and emission control system.

Fuel additives

Kia recommends that you use unleaded petrol which has an octane rating of RON (Research Octane Number) 95 / AKI (Anti Knock Index) 91 or higher (for Europe) or Octane Rating of RON (Research Octane Number) 91 / AKI (Anti-Knock Index) 87 or higher (except Europe).

For customers who do not use good quality petrols including fuel additives regularly, and have problems starting or the engine does not run smoothly, one bottle of additives should be added to the fuel tank when the engine oil is replaced.

Additives are available from a professional workshop along with information on how to use them. Kia recommends to visit an authorised Kia dealer/service partner.

Operation in foreign countries

If you are going to drive your vehicle in another country, be sure to:

- Observe all regulations regarding registration and insurance.
- Determine that acceptable fuel is available.

Vehicle modifications

This vehicle should not be modified. Modification of your vehicle could affect its performance, safety or durability and may even violate governmental safety and emissions regulations.

In addition, damage or performance problems resulting from any modification may not be covered under warranty.

- If you use unauthorised electronic devices, it may cause the vehicle to operate abnormally, wire damage, battery discharge and fire. For your safety, do not use unauthorised electronic devices.

Vehicle break-in process

By following a few simple precautions for the first 6,000 km (4,000 miles) you may increase the performance, economy and life of your vehicle.

- Do not race the engine.
- Whilst driving, keep your engine speed (rpm, or revolutions per minute) within 3,000 rpm.
- Do not maintain a single speed for long periods of time, either fast or slow. Varying engine speed is needed to properly break-in the engine.
- Avoid hard stops, except in emergencies, to allow the brakes to seat properly.
- Don't tow a trailer during the first 2,000 km (1,200 miles) of operation.
- Fuel economy and engine performance may vary depending on vehicle break-in process and be stabilized after 6,000 km (4,000 miles). New engines may consume more oil during the vehicle break-in period.

Risk of burns when parking or stopping vehicle

- Do not park or stop the vehicle near flammable items such as leaves, paper, oil, and tyre. Such items placed near the exhaust system can become a fire hazard.
- When an engine idles at a high speed with the rear side of the vehicle touching the wall, heat of the exhaust gas can cause discolouration or fire. Keep enough space between the rear part of the vehicle and the wall.
- Be sure not to touch the exhaust/catalytic systems whilst engine is running or right after the engine is turned off. There is a risk of burns since the systems are extremely hot.

Vehicle handling instructions

As with other vehicles of this type, failure to operate this vehicle correctly may result in loss of control, an accident or vehicle rollover.

Specific design characteristics (higher ground clearance, track, etc.) give this vehicle a higher centre of gravity than other types of vehicles. In other words they are not designed for cornering at the same speeds as conventional 2-wheel drive vehicles.

Avoid sharp turns or abrupt manoeuvres. Again, failure to operate this vehicle correctly may result in loss of control, an accident or vehicle rollover.

Be sure to read the "Reducing the risk of a rollover" on page 6-220.

HEV/PHEV powertrain

By following a few simple precautions for the first 6,000 km (4,000 miles) you may increase the performance economy and life of your vehicle.

- Do not race the engine.
- Avoid hard stops, except in emergencies, to allow the brakes to seat properly.

Your vehicle at a glance **3**

Exterior overview.....	3-2
Interior overview.....	3-5
Instrument panel overview	3-7
Engine compartment	3-9

Your vehicle at a glance

Exterior overview

Front view



OMQ4PH011007R

* The actual shape may differ from the illustration.

- | | |
|----------------------------------|-------------|
| 1. Bonnet | 5-49 |
| 2. Head lamp | 5-138, 8-81 |
| 3. Wheel and tyre | 7-10, 9-7 |
| 4. Outside rear view mirror | 5-66 |
| 5. Panorama sunroof | 5-56 |
| 6. Front windscreen wiper blades | 5-147, 8-42 |
| 7. Windows | 5-43 |
| 8. Front ultrasonic sensor | 5-132 |
| 9. Front radar | 6-78 |
| 10. Front view camera | 6-65, 6-78 |
| 11. Front fog lamp | 8-82 |

12.Roof rack

5-194

13.Charging door

1-4

Rear view



OMQ401 I002R

* The actual shape may differ from the illustration.

- | | |
|---------------------------|------------------|
| 1. Doors | 5-18 |
| 2. Fuel filler door | 5-51 |
| 3. Rear combination lamp | 8-85, 8-83, 8-84 |
| 4. High mounted stop lamp | 8-87 |
| 5. Tailgate | 5-29, 5-32, 5-39 |
| 6. Antenna | 5-196 |
| 7. Rear view camera | 5-119 |
| 8. Rear ultrasonic sensor | 5-128, 5-132 |
| 9. Rear wiper | 5-147, 8-42 |
| 10. Reversing lamp | 8-86 |
| 11. Rear fog lamp | 8-87 |

Interior overview

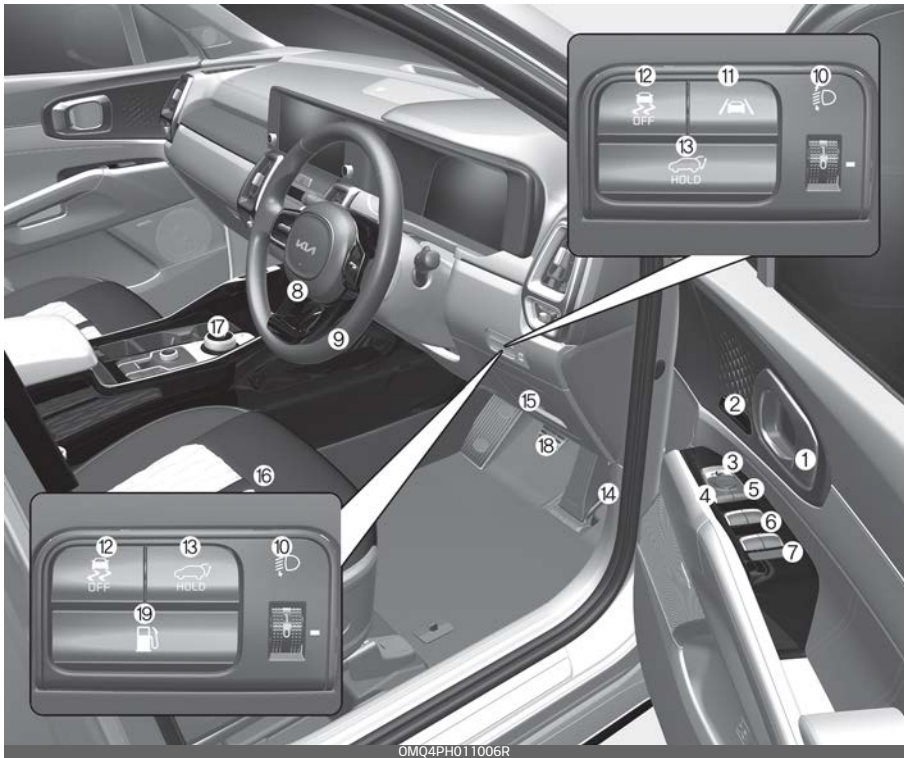

OMQ4PH011006R

* The actual shape may differ from the illustration.

- | | |
|-------------------------------------------|-------|
| 1. Inside door handle | 5-20 |
| 2. Seat position memory system | 5-27 |
| 3. Outside rearview mirror folding switch | 5-66 |
| 4. Outside rearview mirror control switch | 5-66 |
| 5. Central door lock/unlock switch | 5-20 |
| 6. Power window switches | 5-45 |
| 7. Power window lock button | 5-46 |
| Electronic power child safety lock button | 5-23 |
| 8. Steering wheel tilt/telescopic lever | 5-62 |
| 9. Steering wheel | 5-61 |
| 10. Headlight levelling adjustment switch | 5-146 |
| 11. Lane Safety button | 5-23 |
| 12. ESC OFF button | 6-48 |

13.Power tailgate open/close button	5-29, 5-32, 5-39
14.Bonnet release lever	5-49
15.Instrument panel fuse	8-61
16.Seat	4-3
17.Shift dial	6-17
18.Brake pedal	6-35
19.Fuel door open button	5-52

Instrument panel overview



OMQ4PH011004R

* The actual shape may differ from the illustration.

- | | |
|-------------------------------------------------------|--------------|
| 1. Driving Assist button | 6-142, 6-146 |
| 2. Driver's front air bag | 4-56 |
| 3. Horn | 5-65 |
| 4. Audio remote control button | 5-61 |
| 5. Instrument cluster | 5-71 |
| 6. Light control/turn signals lever | 5-138 |
| Wiper and washer control lever | 5-147 |
| 7. Ignition switch or ENGINE START/STOP button | 6-12, 6-8 |
| 8. Infotainment system | 5-196 |
| 9. Hazard warning flasher switch | 7-3 |
| 10. Climate control system | 5-162 |
| 11. Front seat warmer and air ventilation seat button | 5-180, 5-182 |
| 12. Glove box | 5-177 |

13.Steering wheel heater button	5-63
14.Auto Hold button	6-43
15.DBC switch	6-51
16.EPB switch	6-37
17.Parking/View button	5-119, 5-124
18.Parking Safety button	5-128, 5-132
19.Wireless charging system	5-186
20.Centre console storage box	5-177
21.Power outlet	5-185
22.USB charger	5-183
23.Passenger's front air bag	4-56
24.EV/HEV button	1-30

Engine compartment

Smartstream G1.6 T-GDi HEV

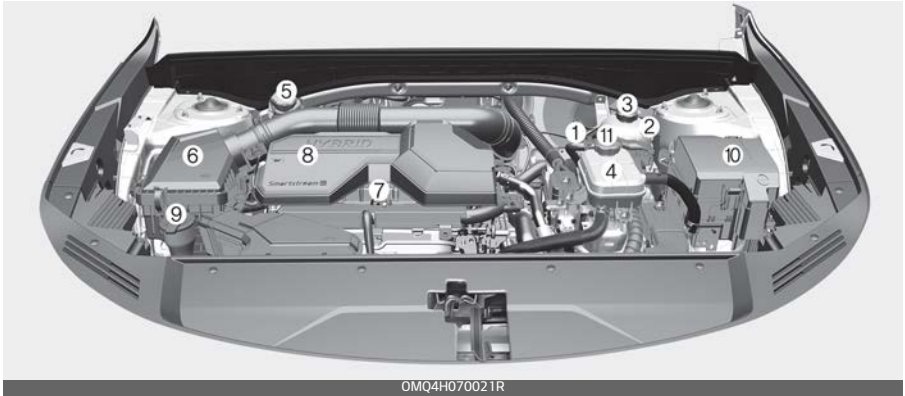

Smartstream G1.6 T-GDi PHEV

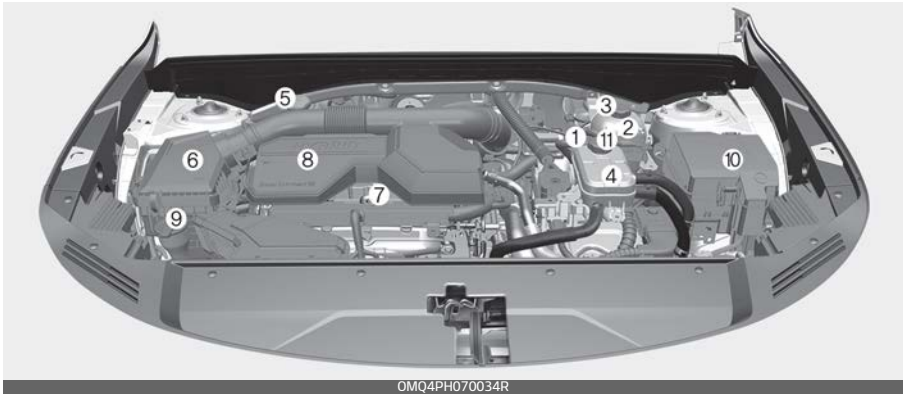

* The actual engine room in the vehicle may differ from the illustration.

- | | |
|--------------------------------------|------|
| 1. Electric Control Unit (ECU) | 8-5 |
| 2. Engine coolant reservoir | 8-31 |
| 3. Engine coolant reservoir cap | 8-31 |
| 4. Inverter coolant reservoir | 8-35 |
| 5. Brake fluid reservoir | 8-37 |
| 6. Air cleaner | 8-41 |
| 7. Engine oil dipstick | 8-29 |
| 8. Engine oil filler cap | 8-29 |
| 9. Windscreen washer fluid reservoir | 8-38 |
| 10. Fuse box | 8-61 |
| 11. Inverter coolant reservoir cap | 8-31 |

Seat	4-3
• Feature of Seat Leather	4-6
• Front seat adjustment for manual seat	4-7
• Front seat adjustment for power seat	4-8
• Headrest (for front seat)	4-11
• Seatback pocket	4-14
• Small pocket (2nd row seat, for 6 passenger vehicle) ...	4-14
• Rear seat adjustment.....	4-15
• Headrest (for rear seat).....	4-21
Seat belts	4-23
• Seat belt restraint system	4-23
• Seat belt precautions.....	4-33
• Care of seat belts	4-35
Child restraint system (CRS)	4-36
• Our recommendation: Children always in the rear	4-36
• Selecting a Child Restraint System (CRS)	4-37
• Installing a Child Restraint System (CRS).....	4-39
ISOFIX anchorage and top-tether anchorage (ISOFIX anchorage system) for children	4-40
• Securing a Child Restraint System with the "ISOFIX Anchorage System"	4-41
• Securing a Child Restraint System seat with "Top-tether Anchorage" system	4-42
• Securing a Child Restraint System with a lap/ shoulder belt.....	4-43
• Suitability of each seating position for belted, i-Size & ISOFIX Child Restraint Systems (CRS) according to UN regulations (Information for use by vehicle users and CRS manufacturers)	4-45

4 Safety features of your vehicle

- Recommended CRS for Vehicle according to UN regulations 4-46
- Air bag – supplemental restraint system..... 4-47**
- How does the air bag system operate 4-48
- Air bag warning and indicator 4-51
- SRS components and functions 4-53
- Driver's and passenger's front air bag..... 4-56
- Passenger's front air bag ON/OFF switch 4-58
- To deactivate or reactivate the passenger's front air bag 4-59
- Side air bag and front centre air bag 4-61
- Curtain air bag..... 4-63
- Air bag collision sensors 4-65
- Why didn't my air bag go off in a collision? (Inflation and non-inflation conditions of the air bag) ... 4-66
- SRS care 4-70
- Additional safety precautions 4-71
- Adding equipment to or modifying your air bag-equipped vehicle 4-72
- Air bag warning labels 4-73

Safety features of your vehicle

Seat

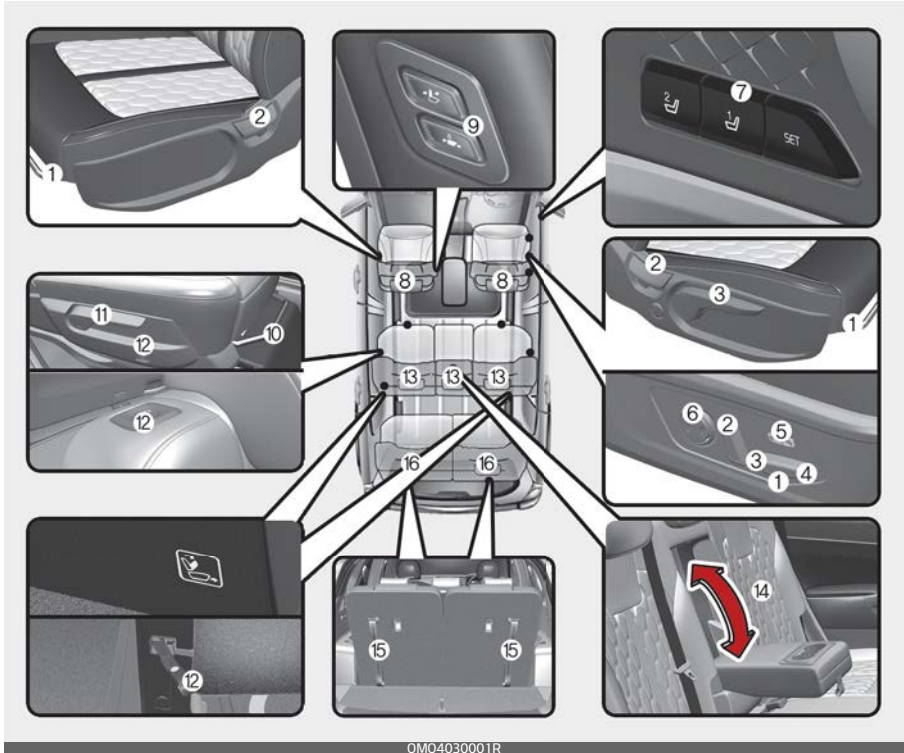

OMQ4030001R

* The actual feature in the vehicle may differ from the illustration.

Front seat

1. Forward and backward
2. Seatback angle
3. Seat cushion height
4. Seat cushion tilt
5. Cushion extension (Driver's seat)
6. Lumbar support
7. Driver position memory system
8. Headrest
9. Walk-in switch (passenger's seat)

2nd row seat

10. Forward and backward
11. Seatback angle and folding
12. Walk-in switch/strap
13. Headrest
14. Armrest

3rd row seat

15. Folding
16. Headrest

⚠ WARNING**Loose objects**

Loose objects in the driver's foot area could interfere with the operation of the foot pedals, possibly causing an accident. Do not place anything under the front seats.

⚠ WARNING**Uprighting seat**

When you return the seatback to its upright position, hold the seatback and return it slowly and be sure there are no other occupants around the seat. If the seatback is returned without being held and controlled, the back of the seat could spring forward resulting in accidental injury to a person struck by the seatback.

⚠ WARNING**Driver responsibility for passengers**

Riding in a vehicle with the seatback reclined could lead to serious or fatal injury in an accident.



If a seat is reclined during an accident, the occupant's hips may slide under the lap portion of the seat belt, applying great force to the unprotected abdomen. Serious or fatal internal injuries could result. The driver must advise the passenger to keep the seatback in an upright position whenever the vehicle is in motion.

⚠ WARNING

Do not use a sitting cushion that reduces friction between the seat and passenger. The passenger's hips may slide under the lap portion of the seat belt during an accident or a sudden stop. Serious or fatal inter-

nal injuries could result because the seat belt can't operate normally.

WARNING

Driver's seat

- Never attempt to adjust the seat whilst the vehicle is moving. This could result in loss of control, and an accident causing death, serious injury, or property damage.
 - Do not allow anything to interfere with the normal position of the seatback. Storing items against a seatback or in any other way interfering with proper locking of a seatback could result in serious or fatal injury in a sudden stop or collision.
 - Always drive and ride with your seatback upright and the lap portion of the seat belt snug and low across the hips. This is the best position to protect you in case of an accident.
 - In order to avoid unnecessary and perhaps severe air bag injuries, always sit as far back as possible from the steering wheel whilst maintaining comfortable control of the vehicle. We recommend that your chest is at least 250 mm (10 inches) away from the steering wheel.
-

WARNING

Rear seatbacks

- The rear seatback must be securely latched. If not, passengers and objects could be thrown forward resulting in serious injury or death in the event of a sudden stop or collision.
 - Luggage and other cargo should be laid flat in the cargo area. If objects are large, heavy, or must be piled, they must be secured. Under no circumstances should cargo be piled higher than the seatbacks. Failure to follow these warnings could result in serious injury or death in the event of a sudden stop, collision or rollover.
 - No passenger should ride in the cargo area or sit or lie on folded seatbacks whilst the vehicle is moving. All passengers must be properly seated in seats and restrained properly whilst riding.
 - When resetting the seatback to the upright position, make sure it is securely latched by pushing it forward and backwards.
 - To avoid the possibility of burns, do not remove the carpet in the cargo area. Emission control devices beneath this floor generate high temperatures.
-

⚠ WARNING

After adjusting the seat, always check that it is securely locked into place by attempting to move the seat forward or backward without using the lock release lever. Sudden or unexpected movement of the driver's seat could cause you to lose control of the vehicle resulting in an accident.

⚠ WARNING

- Do not adjust the seat whilst wearing seat belts. Moving the seat cushion forward may cause strong pressure on the abdomen.
 - Use extreme caution so that hands or other objects are not caught in the seat mechanisms whilst the seat is moving.
 - Do not put a cigarette lighter on the floor or seat. When you operate the seat, gas may gush out of the lighter and cause fire.
 - If there are occupants in the rear seats, be careful whilst adjusting the front seat position.
 - Use extreme caution when picking small objects trapped under the seats or between the seat and the centre console. Your hands might be cut or injured by the sharp edges of the seat mechanism.
-

Feature of Seat Leather (if equipped)

- Our car seats are upholstered with a combination of artificial and genuine leather. The genuine leather is made from the outer skin of an animal, which goes through a special process to be available for use. Since it is a natural substance, each part differs in thickness or density. Also, wrinkles could appear depending on the temperature and humidity.
- The seat cover is made of stretchable material to improve comfort of passengers.
- The parts contacting the body are curved and the side supporting area is high which provides driving comfort and stability.
- Wrinkles may appear naturally from usage. It is not a fault of the product.

⚠ CAUTION

- Wrinkles or abrasions which appear naturally from usage are not covered by warranty.
- Belts with metallic accessories, zippers or keys inside the back pocket may damage the seat fabric.
- Make sure not to wet the seat. It may change the nature of natural leather.

- Jeans or clothes which could bleach may contaminate the surface of the seat covering fabric.

Front seat adjustment for manual seat (if equipped)

The front seat can be adjusted by using the control levers located on the outside of the seat cushion.

Moving forward and backward

Adjust the seat before driving, and make sure the seat is locked securely by trying to move forward and backward without using the lever. If the seat moves, it is not locked properly.



To move the seat forward or backward:

1. Pull the seat slide adjustment lever up and hold it.
2. Slide the seat to the position you desire.
3. Release the lever and make sure the seat is locked in place.

Adjust the seat before driving, and make sure the seat is locked securely by trying to move forward and backward without using the lever. If the seat moves, it is not locked properly.

Reclining seatback



To recline the seatback:

1. Lean forward slightly and lift up the seatback recline lever.
2. Carefully lean back on the seat and adjust the seatback of the seat to the position you desire.
3. Release the lever and make sure the seatback is locked in place. (The lever **MUST** return to its original position for the seatback to lock.)

Changing seat cushion height (for driver's seat)



To change the height of the seat cushion, push the lever upwards or downwards.

- To lower the seat cushion, push down the lever several times.
- To raise the seat cushion, pull up the lever several times.

Front seat adjustment for power seat (if equipped)

The driver's seat can be adjusted by using the control switches located on the outside of the seat cushion. Before driving, adjust the seat to the proper position so as to easily control the steering wheel, pedals and switches on the instrument panel.

⚠ WARNING

The power seat is operable with the ignition OFF.

Therefore, children should never be left unattended in the car.

⚠ CAUTION

- The power seat is driven by an electric motor. Stop operating once the adjustment is completed. Excessive operation may damage the electrical equipment.
- When in operation, the power seat consumes a large amount of electrical power. To prevent unnecessary charging system drain, don't adjust the power seat longer than necessary whilst the engine is not running.
- Do not operate two or more power seat control switches at the same time. Doing so may result in power seat motor or electrical component malfunction.

Moving forward and backward



To move the seat forward or backward:

1. Push the control switch forward or rearward to move the seat to the desired position.
2. Release the switch once the seat reaches the desired position.

Reclining seatback



To recline the seatback:

1. Push the control switch forward or rearward to move the seatback to the desired angle.
2. Release the switch once the seat reaches the desired position.

Changing seat cushion tilt and height

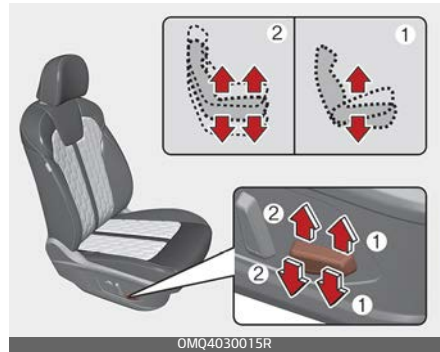

To change the height of the seat:

1. Pull the front portion of the control switch up to raise or press down to lower the front part of the seat cushion.
Pull the rear portion of the control switch up to raise or press down to lower the seat cushion.
2. Release the switch once the seat reaches the desired position.

Adjusting lumbar support (if equipped)

Type A



Type B



The lumbar support can be adjusted by pressing the lumbar support switch on the side of the seat.

1. Press the front portion of the switch to increase support, or the rear portion of the switch, to decrease support.
2. Release the switch once it reaches the desired position.

Adjusting cushion extension for driver's seat (if equipped)



1. Press the front portion of the switch to raise the cushion extension, or the rear portion of the switch to lower it.

2. Release the switch once the cushion extension reaches the desired position.

Front passenger seat control (if equipped)



The rear seat passenger may use the switches to control the front passenger seat.

Sliding forward or rearward:

- To move the front passenger seat forward, press the switch (1). To move the front passenger seat rearward, press the switch (2).

Angle adjustment:

- To recline the front passenger seat forward, press the switch (3). To recline the front passenger seat rearward, press the switch (4).

Headrest (for front seat)

The driver's and front passenger's seats are equipped with a headrest for the occupant's safety and comfort.



The headrest not only provides comfort for the driver and front passenger, but also helps protect the head and neck in the event of a collision.

⚠ WARNING

- For maximum effectiveness in case of an accident, the headrest should be adjusted so the middle of the headrest is at the same height of the centre of gravity of an occupant's head. Generally, the centre of gravity of most people's head is similar with the height of the top of their eyes. Also, adjust the headrest as close to your head as possible. For this reason, the use of a cushion that holds the body away from the seatback is not recommended.

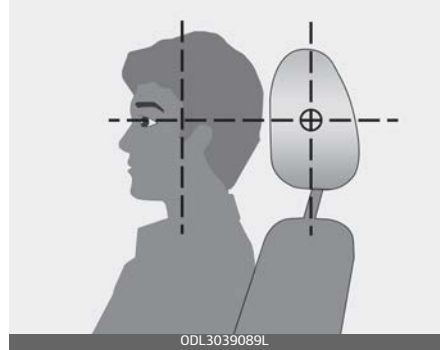

- Do not operate the vehicle with the headrests removed or reversed as severe injury to the occupants may occur in the event of an accident. Headrests may provide protection against neck injuries when properly adjusted.
- Do not adjust the headrest position of the driver's seat whilst the vehicle is in motion.

⚠ CAUTION

When there is no occupant in the rear seats, adjust the height of the headrest to the lowest position. The rear seat headrest can reduce the visibility of the rear area.

Forward and backward adjustment



The headrest may be adjusted forward to 3 different positions by pulling the headrest forward to the desired detent.

To adjust the headrest to it's furthest backwards position, pull it fully forward to the farthest position and release it.

Adjust the headrest so that it properly supports the head and neck.

Adjusting the height up and down



To raise the headrest:

1. Pull it up to the desired position (1).
2. To lower the headrest, push and hold the release button (2) on the headrest support.
3. Lower the headrest to the desired position (3).

⚠ WARNING

Make sure the headrest locks in position after adjusting it to properly protect the occupants.

⚠ CAUTION

If you recline the seatback towards the front with the headrest and seat cushion raised, the headrest may come in contact with the sun visor or other parts of the vehicle.



Removing headrest

Type A



Type B



To remove the headrest:

1. Recline the seatback (2) with the recline lever or switch (1).
2. Raise headrest as far as it can go.
3. Press the headrest release button (3) whilst pulling the headrest up (4).

⚠ WARNING

NEVER allow anyone to ride in a seat with the headrest removed.

Reinstalling headrest

Type A



Type B

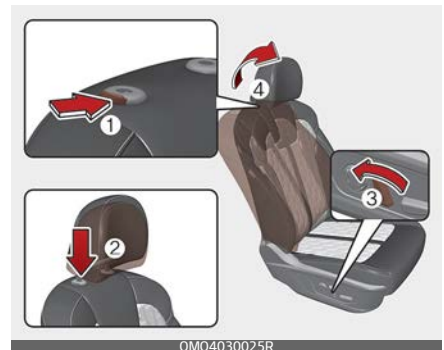

To reinstall the headrest:

1. Put the headrest poles (2) into the holes whilst pressing the release button (1).
2. Recline the seatback (4) with the recline lever or switch (3).
3. Adjust the headrest to the appropriate height.

⚠ WARNING

Always make sure the headrest locks into position after reinstalling and adjusting it properly.

Seatback pocket

There is a double pocket (1) in the front seat back for storing simple books or atlases, and USB charger (2) (if equipped) for rear passengers.

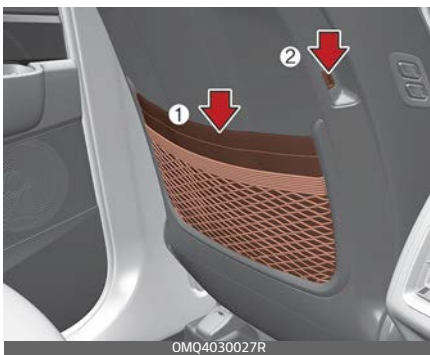

⚠ WARNING

Seatback pockets

Do not put heavy or sharp objects in the seatback pockets. In an accident they could come loose from the pocket and injure vehicle occupants.

Small pocket (2nd row seat, for 6 passenger vehicle)

There is a small pocket in the 2nd row seat cushion for storing simple objects.



Rear seat adjustment

Forward and backward (2nd row seat)

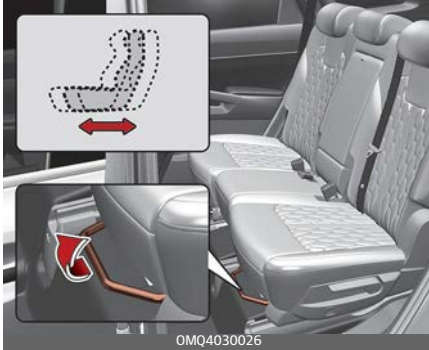

To move the seat forward or backward:

1. Pull the seat slide adjustment lever up and hold it.
2. Slide the seat to the position you desire.
3. Release the lever and make sure the seat is locked in place.

Adjust the seat before driving, and make sure the seat is locked securely by trying to move forward and backward without using the lever. If the seat moves, it is not locked properly.

Seatback angle (2nd row seat)

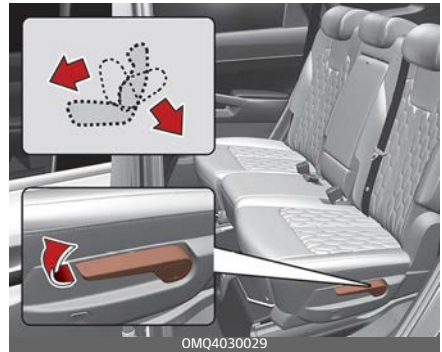

To recline the seatback:

1. Pull up the seatback recline lever.
2. Hold the lever and adjust the seatback of the seat to the position you desire.
3. Release the lever and make sure the seatback is locked in place. (The lever **MUST** return to its original position for the seatback to lock.)

Walk-in seat (2nd row seat, for 6/7 passenger vehicle)

To get in or out of the 3rd row seat:

1. Routing the seat belt webbing through the rear seat belt guide clip. After inserting the seat belt, tighten the belt webbing by pulling it up.

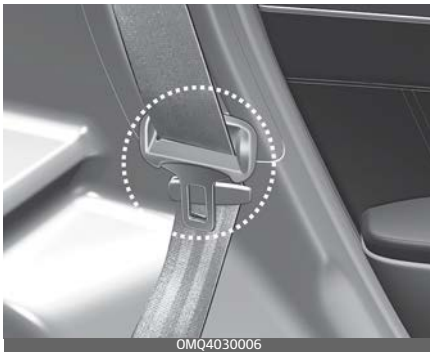

2. Press the switch (1) on the top of the 2nd row seat or press the switch (2) on the bottom of the 2nd row seat to unlock.

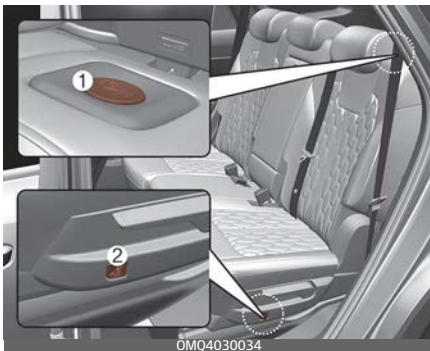

Or, the 2nd row seat can be unlocked by pulling the strap (if equipped) located beneath the 2nd row seat seatback. If the

strap is located beneath the 2nd row seatback, there is a label attached to show where the strap is located in.

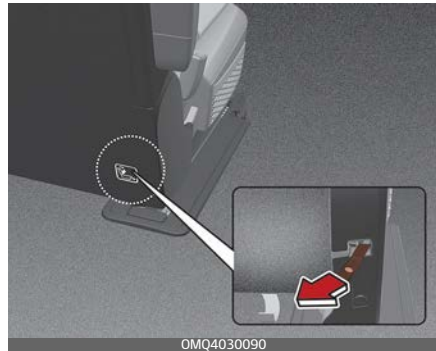

3. The 2nd row seatback will be folded and push the seat to the farthest forward position. After getting in or out, slide the 2nd row seat to the farthest rearward position and pull the seatback firmly backward until it clicks into place. Make sure that the seat is locked in place.



⚠️ WARNING

Never attempt to adjust whilst the vehicle is moving or the 2nd row seat is occupied as the seat may suddenly move and cause the passenger on the seat to be injured.

Folding the rear seat

The rear seatbacks can be folded to facilitate carrying long items or to increase the luggage capacity of the vehicle.

⚠️ WARNING

The purpose of the fold-down rear seatbacks is to allow you to carry longer objects that could not be accommodated in the cargo area. Never allow passengers to sit on top of the folded down seatback whilst the vehicle is moving. This is not a proper seating position and no seat belts are available for use. This could result in serious injury or death in case of an accident or sudden stop. Objects carried on the folded down seatback should not extend higher than the top of the front seatbacks. This could allow cargo to slide forward and cause injury or damage during sudden stops.

Folding down the rear seatback

1. Insert the rear seat belt buckle in the pocket between the rear seatback and cushion, and insert the rear seat belt webbing in the guide to prevent the seat belt from being damaged.

2nd row seat

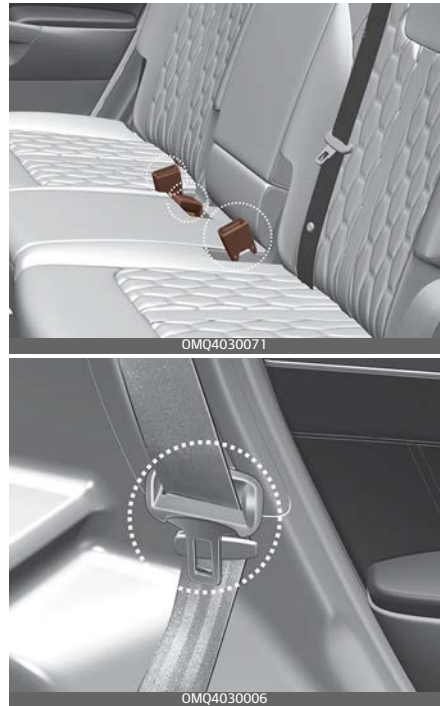

3rd row seat (if equipped)

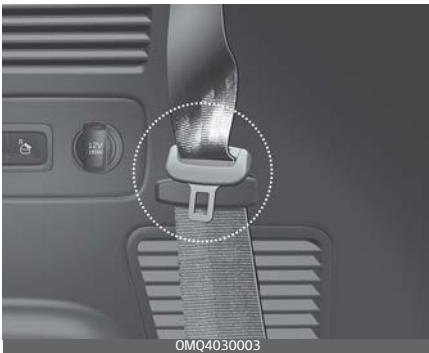
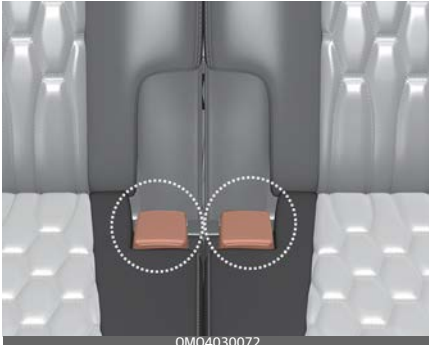

2nd row seat



3rd row seat (if equipped)



2. Set the front seatback to the upright position and if necessary, slide the front seat forward.
3. Lower the rear headrests to the lowest position.
4. Pull on the seatback folding lever (for 2nd row) or strap (for 3rd row), then fold the seat toward the front of the vehicle. When you return the seatback to its upright position, always be sure it has locked into position by pushing on the top of the seatback.

5. To use the rear seat, lift and pull the seatback backward by pulling on the folding lever (for 2nd row) or strap (for 3rd row). Pull the seatback firmly until it clicks into place. Make sure the seatback is locked in place.

2nd row seat



2nd row seat folding (from 3rd row) (if equipped)



3rd row seat (if equipped)

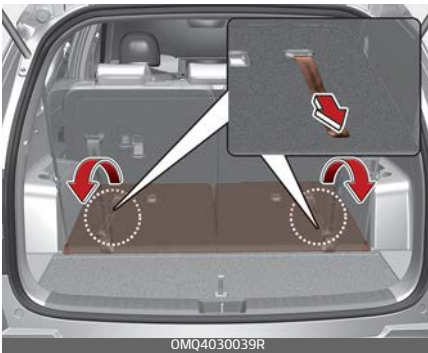

2nd row seat folding switch is located on the right side of the 3rd row seat.

The 2nd row seat back will be folded.

If you press the left switch, left side seat back and centre seat back will be folded.

If you press the right switch, right side seat back will be folded.

6. Return the rear seat belt to the proper position.

⚠ WARNING

Rear seat folding

Do not fold the rear seats (2nd & 3rd row seats), if passengers, pets or luggage are in the rear seats.

It may cause injury or damage to passengers, pets, luggage.

4

⚠ WARNING**Uprighting seat**

When you return the seatback to its upright position, hold the seatback and return it slowly. If the seatback is returned without holding it, the back of the seat could spring forward resulting in injury caused by being struck by the seatback.

⚠ CAUTION**Damaging rear seat belt buckles**

When you fold the rear (2nd and/or 3rd row) seatback, insert the buckle in the pocket between the rear seatback and cushion. Doing so can prevent the buckle from being damaged by the rear seatback.

⚠ CAUTION**Rear seat belts**

When returning the rear (2nd and/or 3rd row) seatbacks to the upright position, remember to return the rear shoulder belts to their proper position. Routing the seat belt webbing through the rear seat belt guides will help keep the belts from being trapped behind or under the seats.

⚠ WARNING**Cargo**

Cargo should always be secured to prevent it from being thrown about the vehicle in a collision and causing injury to the vehicle occupants. Do not place objects in the rear (2nd and/or 3rd row) seats, since they cannot be properly secured and may hit the front seat occupants in a collision.

⚠ WARNING**Cargo loading**

Make sure the engine is off, the automatic transmission is in P (Park) or the manual transmission is in R (Reverse) or 1st, and the parking brake is securely applied whenever loading or unloading cargo. Failure to take these steps may allow the vehicle to move if the shift dial SBW is inadvertently moved to another position.

Headrest (for rear seat)

The rear seat(s) is equipped with headrests in all the seating positions for the occupant's safety and comfort.



The headrest not only provides comfort for passengers, but also helps protect the head and neck in the event of a collision.

⚠ WARNING

- For maximum effectiveness in case of an accident, the headrest should be adjusted so the middle of the headrest is at the same height as the centre of gravity of an occupant's head. Generally, the centre of gravity of most people's head is similar with the height of the top of their eyes. Also, adjust the headrest as close to your head as possible. For this reason, the use of a cushion that holds the body away from the seatback is not recommended.

- Do not operate the vehicle with the headrests removed or reversed as severe injury to the occupants may occur in the event of an accident. Headrests may provide protection against neck injuries when properly adjusted.
- Do not adjust the headrest position of the driver's seat whilst the vehicle is in motion.

⚠ CAUTION

When there is no occupant in the rear seats, adjust the height of the headrest to the lowest position. The rear seat headrest can reduce the visibility of the rear area.

Adjusting the height up and down (2nd and 3rd row seat)

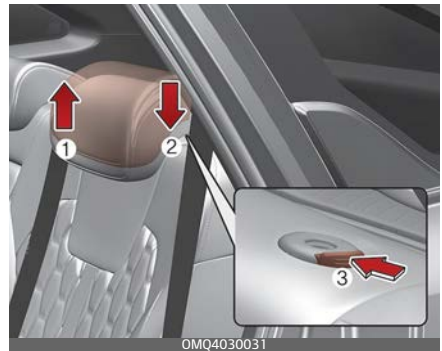

To raise the headrest, pull it up to the desired position (1). To lower the headrest, push and hold the release button (3) on the headrest

support and lower the headrest to the desired position (2).

Removal (2nd and 3rd row seat)

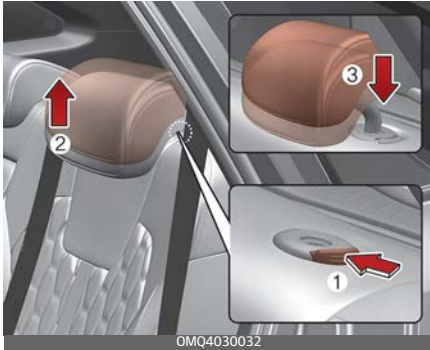

To remove the headrest, raise it as far as it can go then press the release button (1) whilst pulling the headrest up (2).

To reinstall the headrest, put the headrest poles (3) into the holes whilst pressing the release button (1). Then adjust it to the appropriate height.

⚠ WARNING

Make sure the headrest locks in position after adjusting it to properly protect the occupants.

Armrest



To use the armrest, pull it forward from the seatback.

Armrest adjustment (2nd row seat, for 6 passenger vehicle)



Adjustable armrest is located on each side of 2nd row seatback. To use the armrest, pull it forward from the seatback and adjust to desired angle. Pull it backward to relocate the armrest.

Seat belts

Seat belts are designed to bear upon the bony structure of the body, and should be worn low across the front of the pelvis, chest and shoulders.

Seat belt restraint system

WARNING

- For maximum restraint system protection, the seat belts must always be used whenever the car is moving.
- Seat belts are most effective when seatbacks are in the upright position.
- Children age 13 and younger must always be properly restrained in the rear seat. Never allow children to ride in the front passenger seat. If a child over 13 must be seated in the front seat, he/she must be properly belted and the seat should be moved as far back as possible.
- Never wear the shoulder belt under your arm or behind your back. An improperly positioned shoulder belt can cause serious injuries in a crash. The shoulder belt should be positioned midway over your shoulder across your collarbone.
- Never wear a seat belt over fragile objects. If there is a sudden stop or impact, the seat belt can damage it.

- Avoid wearing twisted seat belts. A twisted belt can't do its job as well. In a collision, it could even cut into you. Be sure the belt webbing is straight and not twisted.
- Be careful not to damage the belt webbing or hardware. If the belt webbing or hardware is damaged, replace it.

WARNING

Australian design rules

Seat belts are designed to bear upon the bony structure of the body, and should be worn low across the front of the pelvis or the pelvis, chest and shoulders, as applicable; wearing the lap section of the belt across the abdominal area must be avoided.

Seat belts should be adjusted as firmly as possible, consistent with comfort, to provide the protection for which they have been designed. A slack belt will greatly reduce the protection afforded to the wearer.

Care should be taken to avoid contamination of the webbing with polishes, oils and chemicals, and particularly battery acid.

Cleaning may safely be carried out using mild soap and water. The belt should be replaced if webbing becomes frayed, contaminated or damaged. It is essential to replace the entire assembly after it has been worn in a severe impact even if

damage to the assembly is not obvious. Belts should not be worn with straps twisted. Each belt assembly must only be used by one occupant; it is dangerous to put a belt around a child being carried on the occupant's lap.

⚠ WARNING

Australian design rules

- No modifications or additions should be made by the user which will either prevent the seat belt adjusting devices from operating to remove slack, or prevent the seat belt assembly from being adjusted to remove slack.
- When you fasten the seat belt, be careful not to latch the seat belt in buckles of other seat. It's very dangerous and you may not be protected by the seat belt properly.
- Do not unfasten the seat belt and do not fasten and unfasten the seat belt repeatedly whilst driving. This could result in loss of control, and an accident causing death, serious injury, or property damage.
- When fastening the seat belt, make sure that the seat belt does not pass over objects that are hard or can break easily.

- Make sure there is nothing in the buckle. The seat belt may not be fastened securely.

Seat belt warning



The seat belt warning light and warning chime operate under the following conditions.

Driver's seat belt

- Regardless of the driver's seat belt fastening, the warning light will illuminate for approximately 3 ~ 6 seconds each time you turn the ignition switch or ENGINE START/STOP button ON. If the driver's seat belt is not fastened, the warning chime will sound for about 6 seconds and the warning light will stay turned ON until the driver's seat belt is fastened.
- If you start to drive without the driver's seat belt fastened, when you drive under 20 km/h or stop, the warning light will illuminate. When you drive 20 km/h or faster, the warning light will blink and warning chime will sound for approximately 100 seconds.
- When the driver's seat belt is unfastened during driving, the warning light will illuminate when

the speed is under 20 km/h. When the speed is 20 km/h or faster, the warning light will blink and warning chime will sound for approximately 100 seconds.

Front passenger's seat belt

- Regardless of the passenger's seat belt fastening, the warning light will illuminate for approximately 3 ~ 6 seconds each time you turn the ignition switch ON. If the passenger's seat belt is not fastened, the warning light will stay turned ON until the passenger's seat belt is fastened.
- If you start to drive without the passenger's seat belt fastened, when you drive under 20 km/h or stop, the warning light will illuminate. When you drive 20 km/h or faster, the warning light will blink and warning chime will sound for approximately 100 seconds.
- When the passenger's seat belt is unfastened during driving, the warning light will illuminate when the speed is under 20 km/h. When the speed is 20 km/h or faster, the warning light will blink and warning chime will sound for approximately 100 seconds.

⚠ WARNING

Riding in an improper position adversely affects the front seat belt warning system. It is important for the driver to instruct the passenger to properly be seated as instructed in this manual.

*** NOTICE**

- You can find the front passenger's seat belt warning light on the instrument cluster.
- Although the front passenger seat is not occupied, the seat belt warning light will blink or illuminate for 6 seconds.
- The front passenger's seat belt warning may operate when luggage is placed.

Rear passenger's seat belt warning

2nd row seat



* (1) Left side, (2) Centre, (3) Right side

3rd row seat (if equipped)



* 2nd row seat: (1) Left side, (2) Centre, (3) Right side

* 3rd row seat: (4) Left side, (5) Right side

- As a reminder to the rear passenger, the rear passenger's seat belt warning lights will illuminate for approximately 6 seconds each time you turn the ignition switch ON regardless of belt fastening.
- If you start to drive without the seat belt fastened or unfasten the seat belt when you drive under 20 km/h, the corresponding warning light will continue to illuminate.
- If you start to drive without the seat belt fastened or unfasten the seat belt when you drive over 20 km/h, the seat belt warning chime will sound for approximately 35 seconds and the corresponding warning light will blink.

Seat belt - Driver's 3-point system with emergency locking retractor

Fastening the seat belt:

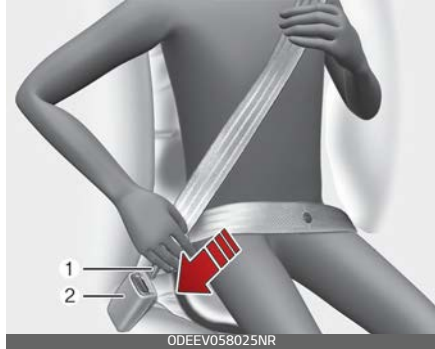

- To fasten your seat belt, pull it out of the retractor and insert the metal tab (1) into the buckle (2). There will be an audible "click" when the tab locks into the buckle.

The seat belt automatically adjusts to the proper length only after the lap belt portion is adjusted manually so that it fits snugly around your hips. If you lean forward in a slow, easy motion, the belt will extend and let you move around. If there is a sudden stop or impact, however, the belt will lock into position. It will also lock if you try to lean forward too quickly.

*** NOTICE**

If you are not able to pull out the seat belt from the retractor, firmly pull the belt out and release it. Then you will be able to pull the belt out smoothly.

⚠ WARNING

You should place the lap belt portion as low as possible and snugly across your hips, not on your waist. If the lap belt is located too high on your waist, it may increase the chance of injury in the event of a collision. Both arms should not be under or over the belt. Rather, one should be over and the other under, as shown in the illustration.

Never wear the seat belt under the arm near the door.

Releasing the seat belt:



- Press the release button (1) in the locking buckle.

When it is released, the belt should automatically draw back into the retractor.

If this does not happen, check the belt to be sure it is not twisted, then try again.

Adjusting the height of shoulder belt

You can adjust the height of the shoulder belt anchor to one of 4 positions for maximum comfort and safety.

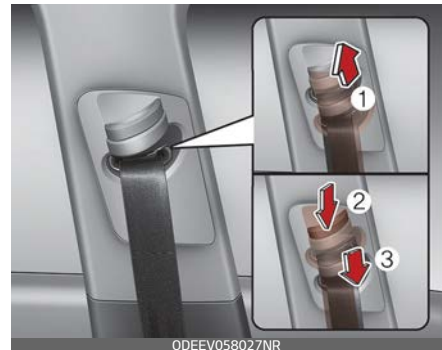

The height of the adjusting seat belt should not be too close to your neck. You will not be getting the most effective protection. The shoulder portion should be adjusted so that it lies across your chest and midway over your shoulder near the door and not your neck.

To adjust the height of the seat belt anchor, lower or raise the height adjuster into an appropriate position.

- To raise the height adjuster, pull it up (1).
- To lower it, push it down (3) whilst pressing the height adjuster button (2).

Release the button to lock the anchor into position. Try sliding the height adjuster to make sure that it has locked into position.

Improperly positioned seat belts can cause serious injuries in an accident.

⚠ WARNING

- Verify the shoulder belt anchor is locked into position at the appropriate height. Never position the shoulder belt across your neck or face.
- Failure to replace seat belts after an accident could leave you with damaged seat belts that will not provide protection in the event of another collision leading to personal injury or death. Replace your seat belts after being in an accident as soon as possible.

⚠ CAUTION

Do NOT fold down the left portion of the rear seatback when the rear centre seat belt is buckled. ALWAYS UNBUCKLE the rear centre seat belt before folding down the left portion of the rear seatback. If the rear centre seat belt is buckled when the left portion of the rear seatback is

folded down, distortion and damage to the top portion of the seatback and seat belt garnish may result, causing the seatback to lock into the folded down position.

The seat belt should be locked into the buckle on each seat cushion to be properly fastened.



1. Rear right seat belt fastening buckle
2. Rear centre seat belt fastening buckle
3. Rear left seat belt fastening buckle

⚠ WARNING

Prior to fastening the rear seat belts, ensure the latch matches the seat belt buckle. Forcefully fastening the left or right seat belt to the centre buckle can result in an improper fastening scenario that will not protect you in an accident.

When using the rear centre seat belt, the buckle with the "CENTER" mark must be used.

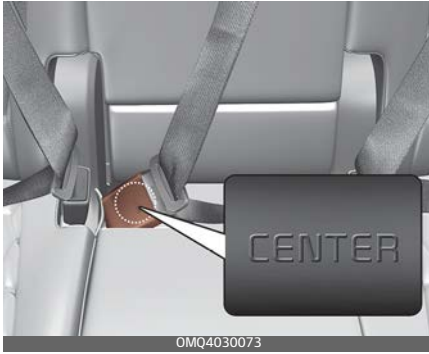

OMQ4030073

CAUTION

Do not force to lock the left or right seat belt into the centre seat belt buckle.

Make sure to lock the rear centre seat belt into the centre seat belt buckle.

If not, the improperly fastened seat belt will not be able to provide protection.

Stowing the rear seat belt

The rear seat belt buckles can be stowed in the pocket between the rear seatback and cushion when not in use.

2nd row seat



OMQ4030071

3rd row seat

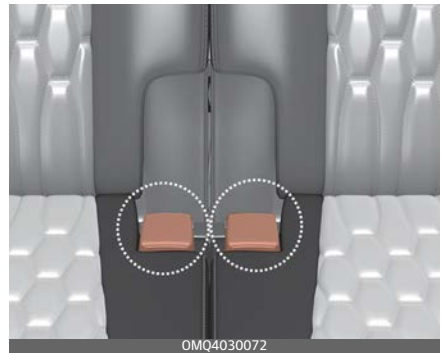

OMQ4030072

1. Route the seat belt webbing through the rear seat belt guides. It will help keep the belts from being trapped behind or under the seats.
2. After inserting the seat belt, tighten the belt webbing by pulling it up.

CAUTION

When pulling out to wear the seat belt, the tongue should be slowly pulled out of the seat belt guide so

that the seat belt guide does not come off the trim.

Releasing the seat belt:



- The seat belt is released by pressing the release button (1) on the locking buckle. When it is released, the belt should automatically draw back into the retractor. If this does not happen, check the belt to make sure it is not twisted, then try again.

Pre-tensioner seat belt



Your vehicle is equipped with driver's and front passenger's Pre-tensioner seat belts.

The purpose of the pre-tensioner is to make sure that the seat belts fit tightly against the occupant's body in certain collisions.

The pre-tensioner seat belts may be activated in crashes where the collision is severe enough.

When the vehicle stops suddenly, or if the occupant tries to lean forward too quickly, the seat belt retractor will lock into position. In certain frontal collisions, the pre-tensioner will activate and pull the seat belt into tighter contact against the occupant's body.

If the system senses excessive tension on the driver or passenger's seat belt when the pre-tensioner system activates, the load limiter inside the retractor pre-tensioner will release some of the pressure on the affected seat belt.

⚠ WARNING

For your safety, be sure that the belt webbing is not loose or twisted and always sit properly on your seat.

* NOTICE

The pre-tensioner will activate not only in a frontal collision but also in a side collision, if the vehicle is equipped with a side or curtain air bag.

The seat belt pre-tensioner system consists mainly of the following components. Their locations are shown in the illustration:

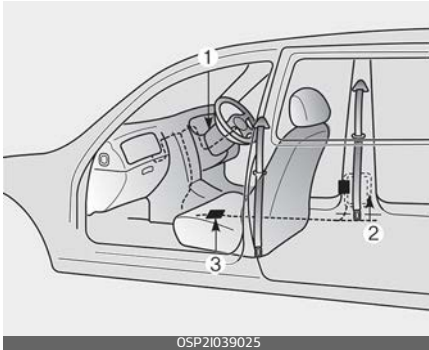

1. SRS air bag warning light
2. Front retractor pre-tensioner assembly
3. SRS control module

⚠ WARNING

To obtain maximum benefit from a pre-tensioner seat belt:

1. The seatbelt must be working correctly and adjusted to the proper position. Please read and follow all of the important information and precautions about your vehicle's occupant safety

features – including seat belts and air bags – that are provided in this manual.

2. Be sure you and your passengers always wear seat belts properly.

* NOTICE

- When the pre-tensioner seat belts are activated, a loud noise may be heard and fine dust, which may appear to be smoke, may be visible in the passenger compartment. These are normal operating conditions and are not hazardous.
- Although it is harmless, the fine dust may cause skin irritation and should not be breathed for prolonged periods. Wash all exposed skin areas thoroughly after an accident in which the pre-tensioner seat belts were activated.
- Because the sensor that activates the SRS air bag is connected with the pre-tensioner seat belt, the SRS air bag warning light on the instrument panel will illuminate for approximately 3 ~ 6 seconds after the ignition switch or ENGINE START/STOP button has been turned to the "ON" position, and then it should turn off.

⚠ CAUTION

If the pre-tensioner seat belt is not working properly, the SRS air bag warning light will illuminate even if there is no malfunction of the SRS air bag. If the SRS air bag warning light does not illuminate when the ignition key is turned to ON, or if it remains illuminated after illuminating for approximately 3 ~ 6 seconds, or if it illuminates whilst the vehicle is being driven, have the system inspected by a professional workshop. Kia recommends to visit an authorised Kia dealer/service partner.

⚠ WARNING

- Pre-tensioner seat belts systems are designed to operate only one time. After activation, pre-tensioner seat belts must be replaced. All seat belts, of any type, should always be replaced after they have been worn during a collision.
 - The pre-tensioner seat belt assembly mechanisms become hot during activation. Do not touch the pre-tensioner seat belt assemblies for several minutes after they have been activated.
 - Do not attempt to inspect or replace the pre-tensioner seat belts yourself. Have the system inspected by a professional workshop.
-
- Do not attempt to service or repair the pre-tensioner seat belt system in any manner.
 - Improper handling of the pre-tensioner seat belt assemblies, and failure to heed the warnings not to strike, modify, inspect, replace, service or repair the pre-tensioner seat belt assemblies may lead to improper operation or inadvertent activation and serious injury.
 - Always wear the seat belts when driving or riding in a motor vehicle.
 - If the vehicle or pre-tensioner seat belt must be discarded, contact a professional workshop. Kia recommends to visit an authorised Kia dealer/service partner.
 - Body work on the front area of the vehicle may damage the pre-tensioner seat belt system. Therefore, have the system serviced by a professional workshop. Kia recommends to visit an authorised Kia dealer/service partner.
-

Seat belt precautions

WARNING

All occupants of the vehicle must wear their seat belts at all times. Seat belts and child restraints reduce the risk of serious or fatal injuries for all occupants in the event of a collision or sudden stop. Without a seat belt, occupants could be shifted too close to a deploying air bag, strike the interior structure or be thrown from the vehicle. Properly worn seat belts greatly reduce these hazards.

Always follow the precautions about seat belts, air bags and occupant seat contained in this manual.

Infant or small child

You should be aware of the specific requirements in your country. Child and/or infant seats must be properly placed and installed in the rear seat.

For more information about the use of these restraints, refer to "Child restraint system (CRS)" on page 4-36.

WARNING

Every person in your vehicle needs to be properly restrained at all times, including infants and children. Never hold a child in your arms or

lap when riding in a vehicle. The violent forces created during a crash will tear the child from your arms and throw the child against the interior. Always use a child restraint appropriate for your child's height and weight.

* NOTICE

Small children are best protected from injury in an accident when properly restrained in the rear seat by a child restraint system that meets the requirements of the Safety Standards of your country. Before buying any child restraint system, make sure that it has a label certifying that it meets Safety Standards of your country. The restraint must be appropriate for your child's height and weight. Check the label on the child restraint for this information. Refer to "Child restraint system (CRS)" on page 4-36.

Larger children

Children who are too large for child restraint systems should always occupy the rear seat and use the available lap/shoulder belts. The lap portion should be fastened and snugged on the hips and as low as possible. Check if the belt fits periodically. A child's squirming could

put the belt out of position. Children are afforded the most safety in the event of an accident when they are restrained by a proper restraint system in the rear seat. If a larger child (over age 13) must be seated in the front seat, the child should be securely restrained by the available lap/shoulder belt and the seat should be placed in the rearmost position. Children age 13 and under should be restrained securely in the rear seat. NEVER place a child age 13 and under in the front seat. NEVER place a rear facing child seat in the front seat of a vehicle.

If the shoulder belt portion slightly touches the child's neck or face, try placing the child closer to the centre of the vehicle. If the shoulder belt still touches their face or neck they need to be returned to a child restraint system.

⚠ WARNING

Shoulder belts on small children

- Never allow a shoulder belt to be in contact with a child's neck or face whilst the vehicle is in motion.
- If seat belts are not properly worn and adjusted on children, there is a risk of death or serious injury.

Pregnant women

The use of a seat belt is recommended for pregnant women to lessen the chance of injury in an accident. When a seat belt is used, the lap belt portion should be placed as low and snugly as possible on the hips, not across the abdomen. For specific recommendations, consult a physician.

⚠ WARNING

Pregnant women

Pregnant women must never place the lap portion of the safety belt over the area of the abdomen where the fetus is located or above the abdomen where the belt could crush the fetus during an impact.

Injured person

A seat belt should be used when an injured person is being transported. When this is necessary, you should consult a physician for recommendations.

One person per belt

Two people (including children) should never attempt to use a single seat belt. This could increase the severity of injuries in case of an accident.

Do not lie down

To reduce the chance of injuries in the event of an accident and to achieve maximum effectiveness of the restraint system, all passengers should be sitting up and the front seats should be in an upright position when the car is moving. A seat belt cannot provide proper protection if the person is lying down in the rear seat or if the front seat is in a reclined position.

⚠ WARNING

Riding with a reclined seatback increases your chance of serious or fatal injuries in the event of a collision or sudden stop. The protection of your restraint system (seat belts and air bags) is greatly reduced by reclining your seat. Seat belts must be snug against your hips and chest to work properly. The more the seatback is reclined, the greater the chance that an occupant's hips will slide under the lap belt causing serious internal injuries or the occupant's neck could strike the shoulder belt. Drivers and passengers should always sit well back in their seats, properly belted, and with the seatbacks upright.

Care of seat belts

Seat belt systems should never be disassembled or modified. In addition, care should be taken to assure that seat belts and belt hardware are not damaged by seat hinges, doors or other abuse.

⚠ WARNING

- When you return the rear seatback to its upright position after the rear seatback was folded down, be careful not to damage the seat belt webbing or buckle. Be sure that the webbing or buckle does not get caught or pinched in the rear seat. A seat belt with damaged webbing or buckle will not be as strong and could possibly fail during a collision or sudden stop, resulting in serious injury. If the webbing or buckles are damaged, get them replaced immediately.
 - Seat belts can become hot in a vehicle that has been closed up in sunny weather. They could burn infants and children.
-

Periodic inspection

It is recommended that all seat belts be inspected periodically for wear or damage of any kind. Any damaged parts should be replaced as soon as possible.

Keep belts clean and dry

Seat belts should be kept clean and dry. If belts become dirty, they can be cleaned by using a mild soap solution and warm water. Bleach, dye, strong detergents or abrasives should not be used because they may damage and weaken the fabric.

When to replace seat belts

Entire in-use seat belt assembly or assemblies should be replaced if the vehicle has been involved in an accident. This should be done even if no damage is visible. In this case, have the system replaced by a professional workshop. Kia recommends to consult an authorised Kia dealer/service partner.

Child restraint system (CRS)

Our recommendation: Children always in the rear

⚠ WARNING

Always properly restrain children in the vehicle. Children of all ages are safer when riding in the rear seats. Never place a rearward-facing Child Restraint System on the front passenger seat, unless the air bag is deactivated.

Children under age 13 should always ride in the rear seats and must always be properly restrained to minimise the risk of injury in an accident, sudden stop or sudden manoeuvre.

According to accident statistics, children are safer when properly restrained in the rear seats than in the front seat. Children too large for a Child Restraint System must use the seat belts provided.

Most countries have regulations which require children to travel in approved Child Restraint Systems.

The laws governing the age or height/weight restrictions at which seat belts can be used instead of Child Restraint System differs among countries, so you should be aware of the specific requirements

in your country, and where you are travelling.

Child Restraint Systems must be properly installed in the vehicle seat. Always use a commercially available Child Restraint System that meets the requirements of your country.

Child Restraint System (CRS)

Infants and younger children must be restrained in an appropriate rearward-facing or forward-facing CRS that has first been properly secured to the seat of the vehicle. Read and comply with the instructions for installation and use provided by the manufacturer of the Child Restraint System.

⚠ WARNING

- Always follow the Child Restraint System manufacturer's instructions for installation and use.
- Always properly restrain your child in the Child Restraint System.
- Do not use an infant carrier or a child safety seat that "hooks" over a seatback, it may not provide adequate protection in an accident.
- After an accident, have the system checked by a professional workshop. Kia recommends to

visit an authorised Kia dealer/service partner.

Selecting a Child Restraint System (CRS)

When selecting a Child Restraint System for your child, always:

- Make sure the Child Restraint System has a label certifying that it meets the applicable Safety Standards of your country. A Child Restraint System may only be installed if it was approved in accordance with the requirements of ECE-R44 or ECE-R129 or relevant regulation.
- Select a Child Restraint System based on your child's height and weight. The required label or the instructions for use typically provide this information.
- Select a Child Restraint System that fits the vehicle seating position where it will be used. For the suitability of Child Restraint Systems on the vehicle's seating positions, please refer to "Suitability of each seating position for belted, i-Size & ISOFIX Child Restraint Systems (CRS) according to UN regulations (Information for use by vehicle users and CRS manufacturers)" on page 4-45.

- Read and comply with the warnings and instructions for installation and use provided with the Child Restraint System.

Child restraint system types

There are three main types of Child Restraint Systems:

- Rearward-facing CRS
- Forward-facing CRS
- Booster seat

They are classified according to the child's age, height and weight.

Rearward-facing Child Restraint System



A rearward-facing Child Restraint System provides restraint with the seating surface against the back of the child. The harness system holds the child in place, and in an accident, acts to keep the child positioned in the Child Restraint Systems and reduce the stress to the fragile neck and spinal cord.

All children under the age of one year must always ride in a rearward-facing Child Restraint System. There are different types of rearward-facing Child Restraint Systems: infant-only Child Restraint Systems can only be used rearward-facing. Convertible and 3-in-1 Child Restraint Systems typically have higher height and weight limits for the rearward-facing position, allowing you to keep your child rearward-facing for a longer period of time.

Keep using Child Restraint Systems in the rearward-facing position as long as children fit within the height and weight limits allowed by the Child Restraint System's manufacturer.

Forward-facing Child Restraint System



A forward-facing Child Restraint System provides restraint for the child's body with a harness. Keep

children in a forward-facing Child Restraint System with a harness until they reach the top height or weight limit allowed by your Child Restraint System's manufacturer.

Once your child outgrows the forward-facing Child Restraint System, your child is ready for a booster seat.

Booster seats

A booster seat is a Child Restraint System designed to improve the fit of the vehicle's seat belt system. A booster seat positions the seat belt so that it fits properly over the stronger parts of your child's body. Keep your children in booster seats until they are big enough to fit in a seat belt properly.

For a seat belt to fit properly, the lap belt must lie comfortable across the upper thighs, not the stomach. The shoulder belt should lie comfortable across the shoulder and chest and not across the neck or face. Children under age 13 must always be properly restrained to minimise the risk of injury in an accident, sudden stop or sudden manoeuvre.

Installing a Child Restraint System (CRS)

⚠ WARNING

Before installing your Child Restraint System always: Read and follow the instructions provided by the manufacturer of the Child Restraint System. Failure to follow all warnings and instructions could increase the risk of the **SERIOUS INJURY** or **DEATH** if an accident occurs.

⚠ WARNING

If the vehicle's headrest prevents proper installation of a Child Restraint System, the headrest of the respective seating position shall be readjusted or entirely removed.

After selecting a proper Child Restraint System for your child and checking that the Child Restraint System fits properly on the seating position, there are three general steps for a proper installation:

- **Properly secure the Child Restraint System to the vehicle.** All Child Restraint Systems must be secured to the vehicle with the lap belt or lap part of a lap/shoulder belt or with the ISOFIX top-tether and/or ISOFIX anchorage and/or with the support leg.

- **Make sure the Child Restraint System is firmly secured.** After installing a Child Restraint System to the vehicle, push and pull the seat forward and from side-to-side to verify that it is securely attached to the seat. A Child Restraint System secured with a seat belt should be installed as firmly as possible. However, some side-to-side movement can be expected. When installing a Child Restraint System, adjust the vehicle seat and seatback (up and down, forward and rearward) so that your child fits in the Child Restraint System in a comfortable manner.
- **Secure the child in the Child Restraint System.** Make sure the child is properly strapped in the Child Restraint System according to the Child Restraint System manufacturer's instructions.

⚠ CAUTION

A Child Restraint System in a closed vehicle can become very hot. To prevent burns, check the seating surface and buckles before placing your child in the Child Restraint System.

ISOFIX anchorage and top-tether anchorage (ISOFIX anchorage system) for children

The ISOFIX system holds a Child Restraint System during driving and in an accident. This system is designed to make installation of the Child Restraint System easier and reduce the possibility of improperly installing your Child Restraint System. The ISOFIX system uses anchors in the vehicle and attachments on the Child Restraint System. The ISOFIX system eliminates the need to use seat belts to secure the Child Restraint System to the rear seats.

ISOFIX anchorages are metal bars built into the vehicle. There are two lower anchors for each ISOFIX seating position that will accommodate a Child Restraint System with lower attachments.

To use the ISOFIX system in your vehicle, you must have a Child Restraint System with ISOFIX attachments.

The Child Restraint System manufacturer will provide you with instructions on how to use the Child Restraint System with its attachments for the ISOFIX anchorages.

ISOFIX anchorages have been provided in the left and right outboard

rear seating positions. Their locations are shown in the illustration.



⚠ WARNING

Do not attempt to install a Child Restraint System using ISOFIX anchorages in the rear centre seating position. There are no ISOFIX anchorages provided for this seat. Using the outboard seat anchorages, for the CRS installation on the rear centre seating position, can damage the anchorages.



- 1. ISOFIX Anchor Position Indicator
- 2. ISOFIX Anchor

ISOFIX anchorages are located between the seatback and the seat cushion of the rear seat left and right outboard seating positions, indicated by the symbols.

Securing a Child Restraint System with the "ISOFIX Anchorage System"

To install a ISOFIX-compatible Child Restraint System in either of the rear outboard seating positions:

1. Move the seat belt buckle away from the ISOFIX anchorages.
2. Move any other objects away from the anchorages that could prevent a secure connection between the Child Restraint System and the ISOFIX anchorages.
3. Place the Child Restraint System on the vehicle seat, then attach the seat to the ISOFIX anchorages according to the instructions provided by the Child Restraint System manufacturer.
4. Follow the instructions of the Child Restraint System's manufacturer for proper installation and connection of the ISOFIX attachments on the Child Restraint System to the ISOFIX anchorages.

⚠ WARNING

Take the following precautions when using the ISOFIX system:

- Read and follow all installation instructions provided with your Child Restraint System.
- To prevent the child from reaching and taking hold of unretracted seat belts, buckle all unused rear seat belts and retract the seat belt webbing behind the child. Children can be strangled if a shoulder belt becomes wrapped around their neck and the seat belt tightens.
- NEVER attach more than one Child Restraint System to a single anchorage. This could cause the anchor or attachment to come loose or break.
- Always have the ISOFIX (i- Size) system inspected by your dealer after an accident. An accident can damage the ISOFIX system and may not properly secure the Child Restraint System.

Securing a Child Restraint System seat with "Top-tether Anchorage" system

Type A



Type B



Child Restraint hook holders are located on the seat back.



1. Route the Child Restraint System seat strap over the seatback. For vehicles with adjustable headrest, route the tether strap under the headrest and between the headrest posts, otherwise route the tether strap over the top of the seatback.
2. Connect the top-tether to the top-tether anchorage, then tighten the top-tether according to the instructions of your Child Restraint System's manufacturer to firmly attach the Child Restraint System to the seat.

⚠ WARNING

Take the following precautions when installing the top-tether:

- Read and follow all installation instructions provided with your Child Restraint System.
- NEVER attach more than one Child Restraint System to a single ISOFIX top-tether anchorage. This could cause the anchorage or

attachment to come loose or break.

- Do not attach the top-tether to anything other than the correct top-tether anchorage. It may not work properly if attached to something else.
- Child Restraint System anchorages are designed to withstand only those loads imposed by correctly fitted Child Restraint System.

Under no circumstances are they to be used for adult seat belts or harnesses or for attaching other items or equipment to the vehicle.

Securing a Child Restraint System with a lap/shoulder belt

When not using the ISOFIX system, all Child Restraint Systems must be secured to a rear seat with the lap part of a lap/shoulder belt.



To install a Child Restraint System on the rear seats, do the following:

1. Place the Child Restraint System on a rear seat and route the lap/shoulder belt around or through the Child Restraint System, following the Child Restraint System manufacturer's instructions. Make sure the seat belt webbing is not twisted.
2. Fasten the lap/shoulder belt latch into the buckle. Listen for the distinct "click" sound. Position the release button so that it is easy to access in case of an emergency.



3. Remove as much slack from the belt as possible by pushing down on the Child Restraint System whilst feeding the shoulder belt back into the retractor.

4. Push and pull on the Child Restraint System to confirm that the seat belt is holding it firmly in place.



If your Child Restraint System manufacturer recommends the use of a top-tether with the lap/shoulder belt, see Securing a Child Restraint System seat with "Top-tether Anchorage" system section in this chapter.

To remove the Child Restraint System, press the release button on the buckle and then pull the lap/shoulder belt out of the Child Restraint System and allow the seat belt to retract fully.

Suitability of each seating position for belted, i-Size & ISOFIX Child Restraint Systems (CRS) according to UN regulations (Information for use by vehicle users and CRS manufacturers)

- Yes : Suitable for fitment of the designated category of CRS
- No : Not suitable for fitment of the designated category of CRS
- "-": Not applicable
- The table is based on LHD vehicle. Except for the front passenger seat, the table is valid for RHD vehicle. For RHD vehicle front passenger seat, please use information for the seating position number 3.

F: Forward facing

R: Rearward facing

CRS categories		Seating positions									
		1	2	3		4	5	6	7	8	9
				AirbagON	AirbagOff						
Universal belted CRS	All mass groups	-	-	No	Yes* ¹ (F, R)	Yes (F, R)	Yes (F, R)	Yes (F, R)	Yes* ^{2,3} (F, R)	-	Yes* ^{2,3} (F, R)
i-size CRS	ISOFIX CRF: F2, F2X, R1, R2	-	-	No	No	Yes (F, R)	No	Yes (F, R)	No	-	No
Carry-cot (ISOFIX lateral facing CRS)	ISOFIX CRF: L1, L2	-	-	No	No	No	No	No	No	-	No
ISOFIX infant* CRS (*: ISOFIX baby CRS)	ISOFIX CRF: R1	-	-	No	No	Yes (R)	No	Yes (R)	Yes* ² (R)	-	Yes* ² (R)
ISOFIX toddler CRS – small	ISOFIX CRF: F2,F2X, R2,R2X	-	-	No	No	Yes (F, R)	No	Yes (F, R)	Yes* ⁴ (F, R)	-	Yes* ⁴ (F, R)
ISOFIX toddler CRS – large* (*: not booster seats)	ISOFIX CRF: F3,R3	-	-	No	No	Yes (F, R)	No	Yes (F, R)	Yes (F)	-	Yes (F)
Booster Seat – reduced Width	ISO CRF: B2	-	-	No	No	Yes	No	Yes	Yes	-	Yes
Booster Seat – full Width	ISO CRF: B3	-	-	No	No	Yes	No	Yes	Yes	-	Yes

*1. To install Universal CRS, 1st row passenger seat back should be at its most upright position

*2. Never install CRS with a support leg on 3rd row seat

*3. To install CRS, 2nd row seat track should be at foremost position

*4. R2X is not allowed in 3rd row

Seat Number	Position in the vehicle	Seating positions
1	Front left	
2	Front centre	
3	Front right	
4	2 nd row left	
5	2 nd row centre	
6	2 nd row right	
7	3 rd row left	
8	3 rd row centre	
9	3 rd row right	

- * If the vehicle headrest prevents proper installation of a CRS, the headrest of the seating position shall be readjusted or entirely removed
- * Never place a rearward facing Child Restraint System on the front passenger seat, unless the air bag is deactivated
- * 3rd row seats are available if your vehicle is a 6-seater or 7-seater
- * When installing Child Restraint System on 2nd row seats, move the seat to most rearward position

Recommended CRS for Vehicle according to UN regulations

Mass Group	Name	Manufacturer	Type of Fixation	ECE Approval No.
Group 0-1	BABY-SAFE 2 i-SIZE and BABY-SAFE i-SIZE BASE	Britax Romer	ISOFIX with support leg, rearward facing	R129 - E1 - 000008
Group 1	Duo Plus	Britax Romer	ISOFIX and top-tether	R44 - E1 - 04301133
Group 2	KidFix2 R	Britax Romer	ISOFIX and vehicle belt, using CRS lap belt guide	E1 - 04301304
Group 3	Dream	Nania/OSANN	Vehicle belt	E2 - 0403011

CRS Manufacturer information

Britax Römer: www.britax.com

Osann: www.osann.de

Air bag – supplemental restraint system

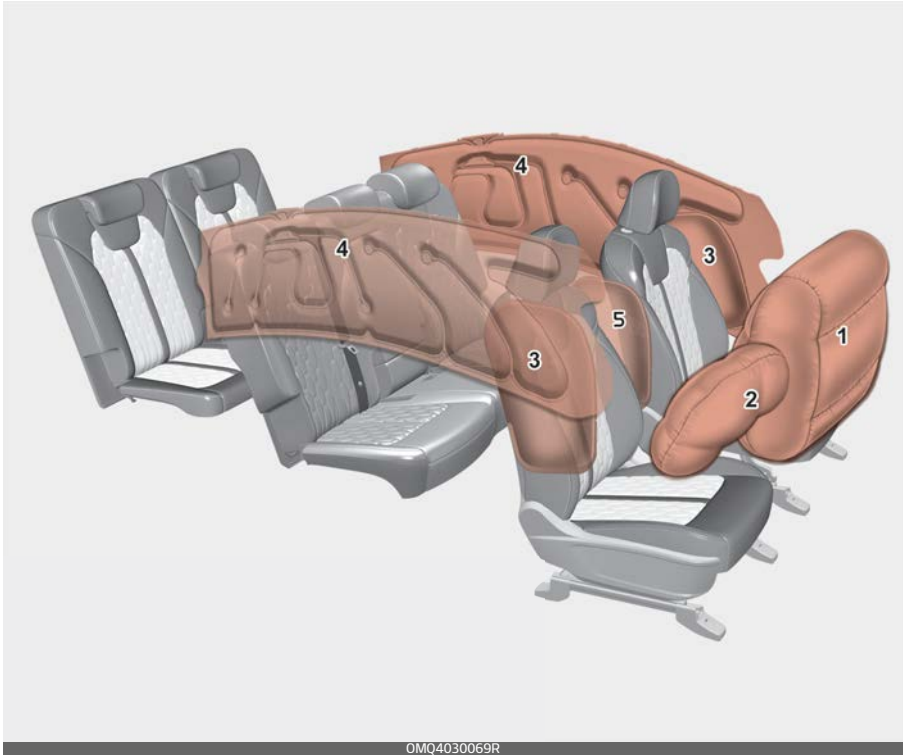

* The actual air bags in the vehicle may differ from the illustration.



1. Passenger's front air bag
2. Driver's front air bag
3. Side air bag*
4. Curtain air bag*
5. Driver's centre air bag
6. Front passenger's air bag ON/OFF switch*

* : if equipped

⚠ WARNING

- Even in vehicles with air bags, you and your passengers must always wear the safety belts provided in order to minimise the risk and severity of injury in the event of a collision or in most rollover situations.
- SRS and pre-tensioners contain explosive chemicals.

If scraping a vehicle without removing SRS and pre-tensioners from a vehicle, it may cause fire. Before scraping a vehicle, contact a professional workshop. Kia recommends to visit an authorised Kia dealer/service partner.

- Keep the SRS parts and wirings away from water or any liquid. If the SRS components are inoperative due to exposure to water or liquids, it may cause fire or severe injury.

How does the air bag system operate

- Air bags are activated (able to inflate if necessary) only when the ignition switch or ENGINE START/STOP button is in the ON position and it can be activated within about 3 minutes after ignition off.
- Air bags inflate instantly in the event of serious frontal or side collision (if equipped with side air

bag or curtain air bag) in order to help protect the occupants from serious physical injury.

*** NOTICE****Rollover sensor**

Also, the air bags inflate instantly in the event of a rollover in order to help protect the occupants from serious physical injury.

- There is no single speed at which the air bags will inflate. Generally, air bags are designed to inflate based upon the severity of a collision and its direction. These two factors determine whether the sensors produce an electronic deployment/ inflation signal.
- Air bag deployment depends on a number of factors including vehicle speed, angles of impact and the density and stiffness of the vehicles or objects which your vehicle hits in the collision. The determining factors are not limited to those mentioned above.
- The front air bags will completely inflate and deflate in an instant. It is virtually impossible for you to see the air bags inflate during an accident. It is much more likely that you will simply see the deflated air bags hanging out of their storage compartments after the collision.

- In order to help provide protection in a severe collision, the air bags must inflate rapidly. The speed of air bag inflation is a consequence of extremely short time in which a collision occurs and the need to get the air bag between the occupant and the vehicle structures before the occupant impacts those structures. This speed of inflation reduces the risk of serious or life-threatening injuries in a severe collision and is thus a necessary part of air bag design.
- However, air bag inflation can also cause injuries which can include facial abrasions, bruises and broken bones because the inflation speed also causes the air bags to expand with a great deal of force.
- **There are even circumstances under which contact with the steering wheel air bag can cause fatal injuries, especially if the occupant is positioned excessively close to the steering wheel.**

WARNING

- To avoid severe personal injury or death caused by deploying air bags in a collision, the driver should sit as far back from the steering wheel air bag. The front passenger should always move their seat as far back as possible and sit back in their seat.

- Air bag inflates instantly in an event of a collision, passengers may be injured by the air bag expansion force if they are not in a proper position.
- Air bag inflation may cause injuries including facial or bodily abrasions, injuries from broken glasses or burns.

Noise and smoke

When the air bags inflate, they make a loud noise and they leave smoke and powder in the air inside of the vehicle. This is normal and is a result of the ignition of the air bag inflator. After the air bag inflates, you may feel substantial discomfort in breathing due to the contact of your chest with both the seat belt and the air bag, as well as from breathing the smoke and powder.

Open your doors and/or windows as soon as possible after impact in order to reduce discomfort and prevent prolonged exposure to the smoke and powder.

Though smoke and powder are non-toxic, it may cause irritation to the skin (eyes, nose and throat, etc.). If this is the case, wash and rinse with cold water immediately and consult the doctor if the symptom persists.

⚠ WARNING

- When the air bags deploy, the air bag related parts in the steering wheel and/or instrument panel and/or in both sides of the roof rails above the front and rear doors are very hot. To prevent injury, do not touch the air bag storage areas internal components immediately after an air bag has inflated.
- Do not install or place any accessories near air bag deployment areas, such as the instrument panel, windows, pillars, and roof rails.

Front passenger's air bag warning label for child restraint system

Type A



Type B

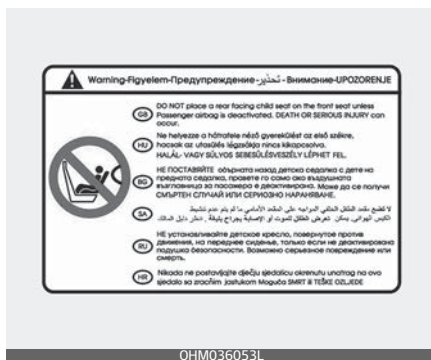

⚠ WARNING

- Never place a rear facing child restraint in the front passenger seat, unless the passenger-side air bag is deactivated. An inflating passenger-side air bag could impact the rear-facing child restraint and kill the child.
- Extreme Hazard! Do not use a rearward facing child restraint on a seat protected by an air bag in front of it!
- Never put a child restraint in the front passenger's seat. If the front passenger air bag inflates, it can cause serious or fatal injuries.

In addition, we recommend that you do not place front-facing child restraints in the front passenger's seat either. If the front passenger air bag inflates, it could cause serious or fatal injuries to the child.

If your vehicle is equipped with the passenger's front air bag ON/OFF switch, you can activate or deactivate the front passenger's air bag when necessary.

For more details, please refer to "Child restraint system (CRS)" on page 4–36. (if equipped)

▲ WARNING

- NEVER use a rearward facing child restraint on a seat protected by an ACTIVE AIR BAG in front of it, DEATH or SERIOUS INJURY to the CHILD can occur.
- When children are seated in the rear outboard seats of a vehicle equipped with side and/or curtain air bags, be sure to install the child restraint system as far away from the door side as possible, and securely lock the child restraint system in position. Inflation of side and/or curtain air bags could cause serious injury or death to an infant or child.

Air bag warning and indicator

Air bag warning light

The purpose of the air bag warning light in your instrument panel is to alert you of a potential problem with your air bag – Supplemental Restraint System (SRS).



0DEEV068100NR

When the ignition switch or ENGINE START/STOP button is turned ON, the warning light should illuminate for approximately 3 ~ 6 seconds, then go off.

Have the system checked if:

- The light does not turn on briefly when you turn the ignition ON.
- The light stays on after illuminating for approximately 3 ~ 6 seconds.
- The light comes on whilst the vehicle is in motion.
- The light blinks when the ignition switch or ENGINE START/STOP button is in ON position.

4

Passenger's front air bag ON indicator (if equipped)



OMQ4030086L



The passenger's front air bag ON indicator generally illuminates for approxi-

mately 4 seconds after the ignition switch or ENGINE START/STOP button is turned to the ON position. But, if the ignition switch or ENGINE START/STOP button is turned to the ON position within 3 minutes after ignition OFF, the indicator does not illuminate.

The passenger's front air bag ON indicator also comes on when the passenger's front air bag ON/OFF switch is set to the ON position.

Passenger's front air bag OFF indicator (if equipped)



 The passenger's front air bag OFF indicator illuminates for about 4 seconds after the ignition switch or ENGINE START/STOP button is turned to the ON position. But, if the ignition switch or ENGINE START/STOP button is turned to the ON position within 3 minutes after ignition OFF, the indicator does not illuminate.

The passenger's front air bag OFF indicator also comes on when the passenger's front air bag ON/OFF switch is set to the OFF position and goes off when the passenger's front air bag ON/OFF switch is set to the ON position.

CAUTION

If the passenger's front air bag ON/OFF switch malfunctions, the passenger's front air bag OFF indicator will not illuminate (The passenger's front air bag ON indicator comes on) and the passenger's front air bag will inflate in a frontal impact even if the passenger's front air bag ON/OFF switch is set to the OFF position.

In this case, have the passenger's front air bag ON/OFF switch and the SRS air bag system inspected by a professional workshop.

Kia recommends to visit an authorised Kia dealer/service partner.

SRS components and functions

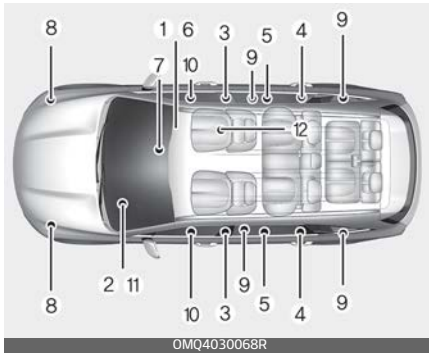

* The actual position of SRS components may differ from the illustration.

The SRS consists of the following components:

1. Driver's front air bag module
2. Passenger's front air bag module
3. Side air bag modules
4. Curtain air bag modules
5. Retractor pre-tensioner assemblies
6. Air bag warning light
7. SRS control module (SRSCM)/roll-over sensor
8. Front impact sensors
9. Side impact sensors
10. Side pressure sensors
11. Passenger's front air bag ON/OFF switch
12. Driver's centre air bag module

The SRSCM continually monitors all elements whilst the ignition switch or ENGINE START/STOP button is ON to determine if a frontal, near-frontal impact or side impact is

severe enough to require air bag deployment or pre-tensioner seat belt deployment.

The SRS air bag warning light on the instrument panel will illuminate for about 6 seconds after the ignition switch or ENGINE START/STOP button is turned to the ON position, after which the air bag warning light should go out.

⚠ WARNING

If any of the following conditions occurs, this indicates a malfunction of the SRS. In this case, have the system inspected by a professional workshop. Kia recommends to visit an authorised Kia dealer/service partner.

- The light does not turn on briefly when you turn the ignition ON.
- The light stays on after illuminating for approximately 6 seconds.
- The light comes on whilst the vehicle is in motion.
- The light blinks when the ignition switch or ENGINE START/STOP button is in ON position.

Driver's front air bag (1)



ODEEV058048NR

The air bag modules are located both in the centre of the steering wheel and in the front passenger's panel above the glove box. When the SRSCM detects a sufficiently severe impact to the front of the vehicle, it will automatically deploy the front air bags.

Driver's front air bag (2)



ODEEV058049NR

Upon deployment, tear seams molded directly into the pad covers will separate under pressure from the expansion of the air bags. Further opening of the covers then allows full inflation of the air bags.

Driver's front air bag (3)



ODEEV058050NR

A fully inflated air bag, in combination with a properly worn seat belt, slows the driver's or the passenger's forward motion, reducing the risk of head and chest injury.

After complete inflation, the air bag immediately starts deflating, enabling the driver to maintain forward visibility and the ability to steer or operate other controls.

Passenger's front air bag



ODEEV058051NR

⚠ WARNING

- Do not install or place any accessories (drink holder, CD holder, sticker, etc.) on the front passenger's panel above the glove box in a vehicle with a passenger's air bag. Such objects may become dangerous projectiles and cause injury if the passenger's air bag inflates.
- When installing a container of liquid air freshener inside the vehicle, do not place it near the instrument cluster nor on the instrument panel surface. It may become dangerous projectiles and cause injury if the passenger's air bag inflates.

⚠ WARNING

- If an air bag deploys, there may be a loud noise followed by a fine dust released in the vehicle. These conditions are normal and are not hazardous – the air bags are packed in this fine powder. The dust generated during air bag deployment may cause skin or eye irritation as well as aggravate asthma for some persons. Always wash all exposed skin areas thoroughly with cold water and a mild soap after an accident in which the air bags were deployed.
- The SRS can function only when the ignition key is in the ON posi-

tion. If the SRS air bag warning light does not illuminate, or continuously remains on after illuminating for about 6 seconds when the ignition key is turned to the ON position, or after the engine is started, comes on whilst driving, the SRS is not working properly. In this case, have the system inspected by a professional workshop. Kia recommends to visit an authorised Kia dealer/service partner.

- Before you replace a fuse or disconnect a battery terminal, turn the ignition switch or ENGINE START/STOP button to the LOCK position and remove the ignition key or turn off the ENGINE START/STOP button. Never remove or replace the air bag related fuse(s) when the ignition switch or ENGINE START/STOP button is in the ON position. Failure to heed this warning will cause the SRS air bag warning light to illuminate.

Driver's and passenger's front air bag

Driver's front air bag



Passenger's front air bag



Your vehicle is equipped with a Supplemental Restraint (Air Bag) System and lap/shoulder belts at both the driver and passenger seating positions.

The indications of the system's presence are the letters "AIR BAG" intagliated on the air bag pad cover in the steering wheel and the passenger's side front panel pad above the glove box.

The SRS consists of air bags installed under the pad covers in the centre of the steering wheel and the passenger's side front panel above the glove box.

The purpose of the SRS is to provide the vehicle's driver and/or the front passenger with additional protection than that offered by the seat belt system alone in case of a frontal impact of sufficient severity.

⚠ WARNING

The driver's hands should be placed on the steering wheel at the 9:00 and 3:00 positions. The passenger's arms and hands should be placed on their laps.

⚠ WARNING

Always use seat belts and child restraints – every trip, every time, everyone! Air bags inflate with considerable force and in the blink of an eye. Seat belts help keep occupants in proper position to obtain maximum benefit from the air bag. Even with air bags, improperly and unbelted occupants can be severely injured when the air bag inflates. Always follow the precautions about seat belts, air bags and occupant safety contained in this manual. To reduce the chance of serious or fatal injuries and receive the maxi-

maximum safety benefit from your restraint system:

- Never place a child in any child or booster seat in the front seat.
- ABC – Always Buckle Children in the back seat. It is the safest place for children of any age to ride.
- Front and side air bags can injure occupants improperly positioned in the front seats.
- Move your seat as far back as practical from the front air bags, whilst still maintaining control of the vehicle.
- You and your passengers should never sit or lean unnecessarily close to the air bags. Improperly positioned drivers and passengers can be severely injured by inflating air bags.
- Never lean against the door or centre console – always sit in an upright position.
- No objects should be placed over or near the air bag modules on the steering wheel, instrument panel, and the front passenger's panel above the glove box, because any such object could cause harm if the vehicle is in a crash severe enough to cause the air bags to deploy.
- Do not tamper with or disconnect SRS wiring or other components of the SRS system. Doing so could result in injury, due to accidental deployment of the air bags or by rendering the SRS inoperative.
- If the SRS air bag warning light remains illuminated whilst the vehicle is being driven, have the system inspected by a professional workshop. Kia recommends to visit an authorised Kia dealer/service partner.
- Air bags can only be used once – have the system replaced by a professional workshop. Kia recommends to visit an authorised Kia dealer/service partner.
- The SRS is designed to deploy the front air bags only when an impact is sufficiently severe and when the impact angle is less than 30° from the forward longitudinal axis of the vehicle. Additionally, the air bags will only deploy once. Seat belts must be worn at all times.
- Front air bags are not intended to deploy in side-impact, rear-impact or rollover crashes. In addition, front air bags will not deploy in frontal crashes below the deployment threshold.
- A child restraint system must never be placed in the front seat. The infant or child could be severely injured or killed by an air bag deployment in case of an accident.
- Children age 13 and under must always be properly restrained in

the rear seat. Never allow children to ride in the front passenger seat. If a child over age 13 must be seated in the front seat, he or she must be properly belted and the seat should be moved as far back as possible.

- For maximum safety protection in all types of crashes, all occupants including the driver should always wear their seat belts whether or not an air bag is also provided at their seating position to minimise the risk of severe injury or death in the event of a crash. Do not sit or lean unnecessarily close to the air bag whilst the vehicle is in motion.
- Sitting improperly or out of position can result in serious or fatal injury in a crash. All occupants should sit upright with the seat back in an upright position, centre on the seat cushion with their seat belt on, legs comfortably extended and their feet on the floor until the vehicle is parked and the ignition key is removed.
- The SRS air bag system must deploy very rapidly to provide protection in a crash. If an occupant is out of position because of not wearing a seat belt, the air bag may forcefully contact the occupant causing serious or fatal injuries.

⚠ WARNING

No attaching objects

No objects (such as crash pad cover, mobile phone holder, cup holder, perfume or stickers) should be placed over or near the air bag modules on the steering wheel, instrument panel, windscreen glass, and the front passenger's panel above the glove box. Such objects could cause harm if the vehicle is in a crash severe enough to cause the air bags to deploy. Do not place any objects over the air bag or between the air bag and yourself.

Passenger's front air bag ON/OFF switch (if equipped)



The passenger's front air bag can be deactivated by the passenger's front air bag ON/OFF switch if a child restraint is installed on the front passenger's seat or if the front passenger's seat is unoccupied by a person.

To ensure the safety of your child, the passenger's front air bag must be deactivated when it should be necessary to install a rearward facing child seat on the front passenger seat in exceptional circumstances.

To deactivate or reactivate the passenger's front air bag (if equipped)



- To deactivate the passenger's front air bag, insert the master key into the passenger's front air bag ON/OFF switch and turn it to the OFF position.

The passenger's front air bag OFF indicator (🚫👤) will illuminate and stay on until the passenger's front air bag is reactivated.

- To reactivate the passenger's front air bag, insert the master key into the passenger's front air bag ON/OFF switch and turn it to the ON position.

The passenger's front air bag OFF indicator will go out and the passenger's front air bag ON indicator (👤) will

illuminate and stay on until the passenger's front air bag is deactivated.

⚠️ WARNING

The front air bag ON/OFF switch could turn by using a similar small rigid device. Always check the status of the front air bag ON/OFF switch and passenger's front air bag ON/OFF indicator.

* NOTICE

- When the passenger's front air bag ON/OFF switch is set to the ON position, the passenger's front air bag is activated and child or infant seat should not be installed on the front passenger seat.
- When the passenger's front air bag ON/OFF switch is set to the OFF position, the passenger's front air bag is deactivated.

⚠️ CAUTION

- If the passenger's front air bag ON/OFF switch is not working properly, the air bag warning light (🚫👤) on the instrument panel will illuminate. And, the passenger's front air bag OFF indicator (🚫👤) will not illuminate (The passenger's front air bag ON indicator comes on), the SRS Control Mod-

ule reactivate the passenger's front air bag and the passenger's front air bag will inflate in frontal impact crashes even if the passenger's front air bag ON/OFF switch is set to the OFF position. In this case, have the system inspected by a professional workshop. Kia recommends to visit an authorised Kia dealer/service partner.

- If the SRS air bag warning light blinks or does not illuminate when the ignition switch or ENGINE START/STOP button is turned to the ON position, or if it illuminates whilst the vehicle is being driven, have the system inspected by a professional workshop. Kia recommends to visit an authorised Kia dealer/service partner.

WARNING

- The driver is responsible for the proper position of the passenger's front air bag ON/OFF switch.
- Deactivate the passenger's front air bag only when the ignition switch or ENGINE START/STOP button is switched off, or the malfunction may occur in the SRS Control Module. And there may be a danger that the driver's and/or front passenger's and/or side and curtain air bag may fail to trigger, or not trigger correctly during a collision.

- Never install a rearward facing child seat on the front passenger's seat unless the passenger's front air bag has been deactivated. The infant or child could be severely injured or killed by an air bag deployment in case of an accident.
- Even though your vehicle is equipped with the passenger's front air bag ON/OFF switch, do not install a child restraint system in the front passenger's seat. A child restraint system must never be placed in the front seat. Children who are too large for child restraint systems should always occupy the rear seat and use the available lap/shoulder belts. Children are afforded the most safety in the event of an accident when they are restrained by a proper restraint system in the rear seat.
- As soon as the child seat is no longer needed on the front passenger's seat, reactivate the front passenger's air bag.
- Never place or insert any object into any small opening near side airbag labels attached to the vehicle seats. When the air bag deploys, the object may affect the deployment and result in unexpected accident or bodily harm.

⚠ WARNING

No attaching objects

No objects (such as crash pad cover, mobile phone holder, cup holder, perfume or stickers) should be placed over or near the air bag modules on the steering wheel, instrument panel, windscreen glass, and the front passenger's panel above the glove box. Such objects could cause harm if the vehicle is in a crash severe enough to cause the air bags to deploy. Do not place any objects over the air bag or between the air bag and yourself.

Side air bag and front centre air bag

Your vehicle is equipped with a side air bag in each front seat.

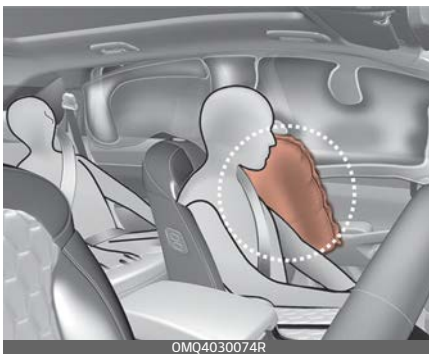

* The actual air bags in the vehicle may differ from the illustration.

The purpose of the air bag is to provide the vehicle's driver and/or the front passenger with additional pro-

tection than that offered by the seat belt alone.

The side air bags and driver's centre air bag are designed to deploy only during certain side-impact collisions, depending on the crash severity, angle, speed and point of impact. The side air bags and driver's centre air bag are not designed to deploy in all side impact situations.



* The actual air bags in the vehicle may differ from the illustration.

⚠ WARNING

Do not allow the passengers to lean their heads or bodies onto doors, put their arms on the doors, stretch their arms out of the window, or place objects between the doors and passengers when they are seated on seats equipped with side and/or curtain air bags.

*** NOTICE****Rollover sensor**

- Also, both side of the side air bags deploy in certain rollover situations.
- The side air bag may deploy when the rollover sensor detects the situation as a rollover.

⚠ WARNING

- The side air bag and driver's centre air bag are supplemental to the driver's and the passenger's seat belt systems and is not a substitute for them. Therefore your seat belts must be worn at all times whilst the vehicle is in motion. The air bags deploy only in certain side impact or rollover conditions (Only vehicle equipped with rollover sensor) severe enough to cause significant injury to the vehicle occupants.

- For best protection from the side air bag system and to avoid being injured by the deploying side air bag, both front seat occupants should sit in an upright position with the seat belt properly fastened.
- Do not use any accessory seat covers.
- Use of seat covers could reduce or prevent the effectiveness of the system.
- To prevent unexpected deployment of the side air bag and driver's centre air bag that may result in personal injury, avoid impact to the side impact sensor when the ignition key is on.
- If the seat or seat cover is damaged, have the system serviced by a professional workshop. Kia recommends to visit an authorised Kia dealer/service partner.

⚠ WARNING**No attaching objects**

- Do not place any objects over the air bag or between the air bag and yourself. Also, do not attach any objects around the area the air bag inflates such as the door, side door glass, front and rear pillar.
- Do not place any objects between the door and the seat. They may

become dangerous projectiles if the side air bag inflates.

- Do not install any accessories on the side or near the side air bags.

Curtain air bag (if equipped)



* The actual air bags in the vehicle may differ from the illustration.

Curtain air bags are located along both sides of the roof rails above the front and rear doors.

They are designed to help protect the heads of the front seat occupants and the 2nd row outboard

seat occupants in certain side impact collisions.

The curtain air bags are designed to deploy during certain side impact collisions, depending on the crash severity, angle, speed and point of impact. The curtain air bags are not designed to deploy in all side impact situations, collisions from the front or rear of the vehicle or in most roll-over situations.

* NOTICE

If equipped with rollover sensor

- Also, both side of the side air bags deploy in certain rollover situations.
- The curtain air bag may deploy when the rollover sensor detects the situation as a rollover.

⚠ WARNING

- Do not hang heavy items on the coat hooks for safety reasons.
- In order for side and curtain air bags to provide the best protection, both front seat occupants and both outboard rear occupants should sit in an upright position with the seat belts properly fastened. Importantly, children should sit in a proper child restraint system in the rear seat.

- When children are seated in the rear outboard seats, they must be seated in the proper child restraint system. Make sure to put the child restraint system as far away from the door side as possible, and secure the child restraint system in a locked position.
- Do not allow the passengers to lean their heads or bodies onto doors, put their arms on the doors, stretch their arms out of the window, or place objects between the doors and passengers when they are seated on seats equipped with side and/or curtain air bags.
- Never try to open or repair any components of the curtain air bag system. If necessary, have the system serviced by a professional workshop. Kia recommends to visit an authorised Kia dealer/service partner.

Failure to follow the above mentioned instructions can result in injury or death to the vehicle occupants in an accident.

WARNING

No attaching objects

- Do not place any objects over the air bag. Also, do not attach any objects around the area the air bag inflates such as the door, side door glass, front and rear pillar, roof side rail.
 - Do not hang hard or breakable objects on the clothes hanger.
-

Air bag collision sensors



OMQ4031094R



* The actual shape and position of sensors may differ from the illustration.

1. Supplemental Restraint System (SRS) control module/rollover sensor
2. Front impact sensor
3. Side pressure sensors (front door) (if equipped)
4. Side impact sensor (B-pillar) (if equipped)
5. Side impact sensor (C-pillar) (if equipped)

*: if equipped

⚠ WARNING

- Do not hit or allow any objects to impact the locations where air bag or sensors are installed. This may cause unexpected air bag deployment, which could result in serious personal injury or death.
- If the installation location or angle of the sensors is altered in any way, the air bags may deploy when they should not or they may not deploy when they should, causing severe injury or death. Therefore, do not try to perform maintenance on or around the air bag sensors. Have the system serviced by a professional workshop. Kia recommends to visit an authorised Kia dealer/service partner.
- Problems may arise if the sensor installation angles are changed due to the deformation of the front bumper, body or B pillar where side collision sensors are installed. In this case, have the system serviced by a professional workshop. Kia recommends to visit an authorised Kia dealer/service partner.
- Your vehicle has been designed to absorb impact and deploy the air bag(s) in certain collisions. Installing bumper guards or replacing a bumper with non-genuine parts

may adversely affect your vehicle collision and air bag deployment performance.

⚠ WARNING**If equipped with rollover sensor**

If your vehicle is equipped with side and curtain air bag, set the ignition switch or ENGINE START/STOP button to OFF or ACC position and wait for 3 minutes when the vehicle is being towed.

The side and curtain air bag may deploy when the ignitions is ON or the ignition is OFF within 3 minutes, and the rollover sensor detects the situation as a rollover.

Why didn't my air bag go off in a collision? (Inflation and non-inflation conditions of the air bag)

There are many types of accidents in which the air bag would not be expected to provide additional protection.

These include rear impacts, second or third collisions in multiple impact accidents, as well as low speed impacts.

Air bag inflation conditions

Front air bags



Front air bags are designed to inflate in a frontal collision depending on the intensity, speed or angles of impact of the front collision.

Side and curtain air bags

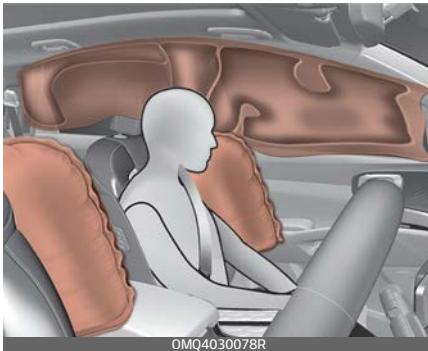

* The actual air bags in the vehicle may differ from the illustration.

Side and/or curtain air bags are designed to inflate when an impact is detected by side collision sensors depending on the strength, speed or angles of impact resulting from a side impact collision.

Also, the side and curtain air bags are designed to inflate when a roll-over is detected by a rollover sensor.

Although the front air bags (driver's and front passenger's air bags) are designed to inflate only in frontal collisions, they also may inflate in other types of collisions if the front impact sensors detect a sufficient impact. Side air bags (side and/or curtain air bags) are designed to inflate only in side impact collisions, but they may inflate in other collisions if the side impact sensors detect a sufficient impact.

For instance, side airbag and curtain air bags may inflate if rollover sen-

sors indicate the possibility of a roll-over occurring (even if none actually occurs) or in other situations, including when the vehicle is tilted whilst being towed. Even if side and/or curtain air bags do not provide impact protection in a rollover, they will deploy to prevent ejection of occupants, especially those who are restrained with seat belts.

If the vehicle chassis is impacted by bumps or objects on unimproved roads or sidewalks, air bags may deploy. Drive carefully on unimproved roads or on surfaces not designed for vehicle traffic to prevent unintended air bag deployment.

*** NOTICE**

If equipped with rollover sensor

Also, the side and curtain air bags are designed to inflate when a rollover is detected by a rollover sensor.

Air bag non-inflation conditions

- In certain low-speed collisions the air bags may not deploy. The air bags are designed not to deploy in such cases because they may not provide benefits beyond the protection of the seat belts in such collisions.



- Air bags are not designed to inflate in rear collisions, because occupants are moved backward by the force of the impact. In this case, inflated air bags would not be able to provide any additional benefit.



- Front air bags may not inflate in side impact collisions, because occupants move to the direction of the collision, and thus in side impacts, frontal air bag deployment would not provide additional occupant protection.



- However, if equipped with side and curtain air bags, the air bags may inflate depending on the intensity, vehicle speed and angles of impact.
- In an angled collision, the force of impact may direct the occupants in a direction where the air bags would not be able to provide any additional benefit, and thus the sensors may not deploy any air bags.



- Just before impact, drivers often brake heavily. Such heavy braking lowers the front portion of the vehicle causing it to "ride" under a

vehicle with a higher ground clearance. Air bags may not inflate in this "under-ride" situation because deceleration forces that are detected by sensors may be significantly reduced by such "under-ride" collisions.

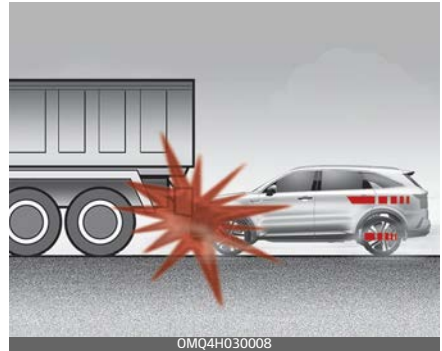

- Air bags may not inflate in roll-over accidents because the vehicle can not detect rollover accident. However, side and/or curtain air bags may inflate when the vehicle is rolled over following (or after) side impact collision.

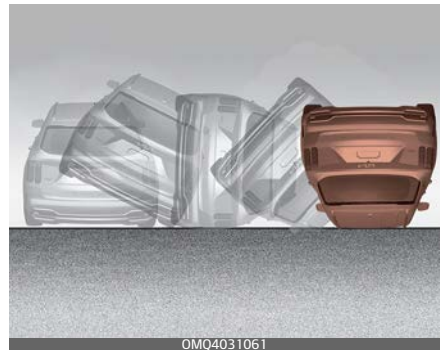

*** NOTICE**

However, side and/or curtain air bags may inflate when the vehicle is rolled over by a side impact collision, if the vehicle is equipped with side air bags and curtain air bags.

*** NOTICE**

If equipped with rollover sensor

However, if equipped with side and curtain air bags, the air bags may inflate in a rollover, when it is detected by the rollover sensor.

*** NOTICE**

without rollover sensor

However, side and/or curtain air bags may inflate when the vehicle is rolled over by a side impact collision, if the vehicle is equipped with side air bags and curtain air bags.

- Air bags may not inflate if the vehicle collides with objects such as utility poles or trees, where the point of impact is concentrated to one area and the full force of the impact is not delivered to the sensors.



SRS care

The SRS is virtually maintenance-free and so there are no parts you can safely service by yourself.

If the SRS air bag warning light does not illuminate, or continuously remains on, have the system inspected by a professional workshop. Kia recommends to visit an authorised Kia dealer/service partner.

⚠ WARNING

- Modification to SRS components or wiring, including the addition of any kind of badges to the pad covers or modifications to the body structure, can adversely affect SRS performance and lead to possible injury.
- For cleaning the air bag pad covers, use only a soft, dry cloth or one which has been moistened with plain water. Solvents or cleaners could adversely affect

the air bag covers and proper deployment of the system.

- No objects should be placed over or near the air bag modules on the steering wheel, instrument panel, and the front passenger's panel above the glove box, because any such object could cause harm if the vehicle is in a crash severe enough to cause the air bags to inflate.
- If the air bags inflate, have the system replaced by a professional workshop. Kia recommends to visit an authorised Kia dealer/service partner.
- Do not tamper with or disconnect SRS wiring, or other components of the SRS system. Doing so could result in injury, due to accidental inflation of the air bags or by rendering the SRS inoperative.
- If components of the air bag system must be discarded, or if the vehicle must be scrapped, certain safety precautions must be observed. An authorised Kia dealer knows these precautions and can give you the necessary information. Failure to follow these precautions and procedures could increase the risk of personal injury.
- If your car was flooded and has soaked carpeting or water on flooring, you shouldn't try to start the engine; in this case, have your vehicle inspected by a profes-

sional workshop. Kia recommends to contact an authorised Kia dealer/service partner.

Additional safety precautions

- **Never let passengers ride in the cargo area or on top of a folded-down back seat.** All occupants should sit upright, fully back in their seats with their seat belts on and their feet on the floor.
- **Passengers should not move out of or change seats whilst the vehicle is moving.** A passenger who is not wearing a seat belt during a crash or emergency stop can be thrown against the inside of the vehicle, against other occupants, or out of the vehicle.
- **Each seat belt is designed to restrain one occupant.** If more than one person uses the same seat belt, they could be seriously injured or killed in a collision.
- **Do not use any accessories on seat belts.** Devices claiming to improve occupant comfort or reposition the seat belt can reduce the protection provided by the seat belt and increase the chance of serious injury in a crash.
- **Passengers should not place hard or sharp objects between themselves and the air bags.** Carrying hard or sharp objects on your lap or in your mouth can result in injuries if an air bag inflates.

- **Keep occupants away from the air bag covers.** All occupants should sit upright, fully back in their seats with their seat belts on and their feet on the floor. If occupants are too close to the air bag covers, they could be injured if the air bags inflate.
- **Do not attach or place objects on or near the air bag covers.** Any object attached to or placed on the front or side air bag covers could interfere with the proper operation of the air bags.
- **Do not modify the front seats.** Modification of the front seats could interfere with the operation of the supplemental restraint system sensing components or side air bags.
- **Do not place items under the front seats.** Placing items under the front seats could interfere with the operation of the supplemental restraint system sensing components and wiring harnesses.
- **Never hold an infant or child on your lap.** The infant or child could be seriously injured or killed in the event of a crash. All infants and children should be properly restrained in appropriate child safety seats or seat belts in the rear seat.

WARNING

- Sitting improperly or out of position can cause occupants to be shifted too close to a deploying air bag, strike the interior structure or be thrown from the vehicle resulting in serious injury or death.
- Always sit upright with the seat-back in an upright position, centred on the seat cushion with your seat belt on, legs comfortably extended and your feet on the floor.

Adding equipment to or modifying your air bag-equipped vehicle

If you modify your vehicle by changing your vehicle's frame, bumper system, front end or side sheet metal or ride height, this may affect the operation of your vehicle's air bag system.

Air bag warning labels

Air bag warning labels are attached to alert passengers of potential risk of air bag system.



Note that these government warnings focus on the risk of children. We also want you to be aware of the risks adult are exposed to which have been described in previous pages.

Keys	5-7
• Record your key number	5-7
• Battery replacement	5-7
• Remote key	5-8
• Smart key	5-10
• Mechanical key.....	5-12
• Theft-alarm system.....	5-13
• Immobiliser system	5-17
• Door locks	5-18
Driver Position Memory System	5-27
• Storing memory positions	5-27
• Recalling memory positions	5-28
• Driver position memory system reset	5-28
• Easy access function	5-29
Tailgate	5-29
• Opening the tailgate	5-30
• Closing the tailgate	5-30
• Emergency tailgate safety release	5-31
Power tailgate	5-32
• Opening the tailgate	5-34
• Closing the tailgate	5-35
• Power tailgate non-opening conditions	5-35
• How to reset the power tailgate	5-37
• Power tailgate speed adjustment	5-37
• Power tailgate opening height.....	5-37
• Power tailgate opening height user setting	5-38
Smart Tailgate with Auto Open	5-39
• How to use the Smart Tailgate with Auto Open.....	5-39

5 Features of your vehicle

• How to deactivate the Smart Tailgate with Auto Open function using the smart key	5-41
• Detecting area.....	5-41
Windows	5-43
• Window opening and closing.....	5-45
• Power window lock button	5-46
Bonnet	5-49
• Opening the bonnet	5-49
• Bonnet open warning.....	5-49
• Closing the bonnet.....	5-50
Fuel filler door	5-51
• Opening the fuel filler door (Hybrid vehicle)	5-51
• Opening the fuel filler door (Plug-in hybrid vehicle).....	5-52
• Closing the fuel filler door	5-54
Panorama sunroof	5-56
• Power sunshade	5-57
• Tilt open/close.....	5-58
• Slide open/close	5-58
• Automatic reversal.....	5-58
• Resetting the sunroof	5-59
• Sunroof open warning	5-60
Steering wheel.....	5-61
• Electric power steering (EPS).....	5-61
• Tilt & telescopic steering wheel	5-62
• Heated steering wheel	5-63
• Horn	5-65
Mirrors	5-65
• Inside rear view mirror	5-65
• Outside rear view mirror	5-66

Instrument cluster	5-71
• Full LCD cluster	5-72
• Gauges.....	5-73
• Transmission shift indicator	5-78
LCD display	5-80
• LCD display modes	5-81
LCD displays	5-92
• Trip information (trip computer)	5-92
• Service mode.....	5-96
• Driving info display.....	5-96
• LCD display messages	5-97
Warning and indicator lights	5-105
• Warning lights	5-105
• Indicator lights	5-113
Head-Up Display (HUD)	5-117
• Head Up Display Information	5-118
• Head-Up Display Setting.....	5-119
Rear View Monitor (RVM)	5-119
• Function settings.....	5-120
• Function operation.....	5-121
• Malfunction and limitations.....	5-122
Surround View Monitor (SVM)	5-124
• Function settings.....	5-125
• Function operation.....	5-126
• Malfunction and limitations.....	5-127
Reverse Parking Distance Warning (PDW)	5-128
• Reverse Parking Distance Warning Settings	5-128
• Reverse Parking Distance Warning Operation.....	5-129

5 Features of your vehicle

- Reverse Parking Distance Warning..... 5-129
- Reverse Parking Distance Warning Malfunction and Precautions 5-130
- Forward/Reverse Parking Distance Warning (PDW) 5-132**
- Detecting sensor 5-132
- Forward/Reverse Parking Distance Warning Settings 5-133
- Forward/Reverse Parking Distance Warning Operation 5-133
- Forward/Reverse Parking Distance Warning Malfunction and Precautions 5-136
- Lighting 5-138**
- Battery saver function 5-138
- Headlight escort function..... 5-138
- Daytime Running Light (DRL) 5-138
- Lighting control..... 5-139
- Operating high beam 5-140
- Operating turn signals and lane change signals..... 5-141
- Operating front fog light 5-142
- Operating rear fog light 5-143
- High Beam Assist (HBA) 5-143
- Headlight levelling adjustment switch 5-146
- Wipers and washers 5-147**
- Auto control..... 5-149
- Operating windscreen washers..... 5-150
- Operating rear window wiper and washer switch..... 5-151
- Welcome system..... 5-152**
- Interior lights 5-153**
- Automatic turn off function 5-153

• Map lamp	5-154
• Room lamp	5-155
• Luggage room lamp	5-155
• Vanity mirror lamp	5-156
• Glove box lamp	5-156
Climate control system	5-157
• System operation	5-157
• Climate control air filter	5-159
• Air conditioning refrigerant label	5-159
• Checking the amount of air conditioner refrigerant and compressor lubricant	5-160
Automatic climate control system	5-162
• Heating and air conditioning automatically	5-164
• Heating and air conditioning manually	5-166
Windscreen defrosting and defogging	5-172
• Defogging inside windscreen	5-173
• Defrosting outside windscreen	5-173
• Auto defogging system	5-173
• Defroster	5-174
• Defogging logic	5-175
Storage compartment	5-176
• Centre console storage	5-177
• Glove box	5-177
Interior features	5-178
• Ambient light	5-178
• Ashtray	5-179
• Cup holder	5-179
• Seat warmer	5-180
• Air ventilation seat	5-182

5 Features of your vehicle

• Sun visor	5-183
• USB charger	5-183
• Power outlet.....	5-185
• Wireless smart phone charging system	5-186
• Coat hook	5-189
• Side curtain.....	5-189
• Floor mat anchors	5-190
• Luggage net holder	5-190
• Cargo security screen	5-191
• Luggage board	5-193
• Luggage tray.....	5-193
• Luggage side tray.....	5-194
Exterior features	5-194
• Roof rack.....	5-194
Infotainment system	5-196
• Audio system	5-196

Features of your vehicle

Keys

Record your key number

The key code number is stamped on the key code tag attached to the key set.

If you lose your keys, Kia recommends to contact an authorised Kia dealer/service partner. Remove the key code tag and store it in a safe place. Also, record the key code number and keep it in a safe place (not in the vehicle).

⚠ WARNING

Never leave the keys in your vehicle

Leaving children unattended in a vehicle with the keys is dangerous even if the vehicle is ACC or ON position.

Unattended children could place the key in the ignition switch or press the ENGINE START/STOP button and may operate power windows or other controls, or even make the vehicle move, which could result in SERIOUS BODILY INJURY OR EVEN DEATH. Never leave the keys in your vehicle with unsupervised children, when the engine is running.

Battery replacement

The remote key or smart key uses a 3 volt lithium battery which will normally last for several years.



When replacement is necessary, use the following procedure.

1. Insert a slim tool into the slot and gently pry open the remote key or smart key cover.
2. Replace the battery with a new battery (CR2032). When replacing the battery, make sure the battery position.
3. Install the battery in the reverse order of removal.

For remote key or smart key replacement, Kia recommends to visit an authorised Kia dealer/service partner.

⚠ WARNING

THIS PRODUCT CONTAINS A BUTTON BATTERY

If swallowed, a lithium button battery can cause severe or fatal injuries within 2 hours.

Keep batteries out of reach of children.

If you think batteries may have been swallowed or placed inside any part of the body, seek immediate medical attention.

⚠ CAUTION

- The remote key or smart key is designed to give you years of trouble-free use, however it can malfunction if exposed to moisture or static electricity. If you are unsure how to use or replace the battery, Kia recommends to contact an authorised Kia dealer/service partner.
- Using the wrong battery can cause the remote key or smart key to malfunction. Be sure to use the correct battery.
- To avoid damaging the remote key or smart key, don't drop it, get it wet, or expose it to heat or sunlight.

⚠ CAUTION



An inappropriately disposed battery can be harmful to the environment and human health.

Dispose the battery according to your local law(s) or regulation.

Remote key

With a remote key, you can lock or unlock the door and tailgate.



Lock (1)

All doors are locked if the lock button is pressed whilst all doors are closed.

The hazard warning lights will blink once to indicate that all doors are locked.

However, if any door, engine bonnet or tailgate remains open, the hazard warning lights will not operate. If all doors, engine bonnet and tailgate are closed after the lock button is pressed, the hazard warning lights will blink once.

Unlock (2)

All doors are unlocked if the unlock button is pressed.

The hazard warning lights will blink twice to indicate that all doors are unlocked.

After pressing this button, the doors will lock automatically unless you open any door within 30 seconds.

Tailgate open (3)

If you press this button for longer than a second, the lock will be released.

Once the tailgate is opened and then closed, the tailgate will lock automatically.

*** NOTICE**

To prevent damaging the remote key:

- Keep the remote key away from water or any liquid and fire. If the inside of the remote key gets damp (due to drinks or moisture), or is heated, internal circuit may malfunction, excluding the car from the warranty.
- Avoid dropping or throwing the remote key.
- Protect the remote key from extreme temperatures.

⚠ WARNING

Kia recommends to use parts for replacement from an authorised Kia dealer/service partner. If an after-market key is used, the ignition switch may not return to ON after START. If this happens, the starter will continue to operate causing damage to the starter motor and possible fire due to excessive current in the wiring.

Mechanical key

If the remote key does not operate normally, you can lock or unlock the door by using the mechanical key.



To unfold the key:

- press the release button then the key will unfold automatically.

To fold the key:

- fold the key manually whilst pressing the release button.

⚠ CAUTION

Do not fold the key without pressing the release button. This may damage the key.

Transmitter precautions*** NOTICE**

The transmitter will not work if any of the following occurs:

- The ignition key is in the ignition switch.
- You exceed the operating distance limit (about 10 m [30 feet]).
- The battery in the transmitter is weak.
- Other vehicles or objects may be blocking the signal.
- The weather is extremely cold.
- The transmitter is close to a radio transmitter such as a radio station or an airport which can interfere with normal operation of the transmitter.

When the transmitter does not work correctly, open and close the door with the ignition key. If you have a problem with the transmitter Kia recommends to contact an authorised Kia dealer/service partner.

- If the transmitter is in close proximity to your cell phone or smart phone, the signal from the transmitter could be blocked by normal operation of your cell phone or smart phone. This is especially important when the phone is active such as making call, receiving calls, text messaging, and/or sending/receiving emails. Avoid placing the transmitter and your cell phone or smart phone in the same pants or jacket pocket and maintain adequate distance between the two devices.

Smart key (if equipped)

With a smart key, you can lock or unlock a door and even start the engine without inserting the key.

Type A



OMQ4041499L

Type B



0MQ4041501L

Lock (1)

All doors are locked if the lock button is pressed whilst all doors are closed.

The hazard warning lights will blink once to indicate that all doors are locked.

However, if any door, engine bonnet or tailgate remains open, the hazard warning lights will not operate. If all doors, engine bonnet and tailgate are closed after the lock button is pressed, the hazard warning lights will blink once.

Unlock (2)

All doors are unlocked if the unlock button is pressed.

The hazard warning lights will blink twice to indicate that all doors are unlocked.

After pressing this button, the doors will lock automatically unless you open any door within 30 seconds.

Tailgate unlock/Power Tailgate unlock/open(3)

If you press this button for longer than a second, the lock will be released or the tailgate will be opened according to the options of the vehicle.

Once the tailgate is opened and then closed, the tailgate will lock automatically.

Remote start (4) (if equipped)

You can start the vehicle using the remote start button (4) of the smart key.

To start the vehicle remotely:

- Lock the doors by pressing the door lock button (1) within 10 m (32 feet) distance from the vehicle.
- Press the remote start button for over 2 seconds within 4 seconds after locking the doors.

Press the remote start button once to turn off the vehicle.

If no further action for operating/driving the vehicle is taken, the vehicle will be turned off 10 minutes after starting the vehicle remotely.

Remote smart parking assist (RSPA) (5, 6) (if equipped)

The Remote smart parking assist (RSPA) helps the drivers park their vehicle by using sensors to measure parking spaces and control the steering wheel, gear shift and vehicle speed to semi-automatically park the vehicle. With the smart key, the driver can move the vehicle forward or backward using the forward/ backward buttons (5, 6) on the smart key. For more information, refer to .

Start-up

You can start the vehicle without inserting the key.

* For more information, refer to "ENGINE START/STOP button (if equipped)" on page 6-12.

Mechanical key

If the smart key does not operate normally, you can lock or unlock the door by using the mechanical key.



To pull out the mechanical key:

- press and hold the release button (1) and remove the mechanical key (2).

To reinstall the mechanical key:

- put the key into the hole and push it until a click sound is heard.

Smart key precautions

*** NOTICE**

- If, for some reason, you happen to lose your smart key, you will not be able to start the engine. Tow the vehicle, if necessary, contact a professional workshop. Kia recommends to contact an authorised Kia dealer/service partner.
- A maximum of 2 smart keys can be registered to a single vehicle. If you lose a smart key, Kia recommends to contact an authorised Kia dealer/service partner.
- The smart key will not work if any of the following occurs:

- The smart key is close to a radio transmitter such as a radio station or an airport which can interfere with normal operation of the smart key.
- The smart key is near a mobile two-way radio system or a mobile phone.
- Another vehicle's smart key is being operated close to your vehicle.

When the smart key does not work properly, open and close the door with the mechanical key. If you have a problem with the smart key, Kia recommends to contact an authorised Kia dealer/service partner.

Theft-alarm system

Theft-alarm system is designed to provide protection from unauthorised entry into the vehicle.

Vehicles equipped with a theft alarm system will have a label attached to the vehicle with the following words:

1. WARNING
2. SECURITY SYSTEM



This system is operated in three stages:

- Armed stage
- Theft-alarm stage
- Disarmed stage

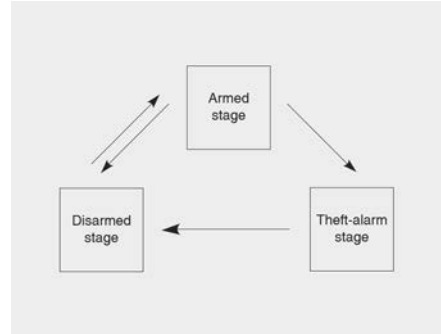

If triggered, the system provides an audible alarm with blinking of the hazard warning lights.

CAUTION

Do not attempt to alter this system or add other devices to it.

Armed stage

Theft Alarm System goes to Armed stage after 30 seconds from the doors are locked by switch on a Outside Door Handle/by a lock button on the Key.

Using the smart key

Park the vehicle and stop the engine. Arm the system as described below.

1. Turn off the engine.

2. Make sure that all doors (and tailgate) and the engine bonnet are closed and latched.
3. Do one of the following:
 - Lock the doors by pressing the button of the front outside door handle with the smart key in your possession. After completion of the steps above, the hazard warning lights operate once to indicate that the system is armed. If any door remains open, the doors won't lock and the chime will sound for 3 seconds. Close the door and try again to lock the doors. If tailgate or engine bonnet remains open, the hazard warning lights won't operate and theft-alarm will not arm. After this, if the tailgate and engine bonnet are closed, the hazard warning lights will blink once.
 - Lock the doors by pressing the button of the front outside door handle with the smart key in your possession. After completion of the steps above, the hazard warning lights operate once to indicate that the system is armed. If any door remains open, the doors won't lock and the chime will sound for 3 seconds. Close the door and try again to lock the doors. If tailgate or engine bonnet remains open, the hazard

warning lights won't operate and theft-alarm will not arm. After this, if the tailgate and engine bonnet are closed, the hazard warning lights will blink once.

- Lock the doors by pressing the lock button on the smart key. After completion of the steps above, the hazard warning lights will operate once to indicate that the system is armed. If any door (and tailgate) or engine bonnet remains open, the hazard warning lights won't operate and theft-alarm will not arm. After this, if all doors (and tailgate) and engine bonnet are closed, the hazard warning lights blink once.

Using the remote key

Park the vehicle and stop the engine. Arm the system as described below.

1. Turn off the engine and remove the ignition key from the ignition switch.
2. Make sure that all doors (and tailgate), the engine bonnet are closed and latched.
3. Lock the doors by pressing the lock button on the remote key. After completion of the steps above, the hazard warning lights will blink once to indicate that the system is armed. If any door (and

tailgate) or engine bonnet remains open, the hazard warning lights won't operate and theft-alarm will not arm. After this, if all doors (and tailgate) and engine bonnet are closed, the hazard warning lights blink once.

Ultrasonic Intrusion Protection (UIP) (if equipped)



OMQ404052 1R

- To cancel the sensor operation, go to 'Settings → Convenience' and turn Ultrasonic Intrusion Protection to OFF.
- If the system is armed when the sensor is in the OFF status, the intrusion/tilt sensor will not operate.

Then, the alarm will be activated when the system meets the intrusion/tilt sensor off condition of "Theft-alarm" stage.

To reactivate the sensor operation, go to 'Settings → Convenience' and turn Ultrasonic Intrusion Protection to ON again.

⚠ CAUTION

- Do not activate the sensor if there are any chances the vehicle tilts by the outward influences (for example, ferry boat travelling, tower parking etc.), because it could cause the siren to sound inadvertently.
- Make sure all windows are close whilst the system operates. If not, the sensor detects the inadvertent movement inside the vehicle (for example, blowing a wind or entering a butterfly) and it makes the siren sounds.
- If boxes are piled high in the vehicle, the sensor may not detect the movement behind the boxes. Also the boxes may drop and it makes the siren sounds.
- If the sensor is stained with foreign matter such as cosmetics, spray type air freshener, or spray type window cleaner, the sensor may not operate normally.

Theft-alarm stage

The alarm will be activated if any of the following occurs whilst the system is armed.

- A door is opened without using the remote key or smart key.
- The tailgate is opened without using the remote key or smart key.
- The engine bonnet is opened.

The horn will sound and the hazard warning lights will blink continuously for approximately 30 seconds. To turn off the system, unlock the doors with the remote key or smart key.

Ultrasonic Intrusion Protection (UIP) OFF condition

The alarm will be activated if any of the following occurs whilst the system is armed.

- A front or rear door is opened without using the transmitter (or smart key).
- The tailgate is opened without using the transmitter (or smart key).
- The bonnet is opened.
- The ignition switch or ENGINE START/STOP button is in the ON position.

*** NOTICE**

Ultrasonic Intrusion Protection is in ON position whenever the vehicle engine is started again.

Ultrasonic Intrusion Protection (UIP) ON condition

The alarm will be activated if any of the following occurs whilst the system is armed when the sensor is activated.

- The passenger(s) moves in the vehicle.

- The inclination of the vehicle is changed to the certain degree.
- A front or rear door is opened without using the transmitter (or smart key).
- The tailgate is opened without using the transmitter (or smart key).
- The bonnet is closed.
- The ignition switch or ENGINE START/STOP button is in the OFF position.

The siren will sound and the hazard warning lights will blink continuously for approximately 27 seconds and repeat max. 8 times when the system meets the alarm activation condition.

To turn off the system, unlock the doors with the transmitter (or smart key).

Disarmed stage

The system will be disarmed when:

Remote key

- The door unlock button is pressed.
- The engine is started.
- The vehicle is in the "ON" position for 30 seconds or more.

Smart key

- The door unlock button is pressed.

- The button of the front outside door is pressed whilst carrying the smart key.
- The engine is started.

After the doors are unlocked, the hazard warning lights will blink twice to indicate that the system is disarmed.

After pressing the unlock button, if any door (or tailgate) is not opened within 30 seconds, the system will be rearmed.

Immobiliser system

Your vehicle is equipped with an electronic engine immobiliser system to reduce the risk of unauthorised vehicle use.

Your immobiliser system is comprised of a small transponder in the ignition switch and electronic devices inside the vehicle.

Vehicles without smart key system

With the immobiliser system, whenever you insert your ignition key into the ignition switch and turn it to ON, it checks and determines and verifies if the ignition key is valid or not.

If the key is valid, the engine will start.

If the key is invalid, the engine will not start.

To deactivate the immobiliser system:

Insert the ignition key into the key cylinder and turn it to the ON position.

To activate the immobiliser system:

Turn the ignition key to the OFF position. The immobiliser system activates automatically. Without a valid ignition key for your vehicle, the engine will not start.

Vehicles with smart key system

Whenever the ENGINE START/STOP buttons are changed to the ON position, the immobiliser system checks and verifies if the key is valid or not.

If the key is valid, the engine will start.

If the key is invalid, the engine will not start.

To deactivate the immobiliser system

Change the ENGINE START/STOP button to the ON position.

To activate the immobiliser system

Change the ENGINE START/STOP button to the OFF position. The immobiliser system activates automatically. Without a valid smart key for your vehicle, the engine will not start.

⚠ WARNING

In order to prevent theft of your vehicle, do not leave spare keys anywhere in your vehicle. Your immobiliser password is a customer unique password and should be kept confidential. Do not leave this number anywhere in your vehicle.

*** NOTICE**

When starting the engine, do not use the key with other immobiliser keys around. Otherwise the engine may not start or may stop soon after it starts. Keep each key separately in order to avoid a starting malfunction.

⚠ CAUTION

Do not put metal accessories near the ignition switch. Metal accessories may interrupt the transponder signal and may prevent the engine from being started.

*** NOTICE**

If you need additional keys or lose your keys, Kia recommends to visit an authorised Kia dealer/service partner.

⚠ CAUTION

The transponder in your ignition key is an important part of the immobiliser system. It is designed to give years of trouble-free service, however you should avoid exposure to moisture, static electricity and rough handling. immobiliser system malfunction could occur.

⚠ CAUTION

Do not change, alter or adjust the immobiliser system because it could cause the immobiliser system to malfunction. In this case, have the system serviced by a professional workshop. Kia recommends to visit an authorised Kia dealer/service partner.

Malfunctions caused by improper alterations, adjustments or modifications to the immobiliser system are not covered by your vehicle manufacturer warranty.

Door locks

Know how to use the door lock so that you can lock or unlock the door if necessary.

With the smart key

Carrying the smart key, you may lock and unlock the vehicle doors (and tailgate). Also, you may start the engine. Refer to the following for more details.

Locking

Pressing the button of the front driver side door handles with all doors closed and any door unlocked, locks all the doors. If all doors and engine bonnet are closed, the hazard warning lights will blink once to indicate that all doors are locked.

The button will only operate when the smart key is within 0.7 ~ 1 m (28 ~ 40 inches) from the driver side door handle. If you want to make sure that a door has locked or not, you should pull the driver side door handle.

Even though you press the driver side door handle buttons, the doors will not lock and the chime will

sound for 3 seconds if any of following occur:

- The smart key is in the vehicle.
- The ENGINE START/STOP button is in the ACC or ON position.
- Any door except the tailgate is open.

Unlocking

Pressing the button of the front driver side door handles with all doors closed and locked, unlocks all the doors. The hazard warning lights blink twice to indicate that all doors are unlocked.

The button will only operate when the smart key is within 0.7 ~ 1 m (28 ~ 40 inches) from the front driver side door handle.

When the smart key is recognised in the area of 0.7 ~ 1 m (28 ~ 40 inches) from the front driver side door handle, other people can also open the door without possession of the smart key.

After pressing the button, the doors will lock automatically unless you open any door within 30 seconds.

With the mechanical key

1. Pull out the door handle.
 2. Press the lever (1) located inside the bottom part of the cover with a key or flat-head screwdriver.
 3. Push out the cover (2) whilst pressing the lever.
 4. Turn the key toward the rear of the vehicle to unlock and toward the front of the vehicle to lock (only the driver's door can be locked/unlocked).
- Doors can also be locked and unlocked with the transmitter.
 - Once the doors are unlocked, they may be opened by pulling the door handle.
 - When closing the door, push the door by hand. Make sure the doors are closed securely.

*** NOTICE**

- When locking the door with a mechanical key, be aware that only the driver's door can be locked/unlocked.

- To lock all doors, operate the central lock switch inside the vehicle. Open the car door using the inner handle, then close the door and lock the driver's door with a mechanical key.
- Refer to "Operating door locks from inside the vehicle" on page 5-20.

*** NOTICE**

- Be careful not to lose or scratch the cover when removing it.
- When the key cover freezes and does not open, tap it lightly or indirectly warm (hand temperature, etc.) it up.
- Do not apply excessive force to the door and door handle. It may be damaged.

Operating door locks from inside the vehicle

You can operate door locks with the door lock handle or central door lock switch.

With the door handle



- Front door
If the inner door handle is pulled when the door is locked, the door will unlock and open.
- Rear door
If the inner door handle is pulled once when the door is locked, the door will unlock.
If the inner door handle is pulled once more, the door will open.

⚠ WARNING

Door lock malfunction

If a power door lock ever fails to function whilst you are in the vehicle, try one or more of the following techniques to exit:

- Operate the door unlock feature repeatedly (both electronic and manual) whilst simultaneously pulling on the door handle.
- Operate the other door locks and handles, front and rear.

- Lower a front window and use the key to unlock the door from outside.
- Move to the cargo area and open the tailgate.

⚠ WARNING

Do not pull the inner door handle of driver's (or passenger's) door whilst the vehicle is moving.

With central door lock switch

Driver side



Passenger side



1. Door Lock

2. Door Unlock
3. Doors indicating light

Operate by pressing the central door lock switch.

- To lock all vehicle doors, press the central door lock switch (1) of driver and passenger side.
- To unlock all vehicle doors, press central door unlock switch (2) of driver and passenger side.

When all vehicle doors are locked, the indicating lights (3) on the driver's door and passenger's door will turn on. If any door is unlocked, it would go off.

If the key is in the ignition switch (or if the smart key is in the vehicle) and any door is opened, the doors will not lock even though the central door lock switch is pressed.

WARNING

Doors

- The doors should always be fully closed and locked whilst the vehicle is in motion to prevent accidental opening of the door. Locked doors will also discourage potential intruders when the vehicle stops or slows down.
- Be careful when opening doors and watch for vehicles, motorcycles, bicycles or pedestrians approaching the vehicle in the path of the door. Opening a door

when something is approaching can cause damage or injury.

WARNING

Unlocked vehicles

Leaving your vehicle unlocked can invite theft or possible harm to you or others from someone hiding in your vehicle whilst you are gone. Always remove the ignition key, engage the parking brake, close all windows and lock all doors when leaving your vehicle unattended.

WARNING

Unattended children

An enclosed vehicle can become extremely hot, causing death or severe injury to unattended children or animals who cannot escape the vehicle. Furthermore, children might operate features of the vehicle that could injure them, or they could encounter other harm, possibly from someone gaining entry to the vehicle. Never leave children or animals unattended in your vehicle.

Door lock/unlock features

The vehicle is equipped with door lock/unlock features for the safety and convenience of passengers.

Impact sensing door unlock system

All doors will automatically unlock when an impact causes the air bags to deploy.

Speed sensing door lock system

All doors will automatically lock after the vehicle speed exceeds 15 km/h.

You can activate or deactivate the auto door lock/unlock features in the vehicle. Refer to "User settings mode" on page 5-84.

Deadlocks (if equipped)

Some vehicles are equipped with deadlock system. Deadlocks prevent opening of a door from either inside or outside the vehicle once the deadlocks have been activated providing an additional measure of vehicle security.

To lock the vehicle using the deadlock function, the doors must be locked by using the smart key. To unlock the vehicle, the smart key must be used again.

Electronic child safety lock system (if equipped)

If you push the electronic child safety lock switch and the indicator illuminates, rear passengers cannot open the rear door from inside the vehicle.



To cancel the electronic child safety lock, push the electronic child safety lock switch one more time and then the indicator turns off.

Safe Exit Assist is operated when the electronic child safety lock is activated and SEA is selected in the cluster. However, SEA does not automatically activate the electronic child safety lock system.

The electronic child safety lock is always on when the ENGINE START/STOP button is in the ON or ignition ON state and for approximately 3 minutes after the engine is turned off.

If your vehicle is equipped with the Electronic child safety lock, the Child-protector rear door locks, which are manually operated, are not provided.

If electronic child safety lock is activated, rear passenger cannot open or close the rear window also. For more details, refer to "Windows" on page 5-43.

⚠ CAUTION

If the Electronic child safety lock is not operated when pushing the Electronic child safety lock switch, the message is displayed and the alarm will sound.



If this occurs, have the system checked by a professional workshop. Kia recommends to visit an authorised Kia dealer/service partner.

In case of an emergency

If the electrical power door lock switch is not operating (e.g. dead car battery) the only way to lock the door(s) is with the mechanical key from the outside key hole.

Doors without an outside key hole can be locked as follows:

1. Open the door.
2. Insert the key into the emergency door lock hole and turn the key to the lock position as shown.



3. Close the door securely.

*** NOTICE**

If the electrical power to door lock switch is not operating (e.g. dead car battery) and the tailgate is closed, you will not be able to open the tailgate until power is restored.

Child-protector rear door lock (if equipped)

The child safety lock is provided to help prevent children from accidentally opening the rear doors from inside the vehicle.



The rear door safety locks should be used whenever children are in the vehicle.

The child safety lock is located on the edge of each rear door. When the child safety lock is in the lock position (1), the rear door will not open if the inner door handle is pulled.

To lock the child safety lock, insert a key (or screwdriver) into the hole and turn it to the lock position.

To allow a rear door to be opened from inside the vehicle, unlock the child safety lock.

To open the rear door, pull the outside door handle (2).

⚠ WARNING

Rear door locks

If children accidentally open the rear doors whilst the vehicle is in motion, they could fall out and be severely injured or killed. To prevent children from opening the rear doors from the inside, the rear door safety locks should be used whenever children are in the vehicle.

⚠ WARNING

- The system does not detect every obstacle approaching the vehicle exit.
- The driver and passenger are responsible for the accident occurred whilst exiting the vehicle. Always check the surrounding before you exit the vehicle.

Rear Occupant Alert (ROA) System (if equipped)

The Rear Occupant Alert (ROA) is provided to help prevent exiting the vehicle with a rear passenger left in the vehicle.

- When you open the front door after opening and closing the rear door and turning off the engine, the "Check rear seats" warning message appears on the cluster.



You can activate or deactivate the ROA from the User Settings mode in the cluster LCD display. If your vehicle is equipped with an infotainment system, you can learn how to setup on the website via QR code in the infotainment quick reference guide.

The option can be found under the following menu:

1. Press the MODE button (📄) several times on the steering wheel until 'User Settings' menu appears on the LCD.
2. Select 'Convenience → Rear Occupant Alert' with the MOVE switch (↖️/↘️) and the OK button on the steering wheel.

If your vehicle is equipped with the infotainment system, the option can be found under the following menu:

1. Press the SETUP button of the infotainment system.
2. Press 'Vehicle → Convenience → Rear Occupant Alert' on the infotainment system screen.

⚠️ WARNING

The Rear Occupant Alert (ROA) system does not actually detect objects or people in the rear seat. By using a rear door opened and closed history, the system informs the driver that there may be something in the rear seat.

⚠️ CAUTION

- The Rear Occupant Alert (ROA) system uses a rear door opened and closed history.
- The history is reset after the driver turns off ignition normally, exits the vehicle and locks the door remotely using the remote keyless entry. So even if a rear door does not reopen, the ROA system alert can occur.
- For example, after the ROA system alert occurs, if the driver does not lock the door, and drives again, the alert can occur.

⚠️ WARNING

The door lock system may not work if the electrical system is compromised. Accordingly, please train children passengers regarding how to open the car door manually before an emergency situation arises. That way, they would be able to open the door manually in the event an emergency situation arises.

Driver Position Memory System (if equipped)

The Driver Position Memory System is provided to store and recall the following memory settings with a simple button operation.



- Driver's seat position
- Outside rearview mirror position
- Instrument panel illumination intensity
- Head Up Display (HUD) position and brightness (if equipped)

WARNING

Never attempt to operate the driver position memory system whilst the vehicle is moving.

This could result in loss of control, and an accident causing death, serious injury, or property damage.

*** NOTICE**

- If the battery is disconnected, the memory settings will be erased.
- If the Driver Position Memory System does not operate normally, we recommend that you have the system checked by an authorised Kia dealer/service partner.

Storing memory positions

1. The ignition switch or ENGINE START/STOP button is in the ON position.
2. Adjust the driver's seat position, outside rearview mirror position, instrument panel illumination intensity (if equipped) and head-up display height/brightness to the desired position.
3. Press the SET button. The system will beep once and notify you "Press button to save settings" on the LCD display.
4. Press one of the memory buttons (1 or 2) within 4 seconds. The system will beep twice when the memory has been successfully stored.
5. "Settings 1 (or 2) saved" will appear on the LCD display.

Recalling memory positions

1. The ignition switch or ENGINE START/STOP button is in the ON position.
2. Press the desired memory button (1 or 2). The system will beep once, and then the driver's seat position, outside rearview mirror position, instrument panel illumination intensity (if equipped) and head-up display height/brightness will automatically adjust to the stored positions.
3. "Settings 1 (or 2) applied" will appear on the LCD display.
 - Whilst recalling the "1" memory position, pressing the SET or 1 button temporarily stops the adjustment of the recalled memory position. Pressing the 2 button recalls the "2" memory position.
 - Whilst recalling the "2" memory position, pressing the SET or 2 button temporarily stops the adjustment of the recalled memory position. Pressing the 1 button recalls the "1" memory position.
 - Whilst recalling the stored positions, pressing one of the control buttons for the driver's seat, outside rearview mirror, or instrument panel illumination will cause the movement of that component to stop and move in the direction that the control button is pressed.

Driver position memory system reset

If the Driver position memory system does not work properly, initialise the system as follows.

How to initialise:

1. Stop the vehicle and open the driver's door with the ignition switch or ENGINE START/STOP button in the ON position and the vehicle shifted to P (Park).
2. Pull the driver's seat forward as far as possible and have the seat-back upright as much as possible using the driver's seat forward/backward adjustment and seat-back angle (recline) switches.
3. Push the SET button and seat forward movement switch for 2 seconds simultaneously.

Initialization in the process:

1. Initialization begins as the alarm sounds.
2. The seat and seatback will automatically move backwards. The alarm sound will continue whilst the system is in operation.
3. Initialization will be complete after the seat and seatback move to the centre with an alarm sound. If, however, cases as follows occur, the initialization process will come to a stop and the alarm sound will stop as well.
 - When pushing driving position memory system button

- When pushing driver's seat height adjustment switch
- When shifting from P (Park) to other positions
- When driving speed exceeds 3 km/h
- When the driver's door is closed

Easy access function (if equipped)

The system will move the driver's seat automatically as follows:

Without smart key system

- It will move the driver's seat rearward when the ignition key is removed and the driver's door is opened.
- It will move the driver's seat forward when the ignition switch is in the ACC or ON position.

With smart key system

- It will move the driver's seat rearward when the ENGINE START/STOP button is in the OFF position and the driver's door is opened.
- It will move the driver's seat forward when the vehicle is turned ON or the driver's door is closed with the smart key with you.

You can activate or deactivate the Easy Access Function from the User Settings Mode on the LCD display. For more details, refer to "LCD display" on page 5-80. If your vehicle is equipped with additional navigation, please refer to the infotainment system manual separately supplied.

Tailgate

WARNING

Exhaust fumes

If you drive with the tailgate open, you will draw dangerous exhaust fumes into your vehicle which can cause serious injury or death to vehicle occupants.

If you must drive with the tailgate open, keep the air vents and all windows open so that additional outside air comes into the vehicle.

WARNING

Rear cargo area

Occupants should never ride in the rear cargo area where no restraints are available. To avoid injury in the event of an accident or sudden stops, occupants should always be properly restrained.

Opening the tailgate

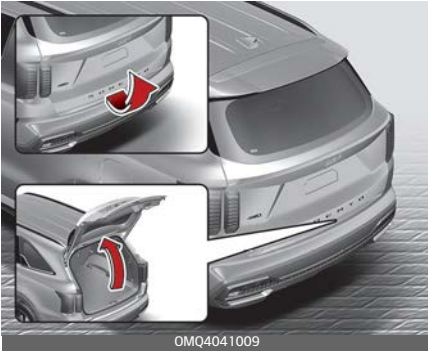

- The tailgate is locked or unlocked when all doors are locked or unlocked with the transmitter (or smart key) or central door lock switch.
- Only the tailgate is unlocked if the tailgate unlock button on the transmitter or smart key is pressed for approximately 1 second.
- If unlocked, the tailgate can be opened by pressing the handle and pulling it up.
- Once the tailgate is opened and then closed, the tailgate locks automatically. (All doors must be locked.)

* NOTICE

In cold and wet climates, door lock and door mechanisms may not work properly due to freezing conditions.

⚠ WARNING

The tailgate swings upward. Make sure no objects or people are near the rear of the vehicle when opening the tailgate.

⚠ CAUTION

Make certain that you close the tailgate before driving your vehicle. Possible damage may occur to the tailgate gas lifters and attached hardware if the tailgate is not closed prior to driving.

Closing the tailgate



- To close the tailgate, lower and push down the tailgate firmly. Make sure that the tailgate is securely latched.

⚠ WARNING

Make sure your hands, feet and other parts of your body are safely out of the way before closing the tailgate.

⚠ WARNING**Exhaust fumes**

The tailgate lid should be always kept completely closed whilst the vehicle is in motion. If it is left open or ajar, poisonous exhaust gases may enter the car and serious illness or death may result.

⚠ CAUTION

Make sure nothing is near the tailgate latch and striker whilst closing the tailgate. It may damage the tailgate's latch.

Emergency tailgate safety release

Your vehicle is equipped with the emergency tailgate safety release lever located on the bottom of the tailgate. When someone is inadvertently locked in the luggage compartment.

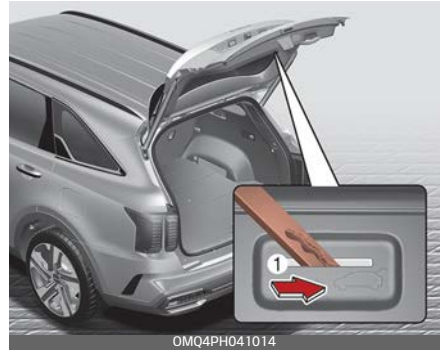

The tailgate can be opened by doing as follows:

1. Input the mechanical key into the hole.
2. Push the mechanical key to the right (1).
3. Push up the tailgate.

⚠ WARNING

- For emergencies, be fully aware of the location of the emergency tailgate safety release lever in the vehicle and how to open the tailgate if you are accidentally locked in the luggage compartment.
- No one should be allowed to occupy the cargo area of the vehicle at any time. The cargo area is a very dangerous location in the event of a crash.
- Use the release lever for emergencies only. Use with extreme caution, especially whilst the vehicle is in motion.

⚠ WARNING

Do not grasp the part supporting the liftgate (gas lifter), as this may cause serious injury.



Power tailgate (if equipped)

1. Power tailgate open/close button

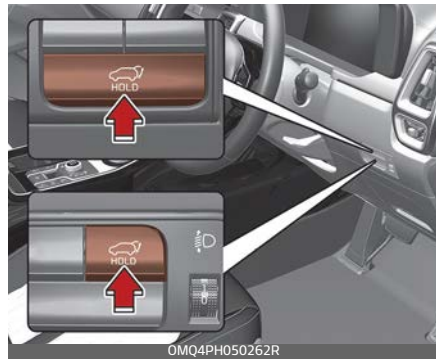

2. Power tailgate handle switch



3. Power tailgate close button



4. Power tailgate lock button



5. Power tailgate open button



*** NOTICE**

If ignition switch is ON position, the power tailgate can operate when the gear is in P (Park).

*** NOTICE**

Do not put heavy stuffs on the power tailgate when you operate the power tailgate. Additional weight on tailgate could cause damages to the system.

⚠ WARNING

Never leave children or animals unattended in your vehicle. Children or animals might operate the power tailgate that could result in injury to themselves or others, or damage the vehicle.

⚠ WARNING

Make sure that there are no people or objects in the path of the power tailgate (or smart tailgate) prior to use. Serious injury, damage to the vehicle or damage to surrounding objects may result if contact with the power tailgate (or smart tailgate) occurs.



⚠ CAUTION

Do not close or open the power tailgate manually. This may cause damage to the power tailgate. If it is necessary to close or open the power tailgate manually when the

battery is discharged or disconnected, do not apply excessive force.

⚠ WARNING

Make sure there are no people or objects around the tailgate before opening or closing the power tailgate. Wait until the tailgate is open fully and stopped before loading or unloading cargo from the vehicle.

Opening the tailgate

The power tailgate will open automatically by doing one of the following:

- Press the power tailgate open button on the smart key for approximately one second.



- Press the power tailgate open button for approximately one second.
- For emergency stop whilst power tailgate operating, press the power tailgate open/close button shortly.

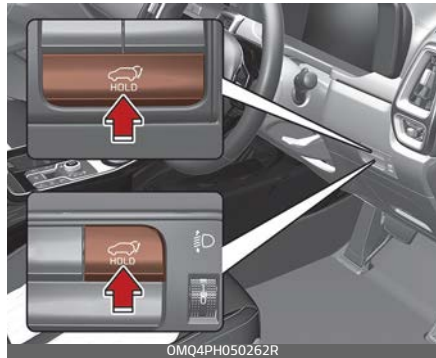

- Press the tailgate handle switch carrying the smart key with you. If all the doors are unlocked, the tailgate can be opened without the smart key.



Closing the tailgate

The power tailgate will close automatically by doing one of the following:

- Press the power tailgate close button for approximately one second when the tailgate is opened.

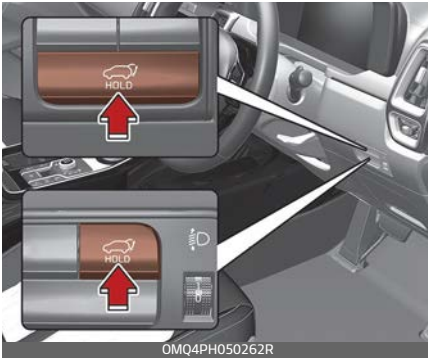

The tailgate will close and lock automatically.

- For emergency stop whilst power tailgate operating, press the power tailgate open/close button shortly.
- Press the power tailgate close button when the tailgate is opened.



The tailgate will close automatically.

- Press the power tailgate lock button when the tailgate is opened.



The tailgate will close and all the doors will lock automatically.

Power tailgate non-opening conditions

The power tailgate will not open automatically, when the vehicle is moving more than 3 km/h (2 mph).

⚠ WARNING

The chime will sound continuously if you drive over 3km/h (2mph) with the tailgate opened. Stop your vehicle immediately at a safe place and check if your tailgate is opened.

⚠ CAUTION

Do not operate the power tailgate more than 5 times continuously. It may damage the power tailgate system. If the spindle is strained

due to continuous operation, the chime will sound 3 times and the power tailgate will not operate. At this time, stop operating the tailgate and leave it for more than 1 minute.

* NOTICE

- The power tailgate can be operated when the engine is not running. However the power tailgate operation consumes large amounts of vehicle electric power. To prevent the battery from being discharged, do not operate it excessively e.g.: more than approximately 10 times repeatedly.
- To prevent the battery from being discharged, do not leave the power tailgate in the open position for a long time.
- Do not modify or repair any part of the power tailgate by yourself. Kia recommends to visit an authorised Kia dealer/service partner.
- When jacking up the vehicle to change a tyre or repair the vehicle, do not operate the power tailgate. This could cause the power tailgate to operate improperly.
- In cold and wet climates, the power tailgate may not work properly due to freezing conditions.

Automatic reversal

During power opening and closing if the power tailgate is blocked by an object or part of the body, the power tailgate will detect the resistance.

- If the resistance is detected whilst opening the tailgate, it will stop and move in the opposite direction.
- If the resistance is detected whilst closing the tailgate, it will stop and move in the opposite direction.

However, if the resistance is weak such as from an object that is thin or soft, or the tailgate is near the latched position, the automatic stop and reversal may not detect the resistance. If the automatic reversal feature operates continuously more than twice during opening or closing operation, the power tailgate may stop at that position. At this time, check the surroundings and operate the tailgate automatically again.

⚠ WARNING

- Never intentionally place any object or part of your body in the path of the power tailgate to make sure the automatic reversal operates.

- Never operate power tailgate attached with any heavy objects (e.g. bicycles). It could damage the power tailgate.

How to reset the power tailgate

If the battery has been discharged or disconnected, or if the related fuse has been replaced or disconnected, for the power tailgate to operate normally, reset the power tailgate as follow:

1. Make sure the gear is shifted to P (Park) position.
2. Whilst Pressing the tailgate close button, press the tailgate handle switch for more than 3 seconds. (the buzzer will sound)
3. Close the tailgate manually.

If the power tailgate does not work properly after the above procedure, have the system checked by a professional workshop. Kia recommends to visit an authorised Kia dealer/service partner.

* NOTICE

If the power tailgate does not operate normally, check again if the gear is in the correct position.

Power tailgate speed adjustment

To adjust the power tailgate speed, go to 'User Settings → Door → Power tailgate speed → Normal/Fast' within the instrument cluster settings of the infotainment system.

- If power tailgate function turns off or tailgate is not fully closed, you can not adjust the power tailgate speed.
- Initial speed of Power tailgate is set as "Fast".

For more details, refer to "LCD display" on page 5-80.

Power tailgate opening height (if equipped)

The driver may set the height of a fully opened tailgate by following the below instruction.



The tailgate opening height can be adjusted within the instrument cluster settings or the infotainment system.

To adjust the power tailgate opening height, go to 'User Settings → Door → Power Tailgate Opening Height → Level 1/Level 2/Level 3/ Full Open/User Height Setting' to adjust the vehicle's tailgate height.

If your vehicle is equipped with an infotainment system, you can learn how to setup on the website via QR code in the infotainment quick reference guide.

Power tailgate opening height user setting (if equipped)

The driver may set the height of a fully opened tailgate by following the below instruction.



The tailgate opening height can be adjusted within the infotainment system.

Go to "User Settings" → "Door" → "Power Tailgate Opening Height" → "User Height Setting" in order to adjust your vehicle's tailgate height.

1. Adjust the tailgate to the preferred height.
2. Press the power tailgate close button for approximately 3 seconds
3. After the beep sound appears, the setup is finished

Smart Tailgate with Auto Open (if equipped)

On a vehicle equipped with a smart key, the tailgate can be opened using the Smart Tailgate with Auto Open system.



How to use the Smart Tailgate with Auto Open

The tailgate can be opened with no-touch activation satisfying all the conditions below.

- After 15 seconds when all doors are closed and locked
- Positioned in the detecting area for more than 3 seconds.

* NOTICE

The Smart Tailgate with Auto Open does not operate when:

- The smart key is detected within 15 seconds after the doors are closed and locked, and is continuously detected.
- The smart key is detected within 15 seconds after the doors are closed and locked, and 1.5 m from the front door handles. (for vehicles equipped with Welcome Light)
- A door is not locked or closed.
- The smart key is in the vehicle.

1. Setting

To activate the Smart Tailgate with Auto Open, go to User Settings Mode and select Smart Tailgate on the LCD display. For more details, refer to "LCD display" on page 5-80.

2. Detect and Alert

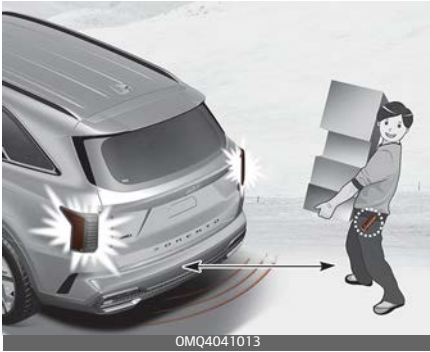

If you are positioned in the detecting area (50 ~ 100 cm [20 ~ 40 inches] behind the vehicle) carrying a smart key, the hazard warning lights will blink and chime will sound to alert you the smart key has been detected and the tailgate will open.

* NOTICE

Do not approach the detecting area if you do not want the tailgate to open. If you have unintentionally entered the detecting area and the hazard warning lights and chime starts to operate, leave the detecting area with the smart key. The tailgate will stay closed.

3. Automatic opening



The hazard warning lights will blink and chime will sound 6 times and then the tailgate will open.

⚠ WARNING

- Make sure you close the tailgate before driving your vehicle.
- Make sure there are no people or objects around the tailgate before opening or closing the tailgate.
- Make sure objects in the tailgate do not come out when opening the tailgate on a slope. It may cause serious injury.
- Make sure to deactivate the Smart Tailgate with Auto Open when washing your vehicle. Otherwise, the tailgate may open inadvertently.
- The key should be kept out of reach of children. Children may inadvertently open the Smart Tailgate with Auto Open whilst playing around the rear area of the vehicle.

How to deactivate the Smart Tailgate with Auto Open function using the smart key



1. Door lock
2. Door unlock
3. Tailgate open

If you press any button of the smart key during the Detect and Alert stage, the Smart Tailgate with Auto Open function will be deactivated.

Make sure to be aware of how to deactivate the Smart Tailgate with Auto Open function for emergency situations.

* NOTICE

- If you press the door unlock button (2), the Smart Tailgate with Auto Open function will be deactivated temporarily. But, if you do not open any door for 30 seconds, the Smart Tailgate with Auto Open function will be activated again.

- If you press the tailgate open button (3) for more than 1 second, the tailgate opens.
- If you press the door lock button (1) or tailgate open button (3) when the Smart Tailgate with Auto Open function is not in the Detect and Alert stage, the Smart Tailgate with Auto Open function will not be deactivated.
- In case you have deactivated the Smart Tailgate with Auto Open function by pressing the smart key button and opened a door, the Smart Tailgate with Auto Open function can be activated again by closing and locking all doors.

Detecting area



- The Smart Tailgate with Auto Open operates with a welcome alert if the smart key is detected within 50 ~ 100 cm from the tailgate.
- The alert stops at once if the smart key is positioned outside

the detecting area during the Detect and Alert stage.

*** NOTICE**

- The Smart Tailgate with Auto Open function will not work if any of the following occurs:
 - The smart key is close to a radio transmitter such as a radio station or an airport which can interfere with normal operation of the transmitter.
 - The smart key is near a mobile two way radio system or a mobile phone.
 - Another vehicle's smart key is being operated close to your vehicle.
 - The detecting range may decrease or increase when :
 - One side of the tyre is raised to replace a tyre or to inspect the vehicle.
 - The vehicle is slantingly parked on a slope or unpaved road, etc.
-

Windows

The doors of this vehicle are equipped with power windows that can be operated by a switch.

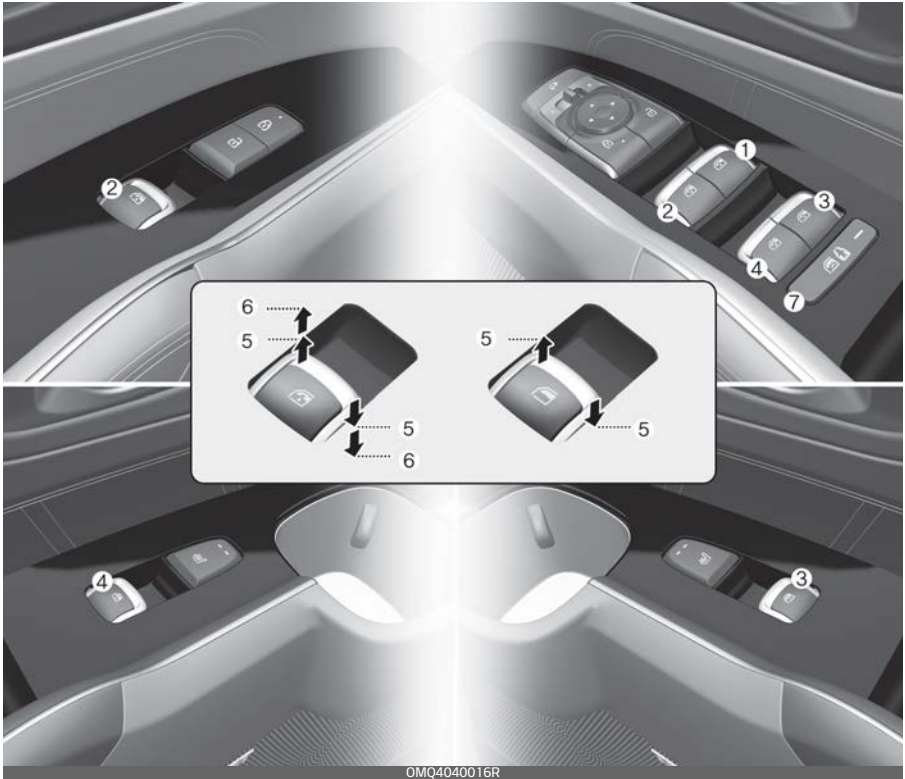

1. Driver's door power window switch
2. Front passenger's door power window switch
3. Rear door (right) power window switch
4. Rear door (left) power window switch
5. Window opening and closing
6. Automatic power window up/down (if equipped)
7. Power window lock switch

*** NOTICE**

In cold and wet climates, power windows may not work properly due to freezing conditions.

The ignition switch or ENGINE START/STOP button must be in the ON position for power windows to operate.

Each door has a power window switch that controls the door's window. The driver has a power window lock button which can block the operation of rear passenger windows. The power windows can be operated for approximately 3 minutes after ignition switch or ENGINE START/STOP button turned to the ACC or LOCK position. However, if the front doors are opened, the power windows cannot be operated even within the 3 minutes period.

The driver's door has a master power window switch that controls all the windows in the vehicle.

If the window cannot be closed because it is blocked by objects, remove the objects and close the window.

*** NOTICE**

Whilst driving with the rear windows down or with the sunroof (if equipped) in an open (or partially open position), your vehicle may demonstrate a wind buffeting or pulsation noise. This noise is a normal occurrence and can be reduced or eliminated by taking the following actions. If the noise occurs with one or both of the rear windows down, partially lower both front windows approximately one inch. If you experience the noise with the sunroof open, slightly reduce the size of the sunroof opening.

⚠ WARNING

Do not install any accessories in the area of windows. It may impact jam protection.

Window opening and closing

You can open and close windows using the power window switch.

Type A



OMQ4040444

To open or close a window, press down or pull up the front portion of the corresponding switch to the first detent position (5).

Type B - Auto up/down window (if equipped)



OMQ4040445

Pressing or pulling up the power window switch momentarily to the second detent position (6) completely lowers or raises the window

even when the switch is released. To stop the window at the desired position whilst the window is in operation, pull up or press down and release the switch.

To reset the power windows

If the power window does not operate normally, the automatic power window system must be reset as follows:

1. Turn the ignition switch or ENGINE START/STOP button to the ON position.
2. Close the window and continue pulling up the power window switch for at least 1 second after the window is completely closed.

Automatic reversal (if equipped)

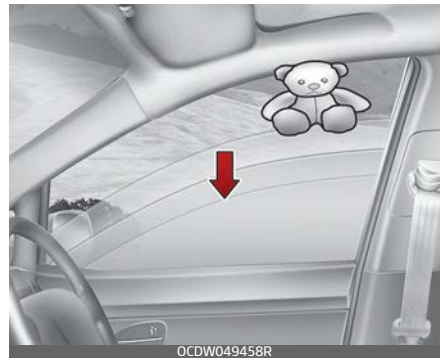

OCDW049458R

If the upward movement of the window is blocked by an object or part of the body, the window will detect the resistance and will stop upward movement. The window will then lower approximately 30 cm

(11.8 in) to allow the object to be cleared.

If the window detects the resistance whilst the power window switch is pulled up continuously, the window will stop upward movement then lower approximately 2.5 cm (1 inch).

And if the power window switch is pulled up continuously again within 5 seconds after the window is lowered by the automatic window reversal feature, the automatic window reversal will not operate.

* NOTICE

The automatic reverse feature for the window is only active when the "auto up" feature is used by fully pulling up the switch. The automatic reverse feature will not operate if the window is raised using the half-way position on the power window switch.

⚠ WARNING

Always check for obstructions before raising any window to avoid injuries or vehicle damage. If an object less than 4 mm (0.16 of an inch) in diameter is caught between the window glass and the upper window channel, the automatic reverse window may not detect the

resistance and will not stop and reverse direction.

⚠ WARNING

The automatic reverse feature is not activated whilst resetting power window system.

Make sure body parts or other objects are safely out of the way before closing the windows to avoid injuries or vehicle damage.

Power window lock button

The driver can disable the power window switches on the rear passengers' doors by pressing the power window lock button to the lock position (pressed).



When the power window lock button is pressed:

- The driver's master control can operate all passengers' power windows.

- The front passenger's control can operate the front passenger's power window.
- The rear passengers' control cannot operate the rear passenger's power window.
- * If the power window lock switch is operated (indicator turns on), rear passenger cannot open the rear door (if equipped with the Electronic Child Safety Lock System). For more details, refer to "Electronic child safety lock system (if equipped)" on page 5-23.

⚠ CAUTION

- To prevent possible damage to the power window system, do not open or close two windows or more at the same time. This will also ensure the longevity of the fuse.
- Never try to operate the main switch on the driver's door and the individual door window switch in opposite directions at the same time. If this is done, the window will stop and cannot be opened or closed.

⚠ WARNING

Windows

- NEVER leave the keys in your vehicle with unsupervised children, when the engine is running.
- NEVER leave any child unattended in the vehicle. Even very young children may inadvertently cause the vehicle to move, entangle themselves in the windows, or otherwise injure themselves or others.
- Always double check to make sure all arms, hands, head and other obstructions are safely out of the way before closing a window.
- Do not allow children play with the power windows. Keep the driver's door power window lock button in the LOCK position (pressed). SERIOUS INJURY can result from unintentional window operation by the child.
- Do not extend heads or any limbs outside the window whilst the vehicle is in motion.

**Remote window closing/opening
(Hybrid vehicle)**

Remote Key



Smart Key



When the vehicle is off, if the door lock button (1) is pressed for 3 sec-

onds or more, the door will be locked and the window will start to move up.

When the vehicle is off, if the door unlock button is pressed for 3 seconds or more, the door will be unlocked and the window will start to move down.

The window will go up as much as the button pressed and stops when the button is released.

* Remote window closing/opening requires the automatic power window up/down for all seats to be applied.

CAUTION

- If a car window is rolled up with the remote window close but the distance between the remote control and vehicle is changed, the window can stop rolling up. Make sure to operate this function in the vicinity close enough to a vehicle in sight.
- If a window is stuck by certain forces while rolling up, it stops working, but the other three windows will continue to roll up. Make sure that the emergency warning light blinks three times and the rest of windows are completely shut.

Bonnet

The bonnet serves as a cover for the engine compartment.

Open the bonnet if maintenance work needs to be performed in the engine compartment or if you need to look at the compartment.

Opening the bonnet

1. Pull the release lever to unlatch the bonnet. The bonnet should pop open slightly.

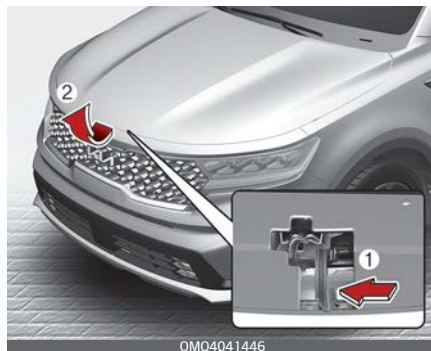

5

⚠ WARNING

Open the bonnet after turning off the engine on a flat surface, shifting the gear to the P (Park) position and setting the parking brake.

2. Go to the front of the vehicle, raise the bonnet slightly, push the secondary latch (1) to the left and lift the bonnet (2).

Bonnet open warning

The bonnet warning message will appear on the LCD display when bonnet is open.



The warning chime will operate when the vehicle is being driven at or above 3 km/h (2 mph) with the bonnet open.

Closing the bonnet



1. Before closing the bonnet, check the following:
 - All filler caps in the engine compartment must be correctly installed.
 - Gloves, rags or any other combustible material must be removed from the engine compartment.
2. Lower the bonnet until it is about 30 cm above the closed position and let it drop. Make sure that it locks into place.
3. Check that the bonnet has engaged properly.
 - If the bonnet can be raised slightly, it is not properly engaged.
 - Open it again and close it with a little more force.

⚠ WARNING

- Before closing the bonnet, ensure that all obstructions are removed from the bonnet opening. Closing the bonnet with an obstruction present in the bonnet opening may result in property damage or severe personal injury.
- Do not leave gloves, rags or any other combustible material in the engine compartment. Doing so may cause a heat-induced fire.

⚠ WARNING

- Always double check to be sure that the bonnet is firmly latched before driving away. If it is not latched, the bonnet could open whilst the vehicle is being driven, causing total loss of visibility, which might result in an accident.
- Do not move the vehicle with the bonnet raised. The view will be blocked and the bonnet could fall or be damaged.

Fuel filler door

The fuel filler door must be opened from inside the vehicle by pushing the fuel filler door button.

Opening the fuel filler door (Hybrid vehicle)

1. Turn the engine off.
2. Ensure the all doors are unlocked.
3. Press the rear centre edge of the fuel filler door.



4. Pull the fuel filler door (1) out to fully open.



5. To remove the fuel tank cap (2), turn it counterclockwise. You may hear a hissing noise as the pressure inside the tank equalises.
6. Place the cap on the fuel filler door.

* NOTICE

For hybrid vehicle, the fuel filler door will unlock when the driver's door is unlocked.

To unlock fuel filler door:

- Press the unlock button on your smart key.
- Press the central door unlock button on armrest trim of driver's door.
- Pull the driver's inside door handle outward.

The fuel filler door will lock when all doors are locked. To lock fuel filler door:

- Press the lock button on your smart key.
 - Press the central door lock button on armrest trim of driver's door.
- * All doors will automatically lock after the vehicle speed exceeds 15 km/h (9 mph). Fuel door is also locked when vehicle speed exceeds 15 km/h (9 mph).

*** NOTICE**

If the fuel filler door does not open because ice has formed around it, tap lightly or push on the door to break the ice and release the door. Do not pry on the door. If necessary, spray around the door with an approved de-icer fluid (do not use radiator anti-freeze) or move the vehicle to a warm place and allow the ice to melt.

Opening the fuel filler door (Plug-in hybrid vehicle)

1. Stop the engine. To open the fuel filler door, push the fuel filler door opener button.



2. Wait until the fuel tank is depressurised. The message is displayed when the fuel filler door unlocks after the fuel tank is depressurised.



3. The fuel door is unlocked when the message is displayed.



4. Press the rear centre edge of the fuel filler door.





OMQ4PH050362R

5. Pull open the fuel filler door (1). To remove the cap, turn the fuel filler cap (2) counterclockwise. Refuel as needed.



OMQ4040023

* NOTICE

- It may take up to 20 seconds to unlock fuel filler door.
- If the fuel filler door does not open because ice has formed around it, tap lightly or push on the door to break the ice and release the door.
- Do not pry on the door. If necessary, spray around the door with an approved de-icer fluid (do not

use radiator anti-freeze) or move the vehicle to a warm place and allow the ice to melt.

⚠ WARNING

Before refuelling, be sure to check what type of fuel is used for your vehicle. If you put diesel fuel into a petrol-powered vehicle or petrol into a diesel-powered vehicle, it may affect the fuel system and cause serious damage to the vehicle.

⚠ WARNING

- Add fuel into the fuel tank within 20 minutes after opening the fuel filler door. After 20 minutes, the fuel tank may shut off, causing fuel to overflow. In this case, repress the fuel filler door opening button.
- Do not leave the fuel filler door opened for an extended period of time. It may discharge the battery.
- Close the fuel filler door after fuelling the vehicle. If you start the vehicle with the fuel filler door opened, "Check fuel door" message illuminates on the LCD display.
- Avoid refuelling the vehicle whilst charging the (high-voltage) hybrid battery. It may cause a fire or an explosion due to static electricity.

Closing the fuel filler door

1. To install the cap, turn it clockwise until it "clicks". This indicates that the cap is securely tightened.
2. Close the fuel filler door by pressing the rear centre edge of fuel filler door.
3. When the fuel filler door is closed properly, it will lock approximately in 5 seconds.

* If the fuel door is opened again as soon as it is closed, the fuel door will not lock. Then, close the fuel door well again and it will lock approximately in 5 seconds.

Always check that the fuel cap is installed securely to prevent fuel spillage in the event of an accident.

WARNING

Petrol is highly flammable and explosive. Failure to follow these guidelines may result in **SERIOUS INJURY** or **DEATH**:

- Read and follow all warnings posted at the gas station.
- Before refuelling, note the location of the Emergency Petrol Shut-Off, if available, at the gas station.
- Before touching the fuel nozzle, you should eliminate the potential build-up of static electricity by touching a metal part of the vehicle, a safe distance away from the fuel filler neck, nozzle, or other gas source, with your bare hand.
- Do not use mobile phones whilst refuelling. Electric current and/or electronic interference from mobile phones can potentially ignite fuel vapours and cause a fire.
- Do not get back into a vehicle once you have begun refuelling. You can generate a build-up of static electricity by touching, rubbing or sliding against any item or fabric capable of producing static electricity. Static electricity discharge can ignite fuel vapours causing a fire. If you must re-enter the vehicle, you should once again eliminate potentially dangerous static electricity discharge by touching a metal part of the vehicle, away from the fuel filler neck, nozzle or other petrol source, with your bare hand.
- When refuelling, always shift the gear to the P (Park) position, set the parking brake, and place the ignition switch or ENGINE START/STOP button to the LOCK/OFF position.
- Sparks produced by electrical components related to the engine can ignite fuel vapours causing a fire.
- When using an approved portable fuel container, be sure to place the container on the ground prior to refuelling. Static electricity dis-

charge from the container can ignite fuel vapours causing a fire. Once refuelling has begun, contact between your bare hand and the vehicle should be maintained until the filling is complete.

- Use only approved portable plastic fuel containers designed to carry and store petrol.
- Do not use matches or a lighter and do not smoke or leave a lit cigarette in your vehicle whilst at a gas station, especially during refuelling.
- Do not over-fill or top-off your vehicle tank, which can cause petrol spillage.
- If a fire breaks out during refuelling, leave the vicinity of the vehicle, and immediately contact the manager of the gas station and then contact the local fire department. Follow any safety instructions they provide.
- If pressurised fuel sprays out, it can cover your clothes or skin and thus subject you to the risk of fire and burns. Always remove the fuel cap carefully and slowly. If the cap is venting fuel or if you hear a hissing sound, wait until the condition stops before completely removing the cap.
- Always check that the fuel cap is installed securely to prevent fuel spillage in the event of an accident.

* NOTICE

Make sure to refuel your vehicle according to the "Fuel requirements" on page 2-2.

* NOTICE

- Do not spill fuel on the exterior surfaces of the vehicle. Any type of fuel spilled on painted surfaces may damage the paint.
- If the fuel filler cap requires replacement, use only a genuine Kia cap or the equivalent specified for your vehicle. An incorrect fuel filler cap can result in a serious malfunction of the fuel system or emission control system.

⚠ WARNING

In case of using EV drive mode for a certain time without running engine, EMM (Engine Maintenance Mode) will automatically activate by the system to protect the fuel system and the engine.

Therefore, even though if it is possible to use EV drive mode with enough battery power, the engine may run by the system to protect fuel system and the engine.

If you leave the fuel without refuelling or using for over 6 months, the remained fuel in the fuel system may be deteriorated.

From this, corrosion or blocking problem may occur.

It is recommended using minimum 40 % of remained fuel at least every 6 months by selecting Hybrid (CS) mode and refuel the vehicle with new fuel.

Panorama sunroof (if equipped)

If your vehicle is equipped with a sunroof, you can slide or tilt your sunroof with the sunroof switch located on the overhead console.



The sunroof can only be operated when the ignition switch or Engine Start/Stop button is in the ON or START position.

The sunroof can be operated for approximately 3 minutes after the ignition switch or Engine Start/Stop button is in the ACC or LOCK/OFF position. However, if the front door is open, the sunroof cannot be operated even within the 3 minute period.

⚠ WARNING

- Never adjust the sunroof or sunshade whilst driving. This could result in loss of control and an accident that may cause injury, or property damage.
- Do not leave the engine running and the key in your vehicle with unsupervised children. Unattended children could operate the sunroof, which could result in serious injury.
- Do not sit on the top of the vehicle. It may cause injury or vehicle damage.

*** NOTICE**

- Do not operate sunroof when roof bars are installed on the vehicle or when there is luggage on the roof.

Power sunshade

Use the power sunshade to block direct sunlight coming through the sunroof glass.

- Push the sunroof switch rearward to the first detent position, the power sunshade automatically slides open.
- Push the sunroof switch forward to the first detent position, the power sunshade automatically closes. However, if the sunroof glass is open, the glass will close first.

To stop the power sunshade at any point, push the sunroof switch in any direction.

*** NOTICE**

Do not pull or push the power sunshade by hand as such action may damage the power sunshade or cause it to malfunction.

*** NOTICE**

Wrinkles formed on the power sunshade are normal due to material characteristic.

Tilt open/close



- Push the sunroof switch upward, the sunroof glass tilts open. However, if the power sunshade is close, the sunshade will open first.
- Push the sunroof switch upward or forward when the sunroof glass is tilt opened, the sunroof glass automatically closes.

To stop the sunroof movement at any point, push the sunroof switch in any direction.

Slide open/close



- Push the sunroof switch rearward to the first detent position, the sunroof glass opens. However, if the power sunshade is close, the power sunshade will open first. Push the sunroof switch forward to the first detent position, the sunroof glass closes. However, if the sunroof glass is close, the power sunshade will close.
- Push the sunroof switch forward or rearward to the second detent position, the power sunshade and sunroof glass operate automatically (auto slide feature). To stop the sunroof movement at any point, push the sunroof switch in any direction.

Automatic reversal

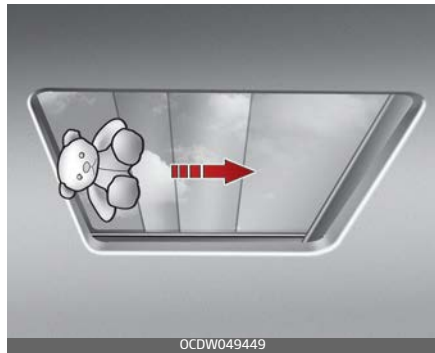

If the power sunshade or sunroof glass senses any obstacle whilst it is closing automatically, it will reverse direction then stop at a certain position.

The auto reverse function may not work if an object thin or soft is caught between the sliding power sunshade or sunroof glass and sunroof sash.

⚠ WARNING

- Make sure heads, hands, arms or any other body parts or objects are out of the way before operating the sunroof. Body parts or objects may get caught causing injuries or vehicle damage.
- Never deliberately use your body parts to test the automatic reversal function. The power sunshade or sunroof glass may reverse direction, but there is a risk of injury.

*** NOTICE**

- Do not continue to push the sunroof switch after the sunroof is fully opened, closed, or tilted. Damage to the sunroof motor could occur.
- Continuous operations such as slide open/close, tilt open/close, etc. may cause the motor or sunroof system to malfunction.
- Regularly remove any accumulated dust on the sunroof rail.
- Dust accumulated between the sunroof and roof panel can make noise. Open the sunroof and

remove dust regularly using a clean cloth.

- Do not try to open the sunroof when the temperature is below freezing or when the sunroof is covered with snow or ice. The sunroof may not work properly and may break if opened by force.
- Do not open or drive with the sunroof glass open immediately after rain or washing the vehicle. Water may wet the interior of the vehicle.
- Do not extend any luggage outside the sunroof whilst driving. Vehicle damage may occur if the vehicle suddenly stops.

⚠ WARNING

Do not extend your head, arms, body parts or objects outside the sunroof whilst driving. Injuries may occur if the vehicle suddenly stops.

Resetting the sunroof



In some circumstances resetting the sunroof operation may need to be performed. Some instances where resetting the sunroof may be required include:

- When the 12-volt battery is either disconnected or discharged
- When the sunroof fuse is replaced
- If the sunroof one-touch AUTO OPEN/CLOSE operation is not functioning properly

Sunroof resetting procedure:

1. It is recommended to perform the reset procedure with the vehicle engine running. Start the vehicle in P (Park).
2. Make sure the power sunshade and sunroof glass are in the fully closed position. If the power sunshade and sunroof glass are open, push the switch forward until the power sunshade and sunroof glass are fully closed.
3. Release the switch when the power sunshade and sunroof glass are fully closed.
4. Push the switch forward until the power sunshade and sunroof glass move slightly. Then release the switch.
5. Once again push and hold the sunroof switch forward until the power sunshade and sunroof glass slide open and close. Do not release the switch until the operation is completed.

If you release the switch during operation, start the procedure again from step 2.

* NOTICE

If the sunroof does not reset when the vehicle battery is disconnected or discharged, or the sunroof fuse is blown, the sunroof may not operate normally.

Sunroof open warning



If the driver turns off the engine when the sunroof is not fully closed, the warning chime will sound for several seconds and the sunroof open warning will appear on the cluster LCD display.

Close the sunroof securely when leaving your vehicle.

⚠ CAUTION

Make sure the sunroof is closed fully when leaving your vehicle. If the sunroof is left open, rain or snow may wet the interior of the vehicle. Also, leaving the sunroof open when the vehicle is unattended may invite theft.

Steering wheel

The steering wheel of this vehicle is equipped with the Electric Power Steering (EPS) system.

Electric power steering (EPS)

Power steering uses the motor to assist you in steering the vehicle.

If the engine is off or if the power steering system becomes inoperative, the vehicle may still be steered, but it will require increased steering effort.

The EPS is controlled by the power steering control unit which senses the steering wheel torque and vehicle speed to command the motor.

The steering effort becomes heavier as the vehicle's speed increases and becomes lighter as the vehicle's speed decreases for better control of the steering wheel.

Should you notice any change in the effort required to steer during normal vehicle operation, have the system checked by a professional workshop. Kia recommends to visit an authorised Kia dealer/service partner.

* NOTICE

The following symptoms may occur during normal vehicle operation:

- The EPS warning light does not illuminate.
- The steering effort is high immediately after turning the ignition switch or ENGINE START/STOP button on. This happens as the EPS system performs the diagnostics. When the diagnostics is completed, the steering effort will return to its normal condition.
- A click noise may be heard from the EPS relay after the ignition switch or ENGINE START/STOP button is turned to the ON or LOCK position.
- Motor noise may be heard when the vehicle is at a stop or at a low driving speed.
- When the abnormality is detected in the electric power steering system, a deadly accident prevention purposes, steering assist functions will be stopped. At this time, the instrument panel warning light turns on or blinks and the power to manipulate the steering will be off. Please check immediately after moving the vehicle to a safe zone.
- The steering effort increases if the steering wheel is rotated continuously when the vehicle is not in motion. However, after a few

minutes, it will return to its normal conditions.

- If the Electric Power Steering System does not operate normally, the warning light will illuminate or blink on the instrument cluster. The steering wheel may become difficult to control or operate abnormally. In this case, have the system inspected by a professional workshop. Kia recommends to visit an authorised Kia dealer/service partner.
- When you operate the steering wheel in low temperature, abnormal noise could occur. If temperature rises, the noise will disappear. This is a normal condition. When jump starting the vehicle after battery discharge, the steering wheel may not function properly. It is a temporary situation due to low battery voltage, and upon stable battery charging, the steering wheel will function normally again. Please move the steering wheel around to make sure the steering wheel is functioning properly before driving the vehicle.

Tilt & telescopic steering wheel

A tilt and telescopic steering wheel allows you to adjust the steering wheel before you drive. You can also raise it to give your legs more room when you exit and enter the vehicle.

The steering wheel should be positioned so that it is comfortable for you to drive, whilst permitting you to see the instrument panel warning lights and gauges.

⚠ WARNING

- Never adjust the angle and height of the steering wheel whilst driving. You may lose steering control and cause severe personal injury, death or accidents.
- After adjusting, push the steering wheel both up and down to be certain it is locked in position.

Adjusting steering wheel angle and height



1. To change the steering wheel angle, pull down the lock release lever (1).
2. Adjust the steering wheel to the desired angle (2) and height (3). Move the steering wheel, so it points toward your chest, not toward your face. Make sure you

can see the instrument panel warning lights and gauges. After adjusting, pull up the lock.

3. Pull up the lock-release lever to lock the steering wheel in place. Push the steering wheel both up and down to be certain it is locked in position.
4. Be sure to adjust the steering wheel to the desired position before driving.

*** NOTICE**

After adjustment, sometimes the lock-release lever may not lock the steering wheel.

It is not a malfunction. This occurs when two gears engage. In this case, adjust the steering wheel again and then lock the steering wheel.

Heated steering wheel (if equipped)

When the ignition switch is in the ON Position or the ENGINE START/STOP button is in the ON position, pressing the heated steering wheel button warms the steering wheel. The indicator on the button will illuminate.



To turn the heated steering wheel off, press the button once again. The indicator on the button will turn off.

- The heated steering wheel defaults to the OFF position whenever the ignition switch or ENGINE START/STOP button is in the ON position. However, if the Auto Comfort Control function is ON, the heated steering wheel will turn on and off depending on the outside temperature.
- Auto Comfort Control (for driver's seat) (if equipped)
The heated steering wheel automatically controls the steering wheel temperature depending on the ambient temperature when the engine is running. If the heated steering wheel switch is pushed, the heated steering wheel will have to be controlled manually.
To use this function, it must be activated from the Settings menu

in the infotainment system screen.

For more details, refer to the separately supplied manual with your vehicle.

* NOTICE

The heated steering wheel will turn off automatically approximately 30 minutes after the heated steering wheel is turned on.

⚠ CAUTION

- Do not install any type of grip cover for the steering wheel, it may impair the function of the heated steering wheel system.
- When cleaning the heated steering wheel, do not use an organic solvent such as paint thinner, benzene, alcohol and petrol. Doing so may damage the surface of the steering wheel.
- If the surface of the steering wheel is damaged by a sharp object, damage to the heated steering wheel components could occur.

⚠ WARNING

If the steering wheel becomes too warm, turn the system off. The heated steering wheel may cause burns even at low temperatures,

especially if used for long periods of time.

Horn

To sound the horn, press the area indicated by the horn symbol on your steering wheel (see illustration).



OMQ4041030

The horn will operate only when this area is pressed. Check the horn regularly to be sure it operates properly.

CAUTION

- Do not strike the horn severely to operate it, or hit it with your fist. Do not press on the horn with a sharp-pointed object.
- When cleaning the steering wheel, do not use an organic solvent such as thinner, benzene, alcohol and petrol. Doing so may damage the steering wheel.

Mirrors

This vehicle is equipped with inside and outside rear view mirrors to provide views of objects behind the vehicle.

Inside rear view mirror

Adjust the rear view mirror so that the centre view through the rear window is seen.

Make this adjustment before you start driving.

WARNING

Rear visibility

Do not place objects in the rear seat or cargo area which would interfere with your vision out the rear window.

WARNING

Do not adjust the rear view mirror whilst the vehicle is moving. This could result in loss of control, and an accident which could cause DEATH, SERIOUS INJURY, or property damage.

WARNING

Do not modify the inside mirror and don't install a wide mirror. It could result in injury, during an accident or deployment of the air bag.

Day/night rear view mirror (if equipped)

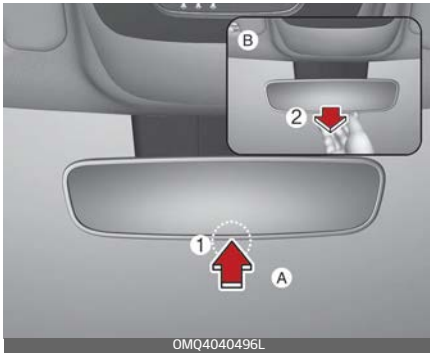

(A): Day, (B): Night

Make this adjustment before you start driving and whilst the day/night lever is in the day position (1).

Pull the day/night lever toward you (2) to reduce the glare from the headlights of the vehicles behind you during night driving.

Remember that you lose some rear view clarity in the night position.

Electric Chromic Mirror (ECM) (if equipped)

The electric rear view mirror automatically controls the glare from the headlights of the vehicles behind you in nighttime or low light driving conditions.



The sensor mounted in the mirror senses the light level around the vehicle, and automatically controls the headlight glare from the vehicles behind you.

When the engine is running, the glare is automatically controlled by the sensor mounted in the rear view mirror.

Outside rear view mirror

Your vehicle is equipped with both left-hand and right-hand outside rear view mirrors.

Be sure to adjust the mirror angles before driving.

The mirrors can be adjusted remotely with the control levers or

remote switch, depending on the type of mirror control installed. The mirror heads can be folded back to prevent damage during an automatic car wash or when passing through a narrow street.

⚠ WARNING

Rear view mirrors

- The outside rear view mirror is convex. Objects seen in the mirror are closer than they appear.
- Use your interior rear view mirror or direct observation to determine the actual distance of following vehicles when changing lanes.

⚠ CAUTION

Do not scrape ice off the mirror face; this may damage the surface of the glass. If ice should restrict the movement of the mirror, do not force the mirror for adjustment. To remove ice, use a deicer spray, or a sponge or soft cloth with warm water.

⚠ CAUTION

If the mirror is jammed with ice, do not adjust the mirror by force. Use an approved spray de-icer (not radiator antifreeze) to release the frozen mechanism or move the vehicle

to a warm place and allow the ice to melt.

⚠ WARNING

Do not adjust or fold the outside rear view mirrors whilst the vehicle is moving. This could result in loss of control, and an accident which could cause DEATH, SERIOUS INJURY, or property damage.

Adjusting the outside rear view mirrors

The electric remote control mirror switch allows you to adjust the position of the left and right outside rear view mirrors.



OMQ4040447R

Adjusting the rear view mirrors:

1. Move the R or L switch (1) to select the right side mirror or the left side mirror.
2. Press a corresponding point on the mirror adjustment control (2) to position the selected mirror up, down, left or right.

⚠ CAUTION

- The mirrors stop moving when they reach the maximum adjusting angles, but the motor continues to operate whilst the switch is pressed. Do not press the switch longer than necessary, the motor may be damaged.
- Do not attempt to adjust the outside rear view mirror by hand. Doing so may damage the parts.

Folding the outside rear view mirror***Manual type (if equipped)***

To fold the outside rearview mirror, grasp the housing of the mirror and then fold it toward the rear of the vehicle.

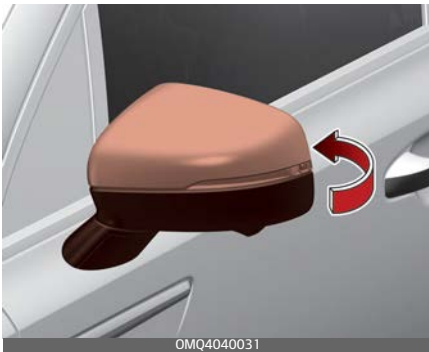
***Electric type (if equipped)***

The outside rear view mirror can be folded or unfolded by pressing the switch when the ignition switch or ENGINE START/STOP button is in the ON position as below.



- To fold the outside rear view mirror depress the button.
- To unfold it, depress the button again.

⚠ CAUTION

The electric type outside rear view mirror operates even though the ignition switch or ENGINE START/STOP button is in the LOCK or OFF position. However, to prevent unnecessary battery discharge, do not adjust the mirrors longer than necessary whilst the engine is not running.

⚠ CAUTION

In case it is an electric type outside rear view mirror, don't fold it by hand. It could cause motor failure.

Automatic adjustment of rearview mirrors in reverse (Auto reverse) (if equipped)

When you shift the gear to the R (Reverse) position, the outside rearview mirror(s) will rotate downwards to aid with driving in reverse.



The position of the outside rearview mirror switch (1) determines whether or not the mirrors will move:

Left/Right: When either the L (Left) or R (Right) switch is selected, both outside rearview mirrors will move.

Neutral: When neither switch is selected, the outside rearview mirrors will not move.

The outside rearview mirrors will automatically revert to their original positions if any of the following occur:

- The ignition switch or ENGINE START/STOP button is placed to either the LOCK/OFF position or the ACC position.
- The gear is shifted to any position except R (Reverse).
- The remote control outside rearview mirror switch is not selected.

Auto reverse user settings

If you cannot secure enough visibility with the angles provided as factory default conditions, you can readjust and store the angles of outside rearview mirrors.

The factory default angles of the right and left rearview mirrors might be set differently to improve visibility.

1. Set the shift dial to P (Parking).
Make sure that the vehicle is stopped and the mirrors are not working.
2. Position the lever to L (left) or R (right) depending on the mirror that you want to adjust.
3. Step on the brake pedal and turn the shift dial to R (Reverse).
4. When the downward movement of the rearview mirror is finished, adjust the mirror to the desired angle by pressing the switches, ▼, ▲, ◀, ▶.

5. If you change the shift dial to a position other than R (Reverse), or change the rearview mirror selector lever to the neutral position, and the automatic return of the mirror is finished, the adjusted angle will be automatically saved.
 6. You can adjust the rearview mirror on the other side by following the same procedures (1-5).
5. It is initialised when the shift dial is changed to a position other than R (Reverse), or the rearview mirror selector lever is changed to the neutral position. (Initialised position will be applied from next operation)
 6. You can initialise settings for the mirror on the other side by following the same procedures (1-5).

How to initialise auto reverse user settings

If you want to change the automatic control function of rearview mirrors to factory-default conditions, follow the steps below.

1. Position the shift dial to P (Park). Make sure that the vehicle is stopped and the mirror is not working.
2. Choose the mirror to be adjusted by positioning the lever to L (left) or R (right).
3. Step on the brake pedal and turn the shift dial to R (Reverse).
4. When the downward movement of the rearview mirror is finished, press the switch ▲ to locate the mirror in the position higher than before (P, N or D).
(Adjust the mirror in the higher position compared to its position in the driving mode)

⚠ CAUTION

We recommend following the procedures in an orderly manner to change or initialise the auto reversing user settings.

If you move to the next step before completing the previous one, the changed angle may not be changed or initialization may not work properly

Instrument cluster

Conventional cluster (Type A)

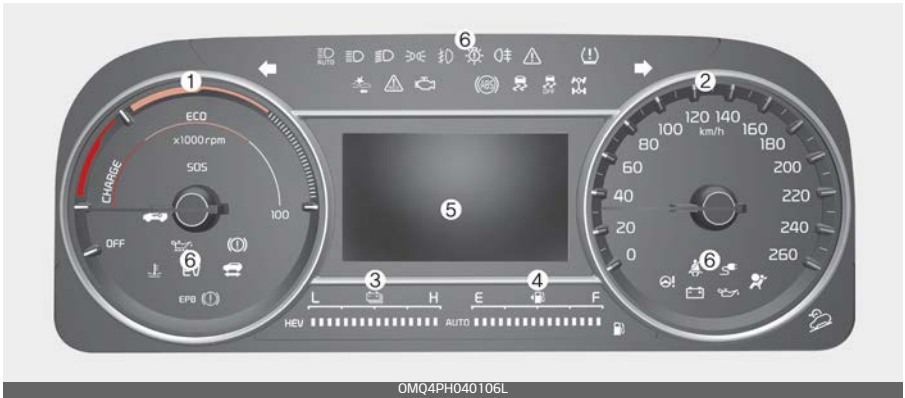

Full LCD cluster (Type B)

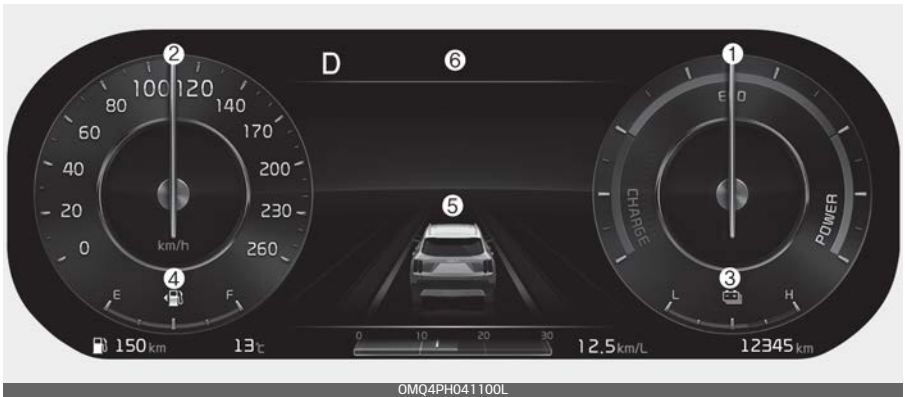

* The actual cluster in the vehicle may differ from the illustration.

1. Power gauge
2. Speedometer
3. Hybrid battery SOC gauge
4. Fuel gauge
5. LCD display (including Trip computer)
6. Warning and indicator lights

Full LCD cluster (if equipped)

The full LCD type cluster provides two themes.

Type A

Type A is the basic theme of the full LCD type cluster and provides different graphic styles depending on drive mode.

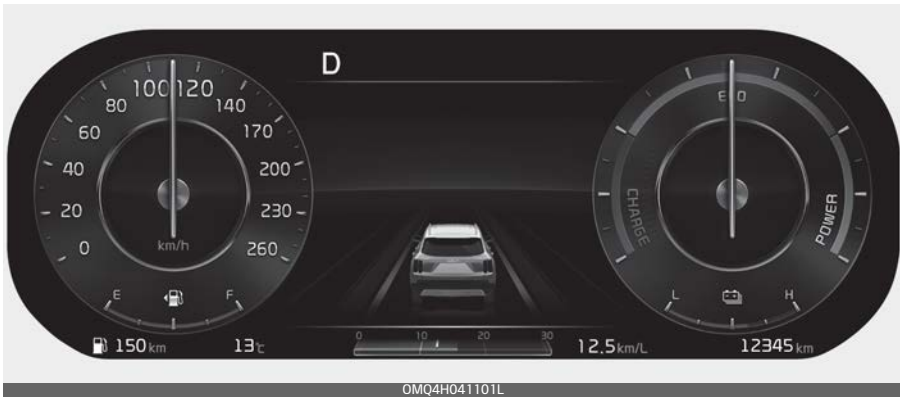

Type B (Dynamic)

Type B is set by the user and provides digital display. The background screen changes according to the weather and time.

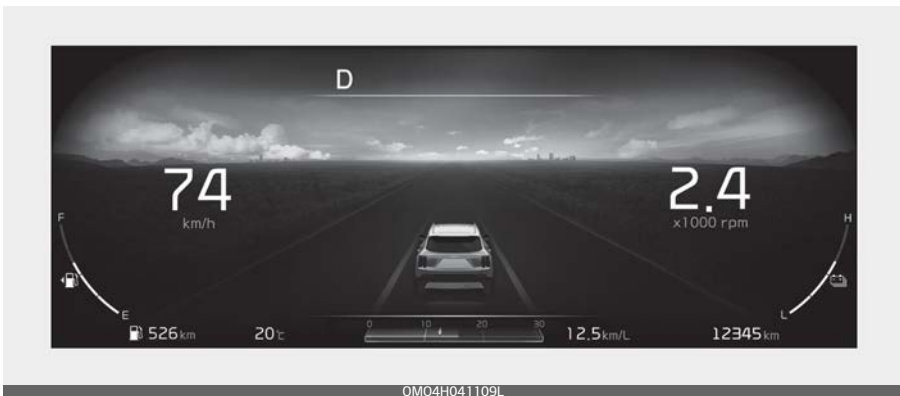

- Weather: sunny, cloudy, rainy, or snowy (4 types)
- Time: night, day, sunrise and sunset (4 types)

You can change the theme by selecting "Vehicle → Instrument Cluster Setting → Theme Selection" on the menu.

CAUTION

The information is displayed after getting information from a weather information provider via GPS.

Depending on conditions of GPS reception, the information may be different from the current weather in your area.

If no information is received via GPS (e.g., not subscribed to UVO service), the weather and time will be displayed as 'sunny' and 'night' on the cluster.

Gauges

The gauges display various information such as the speed of the vehicle, and so on.

Speedometer

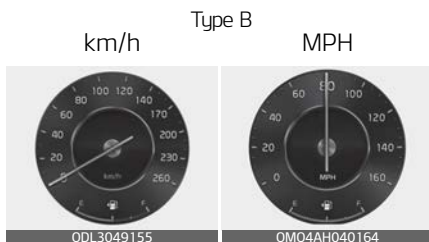

The speedometer indicates the speed of the vehicle and is calibrated in kilometres per hour (km/h) and miles per hour (mph).

Power gauge



The hybrid system gauge indicates whether the current driving condition is fuel efficient or not.

- **CHARGE:** Shows that the energy made by the vehicle is being converted to electrical energy. (Regenerated energy)

- ECO:
Shows that the vehicle is being driven in an Eco-friendly manner.
- POWER:
Shows that the vehicle is exceeding the Eco-friendly range.

*** NOTICE**

According to the hybrid system gauge area, the "EV" indicator comes on or off.

- "EV" indicator ON : Vehicle is driven using the electric motor or the petrol engine is stopped.
- "EV" indicator OFF : Vehicle is driven using the petrol engine.

Hybrid battery SOC (State of Charge) gauge

Type A

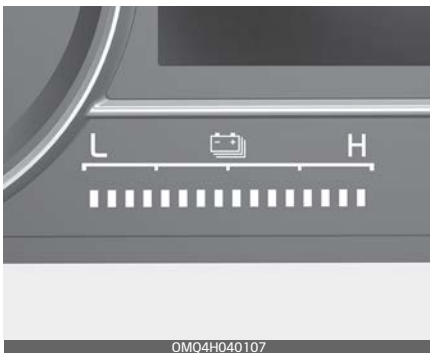

Type B

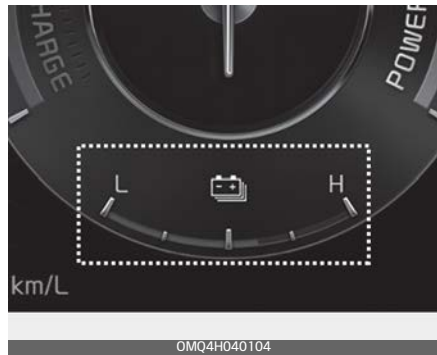

This gauge indicates the remaining hybrid battery power. If the SOC is near the "L (Low)" level, the vehicle automatically operates the engine to charge the battery.

However, if the Service Indicator (HEV) and Malfunction Indicator Lamp (MIL) (ENGINE) turn on when the SOC gauge is near the "L (Low)" level, we recommend to visit an authorised Kia dealer/service partner.

*** NOTICE**

Never try to start the vehicle if the fuel tank is empty. In this condition, the engine cannot charge the high voltage battery of the hybrid system. If you try to start the vehicle when the fuel is empty, the high voltage battery will become discharged and be damaged.

**Plug-in hybrid mode indicator
(Plug-in hybrid vehicle)**

- CD (Charge Depleting, Electric) mode: The high-voltage (hybrid) battery is used to drive the vehicle.

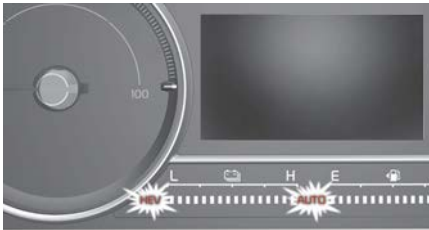

OMQ4PH050353L

- AUTO mode: The AUTO mode will be automatically selected from either from Electric (CD) mode or Hybrid (CS) mode by the system according to the driving condition.



OMQ4PHQ010045L

- CS (Charge Sustaining, Hybrid) mode: The high-voltage (hybrid) battery and petrol engine is used to drive the vehicle.



OMQ4PHQ010046L



OMQ4PH050364L

OMQ4PH050360L

OMQ4PH050366L

A corresponding message is displayed to indicate the selected mode.

Fuel gauge

Type A

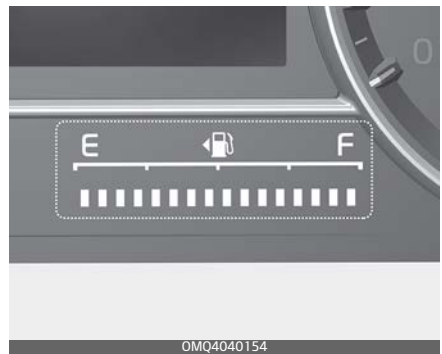

OMQ4040154

Type B



This gauge indicates the approximate amount of fuel remaining in the fuel tank.

*** NOTICE**

- The fuel tank capacity is given in "Recommended lubricants and capacities" on page 9-9.
- The fuel gauge is supplemented by a low fuel warning light, which will illuminate when the fuel tank is nearly empty.
- On inclines or curves, the fuel gauge pointer may fluctuate or the low fuel warning light may come on earlier than usual due to the movement of fuel in the tank.

⚠ WARNING

Fuel gauge

Running out of fuel can expose vehicle occupants to danger.

You must stop and obtain additional fuel as soon as possible after the

warning light comes on or when the gauge indicator comes close to the "E" level.

⚠ CAUTION

Avoid driving with a extremely low fuel level. Running out of fuel could cause the engine to misfire damaging the catalytic converter.

Odometer

Type A



OMQ4040113

Type B



OMQ4040155

The odometer Indicates the total distance that the vehicle has been driven and should be used to determine when periodic maintenance should be performed.

- Odometer range: 0 ~ 1,599,999 km or 999,999 miles.

Distance to empty

Type A



Type B



- If the estimated distance is below 1 km (1 mi.), the trip computer will display "---" as distance to empty.
- If the level of the remaining fuel is more than three-quarters, more than 3 litres of fuel must be refilled for the fuel gauge to change. In other cases, more than 6 litres of fuel must be refilled for the vehicle to change the fuel gauge.

*** NOTICE**

- If the vehicle is not on level ground or the battery power has been interrupted, the distance to empty function may not operate correctly.
- The distance to empty may differ from the actual driving distance as it is an estimate of the available driving distance.
- The trip computer may not register additional fuel if less than 6 litres (1.6 gallons) of fuel are added to the vehicle.
- The fuel economy and distance to empty may vary significantly based on driving conditions, driving habits, and condition of the vehicle.

- The distance to empty is the estimated distance the vehicle can be driven with the remaining fuel.
 - Distance range: 1 ~ 9,999 km or 1 ~ 9,999 mi.



Outside temperature gauge

Type A



Type B



This gauge indicates the current outside air temperatures by 1°C (1°F).

- Temperature range: -40°C ~ 60°C (-40°F ~ 140°F)

The outside temperature on the display may not change immediately like a general thermometer to prevent the driver from being inattentive.

To change the temperature unit (from °C to °F or from °F to °C)

The temperature unit can be changed by using the "User Settings" mode of the LCD Display.

* For more details, refer to "LCD display" on page 5-80.

Transmission shift indicator

Transmission shift indicator displays gear information depending on your vehicle's transmission type.

Automatic transmission shift indicator

Type A

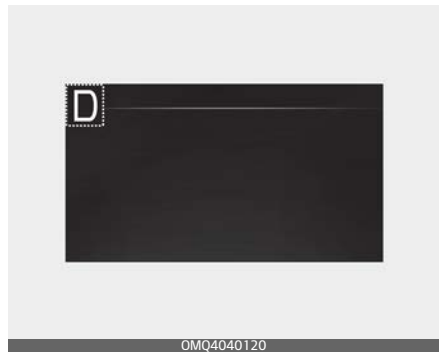

Type B

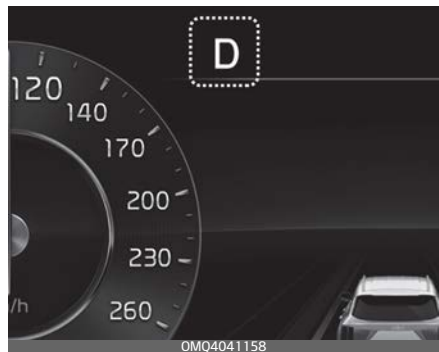

This indicator displays which automatic transmission gear is selected.

- Park: P
- Reverse: R
- Neutral: N
- Drive: D

Manual shift mode

- Shifting up: ▲2, ▲3, ▲4, ▲5, ▲6
- Shifting down: ▼1, ▼2, ▼3, ▼4, ▼5

Automatic transmission shift indicator in manual shift mode

In the Manual shift mode, this indicator informs which gear is desired whilst driving to save fuel.

Type A



Type B



- Shifting up: ▲2, ▲3, ▲4, ▲5, ▲6
- Shifting down: ▼1, ▼2, ▼3, ▼4, ▼5

For example

- ▲3: Indicates that shifting up to the 3rd gear is desired (currently the shift dial SBW is in the 2nd or 1st gear).
- ▼3: Indicates that shifting down to the 3rd gear is desired (currently the shift dial SBW is in the 4th, 5th or 6th gear).

When the system is not working properly, the indicator is not displayed.

Shift indicator pop-up

The pop-up that indicates the current gear position is displayed in the cluster for about 2 seconds when shifting into other positions (P/R/N/D).



The shift indicator pop-up function can be activated or deactivated from the User Settings mode in the cluster LCD display.

LCD display

The LCD display modes can be changed by using the control buttons.

LCD display control







1. : MODE button for changing modes
2. : MOVE switch for changing items
3. OK: SELECT/RESET button for setting or resetting the selected item





LCD display modes

The LCD display provides 5 modes. You can switch modes by pressing the Mode button.

Type A

Mode					
	 Trip Computer	 Driving Assist	 Turn By Turn (TBT)*	 User Settings	 Information / Marster warning
◇ Up/ Down	Range*1	Lane Keeping Assist* Smart Cruise Control* Navigation based Smart Cruise Control* Lane Following Assist Highway Driving Assist*	Route Guidance	Head-up display*	Intelligent Speed Limit Assist*
	Fuel Economy	Driver Attention Warning*	Destination Info	Driver Assistance	Tire Pressure Monitoring System*
	Accumulated Info			Door	Driving Force Distribution* The Master Warning mode displays warning messages related to the vehicle when one or more systems is not operating normally.
	Drive Info			Lights	
	Driving Style*			Sound	
	Energy Flow			Convenience	
				Service Interval	
				Theme Selection	
				Other	
				Eco Vehicle	
	Language				
	Default				

Type B

 Mode			
	 Trip Computer	 Driving Assist	 Turn by Turn (TBT)
 Up/Down	Range ^{*1}	Lane Keeping Assist* Smart Cruise Control* Navigation based Smart Cruise Control* Lane Following Assist Highway Driving Assist*	Route Guidance
	Energy Flow		Destination Info
	Drive info		
	After Refuel*		
	Accumulated Info		
	Digital Speedometer		
	Driving Style*		
	Tire Pressure Monitoring System*		
	Coolant Temperature		
	Intelligent Speed Limit System*		
	Driving Force Distribution*		

The information provided may differ depending on which functions are applicable to your vehicle.

* : if equipped

*1: For Plug-in Hybrid vehicle

Trip computer mode



The trip computer mode displays information related to vehicle driving parameters including fuel economy, tripmeter information and vehicle speed.

* For more details, refer to "Trip information (trip computer)" on page 5-92 and "Hybrid system overview" on page 1-2.

Turn By Turn (TBT) mode



This mode displays the state of the navigation.

Driving Assist mode



This mode displays the state of:

- Lane Safety system (if equipped)
- Smart Cruise Control (if equipped)
- Driver Attention Warning (if equipped)
- Tyre pressure

* For more details, refer to each system information in "Hybrid system overview" on page 1-2.

Tyre pressure status

This mode displays information related to Tyre Pressure.

* For more details, refer to "Tyre Pressure Monitoring System (TPMS) (if equipped)" on page 7-10.

Master warning mode



This warning light informs the driver the following situations.

- LED headlamp malfunction
- Lamp malfunction
- High Beam Assist malfunction (if equipped)

At this time, a Master Warning icon (⚠) will appear beside the User Settings icon (⚙), on the LCD display. If the warning situation is solved, the master warning light will be turned off and the Master Warning icon will disappear.

User settings mode



In this mode, you can change the settings of the instrument cluster, doors, lamps, etc.

1. Head-up display
2. Driver Assistance
3. Drive/Terrain mode
4. Eco vehicle
5. Cluster
6. Climate
7. Seat
8. Lights
9. Door
10. Convenience
11. Default

The information provided may differ depending on which functions are applicable to your vehicle.

1. Head-Up Display (if equipped)

Items	Explanation
Enable Head-up Display	If this item is checked, Head-Up Display will be activated.
Height	Adjust the height (1~20) of the HUD image on the HUD screen.
Rotation	Adjust the degree (-5~+5) of the HUD rotation.
Brightness	Adjust the intensity (1~20) of the HUD brightness.
Contents Selection	To select the content information on the HUD screen.

2. Driver Assistance (if equipped)

Items	Explanation
Driving Convenience	To adjust Highway Driving Assist For more details, refer to the "Highway Driving Assist (HDA) (if equipped)" on page 6-173
Driver Attention Warning	<ul style="list-style-type: none"> • Leading Vehicle Departure Alert To select the function. • Inattentive Driving Warning To select the function. * For more details, refer to "Driver Attention Warning (DAW) (if equipped)" on page 6-128.
Speed Limit Warning	<ul style="list-style-type: none"> • Speed Limit Offset To select the Warning time • Speed Limit Assist/Speed Assist Warning/Off To select the functions. * For more details, refer to "Intelligent Speed Limit Assist (ISLA) (if equipped)" on page 5-164.
Warning Timing	<ul style="list-style-type: none"> • Normal/Late To select the Warning time
Warning Volume	<ul style="list-style-type: none"> • High/Medium/Low/Off To select the Warning volume
Haptic Warning	If this item is checked, the Haptic Warning will be activated.

Items	Explanation
Forward Safety	To adjust Forward Collision-Avoidance Assist. <ul style="list-style-type: none"> • Active Assist/Warning Only/Off To select the functions. <p>* For more details, refer to "Forward Collision-Avoidance Assist (FCA) (Front view camera only) (if equipped)" on page 6-62 or "Forward Collision-Avoidance Assist (FCA) (Sensor fusion) (if equipped)" on page 6-75.</p>
Lane Safety	To adjust Lane Keeping Assist. <ul style="list-style-type: none"> • Assist/Warning Only/Off To select the functions. <p>* For more details, refer to "Lane Keeping Assist (LKA)" on page 6-91.</p>
Blind-spot Safety	To activate or deactivate Blind-Spot View. <ul style="list-style-type: none"> • Blind-spot View To activate or deactivate Safe Exit Warning. <ul style="list-style-type: none"> • Safe Exit Warning <p>* For more details, refer to "Safe Exit Warning (SEW) (if equipped)" on page 6-114.</p> To activate or deactivate Safe Exit Assist. <ul style="list-style-type: none"> • Safe Exit Assist <p>* For more details, refer to "Safe Exit Assist (SEA) (if equipped)" on page 6-113.</p> <ul style="list-style-type: none"> • Active Assist/Warning Only/Off <p>* For more details, refer to "Blind-Spot Collision-Avoidance Assist (BCA)" on page 6-97.</p>
Parking Safety	To activate or deactivate Surround View Monitor. <ul style="list-style-type: none"> • Surround View Monitor Auto Activation <p>* For more details, refer to "Surround View Monitor (SVM) (if equipped)" on page 5-124.</p> To activate or deactivate Parking Distance Warning. <ul style="list-style-type: none"> • Parking Distance Warning Auto Activation <p>* For more details, refer to "Forward/Reverse Parking Distance Warning (PDW) (if equipped)" on page 5-132.</p> To activate or deactivate Rear Cross-Traffic Safety. <ul style="list-style-type: none"> • Rear Cross-traffic Safety • Rear Active Assist/Rear Warning Only/off <p>* For more details, refer to "Rear Cross-Traffic Collision-Avoidance Assist (RCCA) (if equipped)" on page 6-173.</p>

* The information provided may differ depending on which systems are applicable to your vehicle.

3. Door

Items	Explanation
Auto Lock	<ul style="list-style-type: none"> • Enable On Speed: All doors will be automatically locked when the vehicle speed exceeds 15 km/h (9.3 mph) • Enable On Shift: All doors will be automatically locked if the vehicle is shifted from the P (Park) position to the R (Reverse), N (Neutral), or D (Drive) position. (With the Engine ON, it is activated.) • Off: The auto door unlock operation will be cancelled. <p>* If the setting is changed whilst the vehicle is in motion, the changed setting may not immediately operate.</p>
Auto Unlock	<ul style="list-style-type: none"> • On Vehicle Off: All doors will be automatically unlocked when the ignition key is removed from the ignition switch or the ENGINE START/STOP button is set to the OFF position. • On Shift to P: All doors will be automatically unlocked if the gear is shifted to the P (Park) position. (With the Engine ON, it is activated.) • Off: The auto door unlock operation will be cancelled. <p>* If the setting is changed whilst the vehicle is in motion, the changed setting may not immediately operate.</p>
Power Tailgate	<p>To activate or deactivate power tailgate.</p> <p>* For more details, refer to "Power tailgate (if equipped)" on page 5-32.</p>
Power Tailgate Speed	<p>To adjust the power tailgate speed.</p> <p>* For more details, refer to "Power tailgate speed adjustment" on page 5-37.</p>
Power Tailgate Opening Height	<p>To adjust the power tailgate height.</p> <p>* For more details, refer to "Power tailgate opening height user setting (if equipped)" on page 5-38.</p>
Smart Tailgate	<p>To activate or deactivate the Smart Tailgate with Auto Open.</p> <p>* For more details, refer to "Smart Tailgate with Auto Open (if equipped)" on page 5-39.</p>

* The information provided may differ depending on which systems are applicable to your vehicle.

4. Lights

Items	Explanation
Illumination	To adjust the instrument cluster illumination.
One Touch Turn Signal	<ul style="list-style-type: none"> • Off: The one touch turn signal function will be deactivated. • 3, 5, 7 flashes: The turn signal indicator will blink 3, 5, or 7 times when the turn signal lever is moved slightly. * For more details, refer to "Lighting" on page 5-138.
Ambient Light	Settings of the ambient light.
Ambient Light Colour	To select the Colour of ambient light.
Headlight Delay	If this item is checked, the head lamp delay function will be activated.
High Beam Assist	If this item is checked, High Beam Assist will be activated.

* The information provided may differ depending on which functions are applicable to your vehicle.

5. Sound

Items	Explanation
Welcome Sound	If this item is checked, the welcome sound function will be activated.

* The information provided may differ depending on which functions are applicable to your vehicle.

6. Convenience

Items	Explanation
Seat Easy Access	<ul style="list-style-type: none"> Off/Normal/Extended To select the seat movement.
Rear Occupant Alert	If this item is checked, the Rear Occupant Alert (ROA) display will be activated. * For more details, refer to "Rear Occupant Alert (ROA) System (if equipped)" on page 5-25.
Welcome Mirror/light	<ul style="list-style-type: none"> On Door Unlock/on Driver Approach To select the welcome mirror/light function.
Wireless Charging System	If this item is checked, the wireless charging function will be activated.
Wiper/Lights Display	If this item is checked, the wiper/lights display will be activated.
Auto Rear Wiper (in R)	If this item is checked, the auto rear wiper will be activated.
Icy Road Warning	If this item is checked, the icy road warning will be activated.

* The information provided may differ depending on which functions are applicable to your vehicle.

7. Service interval

Items	Explanation
Enable Service Interval	If this item is checked, the Service Interval function will be activated.
Adjust Interval	If the service interval menu is activated, you may adjust the time and distance.
Reset	To reset the service interval function.

If the service interval is activated and the time and distance is adjusted, messages are displayed in the following situations each time the vehicle is turned on.

- Service in: Displayed to inform the driver the remaining mileage and days to service.
- Service required: Displayed when the mileage and days to service has been reached or passed.

If any of the following conditions occur, the mileage and number of days to service may be incorrect.

- The battery cable is disconnected.
- The battery is discharged.

8. Theme Selection

Items	Explanation
Theme Selection	You can select the theme in the User Setting mode.

9. Other

Items	Explanation
Fuel Economy Reset	<ul style="list-style-type: none"> • Off: The average fuel economy will not reset. • After ignition / After refuelling: The average fuel economy will reset automatically after ignition/refuelling.
Speedometer Unit	<ul style="list-style-type: none"> • km/h or mph To select the Speedometer unit.
Fuel Economy Unit	<ul style="list-style-type: none"> • Km/L, L/100Km To select the Fuel economy unit. For more details, refer to "Trip information (trip computer)" on page 5-92.

Items	Explanation
Temperature Unit	<ul style="list-style-type: none"> • °C/°F To select the Temperature unit.
Tyre Pressure Unit	<ul style="list-style-type: none"> • psi, kPa, bar To select the Tyre Pressure Unit

* The information provided may differ depending on which functions are applicable to your vehicle.

10. Eco vehicle

Items	Explanation
Coasting Guidance	<ul style="list-style-type: none"> • Coasting Guidance To activate or deactivate Coasting Guidance. <ul style="list-style-type: none"> • Sound On/Sound Off To adjust coasting guidance notification volume. <p>* For more details, refer to "Coasting guide (if equipped)" on page 5-101.</p>
Start Coasting	<ul style="list-style-type: none"> • Late/Normal/Early To adjust Coasting Guidance suggestion.

* The information provided may differ depending on which functions are applicable to your vehicle.

11. Language

Items	Explanation
Language	You can select the language in the User Setting mode.

12. Default

Items	Explanation
Default	You can reset the menus in the User Settings mode. All menus in the User Settings mode are reset to factory settings, except language and service interval.

LCD displays

LCD displays show the following information to drivers.

- Trip information
- LCD modes
- Warning messages

Trip information (trip computer)

The trip computer is a microcomputer- controlled driver information system that displays information related to driving.

* NOTICE

Some driving information stored in the trip computer resets if the battery is disconnected.

Trip modes

Type A

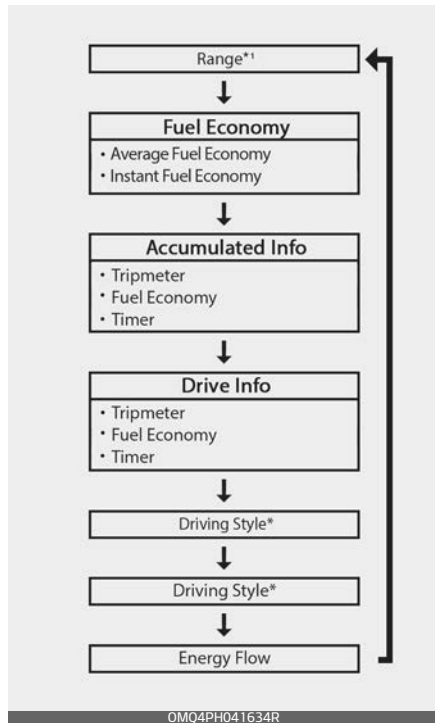

Type B

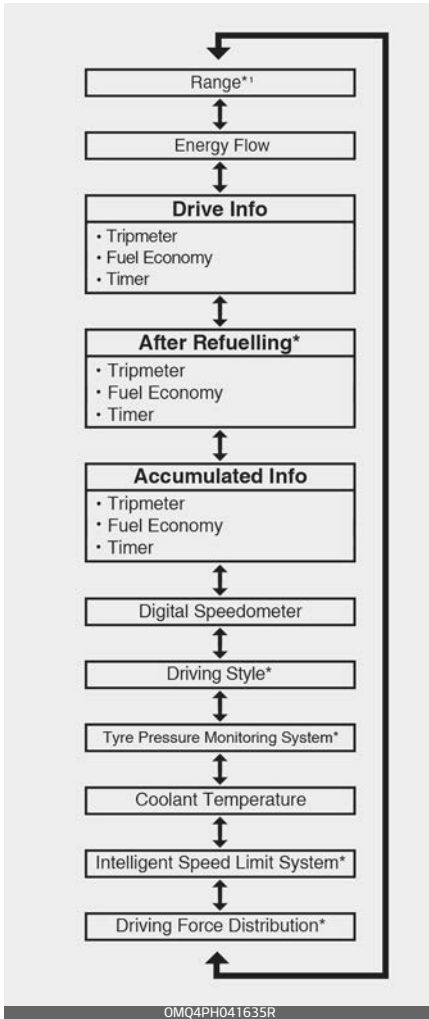

* : if equipped

* 1: For Plug-in Hybrid Vehicle

To change the trip mode, scroll the toggle the switch (∧/∨) on the steering wheel.

Fuel economy

Average Fuel Economy (1)



- The average fuel economy is calculated by the total driving distance and fuel consumption since the last average fuel economy reset.
 - Fuel economy range: 0 ~ 99.9 km/L, L/100 km or mpg

* NOTICE

The average fuel economy is not displayed for more accurate calculation if the vehicle does not drive more than 10 seconds or 50 metres (0.03 mi.) since the ignition switch or ENGINE START/STOP button is turned to ON.

Instant Fuel Economy (2)

- This mode displays the instant fuel economy during the last few seconds when the vehicle speed is more than 10 km/h (6.2 mph).
 - Fuel economy range:

0.0 ~ 30 km/L, L/100 km or 0.0 ~ 50.0 mpg

Accumulated driving information mode

This display shows the accumulated trip distance (1), the average fuel efficiency (2), and the total driving time (3).



- Accumulated information is calculated after the vehicle has run for more than 300 metres.
- If you press "OK" button for more than 1 second after the Cumulative Information is displayed, the information will be reset.
- If the engine is running, even when the vehicle is not in motion, the information will be accumulated.

Drive info display

This display shows the trip distance (1), the average fuel efficiency (2), and the total driving time (3) information once per one ignition cycle.



- Fuel efficiency is calculated after the vehicle has run for more than 300 metres.
- (For hybrid vehicle) The vehicle will automatically set to default once 4 hours pass after the Ignition is in OFF.
(For plug-in hybrid vehicle) The information will automatically reset when the driver's door is opened after the ignition is turned off, or approximately 3 minutes have passed after the ignition is turned off.
- If the engine is running, even when the vehicle is not in motion, the information will be accumulated.

Digital speedometer

This digital speedometer display shows the speed of the vehicle.



Range (Plug-in hybrid vehicle)

The range is the estimated distance the vehicle can be driven with the remaining high-voltage (hybrid) battery (1, Electric) and fuel in the fuel tank (2, Petrol).



- If the estimated distance is below 1 km (1 mi.), the trip computer will display "----" as distance to empty.
 - Distance range: 1 ~ 510 km or 1 ~ 510 mi.

* NOTICE

- If the vehicle is not on level ground or the battery power has been interrupted, the range function may not operate correctly.
- The range may differ from the actual driving distance as it is an estimate of the available driving distance.
- The trip computer may not register additional fuel if less than 6 litres (1.6 gallons) of fuel are added to the vehicle.
- The range may vary significantly based on driving conditions, driving habits, and condition of the vehicle.

Energy flow

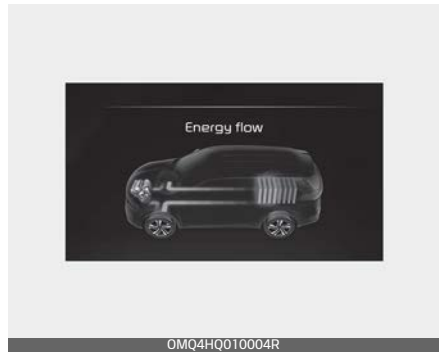

The hybrid system informs the driver about its energy flow in various operating modes. Whilst driving, the current energy flow is specified in 11 modes.

* For more details, refer to "Energy flow" on page 1-42.

Service mode

This mode reminds you of scheduled maintenance information.

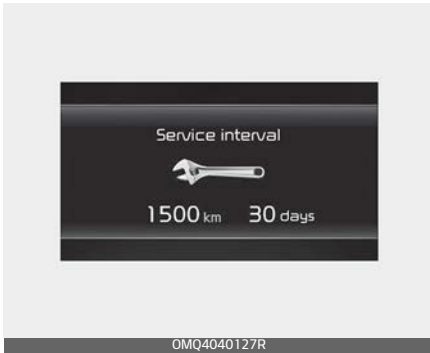

Service in

It calculates and displays when you need a scheduled maintenance service (mileage or days).

If the remaining mileage or time reaches 1,500 km (900 mi.) or 30 days, "Service in" message is displayed for several seconds each time you set the ignition switch or ENGINE START/STOP Button to the ON position.

Service required

If you do not have your vehicle serviced according to the already inputted service interval, "Service required" message is displayed for several seconds each time you set

the ignition switch or ENGINE START/STOP Button to the ON position.

To reset the service interval to the mileage and days you inputted before:

- Press the OK button (Reset) for more than 1 second.

*** NOTICE**

If any of the following conditions occurs, the mileage and days may be incorrect.

- The battery cable is disconnected.
- The battery is discharged.

Driving info display

At the end of each driving cycle, the Driving Info message is displayed.

Type A

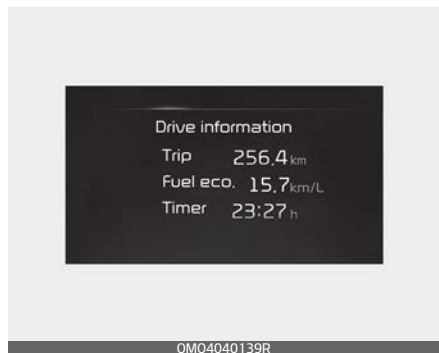

Type B



This display shows the trip distance (1), average fuel economy (2), driving time (3).

This information is displayed for a few seconds when you turn off the vehicle, and then goes off automatically. The information is calculated for each time the vehicle is turned on.

*** NOTICE**

- If sunroof open warning is displayed in the cluster, the Driving Information message may not be displayed.
- To set the charging time and/or climate time, refer to a separately supplied car navigation system manual for detailed information.

LCD display messages

Door, bonnet, tailgate, sunroof open



- This warning is displayed indicating which door, the bonnet, the tailgate or the sunroof is open.

Low tyre pressure warning display



This warning message is displayed if the tyre pressure is low. The corresponding tyre on the vehicle will be illuminated.

* For more details, refer to "Tyre Pressure Monitoring System

(TPMS) (if equipped)" on page 7-10.

Lights mode



This indicator displays which exterior light is selected using the lighting control.

You can activate or deactivate Wiper/Lights Display function from the User Settings mode in the cluster LCD display.

Wiper mode



This indicator displays which wiper speed is selected using the wiper control.

You can activate or deactivate Wiper/Lights Display function from the User Settings mode in the cluster LCD display.

Low washer fluid



This warning message is displayed if the washer fluid level in the reservoir is nearly empty.

Have the washer fluid reservoir refilled.

Icy road warning



OMQ4040163R

This warning is to warn the driver the road may be icy.

When the following conditions occur, the warning light (including Outside Temperature Gauge) blinks 5 times and then illuminates, and also warning chime sounds once.

- The temperature on the Outside Temperature Gauge is below approximately 4 °C (40 °F).

*** NOTICE**

If the icy road warning appears whilst driving, you should drive more attentively and safely refraining from over-speeding, rapid acceleration, sudden braking or sharp turning, etc.

Engine overheated

- This warning message illuminates when the engine coolant temperature is above 120 °C (248 °F). This means that the engine is overheated and may be damaged.
- * If your vehicle is overheated, refer to "If the engine overheats" on page 7-8.

Low key battery (for smart key system)

- This warning message illuminates if the battery of the smart key is discharged when the ENGINE START/STOP Button changes to the OFF position.

Press START button whilst turning wheel (for smart key system)

- This warning message illuminates if the steering wheel does not unlock normally when the ENGINE START/STOP Button is pressed.
- It means that you should press the ENGINE START/STOP Button whilst turning the steering wheel right and left.

Steering wheel not locked (for smart key system)

- This warning message illuminates if the steering wheel does not lock when the ENGINE START/STOP Button changes to the OFF position.

Check steering wheel lock system (for smart key system)

- This warning message illuminates if the steering wheel does not lock normally when the ENGINE START/STOP Button changes to the OFF position.

Key not in vehicle (for smart key system)

- This warning message illuminates if the smart key is not in the vehicle when you press the ENGINE START/STOP Button.
- It means that you should always have the smart key with you.

Key not detected (for smart key system)

- This warning message illuminates if the smart key is not detected when you press the ENGINE START/STOP Button.

Shift to P or N to start engine (for smart key system)

- This warning message illuminates if you try to start the engine with the gear not in the P (Park) or N (Neutral) position.

Press brake pedal to start engine (for smart key system)

- This warning message illuminates if the ENGINE START/STOP Button changes to the ACC position twice by pressing the button repeatedly without depressing the brake pedal.
- It means that you should depress the brake pedal to start the engine.

Battery discharging due to external electrical devices

The vehicle can detect self-discharge of the battery due to over-current that is generated by unauthorised electrical devices such as dashboard camera (dash cam) mounting during parking.

If the warning continues even after external electrical devices are removed, have your vehicle inspected by a professional workshop. Kia recommends to contact an authorised Kia dealer/service partner.

Press START button again (for smart key system)

- This warning message illuminates if you can not operate the ENGINE START/STOP Button when there is a problem with the ENGINE START/STOP Button system.

- It means that you could start the engine by pressing the Engine Start/ Stop Button once more.
- If the warning illuminates each time you press the ENGINE START/STOP Button, have the vehicle inspected by a professional workshop. Kia recommends to visit an authorised Kia dealer/service partner.

Press START button with key (for smart key system)

- This warning message illuminates if you press the ENGINE START/STOP Button whilst the warning message "Key not detected" is illuminating.
- At this time, the immobiliser indicator light blinks.

Check BCW system (if equipped)

This warning message is displayed if there is a problem with Blind spot Collision Warning. In this case, we recommend that you have the vehicle inspected by an authorised Kia dealer/service partner.

Coasting guide (if equipped)

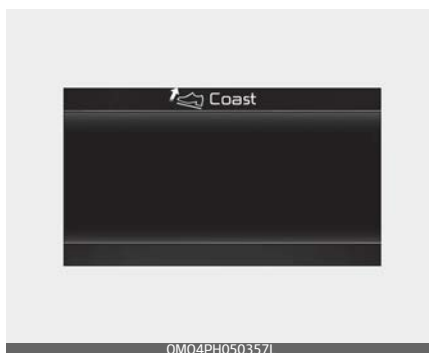

A chime will sound and the coasting guide indicator will be displayed to inform the driver when to take the foot off the accelerator by anticipating a decelerating event* based on the analysis of driving routes and road conditions stored in the navigation system. It encourages the driver to remove the foot from the pedal and allow coasting down the road with EV motor only. This helps preventing unnecessary fuel consumption and increases fuel efficiency.

- * Example of a deceleration event is going down an extended hill, slowing down approaching a toll booth, and approaching reduced speed zones.
- User settings
Press the ENGINE START/STOP button and put the shift dial in P (Park). In the User Settings Mode, select Driver assistance, Coasting Guide, and then On to turn on the

system. Cancel the selection of coasting guide to turn off the system. For the explanation of the system, press and hold the [OK] button.

- Operation conditions
To activate the system, take the following procedures. Enter your destination information on the navigation and select the driving route. Select the ECO mode in the Integrated Driving Control System. Then, satisfy the following:
 - The driving speed should be between 30 km/h (19 mph) and 160 km/h (99 mph).

* The operating speed may vary due to difference between instrument cluster and navigation effected by tyre inflation level.

Unplug vehicle to start (Plug-in hybrid vehicle)

The message is displayed when you start the engine without unplugging the charging cable. Unplug the charging cable, and then start the vehicle.

Remaining Time (Plug-in hybrid vehicle)

The message is displayed to notify the remaining time to fully charge the battery.

Shift to P to charge (Plug-in hybrid vehicle)

The message is displayed when the charging connector is plugged with the shift dial in R (Reverse), N (Neutral) or D (Drive). Move the shift dial to P (Park) and re-start the charging process.

Electric mode/Automatic mode/ Hybrid mode (Plug-in hybrid vehicle)

A corresponding message is displayed when a mode is selected by pressing the HEV button.

Low battery. Maintaining Hybrid mode (Plug-in hybrid vehicle)

This message is displayed when unable to convert to EV mode even when pressing the HEV button during HEV mode driving due to insufficient high-voltage (hybrid) battery level.

Low system temperature. Switching to Hybrid mode/ High system temperature. Switching to Hybrid mode (Plug-in hybrid vehicle)

This message is displayed when the temperature of the high-voltage (hybrid) battery is too low or high.

This warning message is to protect the battery and the hybrid system.

Low system temperature. Maintaining Hybrid mode/ High system temperature. Maintaining Hybrid mode (Plug-in hybrid vehicle)

This message is displayed when the temperature of the high-voltage (hybrid) battery is too low or too high. This warning message is to protect the battery and the hybrid system.

Wait until fuel lid opens (Plug-in hybrid vehicle)

This message is displayed when you attempt to open the fuel lid with the fuel tank pressurised. Wait until the fuel tank is depressurised.

Fuel lid open (Plug-in hybrid vehicle)

This message is displayed when the fuel filler lid opens after the fuel tank is depressurised. If this message is displayed, you can refuel the fuel tank.

Charging stopped. Please check the AC charger (Plug-in hybrid vehicle)

This messages is displayed when the charging failed by external charger error.

The purpose of this message is to let you know the error has occurred in the charger itself, not in the vehicle.

Charging stopped. Please check the cable connection (Plug-in hybrid vehicle)

This messages is displayed when charging is stopped because the charging connector is not correctly connected to the charging inlet. If this occurs, separate the charging connector and re-connect it and check whether there is any problem (external damage, foreign substances, etc.) with the charging connector and charging inlet. If the same problem occurs when charging the vehicle with a replaced charging cable or genuine Kia portable charger, have the vehicle inspected by a professional workshop. Kia recommends to visit an authorised Kia dealer/service partner.

Charging Door Open (Plug-in hybrid vehicle)

This message indicates that the charging door is open whilst in driving- ready state to encourage you to inspect and close the door. (Driving with the charging door open may result in moisture inflow or damage. This message is used to prevent such occurrences.)

Switching to Hybrid mode to allow heating or air conditioning (Plug-in hybrid vehicle)

- When the outdoor temperature is lower than -15 °C (5 °F) and the coolant temperature is lower than 70 °C (158 °F), you turn the climate control On for heating, the above message will be displayed in the cluster. Then, the vehicle will automatically switch to HEV mode and EV mode will not be activated (although EV/HEV button is pressed)
- When the outdoor temperature is higher than -10 °C (14 °F), or the coolant temperature is higher than 80 °C (176 °F) or you turn the climate control Off, the vehicle will automatically return to EV mode.

Switching to Hybrid mode for self-diagnosis (Plug-in hybrid vehicle)

This message is displayed for self-diagnosis of the hybrid mode system.

Low fuel

- This warning message is displayed if the fuel tank is almost out of fuel.
- When this message is displayed, the low fuel level warning light in the cluster will come on.
- It is recommended to look for the nearest fueling station and refuel as soon as possible.

Warning and indicator lights

The warning light and indicator light indicate a situation where the driver should be careful and whether the various functions are activated.

Warning lights

The warning light indicates situations that require the driver to pay attention.

* NOTICE

Make sure that all warning lights are OFF after starting the engine. If any light is still ON, this indicates a situation that needs attention.

Air bag warning light

This warning light illuminates:

- Once you set the ignition switch or ENGINE START/STOP Button to the ON position.
 - It illuminates for approximately 6 seconds and then goes off.
- When there is a malfunction with the SRS.

In this case, have the vehicle inspected by a professional workshop. Kia recommends to visit an authorised Kia dealer/service partner.

Seat belt warning light

This warning light informs the driver that the seat belt is not fastened.

* For more details, refer to "Seat belts" on page 4-23.

Parking brake & brake fluid warning light

This warning light illuminates:

- Once you set the ignition switch or ENGINE START/STOP Button to the ON position.
 - It illuminates for approximately 3 seconds
 - It remains on if the parking brake is applied.
- When the parking brake is applied.
- When the brake fluid level in the reservoir is low.
 - If the warning light illuminates with the parking brake released, it indicates the brake fluid level in reservoir is low.

If the brake fluid level in the reservoir is low:

1. Drive carefully to the nearest safe location and stop your vehicle.
2. With the engine stopped, check the brake fluid level immediately and add fluid as required (For more details, refer to "Brake fluid" on page 8-37). Then check all brake components for fluid leaks. If any leak on the brake system is

still found, the warning light remains on, or the brakes do not operate properly, do not drive the vehicle.

In this case, have the vehicle towed to a professional workshop and inspected. Kia recommends to visit an authorised Kia dealer/service partner.

Dual-diagonal braking system

Your vehicle is equipped with dual-diagonal braking systems. This means you still have braking on two wheels even if one of the dual systems should fail.

With only one of the dual systems working, more than normal pedal travel and greater pedal pressure are required to stop the vehicle. Also, the vehicle will not stop in as short a distance with only a portion of the brake system working. If the brakes fail whilst you are driving, shift to a lower gear for additional engine braking and stop the vehicle as soon as it is safe to do so.

WARNING

Parking brake & brake fluid warning light

Driving the vehicle with a warning light ON is dangerous. If the parking brake & brake fluid warning light illuminates with the parking brake released, it indicates that the brake fluid level is low.

In this case, have the vehicle inspected by a professional workshop. Kia recommends to visit an authorised Kia dealer/service partner.

Regenerative brake warning light (red colour) (yellow colour)

This warning light illuminates:

When the regenerative brake does not operate and the brake does not perform well. This causes the Brake Warning Light (red) and Regenerative Brake Warning Light (yellow) to illuminate simultaneously.

In this case, drive safely and have the vehicle inspected by a professional workshop. Kia recommends to visit an authorised Kia dealer/service partner.

The operation of the brake pedal may be more difficult than normal and the braking distance can increase.

Anti-lock brake system (ABS) warning light

This warning light illuminates:

- Once you set the ignition switch or ENGINE START/STOP button to the ON position.
 - It illuminates for approximately 3 seconds and then goes off.
- When there is a malfunction with the ABS (The normal braking system will still be operational with-

out the assistance of the anti-lock brake system).

In this case, have the vehicle inspected by a professional workshop. Kia recommends to visit an authorised Kia dealer/service partner.

Electronic Brake Force Distribution (EBD) system warning light

These two warning lights illuminate at the same time whilst driving:

- When the ABS and regular brake system may not work normally.

In this case, we recommend that you have the vehicle inspected by an authorised Kia dealer/service partner.

WARNING

Electronic Brake Force Distribution (EBD) system warning light

When both ABS and parking brake & brake fluid warning lights are on, the brake system will not work normally and you may experience an unexpected and dangerous situation during sudden braking.

In this case, avoid high speed driving and abrupt braking.

We recommend you have the vehicle inspected by an authorised Kia dealer/service partner as soon as possible.

*** NOTICE**

Electronic Brake Force Distribution (EBD) system warning light

When the ABS warning light is on or both ABS and parking brake & brake fluid warning lights are on, the speedometer, odometer, or tripmeter may not work. Also, the EPS Warning Light may illuminate and the steering effort may increase or decrease.

In this case, we recommend you have the vehicle inspected by an authorised Kia dealer/service partner as soon as possible.

Electronic Parking Brake (EPB) warning light

This warning light illuminates:

- Once you set the ignition switch or ENGINE START/STOP button to the ON position.
 - It illuminates for approximately 3 seconds and then goes off.
- When there is a malfunction with the EPB.

In this case, we recommend that you have the vehicle inspected by an authorised Kia dealer/service partner.

*** NOTICE**

The Electronic Parking Brake (EPB) Warning Light may illuminate when

the Electronic Stability Control (ESC) Indicator Light comes on to indicate that the ESC is not working properly (This does not indicate malfunction of the EPB).

All Wheel Drive (AWD) warning light (if equipped)

This warning light illuminates:

- Once you set the ENGINE START/STOP button to the ON position.
 - It illuminates for approximately 3 seconds and then goes off.
- When there is a malfunction with the AWD.

In this case, Kia recommends to visit an authorised Kia dealer/service partner.

Electric Power Steering (EPS) warning light

This warning light illuminates:

- Once you set the ignition switch or ENGINE START/STOP Button to the ON position.
 - This indicator light comes on after the ignition key is turned to the ON position and then goes out after approximately 3 seconds.
- When there is a malfunction with the EPS.

In this case, have the vehicle inspected by a professional workshop. Kia recommends to visit an

authorised Kia dealer/service partner.

Charging system warning light

This warning light illuminates:

- Once you set the ignition switch or ENGINE START/STOP button to the ON position.
- When there is a malfunction with either the alternator or electrical charging system.

If there is a malfunction with either the alternator or electrical charging system:

1. Drive carefully to the nearest safe location and stop your vehicle.
2. Turn the engine off and check the alternator drive belt for looseness or breakage.

In this case, have the vehicle inspected by a professional workshop. Kia recommends to visit an authorised Kia dealer/service partner.

Malfunction Indicator Lamp (MIL)



This warning light illuminates:

- When you set the ignition switch or the ENGINE START/STOP button to the ON position.
 - The malfunction indicator light illuminates for about 3 seconds and then goes off.

- Whenever there is a malfunction with either the emission control system or the engine or the vehicle powertrain.

If this occurs, we recommend that you have the vehicle inspected by an authorised Kia dealer/service partner.

* NOTICE

Malfunction Indicator Lamp (MIL)

- Driving with the Malfunction Indicator Lamp (MIL) on may cause damage to the emission control system which could affect drivability and/or fuel economy.
- If the enhanced engine protection system becomes activated due to lack of engine oil, engine power will be limited. If such condition continues repeatedly, the Malfunction Indicator Lamp will illuminate.

⚠ CAUTION

If the Malfunction Indicator Lamp (MIL) illuminates, potential catalytic converter damage is possible which could result in loss of engine power. In this case, we recommend that you have the vehicle inspected by an authorised Kia dealer/service partner as soon as possible.

Engine oil pressure warning light



This warning light illuminates:

- Once you set the ignition switch or ENGINE START/STOP Button to the ON position.
 - It remains on until the engine is started.
- When the engine oil pressure is low.

If the engine oil pressure is low:

- Drive carefully to the nearest safe location and stop your vehicle.
- Turn the engine off and check the engine oil level (For more details, refer to "Engine oil and filter" on page 8-28. If the level is low, add oil as required.
- If the warning light remains on after adding oil or if oil is not available, have the vehicle inspected by a professional workshop as soon as possible. Kia recommends to visit an authorised Kia dealer/service partner. Continued driving with the warning light on may cause engine failure.

* NOTICE

- When engine oil pressure decreases due to insufficient engine oil, etc., the Engine Oil Pressure warning light will illuminate.

- The enhanced engine protection system which limits engine power will be activated. If the engine oil pressure is restored, the Engine Oil Pressure warning light and the enhanced engine protection system will turn off.

Service warning light 

This warning light illuminates:

- When you set the ENGINE START/STOP button to the ON position.
 - The service warning light illuminates for approximately 3 seconds and then turns off when all checks have been performed.
- When there is a problem with the hybrid vehicle control system or hardware.

When the warning light illuminates whilst driving, or does not go OFF after starting the vehicle, we recommend that you have the vehicle inspected by an authorised Kia dealer/service partner.

Overspeed warning light ¹²⁰_{km/h} (if equipped)

This warning light blinks:

- When you drive the vehicle more than 120 km/h.
 - This is to prevent you from driving your vehicle with over-speed.

- The overspeed warning chime also sound for approximately 5 seconds.

Low fuel level warning light 

This warning light illuminates:

When the fuel tank is nearly empty.

If the fuel tank is nearly empty:

Add fuel as soon as possible.

CAUTION 

Low fuel level

Driving with the low fuel level warning light on or with the fuel level below "E" can cause the engine to misfire.

Master warning light 

This indicator light illuminates:

- This warning light informs the driver the following situations
 - LED headlamp malfunction (if equipped)
 - Lamp malfunction
 - High Beam Assist malfunction (if equipped)

To identify the details of the warning look at the LCD display. If the warning situation is solved, the master warning light will turn off.

Low tyre pressure warning light**( (if equipped))****This warning light illuminates:**

- Once you set the ignition switch or ENGINE START/STOP button to the ON position.
 - It illuminates for approximately 3 seconds and then goes off.
 - When one or more of your tyres are significantly under inflated. (The location of the underinflated tyres are displayed on the LCD display).
- * For more details, refer to "Tyre Pressure Monitoring System (TPMS) (if equipped)" on page 7-10.

This warning light remains on after blinking for approximately 60 seconds or repeats blinking on and off at the intervals of approximately 3 seconds:

- When there is a malfunction with the TPMS.
In this case, have the vehicle inspected by a professional workshop. Kia recommends to visit an authorised Kia dealer/service partner.
- * For more details, refer to "Tyre Pressure Monitoring System (TPMS) (if equipped)" on page 7-10.

 WARNING**Low tyre pressure**

- Significantly low tyre pressure makes the vehicle unstable and can contribute to loss of vehicle control and increased braking distances.
- Continued driving on low pressure tyres will cause the tyres to over-heat and fail.

 WARNING**Safe stopping**

- The TPMS cannot alert you to severe and sudden tyre damage caused by external factors.
- If you notice any vehicle instability, immediately take your foot off the accelerator pedal, apply the brakes gradually with light force, and slowly move to a safe position off the road.

Exhaust system (PPF) warning light **This warning light illuminates:**

- When there is a malfunction with Petrol Particulate Filter (PPF) system.
- When this warning light illuminates, it may turn off after driving the vehicle:
 - The vehicle should be driven for more than 30 minutes at a

speed of 80 km/h (50 mph) and faster.

- Ensure the following conditions are all met: safe road conditions, transmission 3rd gear or above, and engine speed of 1,500 – 4,000 rpm.

If this warning light blinks in spite of the procedure (at this time the LCD warning message will be displayed), have the PPF system checked by a professional workshop. Kia recommends to visit an authorised Kia dealer/service partner.

▲ CAUTION

Petrol engine with PPF

If you continue to drive with the PPF warning light blinking for a long time, the PPF system can be damaged and fuel consumption can worsen.

LED headlamp warning light 

This warning light illuminates:

- Once you set the ENGINE START/STOP button to the ON position.
 - It illuminates for approximately 3 seconds and then goes off.
- When there is a malfunction with the LED headlamp.

In this case, have the vehicle inspected by a professional workshop. Kia recommends to visit an authorised Kia dealer/service partner.

This warning light blinks:

- When there is a malfunction with a LED headlamp related part.

In this case, have the vehicle inspected by a professional workshop. Kia recommends to visit an authorised Kia dealer/service partner.

Forward Safety light  **(if equipped)**

This indicator light illuminates:

- When there is a malfunction with Forward Collision-Avoidance Assist.

In this case, have the vehicle inspected by a professional workshop. Kia recommends to visit an authorised Kia dealer/service partner.

Icy road warning light 

This indicator light illuminates:

This warning light is to warn the driver the road may be icy. When the temperature on the outside temperature gauge is approximately below 4C (39F) the Icy Road Warning Light and Outside Temperature Gauge blinks and then illuminates. Also, the warning chime sounds 1 time.

Indicator lights

Charging cable connection indicator light (Plug-in hybrid vehicle)

This indicator illuminates in red when the charging cable is connected.

EV mode indicator

This indicator illuminates:

When the vehicle is driven by the electric motor.

- "EV" indicator ON: Vehicle is driven using the electric motor or the petrol engine is stopped.
- "EV" indicator OFF: Vehicle is driven using the petrol engine.

Ready indicator

This indicator illuminates:

When the vehicle is ready to be driven.

- ON: Normal driving is possible.
- OFF: Normal driving is not possible, or a problem has occurred.
- Blinking: Emergency driving.

When the ready indicator goes OFF or blinks, there is a problem with the system. If this occurs, we recommend that you have your vehicle inspected by an authorised Kia dealer/service partner.

Electronic stability control (ESC)

indicator light

This indicator light illuminates:

- Once you set the ignition switch or ENGINE START/STOP Button to the ON position.
 - It illuminates for approximately 3 seconds and then goes off.
- When there is a malfunction with the ESC system. In this case, have the vehicle inspected by a professional workshop. Kia recommends to visit an authorised Kia dealer/service partner.

This indicator light blinks:

Whilst the ESC is operating.

- * For more details, refer to "Electronic Parking Brake (EPB)" on page 6-37.

Electronic stability control (ESC)

OFF indicator light

This indicator light illuminates:

- Once you set the ignition switch or ENGINE START/STOP Button to the ON position.
 - It illuminates for approximately 3 seconds and then goes off.
- When you deactivate the ESC system by pressing the ESC OFF button.

* For more details, refer to "Electronic Stability Control (ESC) system" on page 6-48.

AUTO HOLD Indicator light (AUTO HOLD)

This indicator light illuminates:

- **White** When you activate the auto hold system by pressing the AUTO HOLD button.
- **Green** When you stop the vehicle completely by depressing the brake pedal with the auto hold system activated.
- **Yellow** When there is a malfunction with the auto hold system. In this case, have the vehicle inspected by a professional workshop. Kia recommends to visit an authorised Kia dealer/service partner.

* For more details, refer to "AUTO HOLD" on page 6-43.

Immobiliser indicator light (without smart key)

This indicator light illuminates:

- When the vehicle detects the immobiliser in your key properly whilst the ignition switch is ON.
 - At this time, you can start the engine.
 - The indicator light goes off after starting the engine.

This indicator light blinks:

- When there is a malfunction with the immobiliser system. In this case, have the vehicle inspected by a professional workshop. Kia recommends to visit an authorised Kia dealer/service partner.

Immobiliser indicator light (with smart key)

This indicator light illuminates for up to 30 seconds:

- When the vehicle detects the smart key in the vehicle properly whilst the ignition switch is ACC or ON.
 - At this time, you can start the engine.
 - The indicator light goes off after starting the engine.

This indicator light blinks for a few seconds:

- When the smart key is not in the vehicle.
 - At this time, you can not start the engine.

This indicator light illuminates for 2 seconds and goes off:

- When the vehicle can not detect the smart key which is in the vehicle whilst the ENGINE START/STOP Button is ON. In this case, have the vehicle inspected by a professional work-

shop. Kia recommends to visit an authorised Kia dealer/service partner.

This indicator light blinks:

- When the battery of the smart key is weak.
 - At this time, you can not start the engine. However, you can start the engine if you press the ENGINE START/STOP Button with the smart key. (For more details, refer to "Immobiliser system" on page 5-17).
- When there is a malfunction with the immobiliser system. In this case, have the vehicle inspected by a professional workshop. Kia recommends to visit an authorised Kia dealer/service partner.

Turn signal indicator light

This indicator light blinks:

- When you turn the turn signal light on.

If any of the following occurs, there may a malfunction with the turn signal system. In this case, have the vehicle inspected by a professional workshop. Kia recommends to visit an authorised Kia dealer/service partner.

- The indicator light does not blink but illuminates.
- The indicator light blinks more rapidly.

- The indicator light does not illuminate at all.

Low beam indicator light

This indicator light illuminates:

- When the headlights are on.

High beam indicator light

This indicator light illuminates:

- When the headlights are on and in the high beam position.
- When the turn signal switch is pulled into the Flash-to-Pass position.

High Beam Assist indicator light

 (if equipped)
AUTO

This indicator light illuminates:

- When the high beam is on with the light switch in the AUTO light position.
 - If your vehicle detects oncoming or preceding vehicles, High Beam Assist will switch the high beam to low beam automatically.
- * For more details, refer to "High Beam Assist (HBA) (if equipped)" on page 5-143.

Light ON indicator light

This indicator light illuminates:

- When the tail lights or headlights are on.

Front fog indicator light  (if equipped)

This indicator light illuminates:

- When the front fog lights are on.

Rear fog indicator light  (if equipped)

This indicator light illuminates:

- When the rear fog lights are on.

Lane Safety indicator light  (if equipped)

Lane Safety indicator will illuminate when you turn Lane Keeping Assist on by pressing Lane Safety button or Lane Driving Assist button.

If there is a problem with Lane Keeping Assist the yellow Lane Safety indicator will illuminate.

- * For more details, refer to "Lane Keeping Assist (LKA) (if equipped)" on page 6-94.

Cruise Control indicator light  (if equipped)

This indicator light illuminates:

- When Cruise Control is enabled.

- * For more details, refer to "Cruise Control (CC) (if equipped)" on page 6-142.

Downhill Brake Control (DBC) Indicator light 

This indicator light illuminates:

- When you set the ignition switch or ENGINE START/STOP Button to the ON position.
 - It illuminates for approximately 3 seconds and then goes off.
- When you activate the system by pressing the DBC button.

This indicator light blinks:

- When the DBC is operating.

This indicator light illuminates yellow:

- When there is a malfunction with the DBC system.

If this occurs, Kia recommends to visit an authorised Kia dealer/service partner.

- * For more details, refer to "Downhill Brake Control (DBC)" on page 6-51.

SPORT mode indicator light



This indicator light illuminates :

- When you select "SPORT" mode as drive mode.

For more details, refer to "Drive mode integrated control system" on page 6-59.

ECO mode indicator light **This indicator light illuminates:**

- When you select "ECO" mode as drive mode.

For more details, refer to "Drive mode integrated control system" on page 6-59.

SOS warning light SOS**This warning light illuminates:**

- Once you set the ignition switch or ENGINE START/STOP Button to the ON position.

It illuminates for approximately 3 seconds.

- If the red lamp continuously illuminates, a malfunction with the eCall system is expected, so have the system inspected by a professional workshop. Kia recommends to visit an authorised Kia dealer/service partner.

For more details, refer to "Pan-European eCall system (if equipped)" on page 7-40.

Head-Up Display (HUD) (if equipped)

The Head-Up Display is a transparent display that projects an image of certain information from the instrument cluster and navigation system on the windscreen glass.

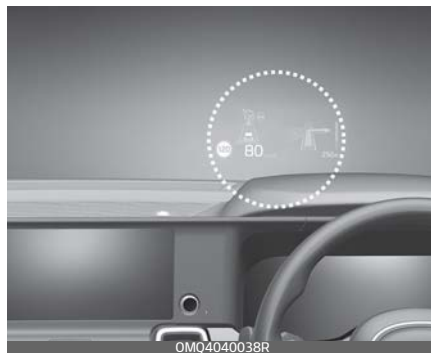

- The head up display image on the HUD screen may be invisible when:
 - Sitting posture is bad.
 - Wearing a polarised sunglasses.
 - There is an object on the cover of the head up display.
 - Driving on a wet road.
 - An inadequate lighting is turned on inside the vehicle.
 - Any light comes from the outside.
 - Wearing an inadequate glasses to your eyesight.
- If the head up display image is not shown well, adjust the height, rotation or illumination of the head up display in the LCD display.

- When the head up display needs inspection or repair, Kia recommends to visit an authorised Kia dealer/service partner.

⚠ WARNING

Head-Up Display

- Do not make the front windscreen glass have window tint or other types of metallic coating. Otherwise, the Head-Up Display image may be invisible.
- Do not place any accessories on the crash pad or attach any objects on the windscreen glass.
- As Blind-Spot Collision Warning is a supplemental device for your safe driving, it may be dangerous to rely on only the BCW information of the Head-Up Display image when changing the lane. Always pay attention to drive safely.

⚠ CAUTION

When replacing the front windscreen glass of the vehicles equipped with the Head-Up Display, replace it with a windscreen glass designed for the Head-Up Display operation. Otherwise, duplicated images may be displayed on the windscreen glass.

Head Up Display Information

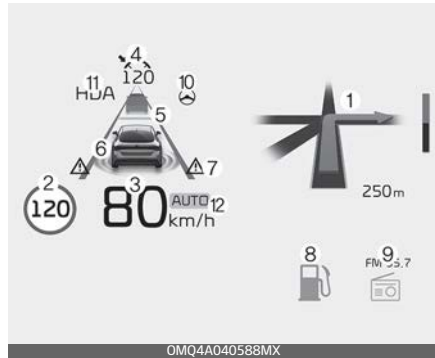

1. Turn By Turn navigation information (if equipped)
2. Road signs
3. Speedometer
4. SCC setting speed information (if equipped)
5. SCC vehicle distance information (if equipped)
6. Lane Safety information (if equipped)
7. Blind-Spot Safety information (if equipped)
8. Warning lights (Low fuel)
9. AV mode information
10. Lane Following Assist information (if equipped)
11. Highway Driving Assist information (if equipped)
12. Highway Auto Speed Change information (if equipped)

* NOTICE

Road Signs and Turn By Turn navigation information are available depending on the region.

Head-Up Display Setting

On the LCD display, you can change the head up display settings as follows.

1. Display height
2. Rotation
3. Brightness
4. Content selection

* For more details, refer to "LCD display modes" on page 5-81.

Rear View Monitor (RVM) (if equipped)



OMQ4H041011



OMQ4040040R

Rear View Monitor will show the area behind the vehicle to assist you when parking or backing up.

⚠ WARNING

The outside rear view camera does not cover the complete area behind the vehicle. The driver should always check the rear area directly through the rear view mirror and side view mirrors before parking or backing up.

Detecting sensor

Rear view camera

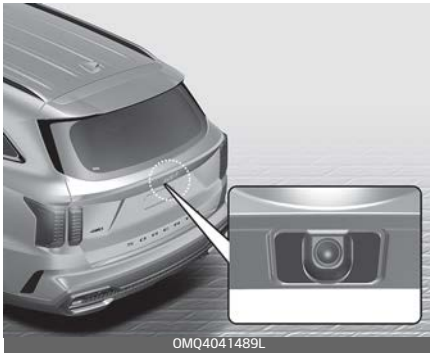

Refer to the picture above for the detailed location of the detecting sensor.

⚠ WARNING

The image shown on the screen may differ from the actual distance of the object. Make sure to directly check the vehicle's surroundings for safety.

⚠ CAUTION

If the camera lens is covered with foreign material, the Rear View Monitor may not operate normally. Always keep the camera lens clean. However, do not use chemical solvents such as strong detergents containing high alkaline or volatile organic solvents (petrol, acetone etc.). This may damage the camera lens.

Function settings

Setting



- You can change Rear View Monitor settings by pressing the setup icon (⚙) on the screen whilst the function is operating, or select 'Driver Assistance → Parking Safety → Camera Settings' from the Settings menu whilst the ENGINE START/STOP button is in the ON position.
- Parking assist rear view settings can be changed in the display information and the screen brightness/contrast value can be changed in the screen settings.
- Select 'Setting → Screen → Keep Rear Camera' from the Settings menu of the Infotainment system to use the Extended rear view function.

Parking/View button



- Press the Parking/View button (1) to turn Rear View Monitor on or off.

Function operation

Rear view with parking guidance

The function will operate when the following conditions are satisfied:

- ENGINE START/STOP button in the ON position
- The gear is changed to R (Reverse) and the back up light turns on

Extended rear view

- When parking, the rear view will maintain showing on the screen if the following conditions are satisfied:
 - The gear is changed from R (Reverse) to N (Neutral) or D (Drive)
 - Vehicle speed is below 10 km/h (6 mph)

- The rear view will turn off when vehicle speed is above 10 km/h (6 mph).

Rear view whilst driving



The driver is able to check the rear view on the screen whilst driving, it is to assist with safe driving.

Operating conditions

- ENGINE START/STOP button is in the ON position.
- Parking/View button (1) is pressed with the gear in D (Drive) or N (Neutral).

Off conditions

- Parking/View button (1) is repressed.
- One of the infotainment system button is pressed.

When operating

- If the gear is changed to R (Reverse), whilst "Rear view whilst driving" is displayed on the screen, the screen will change to rear view with parking guidance.
- When "Rear view whilst driving" is displayed on the screen, an icon will appear on the upper right side of the screen indicating that the rear view is being displayed.

Rear top view

When you touch the icon (1), the top view is displayed on the screen and shows the distance from the vehicle in the back of your vehicle whilst parking.

Malfunction and limitations**Malfunction**

When Rear View Monitor is not working properly, or the screen flickers, or the camera image does not display normally, we recommend that the function be inspected by an authorised Kia dealer/service partner.

Limitations

When the vehicle is stopped for a long time in winter or when the vehicle is parked in an indoor parking lot, the exhaust fumes may temporarily blur the image.

⚠ WARNING

The Rear view whilst driving is a driving assist function. As the appearance on the screen may differ from the actual location, check the front/rear/side view directly for safety.

⚠ WARNING

- Rear View Monitor is not a safety device. It only serves to assist the driver in identifying objects directly behind the middle of the vehicle. The camera does not cover the complete area behind the vehicle.
- Never rely solely on the rear view monitor. As there are blind spots that do not appear on the camera whilst backing up and parking, You must always use methods of viewing the area behind you including looking over both shoulders as well as continuously checking all three rear view mirrors.
- Always look around your vehicle to make sure there are no objects or obstacles before moving the vehicle in any direction to prevent a collision.
- Always pay close attention when the vehicle is driven close to objects, particularly pedestrians, and especially children.
- If the camera lens is covered with foreign material, Surround View Monitor may not operate normally. Always keep the camera lens clean.
However, do not use chemical solvents such as strong detergents containing high alkaline or volatile organic solvents (petrol, acetone

etc.). This may damage the camera lens.

- When stopping for a long time in winter or parking in an indoor parking lot, the image may temporarily be blurry due to the exhaust gas.
-

Surround View Monitor (SVM) (if equipped)



Surround View Monitor will assist in parking by allowing the driver to see around the vehicle.

WARNING

ALWAYS look around your vehicle to make sure there are no objects or obstacles before moving the vehicle. What you see on the screen may differ from the actual vehicle's location.

* NOTICE

For detailed information, scan the QR code in a separately supplied simple manual.

CAUTION

Surround View Monitor is designed to be used on a flat surface. Therefore, if used on roads with different heights such as kerbs and speed bumps, the image in the screen may not look correct.

Detecting sensor

SVM-front view camera (1), SVM-side view camera (2, 3)



SVM-rear view camera (4)



Refer to the picture above for the detailed location of the detecting sensors.

⚠ WARNING

The image shown on the screen may differ from the actual distance of the object. Make sure to directly check the vehicle's surroundings for safety.

⚠ CAUTION

If the camera lens is covered with foreign material, the Surround View Monitor may not operate normally. Always keep the camera lens clean. However, do not use chemical solvents such as strong detergents containing high alkaline or volatile organic solvents (petrol, acetone etc.). This may damage the camera lens.

Function settings

Setting



- You can change Surround View Monitor settings by pressing the setup icon (⚙️) on the screen whilst the function is operating, or select 'Driver Assistance → Parking Safety → Camera Settings' from the Settings menu whilst the ENGINE START/STOP button is in the ON position.

Parking/View button



Press the Parking/View button (1) to turn Rear View Monitor on or off.

Press the button again to turn off the function.

For more details, refer to "Function operation" on page 5-126.

Function operation

Parking assist view

Operating conditions

- The function will operate when the following conditions are satisfied:
 - The gear is changed to R (Reverse)
 - The gear is changed from R (Reverse) to N (Neutral) or D (Drive) when vehicle speed is below 15 km/h (9 mph)
 - Parking/View button (1) is pressed with the gear in D (Drive) or N (Neutral) when vehicle speed is below 15 km/h (9 mph)
 - Parking/View button (1) is pressed with the gear in P (Parking)
 - Parking Distance Warning warns the driver when the gear is in D (Drive). However, 'Driver Assistance → Parking Safety → Camera Settings → Surround View Monitor Auto On' must be selected from the Settings menu.
- An indicator on the screen appears when:
 - The tailgate is opened
 - The driver or front passenger door is opened
 - The outside rearview mirror is folded
- Rear view whilst driving operates regardless of vehicle speed when the gear is in D (Drive) or N (Neutral). Refer to "Rear view whilst driving" on page 5-127.
- Other view modes can be selected by touching the view icons (2) on the Surround View Monitor screen.

Off conditions

- Parking/View button (1) is repressed.
- When vehicle speed is above 15 km/h (9 mph), Surround View Monitor will turn off and the screen will change back to the previous infotainment system screen.
- When the gear is in R (Reverse), Surround View Monitor will turn ON regardless of vehicle speed or button status. However, if vehicle speed is above 15 km/h (9 mph) with the gear in D (Drive), the function will turn off.
- One of the infotainment system button (3) is pressed without the gear in R (Reverse). The screen

will change back to the previous infotainment system screen.

Rear view whilst driving

The driver is able to check the rear view on the screen whilst driving, it is to help with safe driving.

⚠ WARNING

The Rear view whilst driving shown on the screen may differ from the actual distance of the object. Make sure to directly check the vehicle's surroundings for safety.

Operating conditions

- ENGINE START/STOP button is in the ON position.
- Parking/View button (1) is pressed when vehicle speed is above 15km/h (9 mph).
- The icon (2) is touched on the Surround View Monitor screen when vehicle speed is below 15 km/h (9 mph).

Off conditions

- Parking/View button (1) is repressed.
- Other view modes are selected from the Surround View Monitor screen when vehicle speed is below 15 km/h (9 mph).
- One of the infotainment system button (3) is pressed.

When operating

- When Rear view whilst driving is displayed on the screen, the function is maintained regardless of speed whilst driving.
- If the gear is changed to R (Reverse), whilst "Rear view whilst driving" is displayed on the screen, the screen will change to Surround View Monitor.
- When "Rear view whilst driving" is displayed on the screen, an icon will appear on the upper right side of the screen indicating that the rear view is being displayed. Do not get confused with the front wide view icon.

Malfunction and limitations

Malfunction

When Surround View Monitor is not working properly, or the screen flickers, or the camera image does not display normally, we recommend that the function be inspected by an authorised Kia dealer/service partner.

Limitations

When the vehicle is stopped for a long time in winter or when the vehicle is parked in an indoor parking lot, the exhaust fumes may temporarily blur the image.

Reverse Parking Distance Warning (PDW) (if equipped)

Reverse Parking Distance Warning will help warn the driver if a person, an animal or an object is detected within a certain distance when the vehicle is moving in reverse.

Detecting sensor

Rear ultrasonic sensors



Refer to the picture above for the detailed location of the detecting sensors.

Reverse Parking Distance Warning Settings

Warning Volume

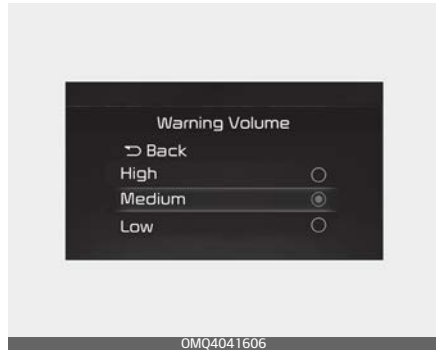

Select 'Settings → Driver Assistance → Warning Volume' from cluster or infotainment system to change the Warning Volume to 'High', 'Medium', 'Low' or 'Off' for Reverse Parking Distance Warning.

* NOTICE

- If you change the Warning Volume, the warning volume of other Driver Assistance systems may change.
- Even if 'Off' is selected, the Warning Volume of Reverse Parking Distance Warning will not turn off but the volume will sound as 'Low'.

Parking Distance Warning Auto On

You can set the Parking Distance Warning to be ON at low speeds. To use Parking Distance Warning Auto On function, select 'Settings → Driver Assistance → Parking Safety → Parking Distance Warning Auto On' from the cluster or the infotainment system with the Engine ON.

*** NOTICE**

If Parking Distance Warning Auto On is selected, the Parking Safety (P) button indicator light will turn on.

Reverse Parking Distance Warning Operation

Parking Safety button (if equipped)



Press the Parking Safety (P) button to turn on or off Reverse Parking Distance Warning.

- When Reverse Parking Distance Warning is off (button indicator light off), if you shift the gear to R (Reverse), Reverse Parking Dis-

tance Warning will automatically turn on.

- If you shift the gear to R (Reverse), Reverse Parking Distance Warning will not turn off even if you press the Parking Safety (P) button for your safety.

Reverse Parking Distance Warning

Reverse Parking Distance Warning will operate under the following conditions.

- Shift the gear to R (Reverse).
- The vehicle's speed is below 10 km/h (6 mph).

Function indications and warnings

Types of warning sound	Indicator
When an object is 24 in~47 in (60 cm~120 cm) from the rear bumper: Buzzer beeps intermittently	
When an object is 12 in~24 in (30 cm~60 cm) from the rear bumper: Buzzer beeps more frequently.	
When an object is within 12 in (30 cm) of the rear bumper: Buzzer beeps continuously.	

- The corresponding indicator will illuminate on the cluster or infotainment whenever each ultrasonic sensor detects a person, animal or object in its sensing range. Also an audible warning will sound.
- When more than two objects are detected at the same time, the closest one will be warned with an audible warning.
- Distance from object may be detected differently when obstacles are not located in front of the sensor.
- The shape of the indicator in the illustration may differ from the actual vehicle.

- The audible warning does not sound.
- The buzzer sounds intermittently.
- The warning message appears on the cluster.

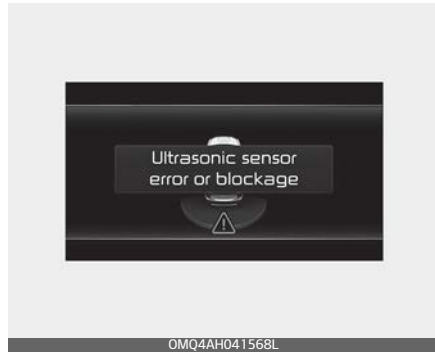

Reverse Parking Distance Warning Malfunction and Precautions

Reverse Parking Distance Warning malfunction

After starting the vehicle, a beep will sound once when the gear is shifted to R (Reverse) to indicate Reverse Parking Distance Warning is operating normally.

However, if one or more of the following occurs, first check whether the ultrasonic sensor is damaged or blocked with foreign material. If it still does not work properly, Kia recommends to visit an authorised Kia dealer/service partner.

Limitations of Reverse Parking Distance Warning

- Reverse Parking Distance Warning may not operate normally when:
 - Moisture is frozen to the sensor (Reverse Parking Distance Warning will operate normally when it is melted.)
 - Sensor is covered with foreign material, such as snow or water (Reverse Parking Distance Warning will operate normally when such foreign material are removed.)
 - The weather is extremely hot or cold
 - The sensor or sensor assembly is disassembled

- The surface of the sensor is pressed hard or an impact is applied with a hard object
- The surface of the sensor is scratched with a sharp object
- The sensors or its surrounding area is directly sprayed with high pressure washer
- Reverse Parking Distance Warning may malfunction when:
 - Heavy rain or water spray is present
 - Water flows on the surface of the sensor
 - Affected by another vehicle's sensors
 - The sensor is covered with snow
 - Driving on uneven road, gravel roads or bushes
 - Objects that generates ultrasonic waves are near the sensor
 - Installing the license plate differently from the original location
 - The vehicle bumper height or ultrasonic sensor installation has been modified
 - Attaching equipments or accessories around the ultrasonic sensors
- The following objects may not be detected:
 - Sharp or slim objects, such as ropes, chains or small poles.
 - Objects, which tend to absorb sensor frequency, such as

clothes, spongy material or snow.

- Objects smaller than 100 cm (40 in.) in length and narrower than 14 cm (6 in.) in diameter.
- Pedestrians, animals or objects that are very close to the ultrasonic sensors

⚠ WARNING

- Reverse Parking Distance Warning is a supplemental function. The operation of Reverse Parking Distance Warning can be affected by several factors (including environmental conditions). It is the responsibility of the driver to always check the rear view before and whilst parking.
- Your vehicle warranty does not cover any accidents or damage to the vehicle due to the malfunction of Reverse Parking Distance Warning.
- Pay close attention when driving near objects, pedestrians, and especially children. Some objects may not be detected by the ultrasonic sensor, due to the objects distance, size material, all of which can limit the effectiveness of the sens.
- Parking Distance Warning indicator may not occur sequentially depending on vehicle speed or obstacle shape.

- If Forward/Reverse Parking Distance Warning needs repair, Kia recommends to visit an authorised Kia dealer/service partner
-

Forward/Reverse Parking Distance Warning (PDW) (if equipped)

Forward/Reverse Parking Distance Warning will warn the driver if an obstacle is detected when the vehicle is moving forward or backward at low speeds.

Detecting sensor

Front ultrasonic sensors



Rear ultrasonic sensors



Refer to the picture above for the detailed location of the detecting sensor.

Forward/Reverse Parking Distance Warning Settings

Warning Volume



Select 'Settings → Driver Assistance → Warning Volume' from cluster or infotainment system to change the Warning Volume to 'High', 'Medium', 'Low' or 'Off' for Reverse Parking Distance Warning.

* NOTICE

- If you change the Warning Volume, the warning volume of other Driver Assistance systems may change.
- Even if 'Off' is selected, the Warning Volume of Reverse Parking Distance Warning will not turn off but the volume will sound as 'Low'.

Parking Distance Warning Auto On

You can set the Parking Distance Warning to be ON at low speeds. To use Parking Distance Warning Auto On function, select 'Settings → Driver Assistance → Parking Safety → Parking Distance Warning Auto On' from cluster or the infotainment system with the Engine ON.

* NOTICE

If Parking Distance Warning Auto On is selected, the Parking Safety (P) button indicator light will turn on.

Forward/Reverse Parking Distance Warning Operation

Parking Safety button (if equipped)



Press the Parking Safety (P) button to turn on or off Forward/Reverse Parking Distance Warning.

- When Reverse Parking Distance Warning is off (button indicator light off), if you shift the gear to R (Reverse), Reverse Parking Distance Warning will automatically turn on.
- If you shift the gear to R (Reverse), Reverse Parking Distance Warning will not turn off even if you press the Parking Safety (P) button for your safety.

Parking Safety button (if equipped)

Forward Parking Distance Warning will operate when one of the condition is satisfied.

- The gear is shifted from R (Reverse) to D (Drive)

The gear is in D (Drive) and the Parking Safety (P) button indicator light is on

- 'Parking Distance Warning Auto On' is selected from the Settings menu and the gear is in D (Drive)
- The function warns the driver when 'Settings → Driver Assistance → Parking Safety → Parking Distance Warning Auto On' is selected from cluster or the infotainment system, and the gear is in D (Drive)
- Vehicle speed is below 10 km/h (6 mph)



*** NOTICE**

- Forward Parking Distance Warning does not operate when the vehicle's forward speed is above

10 km/h (6 mph) even when the function is on (Parking Safety button indicator is on). Forward Parking Distance Warning will operate again when the vehicle's forward speed decreases below 10 km/h (6 mph).

- When the vehicle's forward speed is above 30 km/h (18 mph), the Forward Parking Distance Warning will turn off (Parking Safety button indicator off). Although you drive below 10 km/h (6 mph) again, Forward Parking Distance Warning will not automatically turn on.

Function indications and warnings

Distance from object	Warning indicator when driving forward	Warning sound
24-40 in. (60-100 cm)		Buzzer beeps intermittently
12-24 in. (30-60 cm)		Beeps more frequently
within 12 in. (30 cm)		Beeps continuously

- The corresponding indicator will illuminate on the cluster or infotainment system screen whenever each ultrasonic sensor detects a person, animal or object in its sensing range. Also an audible warning will sound.

- When more than two objects are detected at the same time, the closest one will be warned with an audible warning.
- Distance from object may be detected differently when obstacles are not located in front of the sensor.
- The shape of the indicator in the illustration may differ from the actual vehicle.

Reverse Parking Distance Warning



Reverse Parking Distance Warning will operate when one of the condition is satisfied.

- The gear is shifted to R (Reverse).
- The vehicle's rearward speed is below 10 km/h (6 mph).

*** NOTICE**

When the vehicle's rearward speed is below 10 km/h (6 mph), both the front and rear ultrasonic sensors will detect objects. However, the front ultrasonic sensors can detect a person, animal or object when it is within 60 cm (24 in.) from the sensors.

Function indications and warnings

Distance from object	Warning indicator when driving backward	Warning sound
24~48 in. (60~120 cm)		Buzzer beeps intermittently
12~24 in. (30~60 cm)		Beeps more frequently
within 12 in. (30 cm)		Beeps continuously

- The corresponding indicator will illuminate on the cluster or infotainment system screen whenever each ultrasonic sensor detects a person, animal or object in its sensing range. Also an audible warning will sound.
- When more than two objects are detected at the same time, the closest one will be warned with an audible warning.
- Distance from object may be detected differently when obstacles are not located in front of the sensor.
- The shape of the indicator in the illustration may differ from the actual vehicle.

Forward/Reverse Parking Distance Warning Malfunction and Precautions

Forward/Reverse Parking Distance Warning malfunction

After starting the vehicle, a beep will sound once when the gear is shifted to R (Reverse) to indicate Forward/Reverse Parking Distance Warning is operating normally.

However, if one or more of the following occurs, first check whether the ultrasonic sensor is damaged or blocked with foreign material. If it still does not work properly, Kia recommends to visit an authorised Kia dealer/service partner.

- The audible warning does not sound.
- The buzzer sounds intermittently.
- The warning message appears on the cluster.



Limitations of Forward/Reverse Parking Distance Warning

- Forward/Reverse Parking Distance Warning may not operate normally when:
 - Moisture is frozen to the sensor (Reverse Parking Distance Warning will operate normally when it is melted.)
 - Sensor is covered with foreign material, such as snow or water (Reverse Parking Distance Warning will operate normally when such foreign material are removed.)
 - The weather is extremely hot or cold
 - The sensor or sensor assembly is disassembled
 - The surface of the sensor is pressed hard or an impact is applied with a hard object
 - The surface of the sensor is scratched with a sharp object
 - The sensors or its surrounding area is directly sprayed with high pressure washer
- Forward/Reverse Parking Distance Warning may malfunction when:
 - Heavy rain or water spray is present
 - Water flows on the surface of the sensor
 - Affected by another vehicle's sensors
 - The sensor is covered with snow

- Driving on uneven road, gravel roads or bushes
 - Objects that generates ultrasonic waves are near the sensor
 - Installing the license plate differently from the original location
 - The vehicle bumper height or ultrasonic sensor installation has been modified
 - Attaching equipments or accessories around the ultrasonic sensors
 - The following objects may not be detected:
 - Sharp or slim objects, such as ropes, chains or small poles.
 - Objects, which tend to absorb sensor frequency, such as clothes, spongy material or snow.
 - Objects smaller than 100 cm (40 in.) in length and narrower than 14 cm (6 in.) in diameter.
 - Pedestrians, animals or objects that are very close to the ultrasonic sensors
- WARNING**
- Forward/Reverse Parking Distance Warning is a supplemental function. The operation of Forward/Reverse Parking Distance Warning can be affected by several factors (including environmental conditions). It is the responsibility of the driver to always check the rear view before and whilst parking.
 - Your vehicle warranty does not cover any accidents or damage to the vehicle due to the malfunction of Reverse Parking Distance Warning.
 - Pay close attention when driving near objects, pedestrians, and especially children. Some objects may not be detected by the ultrasonic sensors, due to the objects distance, size material, all of which can limit the effectiveness of the sensor.
 - Parking Distance Warning indicator may not occur sequentially depending on vehicle speed or obstacle shape.
 - If Forward/Reverse Parking Distance Warning needs repair, Kia recommends to visit an authorised Kia dealer/service partner

Lighting

This vehicle is equipped with a variety of lights to illuminate the interior and exterior of the vehicle.

CAUTION

To prevent the battery from being discharged, do not leave the headlight and interior light on for a prolonged time whilst the engine is not running.

Battery saver function

The purpose of this feature is to prevent the battery from being discharged.

The system automatically shuts off the parking lights after the engine is off and the driver's door is opened.

However, the position lamps stay ON even when the driver-side door is opened if the light switch is operated after the engine is turned off.

If necessary, to keep the lamps on turn the position lamps OFF and ON again using the headlamp switch on the steering column after the engine is turned off.

Headlight escort function

If you turn the ignition switch to the ACC or OFF position with the headlights ON, the headlights remain on for about 5 minutes. However, if the driver's door is opened and closed, the headlights are turned off after 15 seconds.

The headlights can be turned off by pressing the lock button on the transmitter (or smart key) twice or turning the light switch to the OFF position.

Daytime Running Light (DRL)

The Daytime Running Light (DRL) can make it easier for others to see the front of your vehicle during the day.

The DRL can be helpful in many different driving conditions, and it is especially helpful after dawn and before sunset.

The DRL will turn the dedicated lamp OFF when:

- The headlight switch is on.
- The vehicle is off.
- The front fog light is on. (if equipped)
- Engaging the parking brake.

Traffic Change

The low beam light distribution is asymmetric. If you go abroad to a country with opposite traffic direction, this asymmetric part will dazzle oncoming car driver. To prevent dazzle, ECE regulation demand several technical solutions (e.g. automatic change system, adhesive sheet, down aiming). This headlamps are designed not to dazzle opposite drivers. So, you need not change your headlamps in a country with opposite traffic direction.

Lighting control

The light switch has a headlight and a position lamp position.



OMQ4PH040578L



OMQ4PH040578R

To operate the lights, turn the knob at the end of the control lever to one of the following positions:

1. OFF position
2. Auto light position

3. Position & Tail lamp
4. Headlight position

Position & Tail lamp



OMQ4PH040579L



OMQ4PH040579R

When the light switch is in the position lamp position, the front position lamp, taillamp, and the license plate lamp will turn ON.

Head light (Low Beam)



OMQ4PH040580L



OMQ4PH040580R

When the light switch is in the head light position, head light (low beam), tail, license light will turn ON.

*** NOTICE**

The ignition switch or ENGINE START/STOP button must be in the ON position to turn on the headlights.

Auto light

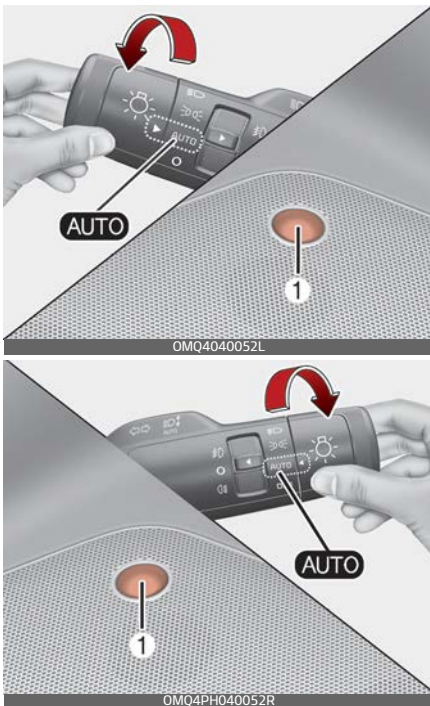

When the light switch is in the AUTO light position, the taillights and headlights will turn ON or OFF auto-

matically depending on the amount of light outside the vehicle.

⚠ CAUTION

- Never place anything over the sensor (1) located on the instrument panel as this will ensure better auto-light system control.
- Don't clean the sensor using a window cleaner, the cleaner may leave a light film which could interfere with sensor operation.
- If your vehicle has window tint or other types of metallic coating on the front windscreen, the Auto light system may not work properly.

Operating high beam 



To turn on the high beam headlamp:

- Push the lever away from you.

The lever will return to its original position.

The high beam indicator will light when the headlight high beams are switched on.

WARNING

Do not use high beam when there are other vehicles. Using high beam could obstruct the other driver's vision.

To flash the headlights:

- Pull the lever towards you.



It will return to the normal (low beam) position when released. The headlight switch does not need to be on to use this flashing feature.

Operating turn signals and lane change signals

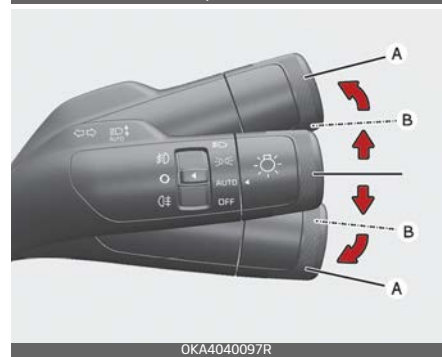
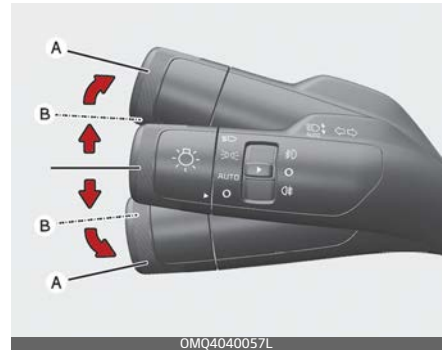

The ENGINE START/STOP button must be on for the turn signals to function.

To turn on the turn signals:

- Move the lever up or down (A). The green arrow indicators on the instrument panel indicate which turn signal is operating. They will self-cancel after a turn is completed. If the indicator continues to flash after a turn, manually return the lever to the OFF position.

To signal a lane change:

- Move the turn signal switch slightly and hold it in position (B). The lever will return to the OFF position when released.

If an indicator stays on and does not flash or if it flashes abnormally, one of the turn signal bulbs may be burned out and will require replacement.

One-touch lane change function

To activate a one-touch lane change function, move the turn signal switch slightly and then release it. The lane change signals will blink 3, 5 or 7 times.

You can activate or deactivate the One Touch Turn Signal function or choose the number of blinking (3, 5, or 7) by selecting "User Settings → Lights → One Touch Turn signal".

*** NOTICE**

If an indicator flash is abnormally quick or slow, a bulb may be burned out or have a poor electrical connection in the circuit.

Operating front fog light \neq (if equipped)

Fog lights are designed to provide improved visibility when visibility is poor due to fog, rain or snow, etc.



The fog lights will turn on when the fog light switch (1) is turned to the on position after the headlight is turned on.

To turn off the fog lights:

- Turn the fog light switch (1) to the ON position.

⚠ CAUTION

When in operation, the fog lights consume large amounts of vehicle electrical power. Only use the fog lights when visibility is poor.

Operating rear fog light (if equipped)



To turn the rear fog lights on, turn the rear fog light switch (1) to the on position when the headlight is turned on.

Also, the rear fog lights turn on when the rear fog light switch is turned on after the front fog light switch (if equipped) is turned on and the headlight switch is in the parklight position.

To turn the rear fog lights off:

- Turn the rear fog light switch to the on position again.

High Beam Assist (HBA) (if equipped)



High Beam Assist is a function that automatically adjusts the headlamp range (switches between high beam and low beam) depending on the brightness of detected vehicles and certain road conditions.

Detecting sensor

Front view camera



The front view camera is used as a detecting sensor to detect ambient light and brightness whilst driving. Refer to the picture above for the detailed location of the detecting sensor.

* NOTICE

- Always keep the front view camera in good condition to maintain optimal performance of High Beam Assist.
- For more details on the precautions of the front view camera, refer to "Forward Collision-Avoidance Assist (FCA) (Front view camera only) (if equipped)" on page 6-65.

Function setting

With the ENGINE START/STOP button in the ON position, select 'Lights → High Beam Assist (or HBA (High Beam Assist))' from the Settings menu to turn on High Beam Assist function.

⚠ WARNING

For your safety, change the Settings after parking the vehicle at a safe location.

Function operation

- After selecting 'High Beam Assist' in the Settings menu, High Beam Assist will operate by following the procedure below.
 - Place the headlamp switch in the AUTO position and push the headlamp lever towards the instrument cluster. The High Beam Assist (AUTO) indicator light will illuminate on the cluster and the system will be enabled.
 - When the system is enabled, high beam will turn on when vehicle speed is above 40 km/h (25 mph). When vehicle speed is below 25 km/h (15 mph), high beam will not turn on.
 - The High Beam (H) indicator light will illuminate on the cluster when high beam is on.
- When High Beam Assist is operating, if the headlamp lever or switch is used, the function operates as follow:
 - If the headlamp lever is pulled towards you when the high beam is off, the high beam will turn on without High Beam Assist cancelled. When your hand is off the lever, it will move to the middle and the high beam will turn off.
 - If you push the light switch towards the instrument cluster, high beam is turned on and High Beam Assist is released.

- If the headlamp switch is placed from AUTO to another position (headlamp/position/off), High Beam Assist will turn off and the corresponding lamp will turn on.
- When High Beam Assist is operating, high beam switches to low beam if any of the following conditions occur:
 - When the headlamp of an oncoming vehicle is detected.
 - When the tail lamp of a vehicle in front is detected.
 - When the headlamp or tail lamp of a motorcycle or a bicycle is detected.
 - When the surrounding ambient light is bright enough that high beams are not required.
 - When streetlights or other lights are detected.

Malfunction and limitations

Malfunction



When High Beam Assist is not working properly, the 'Check High Beam Assist (HBA) system' warning message will appear and warning light () will illuminate on the cluster. We recommend that you have your vehicle inspected by an authorised Kia dealer/service partner.

Limitations

High Beam Assist may not work properly in the following situations:

- Light from a vehicle is not detected because of lamp damage, or because it is hidden from sight, etc.
- Headlamp of a vehicle is covered with dust, snow or water.
- A vehicle's headlamps are off but the fog lamps are on and etc.
- There is a lamp that has a similar shape as a vehicle's lamp.
- Headlamps have been damaged or not repaired properly.

- Headlamps are not aimed properly.
- Driving on a narrow curved road, rough road, uphill or downhill.
- Vehicle in front is partially visible on a crossroad or curved road.
- There is a traffic light, reflecting sign, flashing sign or mirror ahead.
- There is a temporary reflector or flash ahead (construction area).
- The road conditions are bad such as being wet, iced or covered with snow.
- A vehicle suddenly appears from a curve.
- The vehicle is tilted from a flat tyre or is being towed.
- Light from a vehicle is not detected because of exhaust fume, smoke, fog, snow, etc.

- check the road conditions for your safety.
- When High Beam Assist does not operate normally, change the headlamp position manually between high beam and low beam.

Headlight levelling adjustment switch



To adjust the headlight beam level according to the number of the passengers and loading weight in the luggage area, turn the beam levelling switch.

The higher the number of the switch position, the lower the headlight beam level. Always keep the headlight beam at the proper levelling position, or headlights may dazzle other road users.

Listed below are the examples of proper switch settings. For loading conditions other than those listed below, adjust the switch position so

* NOTICE

For more details on the limitations of the front view camera, refer to "Forward Collision-Avoidance Assist (FCA) (Front view camera only) (if equipped)" on page 6-65.

* NOTICE

- At times, High Beam Assist may not work properly. The system is for your convenience only. It is the responsibility of the driver for safe driving practices and always

that the beam level may be the nearest as the condition obtained according to the list.

Loading condition	Switch position
Driver only	0
Driver + Front passenger	0
Full passengers (including driver)	1
Full passengers (including driver) + Maximum permissible loading	2
Driver + Maximum permissible loading	3

Wipers and washers

The wipers and washers remove foreign substances from the windscreen and rear window, helping to maintain visibility.

Type A

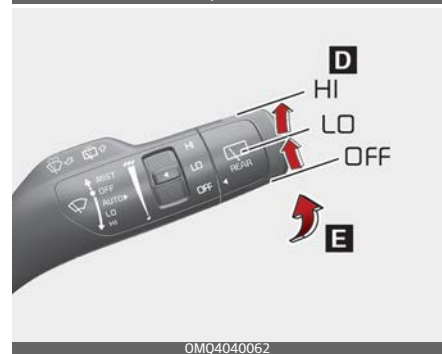
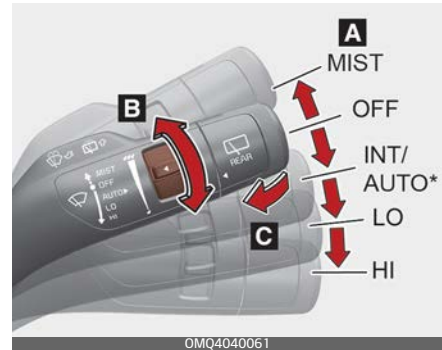

Type B

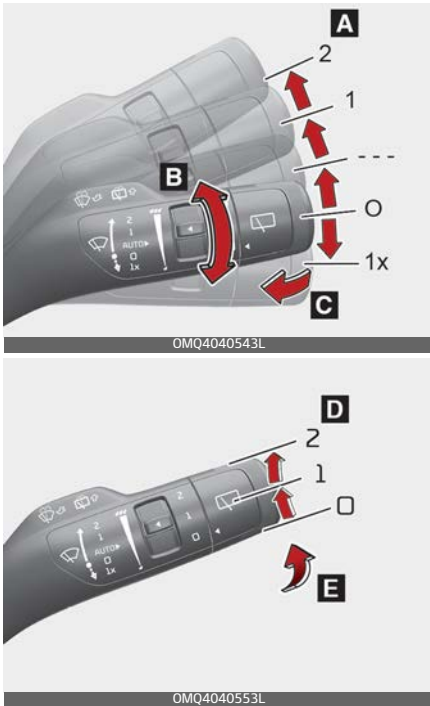

A: Wiper speed control

- MIST / 1x – Single wipe
- OFF / 0 – Off
- INT / --- – Intermittent wipe
- AUTO* – Auto control wipe
- LO / 1 – Low wiper speed
- HI / 2 – High wiper speed

B: Intermittent control wipe time adjustment/Auto control wipe time adjustment*

C: Wash with brief wipes

D: Rear wiper/washer control

- HI / 2 – Continuous wipe
- LO / 1 – Intermittent wipe
- OFF / 0 – Off

E: Wash with brief wipes (rear)

Windscreen wipers

Operate as follows when the ignition switch or ENGINE START/STOP button is ON.

- MIST / 1x: For a single wiping cycle, move the lever to this position and release it. The wipers will operate continuously if the lever is held in this position.
- OFF / 0: Wiper is not in operation
- INT / ---: Wiper operates intermittently at the same wiping intervals. Use this mode in light rain or mist. To vary the speed setting, turn the speed control knob.
- LO / 1: Normal wiper speed
- HI / 2: Fast wiper speed

*** NOTICE**

If there is heavy accumulation of snow or ice on the windscreen, defrost the windscreen for about 10 minutes, or until the snow and/or ice is removed before using the windscreen wipers to ensure proper operation. If you do not remove the snow and/or ice before using the wiper and washer, it may damage the wiper and washer system.

Auto control (if equipped)

Type A

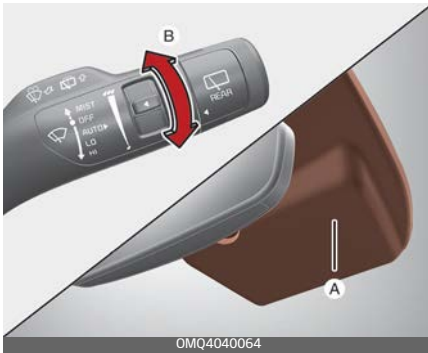

Type B

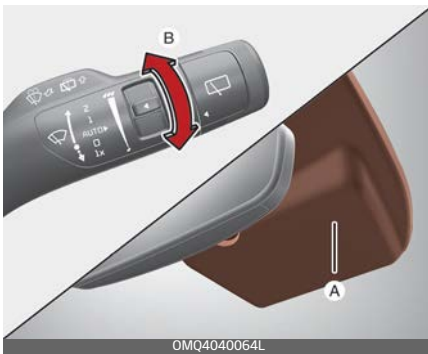

The rain sensor (A) located on the upper end of the windscreen glass senses the amount of rainfall and controls the wiping cycle for the proper interval. The more it rains, the faster the wiper operates. When the rain stops, the wiper stops.

To vary the speed setting, turn the speed control knob (B).

If the wiper switch is set in AUTO mode when the ignition switch or ENGINE START/STOP button is ON,

the wiper will operate once to perform a self-check of the system. Set the wiper to OFF (0) position when the wiper is not in use.

⚠ CAUTION

When the ignition switch or ENGINE START/STOP button is ON and the windscreen wiper switch is placed in the AUTO mode, use caution in the following situations to avoid any injury to the hands or other parts of the body:

- Do not touch the upper end of the windscreen glass facing the rain sensor.
- Do not wipe the upper end of the windscreen glass with a damp or wet cloth.
- Do not put pressure on the windscreen glass.

⚠ CAUTION

- When washing the vehicle, set the wiper switch in the OFF (0) position to stop the auto wiper operation.

The wiper may operate and be damaged if the switch is set in the AUTO mode whilst washing the vehicle.

- Do not remove the sensor cover located on the upper end of the passenger side windscreen glass. Damage to system parts could

- occur and may not be covered by your vehicle warranty.
- When starting the vehicle in winter, set the wiper switch in the OFF (0) position. Otherwise, wipers may operate and ice may damage the windscreen wiper blades. Always remove all snow and ice and defrost the windscreen properly prior to operating the windscreen wipers.
 - When tinting the windscreen, be careful of any fluid getting into the sensor located in the top centre of the front windscreen. It may damage the related parts.

2. Pull the lever gently toward you to spray washer fluid on the windscreen and to run the wipers 1–3 cycles. Use this function when the windscreen is dirty. The spray and wiper operation will continue until you release the lever.

If the washer does not work, check the washer fluid level. If the fluid level is not sufficient, you will need to add appropriate non-abrasive windscreen washer fluid to the washer reservoir.

The reservoir filler neck is located in the front of the engine compartment on the driver side.

Operating windscreen washers

Type A



Type B



1. Move the wiper speed control switch to In OFF (0) position.

⚠ CAUTION

To prevent possible damage to the washer pump, do not operate the washer when the fluid reservoir is empty.

⚠ WARNING

Do not use the washer in freezing temperatures without first warming the windscreen with the defrosters; the washer solution could freeze on the windscreen and obscure your vision.

⚠ CAUTION

- To prevent possible damage to the wipers or windscreen, do not

operate the wipers when the windscreen is dry.

- To prevent damage to the wiper blades, do not use petrol, kerosene, paint thinner, or other solvents on or near them.
- To prevent damage to the wiper arms and other components, do not attempt to move the wipers manually.
- To prevent possible damage to the wipers and washer system, use anti-freezing washer fluids in the winter season or cold weather.

Operating rear window wiper and washer switch

The rear window wiper and washer switch is located at the end of the wiper and washer switch lever.

- Turn the switch to the desired position to operate the rear wiper and washer.

Type A



Type B



- HI / 2 - Normal wiper operation
- LO / 1 - Intermittent wiper operation
- OFF / 0 - Wiper is not in operation
- Push the lever away from you to spray rear washer fluid and to run the rear wipers several times.

Type A



Type B



The spray and wiper operation will continue until you release the lever.

When the front wiper is activated and the gear is switched to R (Reverse) position, the rear wiper will be activated once to provide better visibility.

Welcome system (if equipped)

The welcome system is a function that illuminates the surroundings or the interior when the driver approaches or exits the vehicle.

Door handle lamp (if equipped)



When all the doors (and tailgate) are closed and locked, the door handle lamp will come on for about 15 seconds if any of the below is performed.

- When the door unlock button is pressed on the smart key.
- When the button of the outside door handle is pressed.
- When the vehicle is approached with the smart key in possession.

Headlight (headlamp) escort function

The headlights (and/or taillights) remain on for approximately 5 minutes after the ignition key is removed or turned to the ACC or LOCK position. However, if the driver's door is opened and closed, the headlights are turned off after 15 seconds.

The headlights can be turned off by pressing the lock button on the transmitter or smart key twice or turning off the light switch from the headlight or Auto light position.

Interior light

When the interior light switch is in the DOOR position and all doors (and tailgate) are locked and closed, the room lamp will come on for 30 seconds if any of the following occurs:

- With the smart key system
 - When the door unlock button is pressed on the smart key.
 - When the button of the outside door handle is pressed.

At this time, if you press the door lock button, the lamps will turn off immediately.

Interior lights

This vehicle is equipped with lights throughout the vehicle to illuminate the interior.

CAUTION

Do not use the interior lights for extended periods when the engine is not running.

It may cause battery discharge.

WARNING

Do not use the interior lights when driving in the dark. Accidents could happen because the view may be obscured by interior lights.

Automatic turn off function

The interior lights automatically turn off approximately 20 minutes after the ENGINE START/STOP button is turned off, if the lights are in the ON position.

If your vehicle is equipped with the theft alarm system, the interior lights automatically turn off approximately 5 seconds after the system is armed.

Map lamp

Type A



Type B



- Press the lens (1) to turn ON the map lamp.
To turn the map lamp OFF press the lens (1) again.
-  (2): DOOR mode
 - The map lamp and room lamp come on when a door is opened. The lamps go out after approximately 30 seconds.
 - The map lamp and room lamp come on for approximately 30 seconds when doors are unlocked with a smart key as

long as the doors are not opened.

- The map lamp and room lamp will stay on for approximately 20 minutes if a door is opened with the ENGINE START/STOP button in the ACC or OFF position.
- The map lamp and room lamp will stay on continuously if the door is opened with the ENGINE START/STOP button in the ON position.
- The map lamp and room lamp will go out immediately if the ENGINE START/STOP button is changed to the ON position or all doors are locked.
- To turn off the DOOR mode, press the DOOR button (2) once again (not pressed).
-  (3): Press this switch to turn the front and rear room lamps on and off.

* NOTICE

The DOOR mode and ROOM mode can not be selected at a time.

Room lamp (if equipped)



Personal lamp



Press the switch to turn the room lamp on and off.

Luggage room lamp

- ☀️ : The lamp will always turn on when the tailgate is opened/ closed.
- 🔄 : The lamp is on when the tailgate is opened, and off when the tailgate is closed.
- ☾ : The lamp will always turn off when the tailgate is opened/ closed.

Type A



Type B



The luggage room lamp comes on when the tailgate is opened.

⚠️ CAUTION

The luggage room lamp comes on as long as the tailgate opens. To prevent unnecessary charging system drain, close the tailgate securely after using the luggage room.



Vanity mirror lamp (if equipped)



Push the switch to turn the light on or off.

- ☀️: The lamp will turn on if this button is pressed.
- ○: The lamp will turn off if this button is pressed.

* NOTICE

To prevent unnecessary charging system drain, close the vanity mirror cover after using the mirror.

Glove box lamp (if equipped)



The glove box lamp comes on when the glove box is opened.

* NOTICE

To prevent unnecessary charging system drain, close the glove box securely after using the glove box.

Climate control system



The climate control system uses cooling and heating to help maintain a pleasant environment inside the vehicle.

System operation

Ventilation

1. Set the mode to the  position.
2. Set the air intake control to the outside (fresh) air position.
3. Set the temperature control to the desired position.
4. Set the fan speed control to the desired speed.

Heating

1. Set the mode to the  position.
2. Set the air intake control to the outside (fresh) air position.
3. Set the temperature control to the desired position.
4. Set the fan speed control to the desired speed.
5. If dehumidified heating is desired, turn the air conditioning system on.
 - If the windscreen fogs up, set the mode to the  or  position.

Operation tips

- To keep dust or unpleasant fumes from entering the vehicle through the ventilation system, temporarily set the air intake control to the recirculated air position. Be sure to return the control to the fresh air position when the irritation has passed to keep fresh air in the vehicle. This will help keep the driver alert and comfortable.
- Air for the heating/cooling system is drawn in through the grilles just at the base of the windscreen. Care should be taken that these are not blocked by leaves, snow, ice or other obstructions.
- To prevent fog from forming on the inside of the windscreen:
 - Set the air intake control to the fresh air position and the fan speed to the desired position.
 - Turn on the air conditioning system, and adjust the temperature control to desired temperature.

Air conditioning (A/C)

All Kia air conditioning systems are filled with R-1234yf refrigerant.

1. Start the vehicle. Press the A/C button.
2. Set the mode to the  position.
3. Set the air intake control to the outside-air or recirculated air position.

4. Adjust the fan speed control and temperature control to maintain maximum comfort.

CAUTION

Excessive air conditioning use

When using the air conditioning system, monitor the temperature gauge closely whilst driving up hills or in heavy traffic when outside temperatures are high. Air conditioning system operation may cause vehicle overheating. Continue to use the blower fan but turn the air conditioning system off if the temperature gauge indicates vehicle overheating.

CAUTION

The air conditioning system should only be used with the windows and sunroof closed to prevent condensation inside the vehicle that may cause damage to electrical components.

Air conditioning system operation tips

- If the vehicle has been parked in direct sunlight during hot weather, open the windows for a short time to let the hot air inside the vehicle escape.
- To help reduce moisture inside of the windows on rainy or humid

days, decrease the humidity inside the vehicle by operating the air conditioning system.

- During air conditioning system operation, you may occasionally notice a slight change in vehicle speed as the air conditioning compressor cycles. This is a normal characteristic of system operation.
- To ensure maximum system performance, the air conditioning system should be ran for a few minutes each month.
- When using the air conditioning system, you may notice clear water dripping (or even puddling) on the ground under the passenger side of the vehicle. This is a normal characteristic of system operation.
- Operating the air conditioning system in the recirculated air position provides maximum cooling; however, continual operation in this mode may cause the air inside the vehicle to become stale.
- During cooling operation, you may occasionally notice a misty air flow because of rapid cooling and humid air intake. This is a normal characteristic of system operation.

Climate control air filter

The climate control air filter installed behind the glove box filters the dust or other pollutants that come into the vehicle from the outside through the heating and air conditioning system.

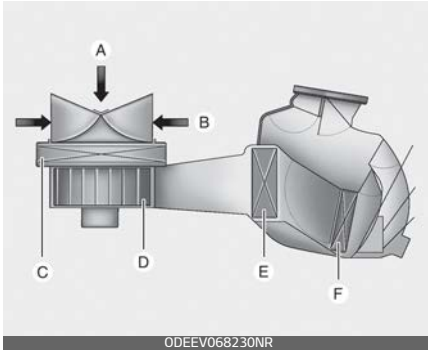

- A: Outside air
- B: Recirculated air
- C: Climate control air filter
- D: Blower
- E: Evaporator core
- F: Heater core

If dust or other pollutants accumulate in the filter over a period of time, the air flow from the air vents may decrease. This leads to moisture accumulating on the inside of the windscreen even when the outside (fresh) air position is selected. If this happens, have the climate control air filter replaced by a professional workshop. Kia recommends to

visit an authorised Kia dealer/service partner.

* NOTICE

- Replace the filter according to the Maintenance Schedule. If the vehicle is being driven in severe conditions such as dusty or rough roads, more frequent air conditioner filter inspections and changes are required.
- When the air flow rate suddenly decreases, have the system checked by a professional workshop. Kia recommends to visit an authorised Kia dealer/service partner.

5

Air conditioning refrigerant label

Type A



Type B



* The actual air conditioning refrigerant label in the vehicle may differ from the illustration.

Each symbol and specification on the air conditioning refrigerant label is represented below:

1. Classification of refrigerant
2. Amount of refrigerant
3. Classification of Compressor lubricant
4. Caution
5. Flammable Refrigerant
6. Registered technician to service Air Conditioning system
7. Service manual

You can find out which air conditioning refrigerant is applied your vehicle at the label inside of the engine compartment.

Refer to "Refrigerant label" on page 9- 14 for more detail on the location of air conditioning refrigerant label.

Checking the amount of air conditioner refrigerant and compressor lubricant

When the amount of refrigerant is low, the performance of the air conditioning is reduced. Overfilling also has a negative impact on the air conditioning system.

Therefore, if abnormal operation is found, have the system inspected by a professional workshop. Kia recommends to visit an authorised Kia dealer/service partner.

⚠ WARNING

Vehicles equipped with R-134a



Because the refrigerant is at very high pressure, the air conditioning system should only be serviced by trained and certified technicians. It is important that the correct type and amount of oil and refrigerant is used. Otherwise, it may cause damage to the vehicle and personal injury.

⚠ WARNING**Vehicles equipped with R-1234yf***

Since the refrigerant is mildly flammable and operated at high pressure, the air conditioning system should only be serviced by trained and certified technicians.

It is important that the correct type and amount of oil and refrigerant are used. All refrigerants should be reclaimed with proper equipment. Venting refrigerants directly to the atmosphere is harmful to individuals and environment. Failure to heed these warnings can lead to serious injuries.

⚠ CAUTION**AC repair**

It is important that the correct type and amount of oil and refrigerant is used, otherwise, damage to the vehicle may occur. To prevent damage, the air conditioning system in your vehicle should only be serviced by trained and certified Kia technicians.

Automatic climate control system

The automatic climate control system uses cooling and heating to help maintain a pleasant environment inside the vehicle.

Type A



Type B



3rd row seat



1. Driver's temperature control button
2. Passenger's temperature control button
3. AUTO (automatic control) button
4. OFF button
5. Fan speed control button
6. Mode selection button
7. Front windscreen defroster button
8. Rear window defroster button
9. SYNC button
10. Air intake control button
11. Air conditioning (A/C) button
12. Driver only select button
13. Climate control display
14. 3rd row air conditioning ON/OFF button (if equipped)
15. 3rd row air conditioning fan speed control knob (if equipped)

* NOTICE

Operating the blower when the ignition switch or ENGINE START/STOP button is in the ON position could cause the battery to discharge. Operate the blower when the engine is running.

Heating and air conditioning automatically

1. Press the AUTO button.
The modes, fan speeds, air intake and air-conditioning will be controlled automatically by setting the temperature.



2. Press the temperature control button to the desired temperature.



* NOTICE

- To turn the automatic operation off, select any button or switch of the following:
 - Mode selection button
 - Air conditioning button
 - Front windscreen defroster button (Press the button one more time to deselect the front windscreen defroster function. The AUTO sign will illuminate on the information display once again.)
 - Fan speed control knob
 The selected function will be controlled manually whilst other functions operate automatically.
- For your convenience and to improve the effectiveness of the climate control, use the AUTO button and set the temperature to 22 °C (72 °F).

Level	Indicator	LCD Display	Air flow
High			1 ~ 8
Medium			1 ~ 7
Low			1 ~ 5

*** NOTICE**

Never place anything over the sensor located on the instrument panel to ensure better control of the heating and cooling system.



Heating and air conditioning manually

The heating and cooling system can be controlled manually by pressing buttons other than the AUTO button.



OMQ4041339R

In this case, the system works sequentially according to the order of buttons selected.

1. Start the vehicle.
2. Set the mode to the desired position.
For improving the effectiveness of heating and cooling;

- Heating:
- Cooling:

3. Set the temperature control to the desired position.
4. Set the air intake control to the outside (fresh) air position.
5. Set the fan speed control to the desired speed.

If air conditioning is desired, turn the air conditioning system on.

Press the AUTO button in order to convert to fully automatic control of the system.

Mode selection

The mode selection button controls the direction of the air flow through the ventilation system.

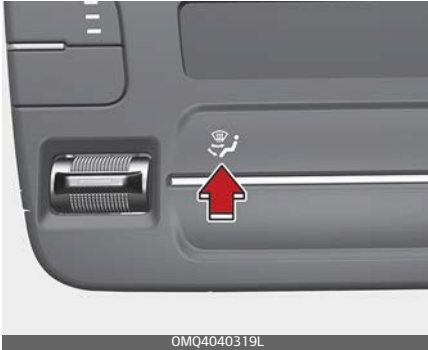

The air flow outlet ports are switched in the following sequence:



Face-Level (B,D,H)

Air flow is directed toward the upper body and face. Additionally, each outlet can be controlled to direct the air discharged from the outlet.

Bi-Level (B,C,D,E,F,H)

Air flow is directed towards the face and the floor.

Floor-Level (A,C,D,E,F,H)

Most of the air flow is directed to the floor, with a small amount of the air being directed to the windscreen, side window defrosters and side air vents.

Floor/Defrost-Level (A,C,D,E,F,H)

Most of the air flow is directed to the floor and the windscreen with a small amount directed to the side window defrosters and side air vents.

Defrost-Level (A,D)

Most of the air flow is directed to the windscreen with a small amount of air directed to the side window defrosters and side air vents.

Instrument panel vents

Front



Centre

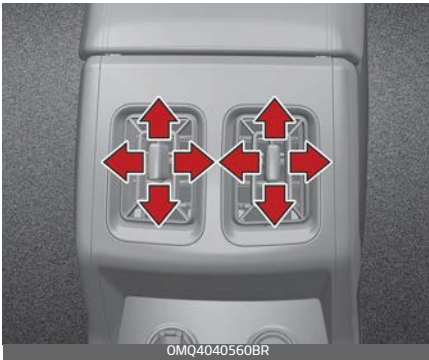

Rear

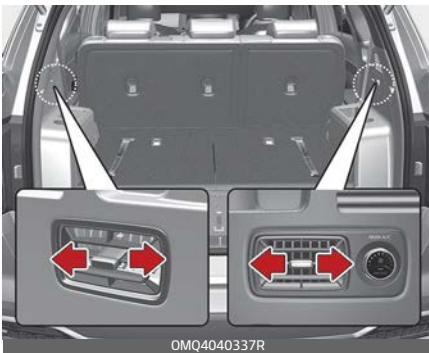

You can adjust the direction of air delivered from these vents using the vent control lever as shown.

Temperature control

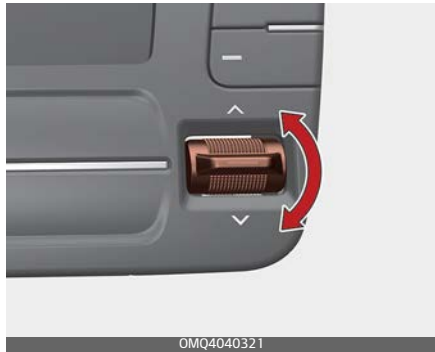

The temperature will increase to the maximum (HI) by moving the switch upwards.

The temperature will decrease to the minimum (Lo) by moving the switch downwards.

When moving the switch, the temperature will increase or decrease by 0.5 °C. When set to the lowest temperature setting, the air conditioning will operate continuously.

Adjusting the driver and passenger side temperature equally



OMQ4040322R

1. Press the "SYNC" button to adjust the driver and passenger side temperature equally. The passenger side temperature will be set to the same temperature as the driver side temperature.
2. Move the driver side temperature control switch. The driver and passenger side temperature will be adjusted equally.
3. If you move the passenger's temperature control switch, the SYNC button is off and the passenger side temperature can be operated individually.

Adjusting the driver and passenger side temperature individually

Press the "SYNC" button again to adjust the driver and passenger side temperature individually. The button indicator will turn off.

Changing temperature scale

You can switch the temperature mode from Centigrade to Fahrenheit as follows:

- Whilst pressing the OFF button, press the AUTO button for 3 seconds or more.

The display will change from Centigrade to Fahrenheit, or from Fahrenheit to Centigrade. If the battery has been discharged or disconnected, the temperature mode display will reset to Centigrade.

Controlling air intake

This is used to select the outside (fresh) air position or recirculated air position.

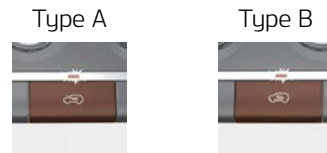

To change the air intake control position:

- Push the desired control button.

Recirculated air position

With the recirculated air position



selected, air from the passenger compartment will be drawn through the heating system and heated or cooled according to the function selected.

Outside (fresh) air position



With the outside (fresh) air position selected, air enters the vehicle from outside and is heated or cooled according to the function selected.

* NOTICE

Prolonged operation of the heater in the recirculated air position (without air conditioning selected) may cause fogging of the windscreen and side windows and the air within the passenger compartment may become stale.

In addition, prolonged use of the air conditioning with the recirculated air position selected will result in excessively dry air in the passenger compartment.

! WARNING

- Continued climate control system operation in the recirculated air position may allow humidity to increase inside the vehicle which may fog the glass and obscure visibility.
- Do not sleep in a vehicle with the air conditioning or heating system on. It may cause serious harm or

death due to a drop in the oxygen level and/or body temperature.

- Continued climate control system operation in the recirculated air position can cause drowsiness or sleepiness, and loss of vehicle control. Set the air intake control to the outside (fresh) air position as much as possible whilst driving.

Controlling fan speed

The fan speed can be set to the desired speed by operating the fan speed control button.

To change the fan speed:

- Press right button for higher speed, or press left button for lower speed.

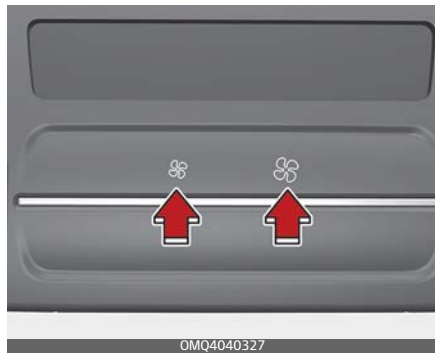

To turn the fan speed control off:

- Press the OFF button.

Air conditioning (A/C)

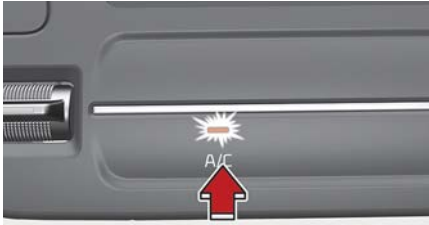

OMQ4040328L

- Press the A/C button to turn the air conditioning system on (indicator light will illuminate).
- Press the button again to turn the air conditioning system off.

Turning off the front air climate control



OMQ4040329R

- Press the OFF button to turn off the air climate control system. However, you can still operate the intake buttons as long as the ENGINE START/STOP button is in the ON position.

Clean air (if equipped)

When the ignition switch or ENGINE START/STOP button is in the ON position, the clean air function turns on automatically.

Also, the clean air function turns off automatically, when the ignition switch or ENGINE START/STOP button is in the OFF position.

3rd row air conditioning (if equipped)



OMQ4H040306L

To turn on the 3rd row air conditioning control system.

1. You can operate the third row air conditioning system from the first row control panel. Changing the front row's fan speed by pressing the control button will automatically change the third row's fan speed as well. When the front row air conditioning has been turned off and you want to stop the A/C in the third row, press the third row air conditioning select button one more time.

Then, the third row's A/C will also turn off.



2. The third row A/C system can be separately controlled by the control buttons in the third row. When the A/C is ON or OFF, the third row A/C control button in the front row will turn ON or OFF, informing the front passengers of the situation.
3. The fan speed of the third row air conditioning can also be separately controlled by turning the fan speed control knob.

Windscreen defrosting and defogging

When the windscreen is covered with frost or moisture, the front view is blurred, you should remove the frost and moisture.

WARNING

Windscreen heating

Do not use the  or  position during cooling operation in extremely humid weather. The difference between the temperature of the outside air and the windscreen could cause the outer surface of the windscreen to fog up, causing loss of visibility. In this case, set the mode selection to the  position and fan speed control to the lower speed.

- For maximum defrosting, set the temperature control to the extreme right/hot position and the fan speed control to the highest speed.
- If warm air to the floor is desired whilst defrosting or defogging, set the mode to the floor-defrost position.
- Before driving, clear all snow and ice from the windscreen, rear window, outside rear view mirrors, and all side windows.

- Clear all snow and ice from the bonnet and air inlet in the cowl grill to improve heater and defroster efficiency and to reduce the probability of fogging up the inside of the windscreen.

Defogging inside windscreen

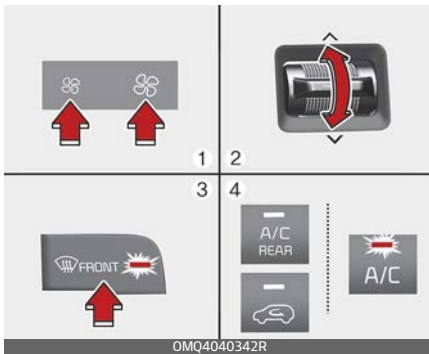

1. Set the fan speed to the desired position.
2. Select desired temperature.
3. Press the defroster button ().
4. The outside (fresh) air position will be selected automatically and the air conditioning will turn on according to the detected ambient temperature.

If the air conditioning and outside (fresh) air position are not selected automatically, adjust the corresponding button manually. If the  position is selected, lower fan speed is adjusted to a higher fan speed.

Defrosting outside windscreen

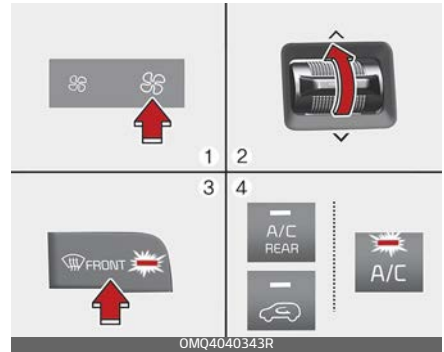

1. Set the fan speed to the highest position.
2. Set the temperature to the extreme hot (HI) position.
3. Press the defroster button ().
4. The outside (fresh) air position will be selected automatically and the air conditioning will turn on according to the detected ambient temperature.

Auto defogging system

Auto defogging helps reduce the possibility of fogging up the inside of the windscreen by automatically sensing the moisture on inside the windscreen.



The auto defogging system operates when the heater or air conditioning is on.

Press the front windscreen defroster button for 3 seconds when the ignition switch or ENGINE START/STOP button is in the ON position.

When the Auto Defogging System is cancelled, ADS OFF symbol will blink 3 times.

When the Auto Defogging System is reset, ADS OFF symbol will blink 6 times without a signal.

*** NOTICE**

- When the air conditioning is turned on by Auto defogging system, if you try to turn off the air conditioning, the indicator will blink 3 times and the air conditioning will not be turned off.
- To maintain the effectiveness and efficiency of the Auto Defogging System, do not select Recircula-

- tion mode whilst the system is operating.
- When the Auto Defogging System is operating, the fan speed adjustment knob, the temperature adjustment knob, and the air intake control button are all disabled.

*** NOTICE**

Do not remove the sensor cover located on the upper end of the driver side windscreen glass. Damage to system parts could occur and may not be covered by your vehicle warranty.

Defroster

The vehicle is equipped with a defroster for removing frost or fog from the rear window.

⚠ CAUTION

Conductors

To prevent damage to the conductors bonded to the inside surface of the rear window, never use sharp instruments or window cleaners containing abrasives to clean the window.

If you want to defrost and defog the front windscreen, refer to "Windscreen defrosting and defogging" on page 5-172.

Operating rear window defroster

The defroster heats the window to remove frost, fog and thin ice from the rear window, whilst the engine is on.

If there is heavy accumulation of snow on the rear window, brush it off before operating the rear defroster.



To activate the rear window defroster:

- Press the rear window defroster button located in the heater control panel. The indicator on the rear window defroster button illuminates when the defroster is ON. The rear window defroster automatically turns off after approximately 20 minutes or when the ENGINE START/STOP button is turned off.



To turn off the defroster:

- Press the rear window defroster button again.

Outside mirror defroster (if equipped)

If your vehicle is equipped with the outside mirror defrosters, they will operate at the same time you turn on the rear window defroster.

Defogging logic (if equipped)

To reduce the possibility of fogging up the inside of the windscreen, the air intake or air conditioning is controlled automatically according to certain conditions such as  or  position.

To cancel automatic defogging logic or return to the automatic defogging logic, do the following.

Cancelling/returning automatic defogging logic

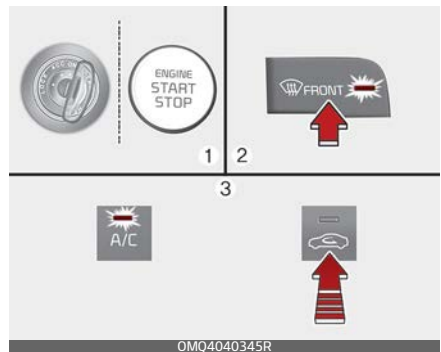

1. Turn the ENGINE START/STOP button to the ON position.
2. Press the defroster button ().
3. Whilst pressing the air conditioning (A/C) button, press the air conditioning (A/C) button.

intake control button at least 5 times within 3 seconds.

The recirculation indicator blinks 3 times in 0.5 second of intervals. It indicates that the defogging logic is cancelled or returned to the programmed status.

If the battery has been discharged or disconnected, it resets to the defog logic status.

Storage compartment

These compartments can be used to store small items required by the driver or passengers.

CAUTION

- To avoid possible theft, do not leave valuables in the storage compartment.
- Always keep the storage compartment covers closed whilst driving. Do not attempt to place so many items in the storage compartment that the storage compartment cover cannot close securely.

WARNING

Flammable materials

Do not store glasses, gas lighter, portable battery, canned beverage, spray can, propane cylinder, cosmetic tube or other flammable/explosive materials in the vehicle. These items may catch fire and/or explode if the vehicle is exposed to hot temperatures for extended periods.

Centre console storage



To open the centre console storage:

- Pull up the lever.

Glove box

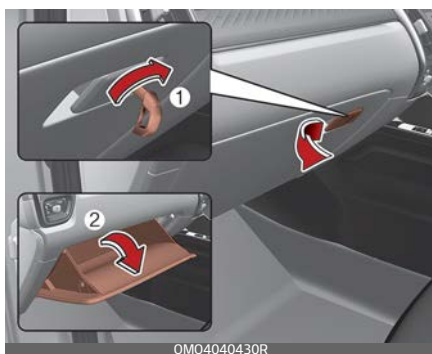

The glove box can be locked and unlocked with the mechanical key (1).

To open the glove box:

- Pull the handle and the glove box will automatically open (2).

Close the glove box after use.

⚠ WARNING

Glove box

To reduce the risk of injury in an accident or sudden stop, always keep the glove box door closed whilst driving.

⚠ CAUTION

Do not keep food in the glove box for a long time.

Interior features

There are various features inside the vehicle for the convenience of the occupants.

Ambient light (if equipped)

The ambient lights are applied to the front passenger's crash pad and front door.



When the headlamp light is on, the ambient light is on at the same time could be set in the infotainment menu.

Refer to the infotainment manual for details.

Ashtray (if equipped)



- To use the ashtray, open the cover.
- To clean or empty the ashtray, pull it out.

Use the ashtray by leaning it to the cup holder right beside.

⚠ WARNING

Ashtray use

- Do not use the vehicle's ashtrays as waste receptacles.
- Putting lit cigarettes or matches in an ashtray with other combustible materials may cause a fire.

Cup holder

Front



Rear





Cups or small beverage cans may be placed in the cup holders.

⚠ WARNING

Hot liquids

- Do not place uncovered cups with hot liquid in the cup holder whilst the vehicle is in motion. If the hot liquid spills, you burn yourself. Such a burn to the driver could lead to loss of control of the vehicle.
- To reduce the risk of personal injury in the event of sudden stop or collision, do not place uncovered or unsecured bottles, glasses, cans, etc., in the cup holder whilst the vehicle is in motion.

⚠ WARNING

Keep cans or bottles out of direct sun light and do not put them in a vehicle that is heated up. It may explode.

*** NOTICE**

- Keep your drinks sealed whilst driving to prevent spilling your drink. If liquid spills, it may get into the vehicle's electrical/electronic system and damage electrical/ electronic parts.
- When cleaning spilled liquids, do not dry the cup holder at high temperature. This may damage the cup holder.

Seat warmer (if equipped)

The seat warmer is provided to warm the front seats during cold weather.

Front seat



Rear seat



With the ignition switch or ENGINE START/STOP button in the ON position:

- Push either of the levers/switch to warm the driver's seat or the front passenger's seat.

During mild weather or under conditions where the operation of the seat warmer is not needed, keep the levers/switch in the "OFF" position.

Temperature control (Manual)

- Each time you press the levers/switch, the temperature setting of the seat will change as follows:
 - Front seat



- Rear seat

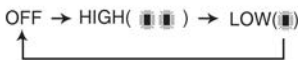

- The seat warmer defaults to the OFF position whenever the ignition switch or ENGINE START/STOP button is turned on.

Temperature control (Automatic)

The seat warmer starts to automatically control the seat temperature in order to prevent low-temperature burns after being manually turned ON.

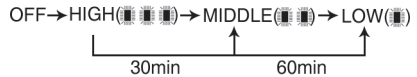

You may manually press the button to increase the seat temperature. However, it soon returns to the automatic mode again.

- When pressing the levers/switch for more than 1.5 seconds with the seat warmer operating, the seat warmer will turn OFF.
- The seat warmer defaults to the OFF position whenever the ENGINE START/STOP button is in the ON position.

*** NOTICE**

With the seat warmer levers/switch in the ON position, the heating system in the seat turns off or on automatically depending on the seat temperature.

⚠ CAUTION

- When cleaning the seats, do not use an organic solvent such as paint thinner, benzene, alcohol and petrol. Doing so may damage the surface of the heater or seats.
- To prevent overheating the seat warmer, do not place anything on the seats that insulates against heat, such as blankets, cushions or seat covers whilst the seat warmer is in operation.
- Do not place heavy or sharp objects on seats equipped with seat warmers. Damage to the seat warming components could occur.
- Do not change the seat cover. It may damage the seat warmer or air ventilation system.

⚠ WARNING

Seat warmer burns

Passengers should use extreme caution when using seat warmers due to the possibility of excess heating or burns. The seat warmer may cause burns even at low temperatures, especially if used for long periods of time. In particular, the driver must exercise extreme care for the following types of passengers:

1. Infants, children, elderly or handi-capped persons, or hospital out-patients
2. Persons with sensitive skin or those that burn easily
3. Fatigued individuals
4. Intoxicated individuals
5. Individuals taking medication that can cause drowsiness or sleepiness (sleeping pills, cold tablets, etc.)

Air ventilation seat (if equipped)



The temperature setting of the seat changes according to the levers position.

- To ventilate your seat cushion, push the levers. Each time you push the levers, the airflow will change as follows:

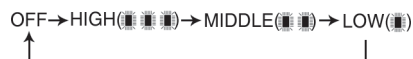

The seat warmer (with air ventilation) defaults to the OFF position

whenever the ENGINE START/STOP button is turned on.

⚠ CAUTION

Seat damage

- When cleaning the seats, do not use an organic solvent such as paint thinner, benzene, alcohol and petrol. Doing so may damage the air ventilation seat.

Sun visor

Use the sun visor to shield direct light through the front or side windows.

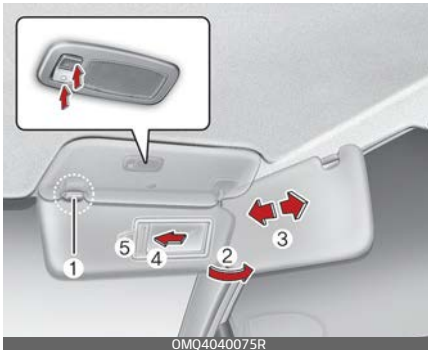

- To use the sun visor, pull it downward.
- To use the sun visor for the side window, pull it downward, unsnap it from the bracket (1) and swing it to the side (2). You can slide the sun visor if necessary (3) (if equipped).
- To use the vanity mirror, pull down the visor and slide the mirror cover (4).

Press the ON button (☀) to turn on the lamp inside the sun visor when using a mirror. Before returning the sun visor to the original position, be sure to press the OFF button (○) to turn it off. The ticket holder (5) is provided for holding a tollgate ticket.

⚠ WARNING

For your safety, do not block your view when using the sun visor.

* NOTICE

Do not put several tickets in the ticket holder at one time. This could cause damage to the ticket holder.

USB charger (if equipped)

The USB car charger allows drivers to charge their digital devices like smart phones, and PC tablets.

Front



2nd row (if equipped)



Seat (if equipped)

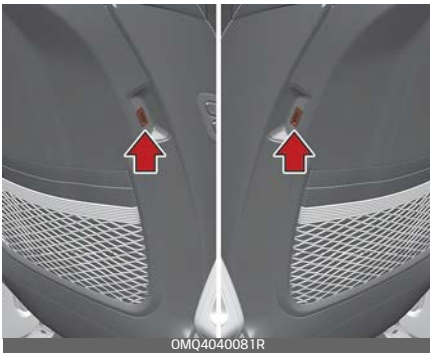

3rd row (if equipped)



Plug the cable into the USB port, and charging will begin.

The USB car charger is available with either the ACC on or the ignition on. We recommend you connect the USB port and digital devices with the engine running. See the display screen of the device to check its charging process completion. Your smartphone or table PC could get heated up whilst charging. This is no reason to worry, as it doesn't impact life or functions of the device. For the safety reason, charging can be stopped if the battery gets heated up to a certain point of temperature that the devices can be negatively affected. Charging some digital devices is not available or requires special dedicated adapters if their charging methods don't fit the way the USB car charger works. Quick Charge 2.0 is available on the smart phone or the table PC equipped with fast charging capabilities. The applicable is as follows: (<https://www.qualcomm.com/documents/quick-charge-device-list>)

The smart phone or PC tablet without fast charging is charged at a regular speed.

Rated output:

- Digital devices with fast charging:
 - 9.0 V, 1.67 A
- Digital devices with normal charging:
 - 5.0 V, 2.1 A

⚠ CAUTION

- Use the USB car charger with the ignition on. Otherwise, Vehicle battery can be discharged.
- Use the official USB cable of the manufacturer of the digital device to be charged.
- Make sure that any foreign object, drinks, and water do not come into contact with the USB car charger. Water or foreign object can damage the USB charger.
- Do not use the device those current consumption exceeds 2.1 A.
- Do not connect an electrical device that generates excessive electromagnetic noise to the USB car port. If you do so, noise can be caused or vehicle electronic devices can be interrupted whilst audio or AV is on.
- If the charger is connected incorrectly, it can cause serious damage on the devices. Please note that damages due to incorrect usage are not covered by warranty service.

Power outlet (if equipped)

The power outlet is designed to provide power for mobile telephones or other devices designed to operate with vehicle electrical systems.

2nd row



3rd row

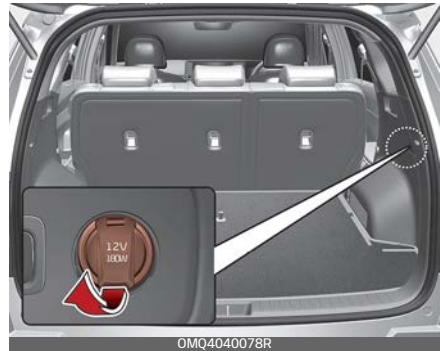

The devices should draw less than 15 amps with the vehicle on.

⚠ WARNING

- Use the power outlet only when the vehicle is on and remove the accessory plug after use. Using the accessory plug for prolonged periods of time with the vehicle off could cause the battery to discharge.
- Only use 12 V electric accessories which are less than 15 A in electric capacity.
- Adjust the air-conditioner or heater to the lowest operating level when using the power outlet.
- Close the cover when not in use.
- Some electronic devices can cause electronic interference when plugged into a vehicle's power outlet. These devices may cause excessive audio static and malfunctions in other electronic systems or devices used in your vehicle.
- Push the plug in as far as it will go. If good contact is not made, the plug may overheat and the fuse may open.
- Plug in battery equipped electronic devices with reverse current protection. The current from the battery may flow into the vehicle's electrical/electronic system and cause system malfunction.

⚠ WARNING**Electric shock**

Do not put a finger or a foreign object (pen, etc.) into a power outlet and do not touch with a wet hand. You may get an electric shock.

Wireless smart phone charging system (if equipped)

A wireless smart phone charging system is located in front of the centre console.



[A]: Indicator, [B]: Charging pad

Firmly close all doors, and the ignition switch or ENGINE START/STOP button is ON. To start wireless charging, place the smart phone equipped with wireless charging function on the wireless charging pad.

For best wireless charging results, place the smart phone on the centre of the charging pad.

The wireless charging system is designed for one smart phone equipped with Qi only. Please refer to the smart phone accessory cover or the smart phone manufacturer homepage to check whether your smart phone supports Qi function.

▲ WARNING

If any metallic object such as coins is located between the wireless charging system and the smart phone, the charging may be disrupted. Also, the metallic object may heat up.

Wireless smart phone charging

1. Remove any object on the smart phone charging pad including the smart key. If there is any foreign object on the pad other than a smart phone, the wireless charging function may not operate properly.
2. Place the smart phone on the centre of the wireless charging pad.
3. The indicator light will change to orange once the wireless charging begins. After the charging is complete, the orange light will change to green.
4. You can choose to turn the wireless charging function to either ON or OFF by selecting the USM on the instrument cluster. (Please refer to "Instrument cluster" on page 5-71 for details).

If the wireless charging does not work, gently move your smart phone around the pad until the charging indicator light turns yellow. Depending on the smart phone, the charging indicator light may not turn green even after the charging is complete.

If the wireless charging is not functioning properly, the orange light will blink and flash for ten seconds then turn off. In such cases, remove the smart phone from the pad and replace it on the pad again, or double check the charging status.

If you leave the smart phone on the charging pad when the vehicle ignition is in OFF, the vehicle will alert you through warning messages and sound (applicable for vehicles with voice guidance function) after the 'Good bye' function on the instrument cluster ends.

*** NOTICE**

For some manufacturers' smart phones, the system may not warn you even though the smart phone is left on the wireless charging unit. This is due to the particular characteristic of the smart phone and not a malfunction of the wireless charging.

⚠ CAUTION

- When the interior temperature of the wireless charging system rises above a set temperature, the wireless charging will cease to function. After the interior temperature drops below the threshold, the wireless charging function will resume.
- If there is any metallic object between the smart phone and the wireless charging pad, immediately remove the smart phone. Remove the metallic object after it has completely cooled down.
- The wireless charging may not function properly when there is a heavy accessory cover on the smart phone.
- The wireless charging will stop when using the wireless smart key search function to prevent radio wave disruption.
- The wireless charging will stop when the smart key is moved out of the vehicle with the ignition in ON.
- The wireless charging will stop when any of the doors is opened (applicable for vehicles equipped with smart keys).
- The wireless charging will stop when the vehicle is turned OFF.
- The wireless charging will stop when the smart phone is not in complete contact with the wireless charging pad.
- Items equipped with magnetic components such as credit card, telephone card, bankbook, any transportation ticket and such may become damaged during wireless charging.
- Place the smart phone on the centre of the charge pad for best results. The smart phone may not charge when placed near the rim of the charging pad. When the smart phone does get charged, it may heat up excessively.
- For smart phones without built-in wireless charging system, an appropriate accessory has to be equipped.
- Smart phones of some manufacturers may display messages on weak current. This is due to the particular characteristic of the smart phone and does not imply a malfunction on wireless charging function.
- The indicator light of some manufacturers' smart phones may still be yellow after the smart phone is fully charged. This is due to the particular characteristic of the smart phone and not a malfunction of the wireless charging.
- When any smart phone without a wireless charging function or a metallic object is placed on the charging pad, a small noise may sound. This small sound is due to the vehicle discerning compatibility of the object placed on the

charging pad. It does not affect your vehicle or the smart phone in any way.

- The wireless mobile phone charging system may not support certain mobile phones, which are not verified for the Qi specification (Qi).
- For certain mobile phones with their own protection, the wireless charging speed may decrease and the wireless charging may stop.

Coat hook

A Coat hook is next to the rear grab handle.



* This actual feature may differ from the illustration.

⚠ CAUTION

Hanging clothing

Do not hang heavy clothes, since they may damage the hook.

⚠ WARNING

Do not hang other objects such as hangers or hard objects except clothes. Also, do not put heavy, sharp or breakable objects in the clothing's pockets. In an accident or when the curtain air bag is inflated, it may cause vehicle damage or body injury.



Side curtain (if equipped)

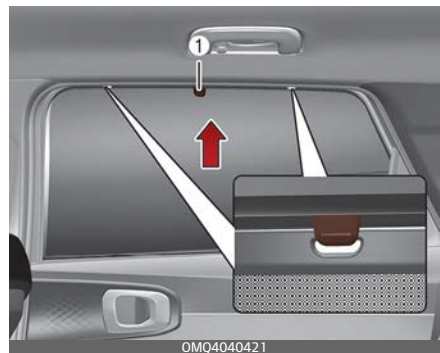

To use the side curtain:

1. Lift the curtain by the knob (1).
2. Hang the curtain on both sides of the hook.

* NOTICE

- Always hang both sides of the curtain on the hook. This could cause damage to the side curtain if only one side of the curtain is hooked.
- Do not let any foreign material get in between the door trim and side curtain. The side curtain may not be lifted up.

Floor mat anchors (if equipped)

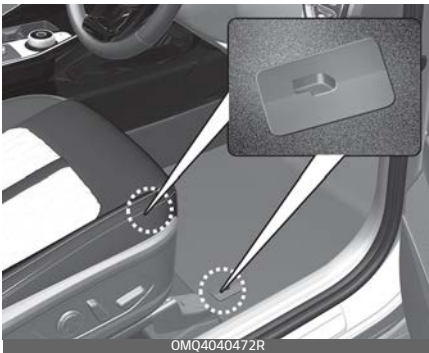

When using a floor mat on the front floor carpet, make sure it attaches to the floor mat anchors in your vehicle. This keeps the floor mat from sliding forward.

⚠ WARNING

After market floor mat

Do not install after market floor mats that are not capable of being securely attached to the vehicle's floor mat anchors.

Unsecured floor mats can interfere with pedal operation.

The following must be observed when installing ANY floor mat to the vehicle.

- Ensure that the floor mats are securely attached to the vehicle's floor mat anchor(s) before driving the vehicle.
- Do not use ANY floor mat that cannot be firmly attached to the vehicle's floor mat anchors.
- Do not stack floor mats on top of one another (e.g., all-weather rubber mat on top of a carpeted floor mat). Only a single floor mat should be installed in each position.

Luggage net holder

To keep items from shifting in the cargo area, you can use the 4 holders located in the cargo area to attach the luggage net (if equipped), or you can fold the luggage net into half and attach it upwards by using the additional 2 holders located on each side.



If necessary, Kia recommends to contact an authorised Kia dealer/ service partner.

⚠ CAUTION

To prevent damage to the goods or the vehicle, care should be taken when carrying fragile or bulky objects in the luggage compartment.

⚠ WARNING

Avoid eye injury. DO NOT over-stretch the luggage net, ALWAYS keep your face and body out of the

luggage net's recoil path. DO NOT use when the strap has visible signs of wear or damage.

Cargo security screen (if equipped)

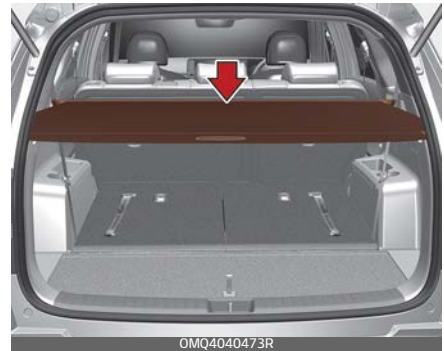

Use the cargo security screen to hide items stored in the cargo area.

*** NOTICE**

Since the cargo security screen may be damaged or malformed, do not put luggage on it when it is used.

⚠ WARNING

- Do not place objects on the cargo security screen. Such objects may move around inside the vehicle and possibly injure vehicle occupants during an accident or when braking.
- Never allow anyone to ride in the luggage compartment. It is designed for luggage only.

- Maintain the balance of the vehicle and locate the weight as forward as possible.

To use the cargo security screen



OMQ4PH040502R

1. Pull the cargo security screen towards the rear of the vehicle by the handle (1).
2. Insert the guide pin into the guide (2).

*** NOTICE**

Pull out the cargo security screen using the handle in the centre to prevent the guide pin from falling out of the guide.

When the cargo security screen is not in use:

1. Pull the cargo security screen backward and up to release it from the guides.
2. The cargo security screen will automatically slide back in.

*** NOTICE**

The cargo security screen may not automatically slide back in if the cargo security screen is not fully pulled out. Fully pull it out and then let go.

To remove the cargo security screen

1. Push the guide pin in the direction as shown in the picture below.



OMQ4040475R

2. Whilst pushing the guide pin, pull out the cargo security screen.
3. Keep the cargo security screen in the guide pin above the tray.



OMQ4PH040590L

Luggage board

You can place a first aid kit, a reflector triangle, tools, etc. in the box for easy access.



1. Grasp the handle on the top of the cover and lift it.
2. Fold the rear part of luggage board forward.
3. Lift up upward luggage board forward (Luggage board)

Luggage tray (if equipped)

You can place a first aid kit, a reflector triangle (front tray), tools, etc. in the box for easy access.

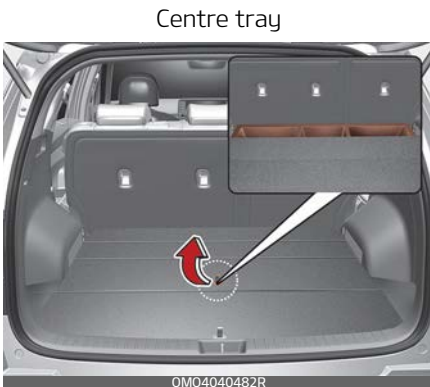

Front tray (for hybrid vehicle)



Front tray (for plug-in hybrid vehicle)



- Grasp the handle on the top of the cover and lift it.

Luggage side tray (if equipped)

The luggage side tray can be used for storing small items.

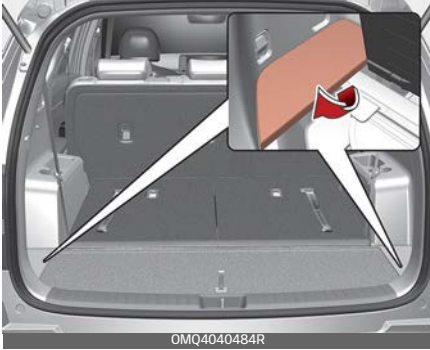

- To open the cover, pull up the handle and lift the cover.

Exterior features

Roof rack (if equipped)

If the vehicle has a roof rack, you can load cargo on top of your vehicle.



Crossbars and fixing components needed to install the roof rack on your vehicle may be obtained from an authorised Kia dealer/service partner or other qualified shop.

* NOTICE

- The crossbars (if equipped) should be placed in the proper load carrying positions prior to placing items onto the roof rack.
- If the vehicle is equipped with a sunroof, be sure not to position cargo onto the roof rack in such a way that it could interfere with sunroof operation.
- When the roof rack is not being used to carry cargo, the crossbars

may need to be repositioned if wind noise is detected.

⚠ CAUTION

- When carrying cargo on the roof rack, take the necessary precautions to make sure the cargo does not damage the roof of the vehicle.
- When carrying large objects on the roof rack, make sure they do not exceed the overall roof length or width.
- When you are carrying cargo on the roof rack, do not operate the sunroof. (if equipped)

⚠ WARNING

- The following specification is the maximum weight that can be loaded onto the roof rack. Distribute the load as evenly as possible across the crossbars (if equipped) and roof rack and secure the load firmly.

ROOF RACK	100 kg (220 lbs.) EVENLY DISTRIBUTED
-----------	-----------------------------------------

Loading cargo or luggage in excess of the specified weight limit on the roof rack may damage your vehicle.

- The vehicle centre of gravity will be higher when items are loaded onto the roof rack. Avoid sudden starts, braking, sharp turns,

abrupt manoeuvres or high speeds that may result in loss of vehicle control or rollover resulting in an accident.

- Always drive slowly and turn corners carefully when carrying items on the roof rack. Severe wind updrafts, caused by passing vehicles or natural causes, can cause sudden upward pressure on items loaded on the roof rack. This is especially true when carrying large, flat items such as wood panels or mattresses. This could cause the items to fall off the roof rack and cause damage to your vehicle or others around you.
- To prevent damage or loss of cargo whilst driving, check frequently before or whilst driving to make sure the items on the roof rack are securely fastened.

Infotainment system

Audio system

* NOTICE

If you install an aftermarket HID head lamp, your vehicle's audio and electronic device may malfunction.

* If your vehicle is equipped with infotainment system, refer to a separately supplied manual for detailed information.

Antenna

Type A



Type B



1. Shark fin antenna (Type A, if equipped)
The roof antenna transmits and receives wireless signals such as AM/FM, DAB, GNSS, LTE etc.
2. Pole antenna (Type B, if equipped)
Your vehicle uses a pole type antenna to receive both AM and FM signals.

* The signals which antenna can transmit and receive vary by the vehicle option.

* NOTICE

- Avoid adding metallic coatings such as Ni, Cd, etc. These can degrade the receiving AM and FM broadcast signals.

USB port

You can use the USB port to plug in a USB.

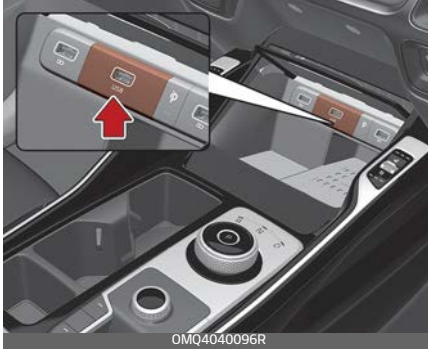

⚠ CAUTION

Depending on the size, length, or shape of the USB stick, if you forcibly close the tray cover, the USB device may be damaged or deformed or the cover may not reopen as the device is stuck.

When the stick is stuck, forcibly opening the cover can also cause damage to the device.

If the USB stick does not fit into the space, do not close the cover and try another USB stick with different specifications.

How vehicle radio works

FM reception

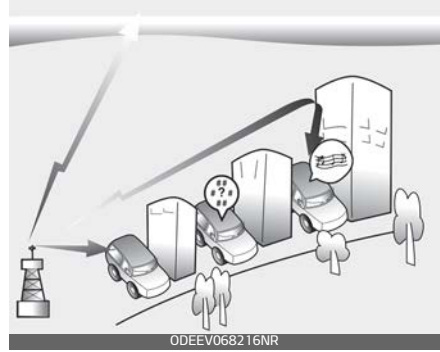

AM and FM radio signals are broadcast from transmitter towers located around your city. They are intercepted by the radio antenna on your vehicle. This signal is then processed by the radio and sent to your vehicle speakers.

However, in some cases the signal coming to your vehicle may not be strong and clear.

This can be due to factors, such as the distance from the radio station, closeness of other strong radio stations or the presence of buildings, bridges or other large obstructions in the area.

AM reception

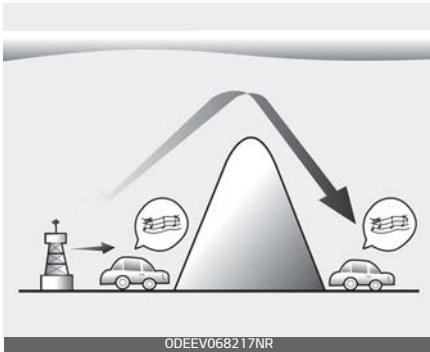

AM broadcasts can be received at greater distances than FM broadcasts. This is because AM radio waves are transmitted at low frequencies. These long distance, low frequency radio waves can follow the curvature of the earth rather than travelling straight. In addition, they curve around obstructions resulting in better signal coverage.

FM radio station

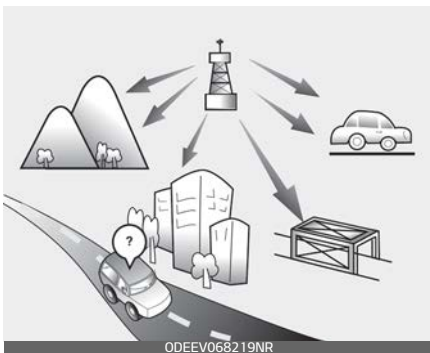

FM broadcasts are transmitted at high frequencies and do not bend to follow the earth's surface. Because

of this, FM broadcasts generally begin to fade within short distances from the station. Also, FM signals are easily affected by buildings, mountains, and obstructions. This can lead to undesirable or unpleasant listening conditions which might lead you to believe a problem exists with your radio.

The following conditions are normal and do not indicate radio trouble:

- Fading - As your vehicle moves away from the radio station, the signal will weaken and sound will begin to fade. When this occurs, we suggest that you select another station with a stronger signal.

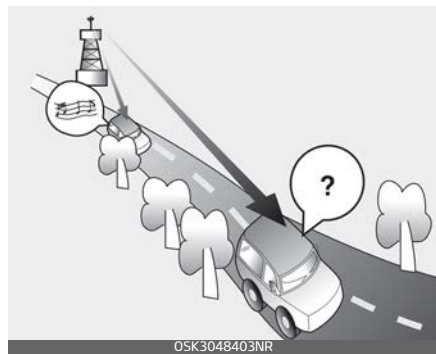

- Flutter/Static - Weak FM signals or large obstructions between the transmitter and your radio can disturb the signal causing static or fluttering noises to occur. Reducing the treble level may lessen this effect until the disturbance clears.

- **Station Swapping** – As an FM signal weakens, another more powerful signal near the same frequency may begin to play. This is because your radio is designed to lock onto the clearest signal. If this occurs, select another station with a stronger signal.

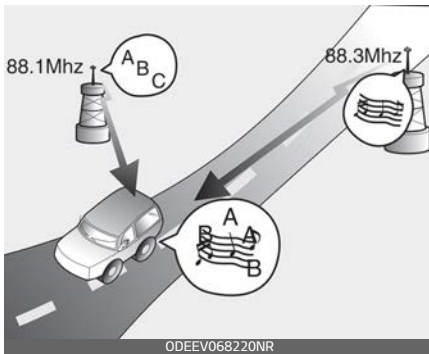

- **Multi-Path Cancellation** – Radio signals being received from several directions can cause distortion or fluttering. This can be caused by a direct and reflected signal from the same station, or by signals from two stations with close frequencies. If this occurs, select another station until the condition has passed.

Using a mobile phone or a two-way radio

When a mobile phone is used inside the vehicle, noise may be produced from the audio system. This does not mean that something is wrong with the audio equipment. In such a case, try to operate mobile devices as far from the audio equipment as possible.

⚠ CAUTION

When using a communication system such as a mobile phone or a radio set inside the vehicle, a separate external antenna must be fitted. When a mobile phone or a radio set is used with only the internal antenna, it may interfere with the vehicle's electrical system and adversely affect the safe operation of the vehicle.

⚠ WARNING

Cell phone use

Do not use a mobile phone whilst driving. Stop at a safe location to use a mobile phone.

Be sure the exhaust system does not leak.	6-6
Before driving	6-6
Key positions	6-8
• Illuminated ignition switch	6-8
• Ignition switch position.....	6-9
• Starting the engine	6-10
ENGINE START/STOP button	6-12
• Illuminated ENGINE START/STOP button	6-12
• ENGINE START/STOP button position.....	6-12
• Starting the engine	6-14
Automatic transmission (Dial SBW)	6-17
• Automatic transmission operation	6-17
• LCD display messages	6-21
• Paddle shifter	6-24
• Good driving practices	6-24
All Wheel Drive (AWD) system	6-26
• AWD (AWD/TERRAIN MODE).....	6-27
• For safe All Wheel Drive (AWD) operation.....	6-29
Brake system	6-35
• Power brakes	6-35
• Electronic Parking Brake (EPB)	6-37
• AUTO HOLD.....	6-43
• Anti-lock Brake System (ABS)	6-46
• Electronic Stability Control (ESC) system	6-48
• Downhill Brake Control (DBC)	6-51
• Hill-start Assist Control (HAC)	6-53
• Multi-Collision Brake (MCB)	6-53
• Vehicle Stability Management (VSM) system	6-54

6 Driving your vehicle

• Emergency Stop Signal (ESS)	6-56
• Trailer Stability Assist (TSA) system	6-56
• Brake Assistant System (BAS)	6-57
• Good braking practices	6-57
Drive mode integrated control system	6-59
• Drive mode	6-59
• Smart shift on trip computer	6-63
Forward Collision-Avoidance Assist (FCA) (Front view camera only)	6-65
• Forward Collision-Avoidance Assist settings	6-66
• Forward Collision-Avoidance Assist Operation	6-68
• Forward Collision-Avoidance Assist Malfunction and Limitations	6-71
Forward Collision-Avoidance Assist (FCA) (Sensor fusion)	6-78
• Forward Collision-Avoidance Assist Settings	6-79
• Forward Collision-Avoidance Assist Operation	6-81
• Forward Collision-Avoidance Assist Malfunction and Limitations	6-86
Lane Keeping Assist (LKA)	6-94
• Lane Keeping Assist Settings	6-94
• Function operation	6-96
• Lane Keeping Assist Malfunction and Limitations	6-98
Blind-Spot Collision-Avoidance Assist (BCA)	6-101
• Blind-Spot Collision-Avoidance Assist Settings	6-103
• Blind-Spot Collision-Avoidance Assist Operation	6-105
• Blind-Spot Collision-Avoidance Assist Malfunction and Limitations	6-109

Safe Exit Warning (SEW)	6-114
• Safe Exit Warning Settings	6-115
• Safe Exit Warning Operation	6-116
Safe Exit Assist (SEA)	6-118
• Safe Exit Assist Settings	6-119
• Function operation	6-120
• Safe Exit Assist Malfunction and Limitations	6-122
Manual Speed Limit Assist (MSLA)	6-124
• Function operation	6-124
Intelligent Speed Limit Assist (ISLA)	6-127
• Intelligent Speed Limit Assist Settings	6-127
• Function operation	6-128
• Intelligent Speed Limit Assist Malfunction and Limitations	6-130
Driver Attention Warning (DAW)	6-133
• Driver Attention Warning Settings	6-133
• Function operation	6-135
• Driver Attention Warning Malfunction and Limitations	6-137
Blind-Spot View Monitor (BVM)	6-140
• Blind-Spot View Monitor Settings	6-141
• Blind-Spot View Monitor Operation	6-142
• Blind-Spot View Monitor Malfunction	6-142
Cruise Control (CC)	6-142
• Cruise Control Operation	6-143
Smart Cruise Control (SCC)	6-146
• Function settings	6-147
• Smart Cruise Control Operation	6-151

6 Driving your vehicle

- Smart Cruise Control Malfunction and Limitations..... 6-157
- Navigation-based Smart Cruise Control (NSCC)..... 6-163**
- Navigation-based Smart Cruise Control settings 6-163
- Navigation-based Smart Cruise Control operation 6-164
- Limitations..... 6-166
- Lane Following Assist (LFA)..... 6-169**
- Function settings..... 6-170
- Lane Following Assist Operation..... 6-171
- Lane Following Assist Malfunction and Limitations.... 6-173
- Highway Driving Assist (HDA)..... 6-173**
- Highway Driving Assist Settings 6-174
- Highway Driving Assist Operation Function operation 6-175
- Highway Driving Assist Malfunction and Limitations 6-177
- Rear Cross-Traffic Collision-Avoidance Assist (RCCA) .. 6-180**
- Rear Cross-Traffic Collision- Avoidance Assist Settings 6-181
- Rear Cross-Traffic Collision- Avoidance Assist Operation 6-182
- Rear Cross-Traffic Collision- Avoidance Assist Malfunction and Limitations 6-186
- Reverse Parking Collision-Avoidance Assist (PCA)..... 6-191**
- Reverse Parking Distance Warning Settings..... 6-192
- Reverse Parking Distance Warning Operation..... 6-193
- Reverse Parking Distance Warning Malfunction and Limitations 6-194
- Remote Smart Parking Assist (RSPA) 6-198**
- Remote Smart Parking Assist Settings 6-201

• Remote Smart Parking Assist Operation	6-203
• Remote Smart Parking Assist operation status	6-208
• Remote Smart Parking Assist Malfunction and limitations	6-209
Declaration of conformity	6-213
Economical operation	6-219
Special driving conditions	6-220
Winter driving	6-225
Trailer towing (if equipped)	6-230
• Hitches	6-231
• Safety chains	6-232
• Trailer brakes	6-232
• Driving with a trailer	6-233
• Maintenance when trailer towing	6-236
• If you do decide to pull a trailer	6-236
Vehicle weight	6-241
• Base kerb weight.....	6-241
• Vehicle kerb weight.....	6-241
• Cargo weight	6-241
• GAW (Gross axle weight).....	6-242
• GAWR (Gross axle weight rating)	6-242
• GVW (Gross vehicle weight)	6-242
• GVWR (Gross vehicle weight rating)	6-242
• Overloading.....	6-242
• Loading Your Vehicle - For Australia.....	6-242

Driving your vehicle

Be sure the exhaust system does not leak.

The exhaust system should be checked whenever the vehicle is raised to change the oil or for any other purpose.

If you hear a change in the sound of the exhaust or if you drive over something that st

rikes the underneath side of the vehicle, have the exhaust system checked as soon as possible by a professional workshop. Kia recommends to visit an authorised Kia dealer/service partner.

WARNING

Engine exhaust

Do not inhale exhaust fumes or leave your engine running in an enclosed area for a prolonged time. Exhaust fumes contain carbon monoxide, a colourless and odourless gas that can cause unconsciousness and death by asphyxiation.

Before driving

Before getting into the vehicle, you should examine the vehicle and its surroundings. After getting into the vehicle, you should check a number of things before driving.

Before entering vehicle

- Be sure that all windows, outside mirror(s), and outside lights are clean.
- Check the condition of the tyres.
- Check under the vehicle for any sign of leaks.
- Be sure there are no obstacles behind you if you intend to back up.

Necessary inspections

Fluid levels, such as engine oil, engine coolant, brake fluid, and washer fluid should be checked on a regular basis, at the exact interval depending on the fluid. Further details are provided in "Maintenance" on page 8-5.

WARNING

Distracted driving

Focus on the road whilst driving. The driver's primary responsibility is in the safe and legal operation of a vehicle. Any use of handheld devices, other equipment, or vehicle systems that take the driver's eyes, attention, and focus away from the

safe operation of a vehicle are not permissible by law. These should never be used during the operation of the vehicle.

Before starting

- Close and lock all doors.
- Position the seat so that all controls are easily reached.
- Buckle your seat belt.
- Adjust the inside and outside rear view mirrors.
- Be sure that all lights work.
- Check all gauges.
- Check the operation of warning lights when the ENGINE START/STOP button is turned to the ON position.
- Release the parking brake and make sure the brake warning light is not on.

For safe operation, be sure you are familiar with your vehicle and its equipment.

⚠ WARNING

When you intend to park or stop the vehicle with the engine on, be careful not to depress the accelerator pedal for a long period of time. It may overheat the engine or exhaust system and cause fire.

⚠ WARNING

Check surroundings

Always check the surrounding areas near your vehicle for people, especially children, before putting a vehicle into D (Drive) or R (Reverse).

⚠ WARNING

Loose objects

Securely store items in your vehicle. When you make a sudden stop or turn the steering wheel rapidly, loose objects may drop on the floor and it could interfere with the operation of the foot pedals, possibly causing an accident.

⚠ WARNING

Driving under the influence

Do not drive whilst under the influence of alcohol, drugs, or other impairing substances. Drinking and driving is dangerous. Even a small amount of alcohol will affect your reflexes, perceptions and judgment. Driving whilst under the influence of drugs or other impairing substances is as dangerous as or more dangerous than driving drunk.

⚠ WARNING**Proper footwear**

Always wear appropriate shoes when operating your vehicle. Unsuitable shoes (high heels, ski boots, sandals, etc.) may interfere with your ability to use the brake and accelerator pedals.

Key positions (if equipped)

Your vehicle is equipped with four different ignition positions.

Illuminated ignition switch

Whenever a front door is opened, the ignition switch will illuminate for your convenience, provided the ignition switch is not in the ON position.



The light will go off immediately when the ignition switch is turned on. It will also go off after about 30 seconds when the door is closed.

Ignition switch position

Your vehicle is equipped with four different ignition positions.



LOCK (1)

The ignition key can be removed only in the LOCK position.

ACC (Accessory) (2)

The electrical accessories are operative. If difficulty is experienced turning the ignition switch to the ACC position, turn the key whilst turning the steering wheel right and left to release the tension.

ON (3)

The warning lights can be checked before the engine is started. This is the normal running position after the engine is started.

Do not leave the ignition switch ON if the engine is not running to prevent battery discharge.

START (4)

Turn the ignition switch to the START position to start the engine. The engine will crank until you release the key; then it returns to the ON position. The brake warning light can be checked in this position.

⚠ WARNING

Ignition switch

Never turn the ignition switch to LOCK or ACC whilst the vehicle is moving. This would result in loss of directional control and braking function, which could cause an accident.

*** NOTICE**

If you leave the ignition switch to the ACC or ON position for a long time, the battery may discharge.

⚠ WARNING

Key holder

Do not attach small purses, multiple keys, or any other heavy accessories to the driver's key chain used to start the vehicle. This may cause the driver to accidentally make the key inserted in the vehicle to change the ignition position to the ACC position whilst the vehicle is moving thereby increasing the risk of an accident and causing the deactivation of several safety features.

⚠ WARNING**Leaving the Vehicle**

To avoid unexpected or sudden vehicle movement, never leave your vehicle if the gear is not locked in the P (Park) position and the parking brake is fully engaged. Before leaving the driver's seat, always make sure the gear is shifted to P (Park) position, set the parking brake fully and shut the engine off.

Starting the engine**⚠ WARNING**

- Always wear appropriate shoes when operating your vehicle. Unsuitable shoes (high heels, ski boots, etc.) may interfere with your ability to use the brake and accelerator pedal.
 - Do not start the vehicle with the accelerator pedal depressed. The vehicle can move and lead to an accident.
 - Wait until the engine rpm is normal. The vehicle may suddenly move if the brake pedal is released when the rpm is high.
-

*** NOTICE****Kickdown mechanism (if equipped)**

If your vehicle is equipped with a kickdown mechanism in the accelerator pedal, it prevents you from driving at full throttle unintentionally by making the driver require increased effort to depress the accelerator pedal. However, if you depress the pedal more than approximately 82%, the vehicle can be at full throttle and the accelerator pedal will be easier to depress. This is not a malfunction but a normal condition.

⚠ CAUTION

You can also start the engine when the gear is in the N (neutral) position, but for safety, be sure to start the engine only when the gear is in the P (Park) position.

Starting the engine

1. Make sure the parking brake is applied.
2. Make sure the gear is shifted to P (Park) position. Depress the brake pedal fully.
3. Turn the ignition switch to START and hold it there until the engine starts (a maximum of 10 seconds), then release the key. It should be started **without depressing the accelerator pedal**.

- Do not wait for the engine to warm up whilst the vehicle remains stationary. Start driving at moderate engine speeds. (Steep accelerating and decelerating should be avoided.)

Starting and stopping the engine for turbocharger intercooler

- Do not race or accelerate the engine immediately after starting.
If the engine is cold, idle for several seconds before sufficient lubrication is ensured in the turbocharger unit.
- After high speed or extended driving, requiring a heavy engine load, idle the engine about 1 minute before turning it off.
This idle time will allow the turbocharger to cool prior to shutting the engine off.

⚠ CAUTION

Do not turn the engine off immediately after it has been subjected to a heavy load. Doing so may cause severe damage to the engine or turbocharger unit.

⚠ CAUTION

If the engine stalls whilst you are in motion, do not attempt to shift the gear to the P (Park) position. If traffic and road conditions permit, you may put the gear in the N (Neutral) position whilst the vehicle is still moving and turn the ignition switch to the START position in an attempt to restart the engine.

⚠ CAUTION

- Do not engage the starter for more than 10 seconds. If the engine stalls or fails to start, wait 5 to 10 seconds before re-engaging the starter. Improper use of the starter may damage it.
- Do not turn the ignition switch to the START position with the engine running. It may damage the starter.

ENGINE START/STOP button (if equipped)

Illuminated ENGINE START/STOP button



The light will go off after about 30 seconds when the door is closed. It will also go off immediately when the theft-alarm system is armed.

ENGINE START/STOP button position

Your vehicle is equipped with four different ignition positions.

OFF

To turn off the engine (START/RUN position) or vehicle power (ON position), press the ENGINE START/STOP button with the gear in the P (Park) position. When you press the ENGINE START/STOP button without the gear in the P (Park) position, the ENGINE START/STOP button will not change to the OFF position but to the ACC position.

Anti-theft steering column lock (if equipped)

The steering wheel locks when the ENGINE START/STOP button is in the OFF position to protect you against theft. It locks when the door is opened.

If the steering wheel is not locked properly when you open the driver's door, the warning chime will sound. Try locking the steering wheel again. If the problem is not solved, have the system checked by a professional workshop. Kia recommends to visit a professional workshop. Kia recommends to visit an authorised Kia dealer/service partner.

In addition, if the ENGINE START/STOP button is in the OFF position after the driver's door is opened, the steering wheel will not lock and the warning chime will sound. In such a situation, close the door. Then the steering wheel will lock and the warning chime will stop.

*** NOTICE**

If the steering wheel doesn't unlock properly, the ENGINE START/STOP button will not work. Press the ENGINE START/STOP button whilst turning the steering wheel right and left to release the tension.

* NOTICE

You are able to turn off the engine (START/RUN) or vehicle power (ON), only when the vehicle is not in motion.

▲ CAUTION

In an emergency situation whilst the vehicle is in motion, you are able to turn the engine off and to the ACC position by pressing the ENGINE START/STOP button for more than 2 seconds or 3 times repeatedly within 3 seconds.

If the vehicle is still moving, to restart the vehicle:

- Press the ENGINE START/STOP button when vehicle speed is 3 mph (5 km/h) or over.

ACC (Accessory)



OMQ4050294L

Press the ENGINE START/STOP button whilst it is in the OFF position without depressing the brake pedal.

The steering wheel unlocks and electrical accessories are operational.

If the ENGINE START/STOP button is in the ACC position for more than 1 hour, the button is turned off automatically to prevent battery discharge.

ON

Press the ENGINE START/STOP button whilst it is in the ACC position without depressing the brake pedal.

The warning lights can be checked before the engine is started. Do not leave the ENGINE START/STOP button in the ON position for a long time. The battery may discharge, because the engine is not running.

* NOTICE

If you leave the ENGINE START/STOP button in the ACC or ON position for a long time, the battery will discharge.

START/RUN

To start the engine, depress the brake pedal and press the ENGINE START/STOP button with the gear in the P (Park) position. For your safety, start the engine with the gear in the P (Park) position.

* NOTICE

If you press the ENGINE START/STOP button without pressing the brake pedal, the engine will not start and the ENGINE START/STOP button changes as follow:

OFF → ACC → ON → OFF or ACC

⚠ WARNING

- Never press the ENGINE START/STOP button whilst the vehicle is in motion. This would result in loss of directional control and braking function, which could cause an accident.
- Before leaving the driver's seat, always make sure the gear is shifted to P (Park) position, set the parking brake fully and shut the engine off. Unexpected and sudden vehicle movement may occur if these precautions are not taken.
- Never reach for the ENGINE START/STOP button or any other controls through the steering wheel whilst the vehicle is in motion. The presence of your hand or arm in the area could cause loss of vehicle control, an accident and serious bodily injury or death.
- Do not place any movable objects around the driver's seat as they may move whilst driving, interfere

with the driver and lead to an accident.

Starting the engine

⚠ WARNING

- Always wear appropriate shoes when operating your vehicle. Unsuitable shoes (high heels, ski boots, etc.) may interfere with your ability to use the brake, accelerator.
- Do not start the vehicle with the accelerator pedal engaged. The vehicle can move and lead to an accident.
- Wait until the engine rpm is normal. The vehicle may suddenly move if the brake pedal is released when the rpm is high.

* NOTICE

Kickdown mechanism (if equipped)

If your vehicle is equipped with a kickdown mechanism in the accelerator pedal, it prevents you from driving at full throttle unintentionally by making the driver require increased effort to depress the accelerator pedal. However, if you depress the pedal more than approximately 82%, the vehicle can be at full throttle and the accelerator pedal will be easier to depress.

This is not a malfunction but a normal condition.

Starting the engine with smart key

At the time that the vehicle doors are opened or when the ENGINE START/STOP button is pressed the vehicle will check for the smart key.

If the smart key is not in the vehicle, the "🚗" indicator and a message "Key is not in the vehicle" will appear on the instrument cluster and LCD window. And if all doors are closed, the chime will sound for 5 seconds. The indicator or warning will turn off whilst the vehicle is moving. Always have the smart key with you.

⚠️ WARNING

The engine will start, only when the smart key is in the vehicle. Never allow children or any person who is unfamiliar with the vehicle touch the ENGINE START/STOP button or related parts. Pushing the ENGINE START/STOP button whilst the smart key is in the vehicle may result in unintended engine activation and/or unintended vehicle movement.

⚠️ CAUTION

If the engine stalls whilst the vehicle is in motion, do not attempt to move the gear to the P (Park) position. If the traffic and road conditions permit, you may put the gear in the N (Neutral) position whilst the vehicle is still moving and press the ENGINE START/STOP button in an attempt to restart the engine.

*** NOTICE**

- If the battery is weak or the smart key does not work correctly, you can start the engine by pressing the ENGINE START/STOP button with the smart key. When you press the ENGINE START/STOP button directly with the smart key, the smart key should contact the button at a right angle.



- When the stop lamp fuse is blown, you cannot start the engine normally.

Replace the fuse with a new one. If it is not possible, you can start the engine by pressing the ENGINE START/STOP button for 10 seconds whilst it is in the ACC position. The engine can start without pressing the brake pedal. But for your safety always press the brake pedal before starting the engine.

CAUTION

- Do not press the ENGINE START/STOP button for more than 10 seconds except when the stop lamp fuse is blown.
- Do not turn the ignition switch to the START position with the engine running. It may damage the starter.

CAUTION

You can also start the engine when the gear is in the N (neutral) position, but for safety, be sure to start the engine only when the gear is in the P (Park) position.

Starting the engine

1. Carry the smart key or leave it inside the vehicle.
2. Make sure the parking brake is firmly applied.
3. Make sure the gear is shifted to P (Park) position. Depress the brake pedal fully.
4. Press the ENGINE START/STOP button.

It should be started without depressing the accelerator pedal.

5. Do not wait for the engine to warm up whilst the vehicle remains stationary. Start driving at moderate engine speeds. (Steep accelerating and decelerating should be avoided.)

Starting and stopping the engine for turbocharger intercooler

1. Do not race or accelerate the engine immediately after starting.

If the engine is cold, idle for several seconds before sufficient lubrication is ensured in the turbocharger unit.

2. After high speed or extended driving, requiring a heavy engine load, idle the engine about 1 minute before turning it off. This idle time will allow the turbocharger to cool prior to shutting the engine off.

⚠ CAUTION

Do not turn the engine off immediately after it has been subjected to a heavy load. Doing so may cause severe damage to the engine or turbocharger unit.

Automatic transmission (Dial SBW)

The automatic transmission has 6 forward speeds and one reverse speed. The individual speeds are selected automatically, depending on the balance between the fuel economy and the power.

Automatic transmission operation

Select transmission positions by turning the dial SBW.

**⚠ WARNING**

To reduce the risk of serious injury or death:

- ALWAYS check the surrounding areas near your vehicle for people, especially children, before shifting a vehicle into D (Drive) or R (Reverse).
- Before leaving the driver's seat, always make sure the gear is in the P (Park) position, then set the parking brake, and place the

ENGINE START/STOP button in the OFF position. Unexpected and sudden vehicle movement can occur if these precautions are not followed.

For your safety, always depress the brake pedal whilst shifting to another gear.

Transmission position

The indicator in the instrument cluster displays the transmission position when the ENGINE START/STOP button is in the ON position.

Type A



Type B



P (Park)

Always come to a complete stop before shifting into P (Park).

To shift the gear from R (Reverse), N (Neutral) or D (Drive) to P (Park), press the [P] button.

If you turn off the vehicle in D (Drive), N (Neutral) or R (Reverse), the gear automatically shifts to P (Park).

With the vehicle on, the gear automatically shifts to P (Park) if you open the driver's door when the gear is in N (Neutral), R (Reverse) or D (Drive) and the following conditions are met:

- The brake/accelerator pedal is not depressed.
- The seat belt is unfastened.
- The vehicle speed is below 2 km/h (1 mph).

When the vehicle is over a certain speed, the gear does not shift to P (Park) when the P button is pressed.

⚠ WARNING

- Shifting into P (Park) whilst the vehicle is in motion may cause you to lose control of the vehicle.
- After the vehicle has stopped, always make sure the gear is in P (Park), apply the parking brake, and turn the vehicle off.
- Do not use the P (Park) position in place of the parking brake.

R (Reverse)

Use this position to drive the vehicle backward.

To shift to R (Reverse), turn the dial SBW to the [R] position whilst depressing the brake pedal.

⚠ CAUTION

Shifting

Always come to a complete stop before shifting into or out of R (Reverse); you may damage the transmission if you shift into R (Reverse) whilst the vehicle is in motion, except on "Rocking the vehicle" ("Rocking the vehicle" on page 6-222).

N (Neutral)

The wheels and gear are not engaged.

To shift to N (Neutral), turn the dial SBW to the [N] position whilst depressing the brake pedal.

Always depress the brake pedal when you are shifting from N (Neutral) to another gear.

In N (Neutral), if the driver attempts to turn off the vehicle, the vehicle is turned OFF and shifted to the P (Park) position automatically.

Stay in N (Neutral) position when engine is Off

If you want to keep the N (Neutral) position after the engine is OFF, do the following.





OMQ4041020L

1. Deactivate the AUTO HOLD and release the parking brake when the ENGINE START/STOP button is ON.
2. Turn the dial SBW to the N (Neutral) position by depressing the brake pedal. If the message ("Press and hold OK button to stay in Neutral when vehicle is Off") appears on the cluster LCD display, press and hold the OK button on the steering wheel for more than 1 second. After the message is disappeared, the vehicle cannot keep the N position when the engine is off.
3. Turn off the engine after the message ("Vehicle will stay in (N). Change gear to cancel") appears on the cluster LCD display.

In this situation, if you unfasten the driver's seat belt and open the driver's door within 3 minutes, the gear shifts to P (Park) position and the ENGINE START/STOP button is turned off.

When the battery is discharged:

You cannot shift the shift dial, when the battery is discharged.

In emergencies, do the following to move the shift dial to N (Neutral) on a level ground.

1. Connect the battery cables from another vehicle or from a another battery to the jump-starting terminals inside the engine compartment. For more details, refer to "Jump-starting" on page 7-6.
2. Release the parking brake with the ENGINE START/STOP button in the ON position.
3. Shift the gear to the N (Neutral) position. If you want to keep the N position after the engine is off, disconnect the battery from vehicle or refer to "Stay in N (Neutral) position when engine is Off" on page 6-19.

CAUTION

- Always park the vehicle in "P"(Park) for safety and engage the parking brake. If left in "N", the vehicle may move and cause serious damage and injury.
- After the ENGINE START/STOP button has been turned off, the electronic parking brake cannot be disengaged.
- For EPB (Electronic Parking Brake) equipped vehicles with AUTO HOLD function used whilst driving, if the ignition button has been turned "OFF", the electronic park-

ing brake will be engaged automatically. Therefore, AUTO HOLD function should be turned off before the ignition button is turned off.

D (Drive)

This is the normal driving position.

To shift to D (Drive), move the dial SBW to the D (Drive) position whilst depressing the brake pedal.

In D (Drive), if the driver attempts to turn off the vehicle, the vehicle is turned OFF and shifted to the P (Park) position automatically.

Shift-lock system

For your safety, your vehicle has a shift-lock system which prevents shifting the gear from P (Park) or N (Neutral) into R (Reverse) or D (Drive) unless the brake pedal is depressed.

To shift from P (Park) or N (Neutral) into R (Reverse) or D (Drive), from R (Reverse) into D (Drive) or from D (Drive) into R (Reverse):

1. Depress and hold the brake pedal.
2. Start the vehicle or place the ENGINE START/STOP button in the ON position.
3. Turn the dial SBW to the R (Reverse) or D (Drive) position.

When the battery (12 V) is discharged

You cannot shift the gear when the battery is discharged.

Jump start your vehicle (refer to "Jump-starting" on page 7-6) or contact an authorised Kia dealer/service partner.

LCD display messages

If a message appears on the LCD display, refer to the next section for the appropriate steps to take.

Shifting conditions not met

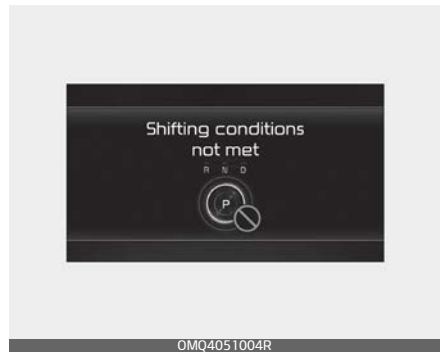

The message appears on the LCD display in the following conditions:

- When driving speed is too fast to shift the gear. Decrease the vehicle speed or slow down before shifting the gear.

Press brake pedal to change gear

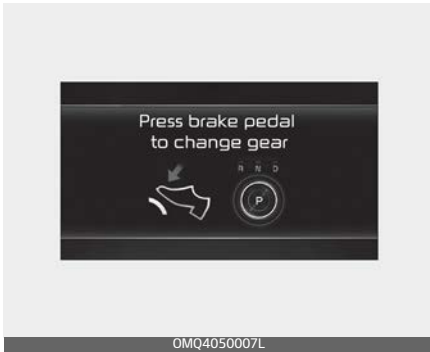

The message appears on the LCD display, when the brake pedal is not depressed whilst shifting the gear.

Depress the brake pedal and then shift the gear.

Shift to P after stopping



The message appears on the LCD display when the gear is shifted to P (Park) whilst the vehicle is moving.

Stop the vehicle before shifting to P (Park).

Gear already selected



The message appears on the LCD display when the P gear is selected again or the gear is overheated.

PARK malfunction. Engage parking brake when parking vehicle



The message is displayed when there is a problem with function engaging P (Park) position.

Immediately have the vehicle inspected by an authorised Kia dealer/service partner.

Check P button

The message appears on the LCD display when there is problem with the P button.

Immediately have the vehicle inspected by an authorised Kia dealer/service partner.

Check dial SBW

The message appears on the LCD display when there is problem with the dial SBW.

Immediately have the vehicle inspected by an authorised Kia dealer/service partner.

Rotary shifter stuck

The message appears on the LCD display when the dial SBW is continuously stuck or there is problem with the dial SBW.

Make sure that there is no object around the dial SBW. If the problem persists, immediately have the vehicle inspected by an authorised Kia dealer/service partner.

Paddle shifter

The paddle shifter function is available when the dial SBW is in the D (Drive) position.



With the dial SBW in the D position

The paddle shifter will operate when the vehicle speed is more than 10km/h.

Pull the [+] or [-] paddle shifter once to shift up or down one gear and the system changes from automatic mode to manual mode.

When the vehicle speed is lower than 10km/h, or if you depress the accelerator pedal for more than 5 seconds, the system changes from manual mode to automatic mode.

* NOTICE

If you pull the [+] and [-] paddle shifters at the same time, you cannot shift the gear.

Good driving practices

- Never move the shift dial SBW from P (Park) or N (Neutral) to any other position with the accelerator pedal depressed.
- Never move the shift dial SBW into P (Park) when the vehicle is in motion.
- Be sure the vehicle is completely stopped before you attempt to shift into R (Reverse) or D (Drive).
- Never take the vehicle out of gear and coast down a hill. This may be extremely hazardous. Always leave the vehicle in gear when moving.
- Do not "ride" the brakes. This can cause them to overheat and malfunction. Instead, when you are driving down a long hill, slow down and shift to a lower gear. When you do this, engine braking will help slow down the vehicle.
- Slow down before shifting to a lower gear. Otherwise, the lower gear may not be engaged.
- Always use the parking brake. Do not depend on placing the transmission in P (Park) to keep the vehicle from moving.
- Exercise extreme caution when driving on a slippery surface. Be especially careful when braking, accelerating or shifting gears. On a slippery surface, an abrupt change in vehicle speed can cause the drive wheels to lose traction

and the vehicle to go out of control.

- Optimum vehicle performance and economy is obtained by smoothly depressing and releasing the accelerator pedal.

WARNING

- When driving uphill or downhill, always shift to D (Drive) for driving forward or shift to R (Reverse) for driving backwards, and check the gear position indicated on the cluster before driving. Driving in the opposite direction of the selected gear can lead to a dangerous situation by shutting off the engine and affecting the braking performance.
- Always buckle-up! In a collision, an unbelted occupant is significantly more likely to be seriously injured or killed than a properly belted occupant.
- Avoid high speeds when cornering or turning.
- Do not make quick steering wheel movements, such as sharp lane changes or fast, sharp turns.
- The risk of a rollover is greatly increased if you lose control of your vehicle at highway speeds.
- Losing control often occurs if two or more wheels drop off the roadway and the driver oversteers to reenter the roadway.

- In the event your vehicle leaves the roadway, do not steer sharply. Instead, slow down before pulling back into the travel lanes.
- Never exceed posted speed limits.

WARNING

If your vehicle becomes stuck in snow, mud, sand, etc., then you may attempt to rock the vehicle free by moving it forward and backward. Do not attempt this procedure if people or objects are anywhere near the vehicle. During the rocking operation the vehicle may suddenly move forward or backward as it becomes unstuck, causing injury or damage to nearby people or objects.

Moving up a steep grade from a standing start

To move up a steep grade from a standing start:

- Depress the brake pedal, shift the shift dial SBW to D (Drive). Select the appropriate gear depending on load weight and steepness of the grade, and release the parking brake. Depress the accelerator gradually after releasing the service brakes.

All Wheel Drive (AWD) system (if equipped)

The All Wheel Drive (AWD) system delivers engine power to front and rear wheels for maximum traction.

AWD is useful when extra traction is required, such as when driving slippery, muddy, wet, or snow-covered roads.



If the system determines there is a need for four wheel drive, the engine's driving power will be distributed to all four wheels automatically.

WARNING

Off road driving

This vehicle is designed primarily for on road use although it can operate effectively off road. However, it was not designed to drive in challenging off-road conditions. Driving in conditions that exceed the vehicle's intended design or the driver's experience level may result in severe injury or death. (if equipped)

WARNING

If the AWD warning light () stays on the instrument cluster, your vehicle may have a malfunction with the AWD system. When the AWD warning light () illuminates, have your vehicle checked by a professional workshop. Kia recommends to visit an authorised Kia dealer/service partner.

WARNING

To reduce the risk of SERIOUS INJURY or DEATH:

- Do not drive in conditions that exceed the vehicle's intended design such as challenging off-road conditions.
- Avoid high speeds when cornering or turning.
- Do not make quick steering wheel movements, such as sharp lane changes or fast, sharp turns.
- The risk of a rollover is greatly increased if you lose control of your vehicle at highway speeds.
- Loss of control often occurs if two or more wheels drop off the roadway and the driver over steers to reenter the roadway.

- In the event your vehicle leaves the roadway, do not steer sharply. Instead, slow down before pulling back into the travel lanes.

AWD (AWD/TERRAIN MODE)

AWD helps the vehicle to maintain its best driving performance by controlling 4 wheels, engine, transmission and braking according to road conditions such as snow, mud, sand, etc.

Advantages of AWD

- Enhance safety when driving straight.
- Improve performance when cornering.
- Ensure operability in tough driving conditions such as snow, rain, sand, etc.

Switching from/to TERRAIN MODE





You can switch from DRIVE MODE to TERRAIN mode by pressing DRIVE/TERRAIN mode button and then select SNOW, MUD, or SAND mode by turning TERRAIN MODE knob. If you press the DRIVE/TERRAIN mode button again, the vehicle will go back to DRIVE MODE.

*** NOTICE**

Even though you turned off the vehicle in TERRAIN mode, DRIVE mode will be set when you restart the vehicle.

AWD transfer mode selection

Transfer mode	Selection mode	Description
DRIVE MODE	-	<ul style="list-style-type: none"> • DRIVE MODE is used when driving on roads in normal conditions, roads in urban areas, and on highways. • All wheels are in operation when a vehicle travels at a constant speed. Required tractions applying on front and rear wheels vary depending on road driving conditions and driving conditions, which will be automatically controlled by the computing system. • When the cluster's DRIVE MODE display mode is selected, the cluster displays the status of how four wheels' traction forces are distributed.
SNOW	 <p>OMQ4040463</p>	<p>SNOW mode is used to appropriately distribute the vehicle's traction forces and prevent wheel slippage when driving on snowy or slippery road.</p>
MUD	 <p>OMQ4040433</p>	<p>MUD mode is used to ensure safe driving by appropriately distributing the vehicle's traction forces when driving on muddy, unpaved or rough roads.</p>
SAND	 <p>OMQ4040434</p>	<p>SAND mode is used to ensure safe driving by appropriately distributing the vehicle's traction forces when driving on sandy, gravelled or unpaved off-roads.</p>

* SNOW ↔ MUD ↔ SAND

⚠ CAUTION

Maintain DRIVE mode when driving on roads in normal conditions. Driving in TERRAIN mode on normal roads may damage the AWD system and cause mechanical vibration or noise.

When driving (especially when cornering) under normal road conditions in TERRAIN mode, a driver may find minor mechanical vibration or noise, which is extremely normal phenomenon, not a malfunction. When TERRAIN mode is released, such noise or vibration will be immediately gone. When you turn off TERRAIN mode, it can lead to little shocks but this is a normal phenomenon that lasts until the traction forces on the front and rear wheels of the vehicle are released.

For safe All Wheel Drive (AWD) operation**⚠ WARNING****All Wheel Drive**

The conditions of on-road or off-road that demand All Wheel Drive mean all functions of your vehicle are exposed to extreme stress than under normal road conditions. Slow down and be ready for changes in the composition and traction of the surface under your tyres. If you have any doubt about the safety of

the conditions you are facing, stop and consider the best way to proceed.

- Do not try to drive in deep standing water or mud since such conditions can stall your engine and clog your exhaust pipes. Do not drive down steep hills since it requires extreme skill to maintain control of the vehicle.



- When you are driving up or down hills drive as straight as possible. Use extreme caution in going up or down steep hills, since you may flip your vehicle over depending on the grade, terrain and water/mud conditions.



⚠ WARNING

Hills

Driving across the contour of steep hills can be extremely dangerous. This danger can come from slight changes in the wheel angle which can destabilise the vehicle or, even if the vehicle is maintaining stability under power, it can lose that stability if the vehicle stops its forward motion. Your vehicle may roll over without warning and without time for you to correct a mistake that could cause serious injury or death.

- You must learn how to corner in a AWD vehicle. Do not rely on your experience in conventional FWD vehicles when cornering the vehicle in AWD mode. For starters, you must drive slower in AWD.

⚠ WARNING

All Wheel Drive (AWD)

Reduce speed when you turn corners. The centre of gravity of AWD vehicles is higher than that of conventional FWD vehicles, making them more likely to roll over when you turn corners too fast.



⚠ WARNING

Steering wheel

Do not grab the inside of the steering wheel when you are driving on unpaved roads. You may hurt your arm by a sudden steering manoeuvre or from steering wheel rebound due to impact with objects on the ground. You could lose control of the steering wheel.

- Always hold the steering wheel firmly when you are driving on unpaved roads.
- Make sure all passengers are wearing seat belts.

⚠ WARNING**Wind danger**

If you are driving in heavy wind, the vehicle's higher centre of gravity decreases your steering control capacity and requires you to drive more slowly.

⚠ WARNING**Driving through water**

Drive slowly. If you are driving too fast in water, the water can get into the engine compartment and wet the ignition system, causing your vehicle to suddenly stop. If this happens and your vehicle is in a tilted position, your vehicle may roll over.

*** NOTICE**

- Do not drive in water if the level is higher than the bottom of the vehicle.
- Check your brake condition once you are out of mud or water. Press the brake pedal several times as you move slowly until you feel normal braking forces return.
- Shorten your scheduled maintenance interval if you drive in offroad conditions such as sand, mud or water (refer to "Maintenance under severe usage conditions- for Europe" on page 8-18).

Always wash your vehicle thoroughly after off-road use, especially cleaning the bottom of the vehicle.

- Since the driving torque is always applied to the 4 wheels the performance of the AWD vehicle is greatly affected by the condition of the tyres. Be sure to equip the vehicle with four tyres of the same size and type.
- A full time All Wheel Drive vehicle cannot be towed by an ordinary tow truck. Make sure that the vehicle is placed on a flat bed truck for moving.

⚠ WARNING**All Wheel Drive (AWD) driving**

- Avoid high cornering speed.
- Do not make quick steering wheel movements, such as sharp lane changes or fast, sharp turns.
- The risk of rollover is greatly increased if you lose control of your vehicle at high speed.
- In a collision, an unbelted person is significantly more likely to die compared to a person wearing a seat belt.
- Loss of control often occurs if two or more wheels drop off the roadway and the driver over-steers to re-enter the roadway. In the event your vehicle leaves the roadway, do not steer sharply.

Instead, slow down before pulling back into the travel lanes.

⚠ CAUTION

Mud or snow

If one of the front or rear wheels begins to spin in mud, snow, etc. the vehicle can sometimes be driven out by engaging the accelerator pedal further; however avoid running the engine continuously at high rpm because doing so could damage the AWD system.

Driving in sand or mud

- Maintain slow and constant speed. Operate the accelerator pedal slowly to ensure safe driving (wheel-slip prevention).
- Keep sufficient distance between your vehicle and the vehicle in front of you.
- Reduce vehicle speed and always check the road condition.
- Avoid speeding, rapid acceleration, sudden brake applications, and sharp turns to prevent getting stuck.
- When the vehicle is stuck in snow, sand or mud, the tyres may not operate.
- This is to protect the transmission and not a malfunction.

* NOTICE

Moving the vehicle forcibly to get out of mud or sand can cause damage/overheat of the engine or damage/breakdown of the transmission, differential or 4WD system as well as damage to tyres. If excessive wheel slip occurs after entering a sandy/muddy road, the vehicle may fall into the sand/mud. When it happens, put a stone or a tree branch under the tyre, and then try to pull out the vehicle, or try to get it unstuck by repeatedly moving forwards and backwards.

Transmission overheated





0MQ4050032R

- When driving on muddy and sandy roads under the severe condition, the transmission could be overheated.
 - When the transmission is overheated, the safe protection mode engages and the "Transmission Hot! Park with engine on" warning message will appear on the LCD display with a chime.
 - If this occurs, pull over to a safe location, stop the vehicle with the engine running, apply the brakes and shift the vehicle to P (Park), and allow the transmission to cool.
 - If you ignore this warning, the driving condition may become worse. You may experience abrupt shifts, frequent shifts, or jerkiness. To return to the normal driving condition, stop the vehicle and apply the foot brake or shift into P (Park). Then allow the transmission to cool for a few minutes with engine on, before driving off.
- When the message "Trans cooled. Resume driving" appears you can continue to drive your vehicle.
- If the warning messages in the LCD display continue to blink, for your safety, have the system checked by a professional workshop. Kia recommends to visit an authorised Kia dealer/service partner.

Tyre precautions

Always pay attention to tyres for AWD (all-wheel drive) vehicles.

When driving in all-wheel drive, driving force is applied to all tyres, and the driving performance of the vehicle is greatly affected by the degree of tyre wear:

- When replacing tyres, be sure to equip all four tyres with the same size, type, tread, brand and load-carrying capacity. Do not use tyre and wheel with different size and type from the one originally installed on your vehicle. It can affect the safety and performance of your vehicle, which could lead to steering failure or rollover causing serious injury.
- Replace the front and rear tyre positions every 10,000 km.
- Each tyre should be checked monthly when cold and inflated to inflation pressure recommended by the vehicle manufacturer on

the vehicle placard or tyre inflation pressure label.

- For FWD (front wheel drive) and AWD (all-wheel drive) vehicles, install the chains on the front wheels. However, this may damage the AWD system, so keep the travel distance as short as possible.

* Refer to "Tyre chains" on page 6-226.

Towing precautions



The AWD vehicle should never be towed with the wheels on the ground. Your vehicle must be towed with a wheel lift and dollies or flatbed equipment with all the wheels off the ground.

* Refer to "Trailer towing (if equipped)" on page 6-230.

CAUTION

The AWD vehicle cannot be towed with sling-type equipment. Use wheel lift or flatbed equipment.

WARNING

Your vehicle is equipped with tyres designed to provide safe ride and handling capability. Do not use tyres and wheels that are different in size and type from the originally installed ones. It can affect the safety and performance of your vehicle, which could lead to steering failure or rollover and serious injury. When replacing the tyres, be sure to equip all four tyres with the tyre and wheel of the same size, type, tread, brand and load-carrying capacity.

WARNING

Jacked vehicle

Whilst the full-time AWD vehicle is being raised on a jack, never start the engine or cause the tyres to rotate.

There is the danger that rotating tyres touching the ground could cause the vehicle to go off the jack and to jump forward.

- Full-time AWD vehicles must be tested on a special four wheel chassis dynamometer.

* NOTICE

Never engage the parking brake whilst performing these tests.

⚠ WARNING

Dynamometer testing

Keep away from the front of the vehicle whilst the vehicle is in gear on the dynamometer. This is very dangerous as the vehicle can jump forward and cause serious injury or death.

⚠ CAUTION

- When lifting up the vehicle, do not operate front and rear wheel separately. All four wheels should be operated.
- If you need to operate the front wheel and rear wheel when lifting up the vehicle, you should release the parking brake.

Brake system

Your vehicle has power-assisted brakes, parking brake, and various braking systems for safe driving.

Power brakes

Your vehicle has power-assisted brakes that adjust automatically through normal usage.

In the event that the power-assisted brakes lose power because of a stalled engine or some other reason, you can still stop your vehicle by applying greater force to the brake pedal than you normally would. The stopping distance, however, will be longer.

When the engine is not running, the reserve brake power is partially depleted each time the brake pedal is applied. Do not pump the brake pedal when the power assist has been interrupted.

* NOTICE

- When stepping on the brake pedal under a certain driving or weather condition, you may witness your car make a sound of squealing or some other noises. This is not a brake malfunction but a normal phenomenon.
- When driving on the road to which deicing chemicals are applied, the vehicle may witness

noises from the brake or abnormal abrasion of tires because of such deicing chemicals. You should operate brake additionally so that you would be able to remove the deicing chemicals on the brake disk and pad under a safe traffic condition.

CAUTION

Brake Pedal

Do not drive with your foot resting on the brake pedal. This will create abnormally high brake temperatures which can cause excessive brake lining and pad wear.

WARNING

Steep hill braking

Avoid continuous application of the brakes when descending a long or steep hill by shifting to a lower gear. Continuous brake application will cause the brakes to overheat and could result in a temporary loss of braking performance.

Wet brakes may impair the vehicle's ability to safely slow down; the vehicle may also pull to one side when the brakes are applied. Applying the brakes lightly will indicate whether they have been affected in this way. Always test your brakes in this fashion after driving through

deep water. To dry the brakes, apply them lightly whilst maintaining a safe forward speed until brake performance returns to normal.

In the event of brake failure

If service brakes fail to operate whilst the vehicle is in motion, you can make an emergency stop with the parking brake. The stopping distance, however, will be much greater than normal.

WARNING

Parking brake

Avoid applying the parking brake to stop the vehicle whilst it is moving except in an emergency situation. Applying the parking brake whilst the vehicle is moving at normal speeds can cause a sudden loss of control of the vehicle. If you must use the parking brake to stop the vehicle, use great caution in applying the brake.

Brake Over Accelerator

In the event the accelerator pedal becomes stuck or entrapped, apply steady and firm pressure to the brake pedal to slow the vehicle and reduce engine power.

If you experience this condition, take the following steps:

1. Apply the brakes and bring your vehicle to a safe stop.
2. Move the transmission to P (Park), switch the engine off and apply the parking brake.
3. Inspect the accelerator pedal for any interference.

If none are found and the condition persists, have your vehicle towed to a professional workshop and inspected. Kia recommends to visit an authorised Kia dealer/service partner.

Disc brakes wear indicator

When your brake pads are worn and new pads are required, you will hear a high-pitched warning sound from your front brakes or rear brakes. You may hear this sound come and go or it may occur whenever you press the brake pedal.

Always replace the front or rear brake pads as pairs.

⚠ CAUTION

Replace brake pads

Do not continue to drive with worn brake pads. Continuing to drive with worn brake pads can damage the braking system and result in costly brake repairs.

⚠ WARNING

Brake wear

Do not ignore high pitched wear sounds from your brakes. If you ignore this audible warning, you will eventually lose braking performance, which could lead to a serious accident.

*** NOTICE**

Brake dust may accumulate on the wheels, even under normal driving conditions. Some dust is inevitable as the brakes wear and contribute to brake noise.

Electronic Parking Brake (EPB)

After parking the vehicle, apply the Electronic Parking Brake (EPB) to prevent the vehicle from being moved by the external force.

Applying the parking brake with EPB switch



OMQ4050318R

1. Depress the brake pedal.
2. Pull up the EPB switch.

Make sure the warning light comes on.

Also, the EPB is applied automatically if the Auto Hold button is on when the vehicle is turned off. In addition, if you pull up the EPB switch after the vehicle is turned off, the EPB will be applied.

▲ WARNING

Risk of accident and injury due to children left unattended in the vehicle.

If you leave children unaccompanied in the vehicle, they may be able to set the vehicle in motion, for example by:

- Releasing the parking brake.
- Shifting the transmission out of P (Park) position.
- Starting the engine. In addition, they may operate vehicle equipment.

Never leave children and animals unattended in the vehicle.

When leaving the vehicle, always take the smart key with you and lock the vehicle.

*** NOTICE**

On a steep incline or when pulling a trailer, if the vehicle does not remain at a standstill, do as follows:

1. Apply the EPB.
2. Pull up the EPB switch for more than 3 seconds.

Do not operate the EPB whilst the vehicle is moving except in an emergency situation.

*** NOTICE**

A click or electric brake motor whine sound may be heard whilst operating or releasing the EPB.

These conditions are normal and indicate that the EPB is functioning properly.

Releasing the parking brake with EPB switch



Releasing the parking brake with EPB switch,

1. Have the ENGINE START/STOP button in the ON position.
2. Press the brake pedal.
3. Press the EPB switch.
4. Make sure the brake warning light goes off.

Automatic release of EPB

The EPB is released automatically under following conditions.

- Automatic transmission
 1. Start the engine.
 2. Fasten the driver's seat belt.
 3. Close the driver's door, bonnet and tailgate.
 4. Press the accelerator pedal whilst the gear is in R (Rear), D (Drive) or Sports mode.

Make sure the brake warning light goes off.

*** NOTICE**

- For your safety, you can engage the EPB even though the ENGINE START/STOP button is in the OFF position, but you cannot release it.
- For your safety, press the brake pedal and release the parking brake manually with the EPB switch when you drive downhill or when backing up the vehicle.

Do not follow the above procedure when driving on a flat level ground. The vehicle may suddenly move forward.

*** NOTICE**

If the parking brake warning light is still on even though the EPB has been released, have the system checked by a professional workshop.

Kia recommends to visit an authorised Kia dealer/service partner.

⚠ CAUTION

Do not drive your vehicle with the EPB applied. It may cause excessive brake pad and brake rotor wear.

Automatic application of EPB

The EPB is applied automatically under following conditions.

- Shift to P (Park) on a slope
- Engine OFF whilst AUTO HOLD button is on
- When the vehicle moves a bit in P (Park) position
- Conditions below whilst AUTO HOLD is activated:
 - Driver's door is opened
 - Bonnet is opened
 - Tailgate is opened
 - Vehicle stops for more than approximately 10 minutes
- Requested by other systems

*** NOTICE**

For Electronic Parking Brake (EPB) equipped vehicles with AUTO HOLD function used whilst driving, if the ENGINE START/STOP button has been turned OFF, the EPB will be engaged automatically. Therefore,

AUTO HOLD function should be turned off before the ENGINE START/STOP button is turned off.

EPB warning

The EPB will display a warning message with sound under certain conditions.

- If you try to drive off whilst engaging the accelerator pedal with the EPB applied, but the EPB doesn't release automatically, a warning will sound and a message will appear.
- If the driver's seat belt is not fastened and the vehicle bonnet, driver's door or tailgate is opened, a warning will sound and a message will appear.



- If there is a problem with the vehicle, a warning may sound and a message may appear.

If the above situation occurs, press the brake pedal and release EPB by pressing the EPB switch.

⚠ WARNING

Parking brake use

- Never allow a passenger to touch the parking brake. If the parking brake is released unintentionally, serious injury may occur.
- All vehicles should always have the parking brake fully engaged when parked to avoid inadvertent movement of the vehicles which can injure occupants or pedestrians.
- A click or electric brake motor whine sound may be heard whilst operating or releasing the EPB. These conditions are normal and indicate that the EPB is functioning properly.
- When leaving your keys with a parking lot attendant or valet, make sure to inform him/her how to operate the EPB.
- The EPB may malfunction if you drive with the EPB applied.
- When you automatically release EPB by pressing the accelerator pedal, press it slowly.

When the conversion from Auto Hold to EPB is not working properly a warning will sound and a message will appear.



OMQ4050056L

* NOTICE

Engage the brake pedal when the above message appears for the Auto Hold and EPB may not activate.

If the EPB is applied whilst Auto Hold is activated because of an Electronic Stability Control (ESC) signal, a warning will sound and a message will appear.



OMQ4050054R

EPB malfunction indicator

This warning light illuminates if the ENGINE START/STOP button is changed to the ON position and goes off in approximately 3 seconds if the system is operating normally.



OMQ4AH050050

If the EPB malfunction indicator remains on, comes on whilst driving, or does not come on when the ENGINE START/STOP button is changed to the ON position, this indicates that the EPB may have malfunctioned.

If this occurs, have your vehicle checked by a professional workshop as soon as possible. Kia recommends to visit an authorised Kia dealer/service partner.

The EPB malfunction indicator may illuminate when the ESC indicator comes on to indicate that the ESC is not working properly, but it does not indicate a malfunction of the EPB.

* NOTICE

The EPB warning light may illuminate if the EPB switch operates abnormally. Shut the engine off and turn it on again after a few minutes. The warning light will go off and the EPB switch will operate normally. However, if the EPB warning light is still on, have the system checked by a professional workshop. Kia recommends to visit an authorised Kia dealer/service partner.

If the parking brake warning light does not illuminate or blinks even though the EPB switch was pulled up, the EPB is not applied.

If the parking brake warning light blinks when the EPB warning light is on, press the EPB switch, then pull it up. Once more press it back to its original position and pull it back up. If the EPB warning does not go off, have the system checked by a professional workshop. Kia recommends to visit an authorised Kia dealer/service partner.

Emergency braking with the EPB switch

If there is a problem with the brake pedal whilst driving, emergency braking is possible by pulling up and holding the EPB switch.

Braking is possible only whilst you are holding the EPB switch.

⚠ WARNING

Do not operate the Electronic Parking Brake (EPB) whilst the vehicle is moving except in an emergency situation. Applying the EPB whilst the vehicle is moving at normal speeds can cause a sudden loss of control of the vehicle. If you must use the EPB to stop the vehicle, use great caution in applying the brake.

* NOTICE

During emergency braking by the EPB, the parking brake warning light will illuminate to indicate that the system is operating.

If you notice a continuous noise or burning smell when the EPB is used for emergency braking, have your vehicle checked by a professional workshop. Kia recommends to visit an authorised Kia dealer/service partner.

When the EPB is not released

If the EPB does not release normally, take your vehicle to a professional workshop by loading the vehicle on a flatbed tow truck and have the system checked. Kia recommends to visit an authorised Kia dealer/service partner.

AUTO HOLD

The Auto Hold is designed to maintain the vehicle in a standstill even though the brake pedal is not pressed after the driver brings the vehicle to a complete stop by pressing the brake pedal.

Applying Auto Hold function

1. Press the brake pedal and start the vehicle.
2. Press the Auto Hold button. The white AUTO HOLD indicator will come on indicating the system is in standby.



Before the Auto Hold will engage, the driver's door, tailgate and engine bonnet must be closed.

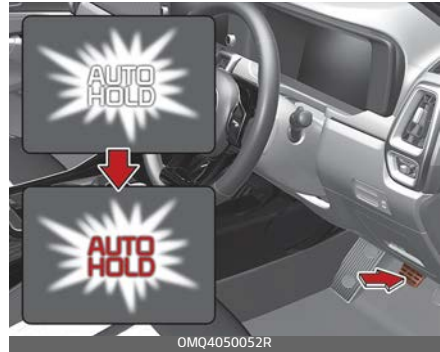

When coming to a complete stop by pressing the brake pedal, the AUTO HOLD indicator changes from white to green indicating the AUTO HOLD is engaged. The vehicle will remain at a standstill even if you release the brake pedal.

If EPB is applied, Auto Hold will be released.

If you press the accelerator pedal with the gear in D (Drive), R (Reverse) or Manual mode, the Auto Hold will be released automatically and the vehicle will start to move.

The indicator changes from green to white indicating the Auto Hold is in standby and the EPB is released.

When driving off from Auto Hold by pressing the accelerator pedal, always check the surrounding area near your vehicle.

Slowly press the accelerator pedal for a smooth launch.

Canceling Auto Hold function



- To cancel the Auto Hold operation, press the Auto Hold switch. The AUTO HOLD indicator will go out.
- To cancel the Auto Hold operation when the vehicle is at a standstill, press the Auto Hold switch whilst pressing the brake pedal.

* NOTICE

- The following are conditions when the Auto Hold will not engage (Auto Hold light will not turn green and the Auto Hold system remains in stand by):
 - The driver's door is opened
 - The engine bonnet is opened
 - The tailgate is opened
 - The gear is in P (Park)
 - The EPB is applied
- For your safety, the Auto Hold automatically switches to EPB under any of the following conditions (Auto Hold light remains white and the EPB automatically applies):
 - The driver's door is opened.

- The engine bonnet is opened.
- The tailgate is opened
- The vehicle is in a standstill for more than 10 minutes.
- The vehicle is standing on a steep slope.
- The vehicle moved for a few seconds.

In these cases, the brake warning light comes on, the AUTO HOLD indicator changes from green to white, and a warning sounds and a message will appear to inform you that EPB has been automatically engaged. Before driving off again, press foot brake pedal, check the surrounding area near your vehicle and release parking brake manually with the EPB switch.

- If the AUTO HOLD indicator lights up yellow, the Auto Hold is not working properly. Take your vehicle to a professional workshop and have the system checked. Kia recommends to visit an authorised Kia dealer/service partner.

⚠ WARNING

To reduce the risk of an accident, do not activate Auto Hold whilst driving downhill, backing up or parking your vehicle.

If there is a malfunction with the driver's door, tailgate or engine bonnet open detection system, the Auto Hold may not work properly.

Take your vehicle to a professional workshop and have the system checked. Kia recommends to visit an authorised Kia dealer/service partner.

*** NOTICE**

A click or electric brake motor whine sound may be heard whilst operating or releasing the EPB, but these conditions are normal and indicate that the EPB is functioning properly.

Warning messages

The Auto Hold function will display a warning message with sound under certain conditions.

When the EPB is applied from Auto Hold, a warning will sound and a message will appear.



When the conversion from Auto Hold to EPB is not working properly a warning will sound and a message will appear.



*** NOTICE**

When this message is displayed, the Auto Hold and EPB may not operate. For your safety, press the brake pedal.

If you do not apply the brake pedal when you release the Auto Hold by pressing the [AUTO HOLD] switch, a warning will sound and a message will appear.

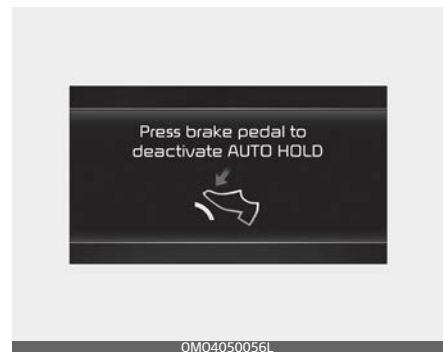

When you press the [AUTO HOLD] switch, if the driver's door, tailgate and engine bonnet are not closed, a warning will sound and a message will appear on the LCD display.



At this moment, press the [AUTO HOLD] button after closing the driver's door, engine bonnet and tailgate (only SBW Type).

Anti-lock Brake System (ABS)

The Anti-lock Brake System (ABS) prevents the wheels from locking. So the vehicle remains stable and can still be steered.

ABS (or ESC) will not prevent accidents due to improper or dangerous driving manoeuvres. Even though vehicle control is improved during emergency braking, always maintain a safe distance between you and objects ahead. Vehicle speeds should always be reduced during extreme road conditions. The vehicle should be driven at reduced speeds in the following circumstances:

- When driving on rough, gravel or snow-covered roads
- When driving with tyre chains installed
- When driving on roads where the road surface is pitted or has different surface heights.

Driving in these conditions increases the stopping distance for your vehicle.

The ABS continuously senses the speed of the wheels. If the wheels are going to lock, the ABS repeatedly modulates the hydraulic brake pressure to the wheels.

When you apply your brakes under conditions which may lock the wheels, you may hear a "tik-tik" sound from the brakes, or feel a corresponding sensation in the brake pedal. This is normal and it means your ABS is active.

In order to obtain the maximum benefit from your ABS in an emergency situation, do not attempt to modulate your brake pressure and do not try to pump your brakes. Press your brake pedal as hard as possible to allow the ABS to control the force being delivered to the brakes.

* NOTICE

A click sound may be heard in the vehicle compartment when the vehicle begins to move after the vehicle is started. These conditions are normal and indicate that the Anti-lock Brake System is functioning properly.

Even with the Anti-lock Brake System, your vehicle still requires sufficient stopping distance. Always maintain a safe distance from the vehicle in front of you.

Always slow down when cornering. The Anti-lock Brake System cannot prevent accidents resulting from excessive speeds.

On loose or uneven road surfaces, operation of the Anti-lock Brake System may result in a longer stopping distance than for vehicles equipped with a conventional brake system.

The ABS warning light will stay on for approximately 3 seconds after the ENGINE START/STOP button is ON.



During that time, the ABS will go through self-diagnosis and the light will go off if everything is normal. If the light stays on, you may have a

problem with your ABS. Contact a professional workshop as soon as possible. Kia recommends to visit an authorised Kia dealer/service partner.

When you drive on a road having poor traction, such as an icy road, and have operated your brakes continuously, the ABS will be active continuously and the ABS warning light may illuminate. Pull your vehicle over to a safe place and stop the vehicle.

Restart the vehicle. If the ABS warning light goes off, then your ABS is normal. Otherwise, you may have a problem with the ABS. Contact a professional workshop as soon as possible. Kia recommends to visit an authorised Kia dealer/service partner.

* NOTICE

When you jump start your vehicle because of a drained battery, the vehicle may not run as smoothly and the ABS warning light may turn on at the same time. This happens because of low battery voltage. It does not mean your ABS has malfunctioned.

- Do not pump your brakes!
- Have the battery recharged before driving the vehicle.

Electronic Stability Control (ESC) system

The Electronic Stability Control (ESC) is designed to stabilise the vehicle during cornering manoeuvres.

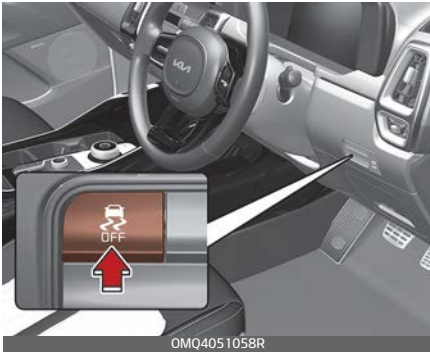

ESC applies the brakes on individual wheels and intervenes with the vehicle management system to stabilise the vehicle.

ESC will not prevent accidents. Excessive speed in turns, abrupt manoeuvres and hydroplaning on wet surfaces can still result in serious accidents.

Only a safe and attentive driver can prevent accidents by avoiding manoeuvres that cause the vehicle to lose traction. Even with ESC installed, always follow all the normal precautions for driving - including driving at safe speeds for the conditions.

⚠ WARNING

For maximum protection, always wear your seat belt. No system, no matter how advanced, can compensate for all driver error and/or driving conditions. Always drive responsibly.

The ESC system is an electronic system designed to help the driver maintain vehicle control under adverse conditions. It is not a substitute for safe driving practices. Factors including speed, road conditions and driver steering input can all affect whether ESC will be effective in preventing a loss of control. It is still your responsibility to drive and corner at reasonable speeds and to leave a sufficient margin of safety.

When you apply your brakes under conditions which may lock the wheels, you may hear a "tik-tik" sound from the brakes, or feel a corresponding sensation in the brake pedal. This is normal and it means your ESC is active.

* NOTICE

A click sound may be heard in the vehicle compartment when the vehicle begins to move after the vehicle is started. These conditions are normal and indicate that the

Electronic Stability Control system is functioning properly.

ESC operation

ESC ON condition

- When the ENGINE START/STOP button is turned ON, ESC and ESC OFF indicator lights illuminate for approximately 3 seconds, then ESC is turned on.
- Press the ESC OFF button for at least half a second after turning the vehicle ON to turn ESC off. (ESC OFF indicator will illuminate). To turn the ESC on, press the ESC OFF button (ESC OFF indicator light will go off).
- When starting the vehicle, you may hear a slight ticking sound. This is the ESC performing an automatic system self-check and does not indicate a problem.

When operating



When the ESC is in operation, the ESC indicator light blinks. When the Electronic Stability Control is operating properly, you can feel a slight pulsation in the vehicle. This is only the effect of brake control and indicates nothing unusual. When moving out of the mud or driving on a slippery road, pressing the accelerator pedal may not cause the vehicle rpm (revolutions per minute) to increase.

ESC operation off





This vehicle has 2 kinds of ESC off states.

If the vehicle stops when ESC is off, ESC remains off. Upon restarting the vehicle, the ESC will automatically turn on again.





ESC off state 1

To turn off the traction control function and only operate the brake control function of the ESC, press the ESC OFF button (ESC OFF ) for less than 3 seconds and the ESC OFF indicator light (ESC OFF ) will illuminate.



ESC off state 2

To turn off the traction control function and the brake control function of the ESC, press the ESC OFF button (ESC OFF ) for more than 3 seconds. ESC OFF indicator light (ESC OFF ) will illuminate and ESC OFF warning chime will sound. At this state, the vehicle stability control function does not operate any more.

Indicator light

ESC indicator light



ESC OFF indicator light



When ENGINE START/STOP button is turned to ON, the indicator light illuminates, then goes off if the ESC system is operating normally.

The ESC indicator light blinks whenever ESC is operating or illuminates when ESC fails to operate.

The ESC OFF indicator light comes on when the ESC is turned off with the button.

WARNING

Electronic Stability Control

Drive carefully even though your vehicle has Electronic Stability Control. It can only assist you in maintaining control under certain circumstances.

ESC OFF usage

When driving

- ESC should be turned on for daily driving whenever possible.
- To turn ESC off whilst driving, press the ESC OFF button whilst driving on a flat road surface.

WARNING

Operating ESC

Never press the ESC OFF button whilst ESC is operating (ESC indicator light blinks).

If ESC is turned off whilst ESC is operating, the vehicle may slip out of control.

* NOTICE

- When operating the vehicle on a dynamometer, ensure that the ESC is turned off (ESC OFF light illuminated). If the ESC is left on, it may prevent the vehicle speed from increasing, and result in false diagnosis.
- Turning the ESC off does not affect ABS or brake system operation.

Downhill Brake Control (DBC)



The Downhill Brake Control (DBC) feature assists the driver to descend down a steep hill without having to depress the brake pedal.

The system automatically applies the brakes to maintain the vehicle speed 4 km/h (2.5 mph) ~ 40 km/h (25 mph) and allows the driver to concentrate on steering the vehicle down hill.





Always turn off the DBC on normal roads. The DBC might activate inadvertently from the stand by mode when driving through speed bumps or making sharp curves.

* NOTICE

The DBC defaults to the OFF position whenever the ignition switch is placed in the ON position. Noise or vibration may occur from the brakes when the DBC is activated.

The rear stop light comes on when DBC is activated.

DBC operation

Mode	Indicator light	Description
Standby	 illuminated	Press the DBC button when vehicle speed is under 60 km/h (38 mph). The DBC system will turn ON and enter the standby mode. The system does not turn ON if vehicle speed is over 60 km/h (38 mph).
Activated	 blinks	In the standby mode, It enters the operating mode when the following conditions are met. <ul style="list-style-type: none"> • The road surface should be more than a certain angle of inclination • The accelerator pedal must not be depressed. • The vehicle speed should be within 4 km/h (2.5 mph) ~ 40 km/h (25 mph) <ul style="list-style-type: none"> - 2.5 km/h (1.5 mph) ~ 8 km/h (5 mph) in case of backward movement Within operating vehicle speed 4 km/h (2.5 mph) ~ 40 km/h (25 mph), the driver can lower or raise the vehicle speed by stepping on the brake pedal or accelerator pedal.
Temporarily deactivated	 illuminated	In the activated mode, the DBC will temporarily deactivate under the following conditions: <ul style="list-style-type: none"> • The hill is not steep enough. • The accelerator pedal is depressed. • When the vehicle speed is in the range of 40 km/h (25 mph) ~ 60 km/h (38 mph) If the above conditions are not met, the DBC will automatically activate again.
OFF	 not illuminated	The DBC will turn OFF under the following conditions: <ul style="list-style-type: none"> • The DBC button is pressed again. • When the accelerator pedal is depressed and the vehicle speed exceeds 60 km/h (38 mph)

⚠ WARNING

If the DBC yellow indicator light illuminates, the system may have overheated or have malfunctioned. When the warning light illuminates even though the DBC system has cooled off, have your vehicle checked by an authorised Kia dealer/service partner as soon as possible.

*** NOTICE**

- The DBC may not deactivate on steep inclines even though the brake or accelerator pedal is depressed.
- The DBC does not operate when:
 - The gear is in P (Park).
 - The ESC is activated.

Hill-start Assist Control (HAC)

A vehicle has the tendency to roll back on a steep hill when it starts to go after stopping. The Hill-start Assist Control (HAC) prevents the vehicle from rolling back by applying the brakes automatically for about 2 seconds.

The brakes are released when the accelerator pedal is engaged or after about 2 seconds.

The HAC is activated only for about 2 seconds, so when the vehicle is

starting off always engaged the accelerator pedal.

⚠ WARNING**Maintaining Brake Pressure on Incline**

HAC does not replace the need to apply brakes whilst stopped on an incline. Whilst stopped, make sure you maintain brake pressure sufficient to prevent your vehicle from rolling backward and causing an accident. Don't release the brake pedal until you are ready to accelerate forward.

Multi-Collision Brake (MCB) (if equipped)

Multi-Collision Brake controls the brake automatically in the event of an accident where the air bag deploys to reduce the risk of additional accidents that may occur.

Function operation

- From the time the air bag deploys, Multi-Collision Brake monitors the depression intensity of the brake pedal and accelerator pedal for a short period. The system operates when the following conditions are met:
 - Vehicle speed is under 180 km/h (112mph) at the time of collision.

- The brake pedal and accelerator pedal is hardly depressed.
- When the driver steps on the brake pedal over a certain level whilst Multi-Collision Brake System is active, the braking power takes priority over automatic braking by Multi-Collision Brake system. However, if the driver takes his/her foot off the brake pedal, Multi-Collision Brake system will maintain automatic braking.

Function off

Multi-Collision Brake is cancelled in the following situations:

- The accelerator pedal is depressed over a certain level.
- The vehicle stops.
- ESC (Electronic Stability Control) or electronic devices has malfunctioned.
- In a situation system cannot operate normally.
- Ten seconds have passed since the brake has been controlled automatically by Multi-Collision Brake system.

⚠ WARNING

- Multi-Collision Brake decreases vehicle speed after a collision and reduces the risk of a second collision, but it does not prevent a second collision. You may drive away from the collision spot to

avoid other dangerous situations by depressing the accelerator pedal.

- After the vehicle is stopped by Multi Collision Brake, the system stops controlling the brakes. Depending on the situation, the driver should depress the brake or the accelerator pedal to prevent a further accident.

Vehicle Stability Management (VSM) system

The Vehicle Stability Management (VSM) provides further enhancements to vehicle stability and steering responses under the following condition:

- when driving on a slippery road or
- when a change in the coefficient of friction between left and right wheels is detected.

⚠ WARNING

Tyre/Wheel size

When replacing tyres and wheels, make sure they are the same size as the original tyres and wheels installed. Driving with varying tyre or wheel sizes may diminish any supplemental safety benefits of the VSM system.

VSM operation

When the VSM is operating properly, you can feel a slight pulsation in the vehicle and/or abnormal steering responses (Electric Power Steering (EPS)). This is only the effect of brake and EPS control and indicates nothing unusual.

The VSM does not operate when:

- Driving on a sloping road such as a gradient or incline
- Driving in reverse
- ESC OFF indicator light () remains on the instrument cluster
- EPS indicator light remains on the instrument cluster

VSM operation off

If you press the ESC OFF button to turn off the ESC, the VSM will also cancel and the ESC OFF indicator light () illuminates.

To turn on the VSM, press the button again. The ESC OFF indicator light goes out.

⚠ WARNING

Vehicle Stability Management

Drive carefully even though your vehicle has Vehicle Stability Management. It can only assist you in maintaining control of the vehicle under certain circumstances.

Malfunction indicator

The VSM can be deactivated even if you don't cancel the VSM operation by pressing the ESC OFF button. It indicates that a malfunction has been detected somewhere in the Electric Power Steering system or VSM system. If the ESC indicator light () or EPS warning light remains on, take your vehicle to a professional workshop and have the system checked. Kia recommends to visit an authorised Kia dealer/service partner.

The VSM is not a substitute for safe driving practices but a supplementary function only. It is the responsibility of the driver to always check the speed and the distance to the vehicle ahead. Always hold the steering wheel firmly whilst driving.

Your vehicle is designed to activate according to the driver's intention, even with installed VSM. Always follow all the normal precautions for driving at safe speeds for the conditions – including driving in clement weather and on a slippery road.

WARNING

For maximum protection, always wear your seat belt. No system, no matter how advanced, can compensate for all driver error and/or driving conditions. Always drive responsibly.

Emergency Stop Signal (ESS)

The Emergency Stop Signal system alerts the driver behind by blinking the stop lights, whilst sharply and severely braking.

The system is activated when:

- The vehicle suddenly stops. (The deceleration power exceeds 7 m/s^2 , and the driving speed exceeds 55 km/h (34 mph).)
- The ABS is activated and the driving speed exceeds 55 km/h (34 mph).

The hazard warning flasher automatically turns ON after blinking the stop lights:

- When the driving speed is under 40 km/h (25 mph),
- When the ABS is deactivated, and
- When the sudden braking situation is over.

The hazard warning flasher turns OFF:

- When the vehicle drives at a low speed for a certain period of time.

The driver can manually turn OFF the hazard warning flasher by pressing the button.

* NOTICE

The Emergency Stop Signal (ESS) system will not activate, when the hazard warning flashers are already on.

Trailer Stability Assist (TSA) system

The Trailer Stability Assist (TSA) is operated as a vehicle stability control system. The TSA is designed to stabilise the vehicle and trailer when the trailer sways or oscillates. There are various factors that make the vehicle sway or oscillate.

Such incidents mostly happen at high speed, but, there is also a risk of swaying when the trailer is affected by crosswinds, buffeting or improper overloading.

Factors of swaying such as:

- High speed
- Strong crosswinds
- Improper overloading
- Sudden controlling of steering wheel
- Uneven road

The TSA continuously analyzes the vehicle and trailer instability. When the TSA detects some sway, the brakes are applied automatically to stabilise the vehicle. When the vehicle becomes stable, the TSA does not operate.

Brake Assistant System (BAS)

The Brake Assistant System provides additional pressure when the brake pedal is momentarily and strongly depressed in a situation sudden braking is required while driving.

The Brake Assistant System reduces the time for ABS (Anti-Lock Brake System) control to enter and consequently reduces the braking distance, by providing additional pressure up to the point of ABS intervention.

BAS operation

- When the vehicle speed is more than 30 km/h and the ABS control is not entered.
- When the brake pedal is depressed strongly over a certain level.

- When the friction of the road surface is above a certain level.

BAS operation off

- The vehicle speed is below 10 km/h.
- The brake pedal is depressed over a certain conditions.
- The friction of the road surface is below a certain level.

⚠ WARNING

The system may not operate depending on driver's driving habit, the degree to which the brake pedal is depressed and the road surface condition.

Good braking practices

Good braking practices help keep occupants safe and extend brake life.

- Check to be sure the parking brake is not engaged and the parking brake indicator light is out before driving away.
- Driving through water may get the brakes wet. They can also get wet when the vehicle is washed. Wet brakes can be dangerous! Your vehicle will not stop as quickly if the brakes are wet. Wet brakes may cause the vehicle to pull to one side. To dry the brakes, apply the brakes lightly until the braking

action returns to normal, taking care to keep the vehicle under control at all times. If the braking action does not return to normal, stop as soon as it is safe to do so and call a professional workshop for assistance. Kia recommends to visit an authorised Kia dealer/service partner.

- Don't coast down hills with the vehicle out of gear. This is extremely hazardous. Keep the vehicle in gear at all times, use the brakes to slow down, then shift to a lower gear so that vehicle braking will help you maintain a safe speed.
- Don't "ride" the brake pedal. Resting your foot on the brake pedal whilst driving can be dangerous because the brakes might overheat and lose their effectiveness. It also increases the wear of the brake components.
- If a tyre goes flat whilst you are driving, apply the brakes gently and keep the vehicle pointed straight ahead whilst you slow down. When you are moving slowly enough for it to be safe to do so, pull off the road and stop in a safe place.
- Be cautious when parking on a hill. Firmly engage the parking brake and place the dial SBW in P. If your vehicle is facing downhill, turn the front wheels into the kerb to help keep the vehicle from rolling.

If your vehicle is facing uphill, turn the front wheels away from the kerb to help keep the vehicle from rolling. If there is no kerb or if it is required by other conditions to keep the vehicle from rolling, block the wheels.

- Under some conditions your parking brake can freeze in the engaged position. This is most likely to happen when there is an accumulation of snow or ice around or near the rear brakes or if the brakes are wet. If there is a risk that the parking brake may freeze, apply it only temporarily whilst you put the dial SBW in P and block the rear wheels so the vehicle cannot roll. Then release the parking brake.
- Do not hold the vehicle on an incline with the accelerator pedal. This can cause the transmission to overheat. Always use the brake pedal or parking brake.

Drive mode integrated control system

Drive mode

The drive mode may be selected according to the driver's preference or road condition.



* NOTICE

If there is a problem with the instrument cluster, the drive mode will be in ECO mode and may not change to SMART mode or SPORT mode.

The mode changes when you toggle the DRIVE MODE button.

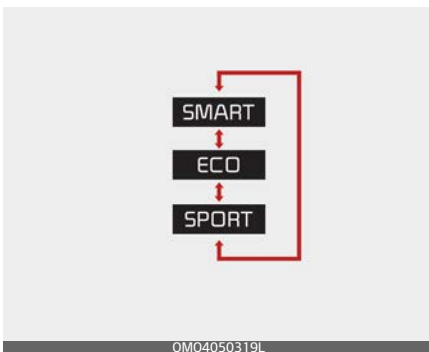

- ECO mode:
ECO mode helps improve fuel efficiency for eco-friendly driving.
- SPORT mode:
SPORT mode provides sporty but firm riding.

The drive mode will change to COMFORT mode when the engine is restarted. However, except when it is in ECO mode and SMART mode. ECO mode and SMART mode will be maintained, as selected when the engine is restarted.

When changing the drive mode setting, the responsiveness of Smart Cruise Control changes. (If equipped)

Drive Mode	SCC Responsiveness
ECO	Slow
SPORT	Fast
SMART	Normal

ECO mode

ECO When the Drive Mode is set to ECO mode, the engine and transmission control logic are changed to maximise fuel efficiency.

FWD vehicle



AWD vehicle (if equipped)



- When the ECO mode is selected by using the DRIVE MODE button, the ECO indicator will illuminate.
- Whenever the engine is restarted, the drive mode remains in ECO mode.

* NOTICE

Fuel efficiency depends on the driver's driving habit and road condition.

When ECO mode is activated:

- The acceleration response may be slightly reduced as the accelerator pedal is depressed moderately.
- The air conditioner performance may be limited.
- The shift pattern of the automatic transmission may change.
- The engine noise may get louder.

The above situations are normal conditions when ECO mode is activated to improve fuel efficiency.

Limitation of ECO mode operation:

If the following conditions occur whilst ECO mode is operating, the system operation is limited even though there is no change in ECO indicator.

- When the coolant temperature is low:
The system will be limited until engine performance becomes normal.
- When driving up a hill:
The system will be limited to gain power when driving uphill because engine torque is restricted.
- When the accelerator pedal is deeply depressed for a few seconds:

The system will be limited, judging that the driver wants to speed up.

SPORT mode

SPORT SPORT mode manages the driving dynamics by automatically adjusting the steering effort, the engine and transmission control logic for enhanced driver performance.

FWD vehicle



AWD vehicle (if equipped)



- Whenever the engine is restarted, the Drive Mode will revert back to ECO mode. If SPORT mode is desired, re-select SPORT mode from the DRIVE MODE button.
- When SPORT mode is activated:
 - The engine rpm will tend to remain raised over a certain length of time even after releasing the accelerator
 - Upshifts are delayed when accelerating

*** NOTICE**

In SPORT mode, the fuel efficiency may decrease.

SMART mode

SMART SMART mode selects the proper driving mode among ECO and SPORT by judging the driver's driving habits (i.e. Economic or Aggressive (Sportive)) from the brake pedal depression or the steering wheel operation.

- When SPORT mode is selected by using the DRIVE MODE button, the SPORT indicator will illuminate.

FWD vehicle



AWD vehicle (if equipped)



*** NOTICE**

- When you mildly drive the vehicle in SMART mode, the driving mode changes to ECO mode to improve fuel efficiency. However, the actual fuel efficiency may differ in accordance with your driving situations (i.e. upward/downward slope, vehicle deceleration/acceleration).
- When you dynamically drive the vehicle in SMART mode by abruptly decelerating or sharply turning the driving mode changes to SPORT mode. However, it may adversely affect fuel economy.

Various driving situations, which you may encounter in SMART mode

- Toggle the DRIVE MODE button to select SMART mode. When SMART mode is selected, the indicator illuminates on the instrument cluster.
- SMART mode automatically controls the vehicle driving, such as gear shifting patterns and engine torque, in accordance with the driver's driving habits.
- The driving mode automatically changes to ECO mode after a certain period of time, when you gently depress the accelerator pedal. (Your driving is categorised to be economic.)
- The driving mode automatically changes to SMART ECO mode after a certain period of time, when you sharply or repetitively depress the accelerator pedal.
- The driving mode automatically changes to SMART ECO mode with the same driving patterns, when the vehicle starts to drive on an upward slope of a certain angle. The driving mode automatically returns to SMART ECO

mode, when the vehicle enters a leveled road.

- The driving mode automatically changes to SMART SPORT, when you abruptly accelerate the vehicle or repetitively operate the steering wheel. (Your driving is categorised to be sporty.) In this mode, your vehicle drives in a lower gear for abrupt accelerating/decelerating and increases the engine brake performance.
- You may still sense the engine braking performance, even when you release the accelerator pedal in SMART SPORT mode. It is because your vehicle remains in lower gear over a certain period of time for next acceleration. Thus, it is a normal driving situation, not indicating any malfunction.
- The driving mode automatically changes to SMART SPORT mode only in harsh driving situations. In most of the normal driving situations, the driving mode sets to be in SMART ECO mode.

Limitation of SMART mode

The SMART mode may be limited in following situations. (The OFF indicator illuminates in those situations.)

- Cruise Control is activated:
Cruise Control may deactivate the SMART mode when the vehicle is controlled by the set speed of Smart Cruise Control. (SMART mode is not deactivated just by activating Cruise Control.)
- The transmission oil temperature is either extremely low or extremely high:
The SMART mode can be active in most of the normal driving situations. However, an extremely high/ low transmission oil temperature may temporarily deactivate the SMART mode, because the transmission condition is out of normal operation condition.

Smart shift on trip computer (if equipped)

Select the Trip Computer mode on the instrument cluster LCD display and move to the smart shift screen. Then, the driver can see the drive mode selected and the drive mode which is automatically switched by the SMART mode.



The drive mode selected by the driver and the driving style gauge showing the driver's driving style are displayed on the screen.

Driver's style gauge in SMART mode



With the standard driving style in the centre, the left side of the gauge is 'Econ.' and right side is 'Dynamic' style.

When the left side of the driver's style gauge is filled up and after a certain time passes, the SMART ECO mode is activated automatically. When the right side of the gauge is filled up and sporty driving condition is detected, the SMART SPORT mode is activated.

To maintain the SMART ECO mode for fuel efficiency, drive with the left side of the gauge filled up.

Forward Collision-Avoidance Assist (FCA) (Front view camera only) (if equipped)

Basic function

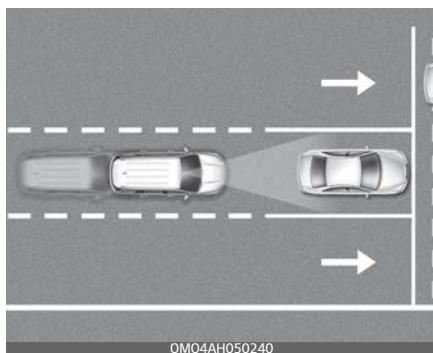

Forward Collision-Avoidance Assist is designed to help detect and monitor the vehicle ahead or help detect a pedestrian in the roadway and warn the driver that a collision is imminent with a warning message and an audible warning, and if necessary, apply emergency braking.

Detecting sensor

Front view camera



⚠ CAUTION

Take the following precautions to maintain optimal performance of the detecting sensor:

- Never disassemble the detecting sensor or sensor assembly, or apply any impact on it.
- Never install any accessories or stickers on the front windscreen, or tint the front windscreen.
- If the detecting sensors have been replaced or repaired, Kia recommends to visit an authorised Kia dealer/service partner.
- Pay extreme caution to keep the front view camera dry.
- Never place any reflective objects (i.e. white paper, mirror) over the dashboard. Any light reflection may prevent the function from functioning properly.

Forward Collision-Avoidance Assist settings

Setting

Forward Safety



With the ENGINE START/STOP button in the ON position, select or deselect 'Driver Assistance → Forward Safety' from the Settings menu to set whether or not to use each function.

- If 'Active Assist' is selected, the function will warn the driver with a warning message, an audible warning and steering wheel vibration depending on the collision risk levels. Braking assist will be applied depending on the collision risk.
- If 'Warning Only' is selected, the function will warn the driver with a warning message, an audible warning and steering wheel vibration depending on the collision risk levels. Braking will not be assisted.

- If 'Off' is selected, the function will be turned off. The (🚗) warning light will illuminate on the cluster.

The driver can monitor Forward Collision-Avoidance Assist ON/OFF status from the Settings menu. If the (🚗) warning light remains ON when the function is ON, Kia recommends to visit an authorised Kia dealer/service partner.

⚠️ WARNING

When the engine is restarted, Forward Collision-Avoidance Assist will always turn on. However, if 'Off' is selected after the engine is restarted, the driver should always be aware of the surroundings and drive safely.

⚠️ CAUTION

- If 'Warning Only' is selected, braking is not assisted.
- Steering wheel vibration can be turned on or off. Select or deselect 'Driver Assistance → Haptic Warning' from the Settings menu.

*** NOTICE**

Forward Collision-Avoidance Assist will turn off when ESC is turned off by pressing and holding the ESC OFF button. The (🚗💡) warning light will illuminate on the cluster.

Warning timing



OMQ4AH050334

With the ENGINE START/STOP button in the ON position, select 'Driver Assistance → Warning Timing' from the Settings menu to change the initial warning activation time for Forward Collision-Avoidance Assist.

When the vehicle is first delivered, Warning Timing is set to 'Normal'. If you change the Warning Timing, the warning time of other Driver Assistance systems may change.

Warning volume



OMQ4041606

With the ENGINE START/STOP button in the ON position, select 'Driver Assistance → Warning Volume' from the Settings menu to change the Warning Volume to 'High', 'Medium', 'Low' or 'Off' for Forward Collision-Avoidance Assist.

However, even if 'Off' is selected, the function's Warning Volume will not turn off but the volume will sound as 'Low'.

If you change the warning volume, the Warning Volume of other Driver Assistance systems may change.

⚠ CAUTION

- The setting of the Warning Timing and Warning Volume applies to all functions of Forward Collision-Avoidance Assist.
- Even though 'Normal' is selected for Warning Timing, if the front vehicle suddenly stops, the initial

warning activation time may seem late.

- Select 'Late' for Warning Timing when traffic is light and when driving speed is slow.

* NOTICE

If the engine is restarted, Warning Timing and Warning Volume will maintain the last setting.

Forward Collision-Avoidance Assist Operation

Warning and control

The basic function for Forward Collision-Avoidance Assist is to warn and control the vehicle depending on the collision level: 'Collision Warning', 'Emergency Braking' and 'Stopping vehicle and ending brake control'.

Collision warning



Forward Collision-Avoidance Assist (FCA) (Front view camera only)

- To warn the driver of a collision, the 'Collision Warning' warning message will appear on the cluster, an audible warning will sound and the steering wheel will vibrate.
- If a vehicle is detected in front, the function will operate when your vehicle speed is between approximately 10 ~ 180 km/h (6 ~ 112 mph).
- If a pedestrian is detected in front, the function will operate when your vehicle speed is between approximately 10 ~ 60 km/h (6 ~ 37 mph).
- If 'Active Assist' is selected, braking may be assisted.

Emergency braking



- To warn the driver that emergency braking will be assisted, the 'Emergency Braking' warning message will appear on the cluster, an audible warning will sound and the steering wheel will vibrate.

Driving your vehicle

- If a vehicle is detected in front, the function will operate when your vehicle speed is between approximately 10 ~ 60 km/h (6 ~ 37 mph).
- If a pedestrian is detected in front, the function will operate when your vehicle speed is between approximately 10 ~ 60 km/h (6 ~ 37 mph).
- In emergency braking situation, braking is assisted with strong braking power by the function to help prevent collision with the vehicle or pedestrian.

Stopping vehicle and ending brake control



0MQ4040504R

- When the vehicle is stopped due to emergency braking, the 'Drive carefully' warning message will appear on the cluster.
- For your safety, the driver should depress the brake pedal immediately and check the surroundings.
- Brake control will end after the vehicle is stopped by emergency

Forward Collision-Avoidance Assist (FCA) (Front view camera only)

braking for approximately 2 seconds.

⚠ WARNING

- For your safety, change the Settings after parking the vehicle at a safe location.
- With 'Active Assist' or 'Warning Only' selected, when ESC is turned off by pressing and holding the ESC OFF button, Forward Collision-Avoidance Assist will turn off automatically. In this case, the function cannot be set from the Settings menu and the warning light will illuminate on the cluster which is normal. If ESC is turned on by pressing the ESC OFF button, Forward Collision-Avoidance Assist will maintain the last setting.
- Forward Collision-Avoidance Assist does not operate in all situations or cannot avoid all collisions.
- The driver should hold the responsibility to control the vehicle. Do not solely depend on Forward Collision-Avoidance Assist. Rather, maintain a safe braking distance, and if necessary, depress the brake pedal to reduce driving speed or to stop the vehicle.
- Never deliberately operate Forward Collision-Avoidance Assist

on people, animal, objects, etc. It may cause serious injury or death.

- Forward Collision-Avoidance Assist may not operate if the driver depresses the brake pedal to avoid collision.
 - Depending on the road and driving conditions, Forward Collision-Avoidance Assist may warn the driver late or may not warn the driver.
 - During Forward Collision-Avoidance Assist operation, the vehicle may stop suddenly injuring passengers and shifting loose objects. Always have the seat belt on and keep loose objects secured.
 - If any other function's warning message is displayed or audible warning is generated, Forward Collision-Avoidance Assist warning message may not be displayed and audible warning may not be generated.
 - You may not hear the warning sound of Forward Collision-Avoidance Assist if the surrounding is noisy.
 - Forward Collision-Avoidance Assist may turn off or may not operate properly or may operate unnecessarily depending on the road conditions and the surroundings.
-

*** NOTICE**

- Even if there is a problem with Forward Collision-Avoidance Assist, the vehicle's basic braking performance will operate normally.
 - During emergency braking, braking control by the function will automatically cancel when the driver excessively depresses the accelerator pedal or sharply steers the vehicle.
-

⚠ CAUTION

Depending on the condition of the vehicle, pedestrian in front and the surroundings, the speed range to operate Forward Collision-Avoidance Assist may reduce. The function may only warn the driver, or the function may not operate.

*** NOTICE**

In a situation collision is imminent, braking may be assisted by Forward Collision-Avoidance Assist when braking is insufficient by the driver. Depending on the instrument panel specifications or theme, images or colours may be displayed differently.

Forward Collision-Avoidance Assist Malfunction and Limitations

Forward Collision-Avoidance Assist malfunction



When Forward Collision-Avoidance Assist is not working properly, the 'Check Forward Safety system' warning message will appear, and the (⚠) and (🚗) warning lights will illuminate on the cluster. Have the function be inspected by an authorised Kia dealer/service partner.

Forward Collision-Avoidance Assist disabled



When the front windscreen where the front view camera is located, is covered with foreign material, such as snow or rain, it can reduce the detecting performance and temporarily limit or disable Forward Collision-Avoidance Assist.

If this occurs, the 'Forward Safety Function disabled. Camera obscured' warning message, and the (⚠) and (🚗) warning lights will illuminate on the cluster.

The function will operate normally when snow, rain or foreign matter is removed. Always keep it clean.

If the function does not operate normally after obstruction (snow, rain, or foreign material) is removed, have the function be inspected by an authorised Kia dealer/service partner.

*** NOTICE**

- Even though the warning message or warning light does not appear on the cluster, Forward Collision-Avoidance Assist may not properly operate.
 - Forward Collision-Avoidance Assist may not properly operate in an area (e.g. open terrain), where any substance are not detected after turning ON the engine.
-

Limitations of Forward Collision-Avoidance Assist

Forward Collision-Avoidance Assist may not operate normally, or the function may operate unexpectedly under the following circumstances:

- The detecting sensor or the surroundings are contaminated or damaged
- The temperature around the front view camera is high or low
- The camera lens is contaminated due to tinted, filmed or coated windscreen, damaged glass, or stuck of foreign material (sticker, bug, etc.) on the glass
- Moisture is not removed or frozen on the windscreen
- Washer fluid is continuously sprayed, or the wiper is on
- Driving in heavy rain or snow, or thick fog

- The field of view of the front view camera is obstructed by sun glare
- Street light or light from an oncoming vehicle is reflected on the wet road surface, such as a puddle on the road
- An object is placed on the dashboard
- Your vehicle is being towed
- The surrounding is very bright
- The surrounding is very dark, such as in a tunnel, etc.
- The brightness changes suddenly, for example when entering or exiting a tunnel
- The brightness outside is low, and the headlamps are not on or are not bright
- Driving through steam, smoke or shadow
- Only part of the vehicle, pedestrian is detected
- The vehicle in front is a bus, heavy truck, truck with a unusually shaped luggage, trailer, etc.
- The vehicle in front has no taillamps, taillamps are located unusually, etc.
- The brightness outside is low, and the taillamps are not on or are not bright
- The rear of the front vehicle is small or the vehicle does not look normal, such as when the vehicle is tilted, overturned, or the side of the vehicle is visible, etc.
- The front vehicle's ground clearance is low or high

Driving your vehicle

- A vehicle or pedestrian suddenly cuts in front
- The vehicle in front is detected late
- The vehicle in front is suddenly blocked by an obstacle
- The vehicle in front suddenly changes lane or suddenly reduces speed
- The vehicle in front is bent out of shape
- The front vehicle's speed is fast or slow
- The vehicle in front steers in the opposite direction of your vehicle to avoid a collision
- With a vehicle in front, your vehicle changes lane at low speed
- The vehicle in front is covered with snow
- You are departing or returning to the lane
- Unstable driving
- You are on a roundabout and the vehicle in front is not detected
- You are continuously driving in a circle
- The vehicle in front has an unusual shape
- The vehicle in front is driving uphill or downhill.
- The pedestrian is not fully detected, for example, if the pedestrian is leaning over or is not fully walking upright
- The pedestrian is wearing clothing or equipment that makes it difficult to detect as a pedestrian

Forward Collision-Avoidance Assist (FCA) (Front view camera only)

Following image shows the image the sensor recognises as vehicle and pedestrian.



- The pedestrian in front is moving very quickly
- The pedestrian in front is short or is posing a low posture
- The pedestrian in front has impaired mobility
- The pedestrian in front is moving intersected with the driving direction
- There is a group of pedestrians or a large crowd in front
- The pedestrian is wearing clothing that easily blends into the background, making it difficult to detect
- The pedestrian is difficult to distinguish from the similar shaped structure in the surroundings
- You are driving by a pedestrian, traffic signs, structures, etc. near the intersection
- You are driving by a pedestrian, traffic signs, structures, etc. near the intersection
- Driving in a parking lot

Driving your vehicle

- Driving through a tollgate, construction area, unpaved road, partial paved road, uneven road, speed bumps, etc.
- Driving on an incline road, curved road, etc.
- Driving through a roadside with trees or streetlights
- The adverse road conditions cause excessive vehicle vibrations whilst driving
- Your vehicle height is low or high due to heavy loads, abnormal tyre pressure, etc.
- Driving through a narrow road where trees or grass or overgrown
- There is interference by electromagnetic waves, such as driving in an area with strong radio waves or electrical noise

⚠ WARNING

- Driving on a curve

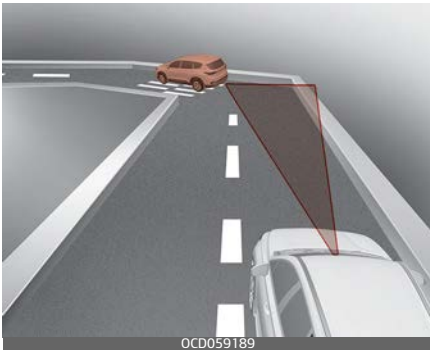

Forward Collision-Avoidance Assist (FCA) (Front view camera only)

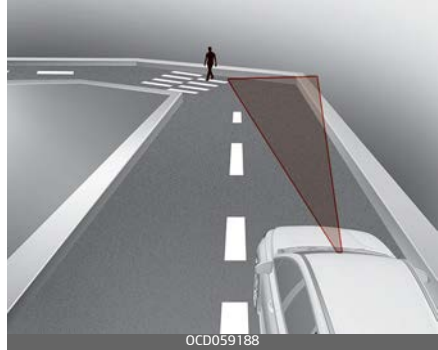

Forward Collision-Avoidance Assist may not detect other vehicles, pedestrians in front of you on curved roads adversely affecting the performance of the sensors. This may result in no warning, braking assist or steering assist when necessary. When driving on a curve, you must maintain a safe braking distance, and if necessary, steer the vehicle and depress the brake pedal to reduce your driving speed in order to maintain a safe distance.

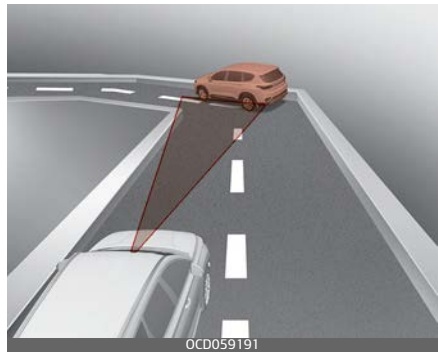

Driving your vehicle

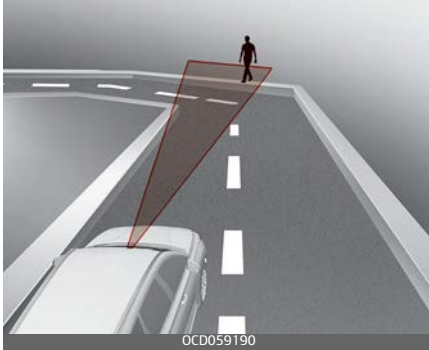

Forward Collision-Avoidance Assist may detect a vehicle, pedestrian in the next lane or outside the lane when driving on a curved road.

If this occurs, the function may unnecessarily warn the driver and control the brake or steering wheel. Always check the traffic conditions around the vehicle.

- Driving on a slope



Forward Collision-Avoidance Assist (FCA) (Front view camera only)



Forward Collision-Avoidance Assist may not detect other vehicles, pedestrians in front of you whilst driving uphill or downhill adversely affecting the performance of the sensors.

This may result in unnecessary warning, braking assist or steering assist or no warning, braking assist or steering assist when necessary.

Also, vehicle speed may rapidly decrease when a vehicle or pedestrian ahead is suddenly detected. Always have your eyes on the road whilst driving uphill or downhill and if necessary, steer your vehicle and depress the brake pedal to reduce your driving speed in order to maintain a safe distance.

- Changing lanes



[A]: Your vehicle
[B]: Lane changing vehicle
When a vehicle [B] moves into your lane from an adjacent lane, it cannot be detected by the sensor until it is in the sensor's detection range. Forward Collision-Avoidance Assist may not immediately detect the vehicle when the vehicle changes lanes abruptly. In this case, you must maintain a safe braking distance, and if necessary, steer your vehicle and depress the brake pedal to reduce your driving speed in order to maintain a safe distance.



[A]: Your vehicle
[B]: Lane changing vehicle,
[C]: Same lane vehicle
When a vehicle [B] in front of you merges out of the lane, Forward Collision-Avoidance Assist may not immediately detect the vehicle [C] that is now in front of you. In this case, you must maintain a safe braking distance, and if necessary, steer your vehicle and depress the brake pedal to reduce your driving speed in order to maintain a safe distance.

- Detecting vehicle

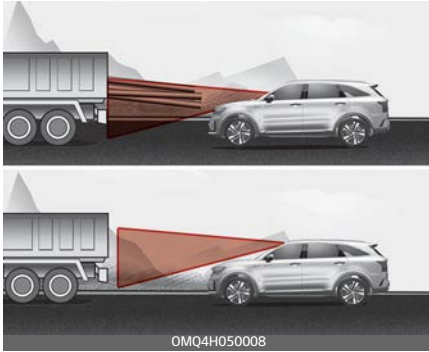

If the vehicle in front of you has cargo that extends rearward from the cab, or when the vehicle in front of you has higher ground clearance, additional special attention is required. Forward Collision-Avoidance Assist may not be able to detect the cargo extending from the vehicle. In these instances, you must maintain a safe braking distance from the rearmost object, and if necessary, steer your vehicle and depress the brake pedal to reduce your driving speed in order to maintain distance.

⚠ WARNING

- When you are towing a trailer or another vehicle, we recommend that Forward Collision-Avoidance Assist is turned off due to safety reasons.
- Forward Collision-Avoidance Assist may operate if objects that are similar in shape or characteristics to vehicles and pedestrians are detected.
- Forward Collision-Avoidance Assist does not operate on motorcycles, or smaller wheeled objects, such as luggage bags, shopping carts, or strollers that are dragged by a pedestrian.
- Forward Collision-Avoidance Assist may not operate normally if interfered by strong electromagnetic waves.
- Forward Collision-Avoidance Assist may not operate for approximately 15 seconds after the vehicle is started, or the front view camera is initialised.

Forward Collision–Avoidance Assist (FCA) (Sensor fusion) (if equipped)

Basic function

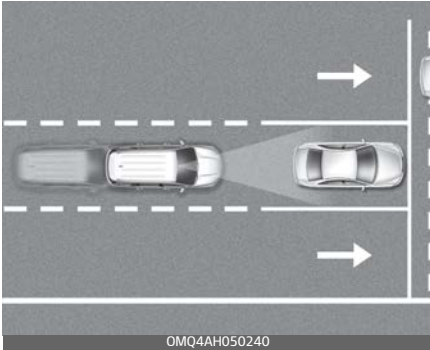

Forward Collision–Avoidance Assist is designed to help detect and monitor the vehicle ahead or help detect a pedestrian or cyclist in the roadway and warn the driver that a collision is imminent with a warning message and an audible warning, and if necessary, apply emergency braking.

Junction Turning function

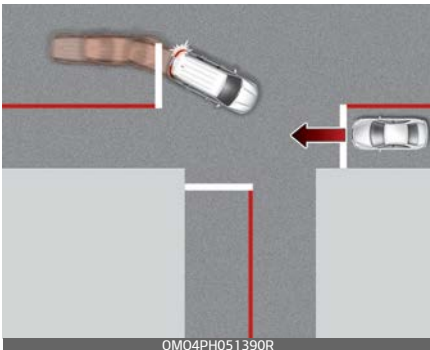

Forward Collision–Avoidance Assist (FCA) (Sensor fusion)

Junction Turning function will help avoid a collision with an oncoming vehicle in an adjacent lane when turning right at a crossroad with the turn signal on by applying emergency braking.

Detecting sensor

Front view camera



Front radar



Refer to the picture above for the detailed location of the detecting sensors.

⚠ CAUTION

Take the following precautions to maintain optimal performance of the detecting sensor:

- Never disassemble the detecting sensor or sensor assembly, or apply any impact on it.
- Never install any accessories or stickers on the front windscreen, or tint the front windscreen.
- If the detecting sensors have been replaced or repaired, have the vehicle be inspected by an authorised Kia dealer/service partner.
- Pay extreme caution to keep the front view camera dry.
- Never place any reflective objects (i.e. white paper, mirror) over the dashboard. Any light reflection may prevent the function from functioning properly.
- Do not apply license plate frame or objects, such as a bumper sticker, film or a bumper guard, near the front radar cover.
- Always keep the front radar and cover clean and free of dirt and debris. Use only a soft cloth to wash the vehicle. Do not spray pressurised water directly on the sensor or sensor cover.
- If unnecessary force has been applied to the radar or around the radar, Forward Collision-Avoidance Assist may not properly operate even though a warning

message does not appear on the cluster. Have the vehicle be inspected by an authorised Kia dealer/service partner.

- Use only genuine parts to repair or replace a damaged front radar cover. Do not apply paint to the front radar cover.

Forward Collision-Avoidance Assist Settings

Setting

Forward Safety



With the ENGINE START/STOP button in the ON position, select or deselect 'Driver Assistance → Forward Safety' from the Settings menu to set whether or not to use each function.

- If 'Active Assist' is selected, the function will warn the driver with a warning message, an audible warning and steering wheel vibration depending on the collision risk

levels. Braking assist will be applied depending on the collision risk.

- If 'Warning Only' is selected, the function will warn the driver with a warning message, an audible warning and steering wheel vibration depending on the collision risk levels. Braking will not be assisted.
- If 'Off' is selected, the function will off. The  warning light will illuminate on the cluster.

The driver can monitor Forward Collision-Avoidance Assist ON/OFF status from the Settings menu. If the  warning light remains ON when the function is ON, have the function be inspected by an authorised Kia dealer/service partner.

WARNING

When the engine is restarted, Forward Collision-Avoidance Assist will always turn on. However, if 'Off' is selected after the engine is restarted, the driver should always be aware of the surroundings and drive safely.

CAUTION

- If 'Warning Only' is selected, braking is not assisted.

- The settings for Forward Safety include 'Basic function' and 'Junction Turning'.
- Steering wheel vibration can be turned on or off. Select or deselect 'Driver Assistance → Haptic Warning' from the Settings menu.

*** NOTICE**

Forward Collision-Avoidance Assist will turn off when ESC is turned off by pressing and holding the ESC OFF button. The  warning light will illuminate on the cluster.

Warning timing



With the ENGINE START/STOP button in the ON position, select 'Driver Assistance → Warning Timing' from the Settings menu to change the initial warning activation time for Forward Collision-Avoidance Assist.

When the vehicle is first delivered, Warning Timing is set to 'Normal'.

If you change the Warning Timing, the warning time of other Driver Assistance systems may change.

Warning volume



OMQ4041606

With the ENGINE START/STOP button in the ON position, select 'Driver Assistance → Warning Volume' from the Settings menu to change the Warning Volume to 'High', 'Medium', 'Low' or 'Off' for Forward Collision-Avoidance Assist.

However, even if 'Off' is selected, the function's Warning Volume will not turn off but the volume will sound as 'Low'.

If you change the warning volume, the Warning Volume of other Driver Assistance systems may change.

⚠ CAUTION

- The setting of the Warning Timing and Warning Volume applies to all functions of Forward Collision-Avoidance Assist.
- Even though 'Normal' is selected for Warning Timing, if the front vehicle suddenly stops, the initial warning activation time may seem late.
- Select 'Late' for Warning Timing when traffic is light and when driving speed is slow.

*** NOTICE**

If the engine is restarted, Warning Timing and Warning Volume will maintain the last setting.

Forward Collision-Avoidance Assist Operation

Basic function

Warning and control

The basic function for Forward Collision-Avoidance Assist is to warn and control the vehicle depending on the collision level: 'Collision Warning', 'Emergency Braking' and 'Stopping vehicle and ending brake control'.

Collision warning



- To warn the driver of a collision, the 'Collision Warning' warning message will appear on the cluster, an audible warning will sound and the steering wheel will vibrate.
- If a vehicle is detected in front, the function will operate when your vehicle speed is between approximately 10 ~ 180 km/h (6 ~ 112 mph).
- If a pedestrian or cyclist is detected in front, the function will operate when your vehicle speed is between approximately 10 ~ 85 km/h (6 ~ 53 mph).
- If 'Active Assist' is selected, braking may be assisted.

Emergency braking



- To warn the driver that emergency braking will be assisted, the 'Emergency Braking' warning message will appear on the cluster, an audible warning will sound and the steering wheel will vibrate.
- If a vehicle is detected in front, the function will operate when your vehicle speed is between approximately 10 ~ 75 km/h (6 ~ 47 mph).
- If a pedestrian or cyclist is detected in front, the function will operate when your vehicle speed is between approximately 10 ~ 65 km/h (6 ~ 40 mph).
- In emergency braking situation, braking is assisted with strong braking power by the function to help prevent collision with the vehicle, pedestrian or cyclist ahead.

Stopping vehicle and ending brake control

- When the vehicle is stopped due to emergency braking, the 'Drive carefully' warning message will appear on the cluster. For your safety, the driver should depress the brake pedal immediately and check the surroundings.
- Brake control will end after the vehicle is stopped by emergency braking for approximately 2 seconds.

Junction Turning function***Function warning and control***

Junction Turning function will warn and control the vehicle depending on the collision level: 'Collision Warning', 'Emergency Braking' and 'Stopping vehicle and ending brake control'.

Collision warning

- To warn the driver of a collision, the 'Collision Warning' warning message will appear on the cluster, an audible warning will sound and the steering wheel will vibrate.
- The function will operate when your vehicle speed is between approximately 10 ~ 30 km/h (6 ~ 19 mph) and the oncoming vehicle speed is between approximately 30 ~ 70 km/h (19 ~ 44 mph).
- The function will operate when the right turn signal switch is operated and turning right.
- If 'Active Assist' is selected, braking may be assisted.

Emergency braking



- To warn the driver that emergency braking will be assisted, the 'Emergency Braking' warning message will appear on the cluster, an audible warning will sound and the steering wheel will vibrate.
- The function will operate when your vehicle speed is between approximately 6 ~ 19 mph (10 ~ 30 km/h) and the oncoming vehicle speed is between approximately 19 ~ 44 mph (30 ~ 70 km/h).
- The function will operate when the right turn signal switch is operated and turning right.
- In emergency braking situation, braking is assisted with strong braking power by the function to help prevent collision with the oncoming vehicle.

Stopping vehicle and ending brake control



- When the vehicle is stopped due to emergency braking, the 'Drive carefully' warning message will appear on the cluster. For your safety, the driver should depress the brake pedal immediately and check the surroundings.
- Brake control will end after the vehicle is stopped by emergency braking for approximately 2 seconds.

⚠ WARNING

- For your safety, change the Settings after parking the vehicle at a safe location.
- With 'Active Assist' or 'Warning Only' selected, when ESC is turned off by pressing and holding the ESC OFF button, Forward Collision-Avoidance Assist will turn off automatically. In this case, the function cannot be set from the Settings menu and the 

warning light will illuminate on the cluster which is normal. If ESC is turned on by pressing the ESC OFF button, Forward Collision-Avoidance Assist will maintain the last setting.

- Forward Collision-Avoidance Assist does not operate in all situations or cannot avoid all collisions.
- The driver should hold the responsibility to control the vehicle. Do not solely depend on Forward Collision-Avoidance Assist. Rather, maintain a safe braking distance, and if necessary, depress the brake pedal to reduce driving speed or to stop the vehicle.
- Never deliberately operate Forward Collision-Avoidance Assist on people, animal, objects, etc. It may cause serious injury or death.
- Forward Collision-Avoidance Assist may not operate if the driver depresses the brake pedal to avoid collision.
- Depending on the road and driving conditions, Forward Collision-Avoidance Assist may warn the driver late or may not warn the driver.
- During Forward Collision-Avoidance Assist operation, the vehicle may stop suddenly injuring passengers and shifting loose objects. Always have the seat belt

on and keep loose objects secured.

- If any other function's warning message is displayed or audible warning is generated, Forward Collision-Avoidance Assist warning message may not be displayed and audible warning may not be generated.
- You may not hear the warning sound of Forward Collision-Avoidance Assist if the surrounding is noisy.
- Forward Collision-Avoidance Assist may turn off or may not operate properly or may operate unnecessarily depending on the road conditions and the surroundings.

WARNING

- Even if there is a problem with Forward Collision-Avoidance Assist, the vehicle's basic braking performance will operate normally.
- During emergency braking, braking control by the function will automatically cancel when the driver excessively depresses the accelerator pedal or sharply steers the vehicle.

⚠ CAUTION

- Depending on the condition of the vehicle, pedestrian and cyclist in front and the surroundings, the speed range to operate Forward Collision-Avoidance Assist may reduce. The function may only warn the driver, or the function may not operate.
- Forward Collision-Avoidance Assist will operate under certain conditions by judging the risk level based on the condition of the oncoming vehicle, driving direction, speed and surroundings.

*** NOTICE**

In a situation collision is imminent, braking may be assisted by Forward Collision-Avoidance Assist when braking is insufficient by the driver.

Forward Collision-Avoidance Assist Malfunction and Limitations

Forward Collision-Avoidance Assist malfunction



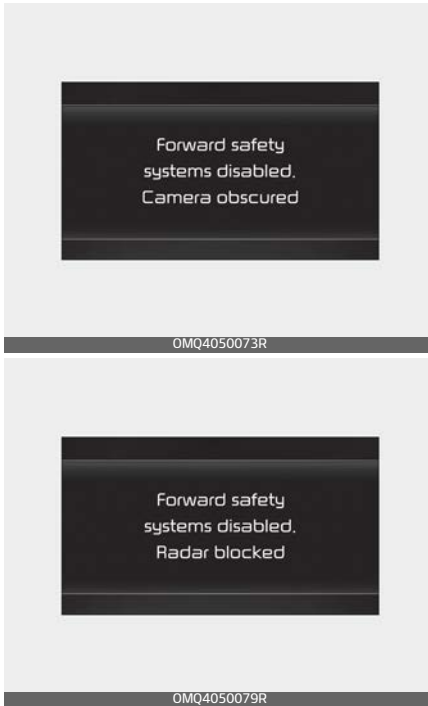

When Forward Collision-Avoidance Assist is not working properly, the 'Check Forward Safety system' warning message will appear, and the (⚠) and (🚗💥➡) warning lights will illuminate on the cluster. Have the function be inspected by an authorised Kia dealer/service partner.

Forward Collision-Avoidance Assist disabled

When the front windscreen where the front view camera is located, front radar cover, sensor is covered with foreign material, such as snow or rain, it can reduce the detecting performance and temporarily limit or disable Forward Collision-Avoidance Assist.

If this occurs the 'Forward Safety Function disabled. Camera obscured' or the 'Forward Safety Function disabled. Radar blocked' warning mes-

sage, and the  and 

warning lights will illuminate on the cluster.

The function will operate normally when snow, rain or foreign matter is removed. Always keep it clean.

If the function does not operate normally after obstruction (snow, rain, or foreign material) is removed, have the function be inspected by an authorised Kia dealer/service partner.

⚠ WARNING

- Even though the warning message or warning light does not appear on the cluster, Forward Collision-Avoidance Assist may not properly operate.
- Forward Collision-Avoidance Assist may not properly operate in an area (e.g. open terrain), where any substance are not detected after turning ON the engine.

Limitations

Forward Collision-Avoidance Assist may not operate normally, or the function may operate unexpectedly under the following circumstances:

- The detecting sensor or the surroundings are contaminated or damaged
- The temperature around the front view camera is high or low

Driving your vehicle

- The camera lens is contaminated due to tinted, filmed or coated windscreen, damaged glass, or stuck of foreign material (sticker, bug, etc.) on the glass
- Moisture is not removed or frozen on the windscreen
- Washer fluid is continuously sprayed, or the wiper is on
- Driving in heavy rain or snow, or thick fog
- The field of view of the front view camera is obstructed by sun glare
- Street light or light from an oncoming vehicle is reflected on the wet road surface, such as a puddle on the road
- An object is placed on the dashboard
- Your vehicle is being towed
- The surrounding is very bright
- The surrounding is very dark, such as in a tunnel, etc.
- The brightness changes suddenly, for example when entering or exiting a tunnel
- The brightness outside is low, and the headlamps are not on or are not bright
- Driving through steam, smoke or shadow
- Only part of the vehicle, pedestrian or cyclist is detected
- The vehicle in front is a bus, heavy truck, truck with a unusually shaped luggage, trailer, etc.

Forward Collision-Avoidance Assist (FCA) (Sensor fusion)

- The vehicle in front has no taillamps, taillamps are located unusually, etc.
- The brightness outside is low, and the taillamps are not on or are not bright
- The rear of the front vehicle is small or the vehicle does not look normal, such as when the vehicle is tilted, overturned, or the side of the vehicle is visible, etc.
- The front vehicle's ground clearance is low or high
- A vehicle, pedestrian or cyclist suddenly cuts in front
- The bumper around the front radar is impacted, damaged or the front radar is out of position
- The temperature around the front radar is high or low
- Driving through a tunnel or iron bridge
- Driving in large areas where there are few vehicles or structures (i.e. desert, meadow, suburb, etc.)
- Driving near areas containing metal substances, such as a construction zone, railroad, etc.
- A material is near that reflects very well on the front radar, such as a guardrail, nearby vehicle, etc.
- The cyclist in front is on a bicycle made of material that does not reflect on the front radar
- The vehicle in front is detected late
- The vehicle in front is suddenly blocked by a obstacle

- The vehicle in front suddenly changes lane or suddenly reduces speed
- The vehicle in front is bent out of shape
- The front vehicle's speed is fast or slow
- The vehicle in front steers in the opposite direction of your vehicle to avoid a collision
- With a vehicle in front, your vehicle changes lane at low speed
- The vehicle in front is covered with snow
- You are departing or returning to the lane
- Unstable driving
- You are on a roundabout and the vehicle in front is not detected
- You are continuously driving in a circle
- The vehicle in front has an unusual shape
- The vehicle in front is driving uphill or downhill.
- The pedestrian or cyclist is not fully detected, for example, if the pedestrian is leaning over or is not fully walking upright
- The pedestrian or cyclist is wearing clothing or equipment that makes it difficult to detect as a pedestrian or cyclist

Following image shows the image the sensor recognises as vehicle, pedestrian, and cyclist.



- The pedestrian or cyclist in front is moving very quickly
- The pedestrian or cyclist in front is short or is posing a low posture
- The pedestrian or cyclist in front has impaired mobility
- The pedestrian or cyclist in front is moving intersected with the driving direction
- There is a group of pedestrians, cyclists or a large crowd in front
- The pedestrian or cyclist is wearing clothing that easily blends into the background, making it difficult to detect
- The pedestrian or cyclist is difficult to distinguish from the similar shaped structure in the surroundings
- You are driving by a pedestrian, cyclist, traffic signs, structures, etc. near the intersection
- Driving in a parking lot
- Driving through a tollgate, construction area, unpaved road, par-

Driving your vehicle

tial paved road, uneven road, speed bumps, etc.

- Driving on an incline road, curved road, etc.
- Driving through a roadside with trees or streetlights
- Unstable driving
- The adverse road conditions cause excessive vehicle vibrations whilst driving
- Your vehicle height is low or high due to heavy loads, abnormal tyre pressure, etc.
- Driving through a narrow road where trees or grass or over-grown
- There is interference by electromagnetic waves, such as driving in an area with strong radio waves or electrical noise

WARNING

- Driving on a curve

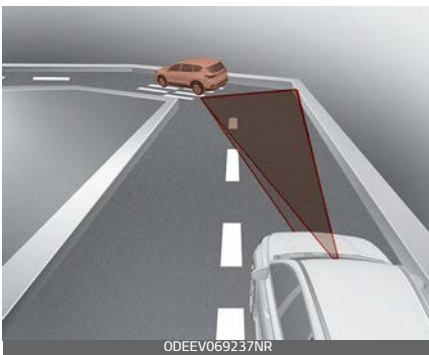

Forward Collision-Avoidance Assist (FCA) (Sensor fusion)

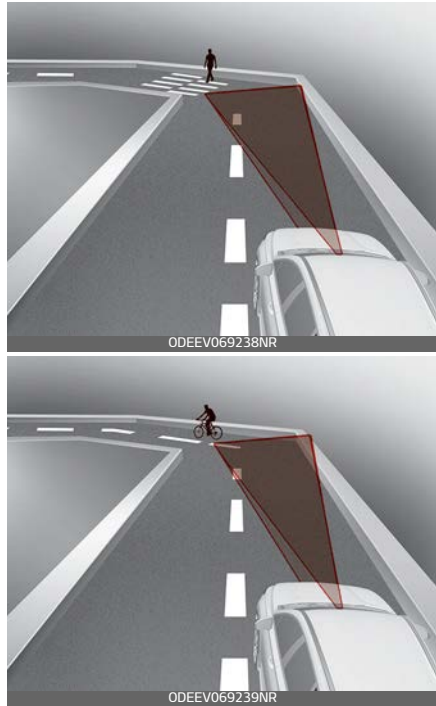

Forward Collision-Avoidance Assist may not detect other vehicle, pedestrian or cyclist in front of you on curved roads adversely affecting the performance of the sensors. This may result in no warning, and braking assist when necessary.

When driving on a curve, you must maintain a safe braking distance, and if necessary, steer the vehicle and depress the brake pedal to reduce your driving speed in order to maintain a safe distance.

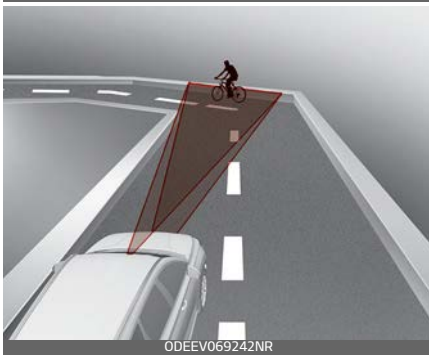
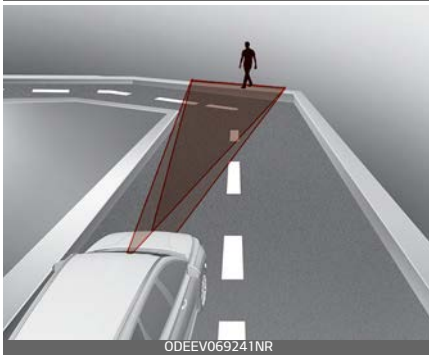
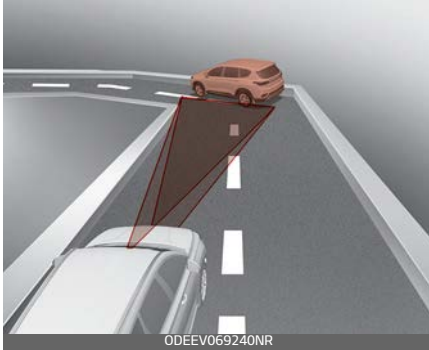

Forward Collision-Avoidance Assist may detect a vehicle, pedestrian or cyclist in the next lane or outside the lane when driving on a curved road. If this occurs, the function may unnecessarily warn the driver and

control the brake. Always check the traffic conditions around the vehicle.

- Driving on a slope



Forward Collision-Avoidance Assist may not detect other vehi-

cles, pedestrians or cyclists in front of you whilst driving uphill or downhill adversely affecting the performance of the sensors. This may result in unnecessary warning, braking assist or no warning, braking assist when necessary.

Also, vehicle speed may rapidly decrease when a vehicle, pedestrian or cyclist ahead is suddenly detected.

Always have your eyes on the road whilst driving uphill or downhill and if necessary, steer your vehicle and depress the brake pedal to reduce your driving speed in order to maintain a safe distance.

- Changing lanes

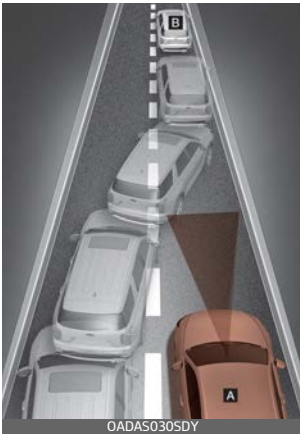

[A]: Your vehicle
[B]: Lane changing vehicle
When a vehicle [B] moves into your lane from an adjacent lane, it cannot be detected by the sensor

until it is in the sensor's detection range. Forward Collision-Avoidance Assist may not immediately detect the vehicle when the vehicle changes lanes abruptly. In this case, you must maintain a safe braking distance, and if necessary, steer your vehicle and depress the brake pedal to reduce your driving speed in order to maintain a safe distance.



[A]: Your vehicle
[B]: Lane changing vehicle
[C]: Same lane vehicle
When a vehicle [B] in front of you merges out of the lane, Forward Collision-Avoidance Assist may not immediately detect the vehicle [C] that is now in front of you. In this case, you must maintain a safe braking distance, and if necessary, steer your vehicle and depress the brake pedal to reduce your driving speed in order to maintain a safe distance.

- Detecting vehicle

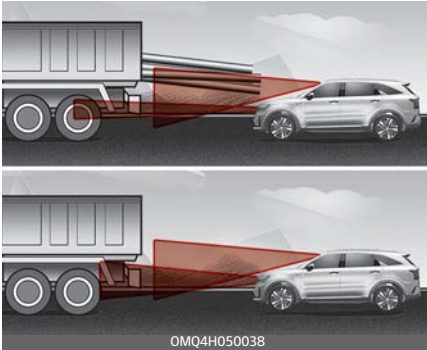

If the vehicle in front of you has cargo that extends rearward from the cab, or when the vehicle in front of you has higher ground clearance, additional special attention is required. Forward Collision-Avoidance Assist may not be able to detect the cargo extending from the vehicle. In these instances, you must maintain a safe braking distance from the rearmost object, and if necessary, steer your vehicle and depress the brake pedal to reduce your driving speed in order to maintain distance.

⚠ WARNING

- When you are towing a trailer or another vehicle, we recommend that Forward Collision-Avoidance Assist is turned off due to safety reasons.
- Forward Collision-Avoidance Assist may operate if objects that are similar in shape or characteristics to vehicles, pedestrians and cyclists are detected.
- Forward Collision-Avoidance Assist does not operate on bicycles, motorcycles, or smaller wheeled objects, such as luggage bags, shopping carts, or strollers that are dragged by a pedestrian or a cyclist.
- Forward Collision-Avoidance Assist may not operate normally if interfered by strong electromagnetic waves.
- Forward Collision-Avoidance Assist may not operate for approximately 15 seconds after the vehicle is started, or the front view camera is initialised.

Lane Keeping Assist (LKA) (if equipped)

Lane Keeping Assist is designed to help detect lane markings (or road edges) whilst driving over a certain speed. The function will warn the driver if the vehicle leaves the lane without using the turn signal, or will automatically assist the driver's steering to help prevent the vehicle from departing the lane.

Detecting sensor

Front view camera



The front view camera is used as a detecting sensor to detect lane markings (or road edges).

Refer to the picture above for the detailed location of the detecting sensor.

⚠ CAUTION

For more details on the precautions of the front view camera, refer to "Forward Collision-Avoidance Assist (FCA) (Sensor fusion) (if equipped)" on page 6-78.

Lane Keeping Assist Settings

Setting

Lane Safety



With the ENGINE START/STOP button in the ON position, select or deselect 'Driver Assistance → Lane Safety' from the Settings menu to set whether or not to use each function.

- If 'Lane Keeping Assist' is selected, the function will automatically assist the driver's steering when lane departure is detected to help prevent the vehicle from moving out of its lane.

- If 'Lane Departure Warning' is selected, the function will warn the driver with an audible warning and steering wheel vibration when lane departure is detected. The driver must steer the vehicle.
- If 'Off' is selected, the function will turn off. The (🚗) indicator light will turn off on the cluster.

⚠ WARNING

- If 'Lane Departure Warning' is selected, steering is not assisted.
- Lane Keeping Assist does not control the steering wheel when the vehicle is driven in the middle of the lane.
- The driver should always be aware of the surroundings and steer the vehicle if 'Off' is selected.

Turning On/Off(Lane Driving Assist button)

[For Europe/Australia]

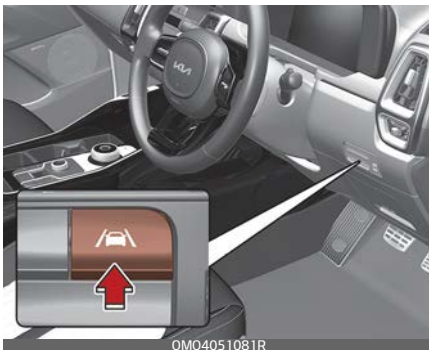

With the ENGINE START/STOP button in the ON position, press the Lane Safety button located on the instrument panel to turn on Lane Keeping Assist. The white (🚗) indicator light will illuminate on the cluster.

*** NOTICE**

- If the engine is restarted, Lane Keeping Assist will maintain the last setting.
- When Lane Keeping Assist is turned off with the Lane Safety button, Lane Safety settings will turn off.

Turning On/Off (Lane Driving Assist button)

[Except Europe/Australia]



With the ENGINE START/STOP button in the ON position, press the Lane Safety button located on the instrument panel to turn on Lane Keeping Assist. The white (🚗) indicator light will illuminate on the cluster.

indicator light will illuminate on the cluster.

*** NOTICE**

- When Lane Keeping Assist is turned off with the Lane Safety button, Lane Safety settings will turn off.

Warning volume



With the ENGINE START/STOP button in the ON position, select 'Driver Assistance → Warning Volume' from the Settings menu to change the Warning Volume to 'High', 'Medium', 'Low' or 'Off' for Lane Keeping Assist.

However, even if 'Off' is selected, the function's Warning Volume will not turn off but the volume will sound as 'Low'.

If you change the Warning Volume, the Warning Volume of other Driver Assistance functions may be changed.

Function operation

Function warning and control

Lane Keeping Assist will warn and control the vehicle with Lane Departure Warning and Lane Keeping Assist.

Lane Departure Warning

Left



Right



- To warn the driver that the vehicle is departing from the projected lane in front, the green () indicator light will blink on the cluster, the lane line will blink on the cluster depending on which direction the vehicle is veering, and an audible warning will sound. Also, the steering wheel will vibrate.
- The function will operate when your vehicle speed is between approximately 60 ~ 200 km/h (40 ~ 120 mph).

Lane Keeping Assist

- To warn the driver that the vehicle is departing from the projected lane in front, the green () indicator light will blink on the cluster, and the steering wheel will make adjustments to keep vehicle inside the lane.
- The function will operate when your vehicle speed is between approximately 60 ~ 200 km/h (40 ~ 120 mph).

Hands-off warning



If the driver takes their hands off the steering wheel for several seconds, the 'Keep hands on the steering wheel' warning message will appear on the cluster, and an audible warning will sound in stages.

⚠ WARNING

- The steering wheel may not be assisted if the steering wheel is held very tight or the steering wheel is steered over a certain degree.
- Lane Keeping Assist does not operate at all times. It is the responsibility of the driver to safely steer the vehicle and to maintain the vehicle in its lane.
- The hands-off warning message may appear late depending on road conditions. Always have your hands on the steering wheel whilst driving.
- If the steering wheel is held very lightly, the hands-off warning

message may appear because the function may not recognise that the driver has their hands on the steering wheel.

- If you attach objects to the steering wheel, the hands-off warning may not work properly.

*** NOTICE**

- For more details on the setting cluster, refer to "Instrument cluster" on page 5-71.
- When lane markings (or road edges) are detected, the lane lines on the cluster will change from grey to white and the green (🚗) indicator light will illuminate.

Lane undetected



Lane detected



- Even though the steering is assisted by Lane Keeping Assist, the driver may control the steering wheel.
- The steering wheel may feel heavier or lighter when the steering wheel is assisted by Lane Keeping Assist than when it is not.

Lane Keeping Assist Malfunction and Limitations

Lane Keeping Assist malfunction



When Lane Keeping Assist is not working properly, the 'Check Lane Keeping Assist (LKA) system' warning message will appear and the yellow () indicator light will illuminate on the cluster. If this occurs, have the function be inspected by an authorised Kia dealer/service partner.

Limitations

Lane Keeping Assist may not operate normally or may operate unexpectedly under the following circumstances:

- The lane is contaminated or difficult to distinguish because,
 - The lane markings (or road edge) is covered with rain, snow, dirt, oil, etc.
 - The colour of the lane marking (or road edge) is not distinguishable from the road
 - There are markings (or road edges) on the road near the lane or the markings (or road edges) on the road looks similar to the lane markings (or road edges)
 - The lane marking (or road edge) is indistinct or damaged
 - The shadow is on the lane marking (or road edge) by a median strip, trees, guardrail, noise barriers, etc.
- There are more than two lane markings (or road edges) on the road
- The lane number increases or decreases, or the lane markings are crossing
- The lane markings (or road edges) are complicated or a structure substitutes for the lines, such as a construction area
- There are road markings, such as zigzag lanes, crosswalk markings and road signs
- The lane suddenly disappears, such as at the intersection
- The lane (or road width) is very wide or narrow
- There is a road edge without a lane
- There is a boundary structure in the roadway, such as a tollgate, sidewalk, kerb, etc.
- The distance to the front vehicle is extremely short or the vehicle in front is covering the lane marking (or road edge)
- The vehicle is driving to the bus lane, or driving at the left or right side of the bus lane

⚠ CAUTION

For more details on the limitations of the front view camera, refer to "Forward Collision-Avoidance Assist (FCA) (Sensor fusion) (if equipped)" on page 6-78.

* NOTICE

Take the following precautions when using Lane Keeping Assist:

- The driver should hold the responsibility to safely drive and control the vehicle. Do not solely rely on the function and drive dangerously.
 - The operation of Lane Keeping Assist can be cancelled or not work properly depending on road conditions and surroundings. Always be cautious whilst driving.
 - Refer to "Limitations" if the lane is not detected properly.
 - When you are towing a trailer or another vehicle, we recommend that Lane Keeping Assist is turned off due to safety reasons.
 - If the vehicle is driven at high speed, the steering wheel will not be controlled. The driver must always follow the speed limit when using the function.
 - If any other function's warning message is displayed or audible warning is generated, Lane Keeping Assist warning message may not be displayed and audible warning may not be generated.
 - You may not hear the warning sound of Lane Keeping Assist if the surrounding is noisy.
 - If you attach objects to the steering wheel, steering may not be assisted properly.
- Lane Keeping Assist may not operate for approximately 15 seconds after the vehicle is started, or the Front view camera is initialised.
 - Lane Keeping Assist will not operate when:
 - The turn signal or hazard warning flasher is turned on
 - The vehicle is not driven in the centre of the lane when the function is turned on or right after changing a lane
 - ESC (Electronic Stability Control) or VSM (Vehicle Stability Management) is activated
 - The vehicle is driven on a sharp curve
 - Vehicle speed is below 55 km/h (34 mph) or above 210 km/h (130 mph)
 - The vehicle makes sharp lane changes
 - The vehicle brakes suddenly
-

Blind-Spot Collision-Avoidance Assist (BCA) (if equipped)

Blind-Spot Collision-Avoidance Assist is designed to help detect and monitor approaching vehicles in the driver's blind spot area and warn the driver of a possible collision with a warning message and audible warning.

In addition, if there is a risk of collision when changing lanes or driving forward out of a parking space, the function will help avoid collision by applying the differential braking.

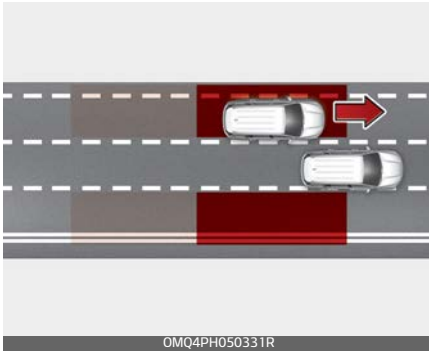

Blind-Spot Collision-Avoidance Assist will help detect and inform the driver that a vehicle is in the blind spot.

CAUTION

The detecting range may vary depending on the speed of your vehicle. However, even if there is a vehicle in the blind spot, the function

may not warn you when you pass by at high speeds.

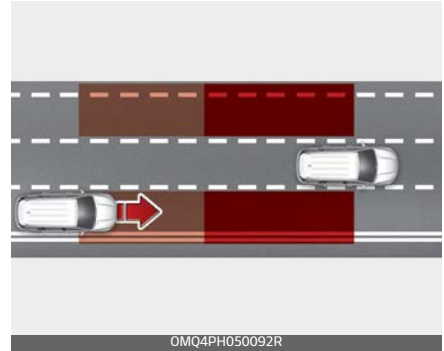

Blind-Spot Collision Assist help detect and informs the driver that a vehicle is approaching at high speed from the blind spot area.

CAUTION

Warning timing may vary depending on the speed of the vehicle approaching at high speed.

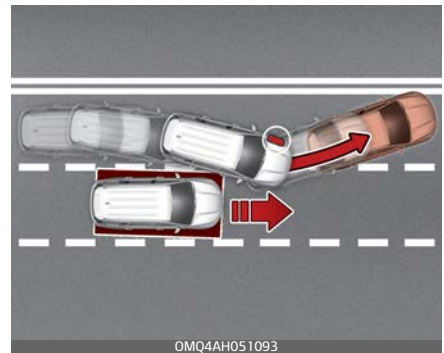

When changing lanes by detecting the lane ahead, if the function judges that there is a collision risk

with an approaching vehicle in the blind spot, the function will help avoid collision by applying the differential braking.

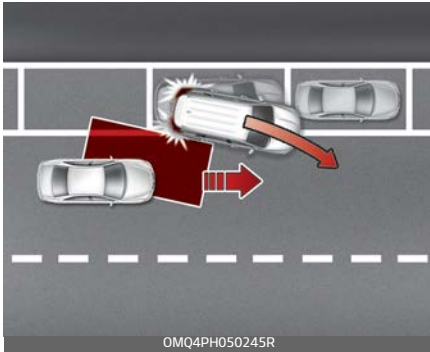

When you are driving forward out of a parking space, if the function judges that there is a collision risk with an approaching vehicle in the blind spot, the function will help avoid collision by applying the differential braking.

*** NOTICE**

- In the following text, Blind-Spot Collision-Avoidance Assist will be referred as Blind-Spot Safety system.

Detecting sensor

Front view camera



Rear corner radar



Refer to the picture above for the detailed location of the detecting sensors.

⚠ CAUTION

Take the following precautions to maintain optimal performance of the detecting sensor:

- Never disassemble the rear corner radar or radar assembly, or apply any impact on it.
- If there is impact on the rear corner radar or near the radar, even

though the warning message does not appear on the cluster, Blind-Spot Safety system may not operate properly. Have the function be inspected by an authorised Kia dealer/service partner.

- If the rear corner radars have been replaced or repaired, Have the vehicle be inspected by an authorised Kia dealer/service partner.
- Use only genuine Kia parts to repair the rear bumper where the rear corner radar is located.
- Do not apply license plate frame or objects, such as a bumper sticker, film or a bumper guard near the rear corner radar.
- The function may not work properly if the bumper has been replaced, or the surroundings of the rear corner radar has been damaged or paint has been applied.
- If a trailer, carrier, etc. is installed, it may adversely affect the performance of the rear corner radar or the function may not operate.

⚠ CAUTION

For more details on the precautions of the front view camera, refer to "Forward Collision-Avoidance Assist (FCA) (Sensor fusion) (if equipped)" on page 6-78.

Blind-Spot Collision-Avoidance Assist Settings

Setting

Blind-Spot Safety



With the ENGINE START/STOP button in the ON position, select or deselect 'Driver Assistance → Blind-Spot Safety' from the Settings menu to set whether or not to use each function.

- If 'Active Assist' is selected, the function will warn the driver with a warning message, an audible warning, steering wheel vibration and braking assist will be applied depending on the collision risk levels.
- If 'Warning Only' is selected, the function will warn the driver with a warning message, an audible warning and steering wheel vibration depending on the collision risk levels. Braking will not be assisted.
- If 'Off' is selected, the function will turn off.



When the engine is restarted with the function off, the 'Blind-Spot Safety System is Off' message will appear on the cluster.

If you change the setting from 'Off' to 'Active Assist' or 'Warning Only', the warning light on the side view mirror will blink for approximately 3 seconds.

In addition, if the engine is turned on, when the function is set to 'Active Assist' or 'Warning Only', the warning light on the side view mirror will blink for approximately 3 seconds.

⚠ WARNING

- If 'Warning Only' is selected, braking is not assisted.
- If 'Off' is selected, the driver should always be aware of the surroundings and drive safely.

*** NOTICE**

If the engine is restarted, Blind-Spot Safety system will maintain the last setting.

Warning timing



With the ENGINE START/STOP button in the ON position, select 'Driver Assistance → Warning Timing' from the Settings menu to change the initial warning activation time for Blind-Spot Safety system.

When the vehicle is first delivered, Warning Timing is set to 'Normal'. If you change the Warning Timing, the warning time of other Driver Assistance systems may change.

Warning volume



OMQ4041606

With the ENGINE START/STOP button in the ON position, select 'Driver Assistance → Warning Volume' from the Settings menu to change the Warning Volume to 'High', 'Medium', 'Low' or 'Off' for Blind-Spot Safety system.

However, when Warning Volume is turned off, the steering wheel vibration function will turn on if it was turned off.

If you change the Warning Volume, the warning volume of other Driver Assistance systems may change.

CAUTION

- The setting of the Warning Timing and Warning Volume applies to all functions of the Blind-Spot Safety system.
- Even though 'Normal' is selected for Warning Timing, if the vehicle approaches at high speed, the initial warning activation time may seem late.

- Select 'Late' for Warning Timing when traffic is light and when driving speed is slow.

Blind-Spot Collision-Avoidance Assist Operation

Warning and control

Vehicle detection



OMQ4AH051098

- To warn the driver a vehicle is detected, the warning light on the side view mirror and head-up display (if equipped) will illuminate.
- The function will operate when your vehicle speed is above 20 km/h (12 mph) and the speed of the vehicle in the blind spot area is above 10 km/h (7 mph).

Collision warning

- Collision warning will operate when the turn signal is turned on in the direction of the detected vehicle.

- If 'Warning Only' is selected from the Settings menu, the collision warning will operate when your vehicle approaches the lane the blind spot vehicle is detected.
- To warn the driver of a collision, the warning light on the side view mirror and head-up display (if equipped) will blink. At the same time, an audible warning will sound and the steering wheel will vibrate.
- When the turn signal is turned off, the collision warning will be cancelled and the function will return to vehicle detection state.

*** NOTICE**

- The detecting range of the rear corner radar is determined by a standard road width, therefore, on a narrow road, the function may detect other vehicles in the next lane and warn you. In contrast, on a wide road, the function may not be able to detect a vehicle driving in the next lane and may not warn you.
- When the hazard warning flasher is on, the collision warning by the turn signal will not operate.

*** NOTICE**

If the driver's seat is on the left side, the collision warning may occur when you turn left. Maintain a

proper distance with the vehicles in the left lane. If the driver's seat is on the right side, the collision warning may occur when you turn right. Maintain a proper distance with the vehicles in the right lane.

Collision-Avoidance Assist (whilst driving)



- To warn the driver of a collision, the warning light on the side view mirror will blink and a warning message will appear on the cluster. At the same time, an audible warning will sound, warning light on the head-up display (if equipped) will blink and the steering wheel will vibrate.
- The function will operate when your vehicle speed is between 60 ~ 200 km/h (40 ~ 120 mph) and both lane markings of the driving lane are detected.
- Emergency braking will be assisted to help prevent collision

with the vehicle in the blind spot area.

*** NOTICE**

- Collision-Avoidance Assist will be cancelled under the following circumstances:
 - Your vehicle enters the next lane by a certain distance
 - Your vehicle is away from the collision risk
 - The steering wheel is sharply steered
 - The brake pedal is depressed
 - Forward Collision-Avoidance Assist is operating
- After Function Operation or changing lane, you must drive to the centre of the lane. The function will not operate if the vehicle is not driven in the centre of the lane.

- To warn the driver of a collision, the warning light on the side view mirror will blink and a warning message will appear on the cluster. At the same time, an audible warning will sound, warning light on the head-up display (if equipped) will blink and the steering wheel will vibrate.
- The function will operate when your vehicle speed is below 3 km/h (2 mph) and the speed of the vehicle in the blind spot area is above 5 km/h (3 mph).
- Emergency braking will be assisted to help prevent collision with the vehicle in the blind spot area.

Stopping vehicle and ending brake control

Collision-Avoidance Assist (whilst departing)



- When the vehicle is stopped due to emergency braking, the 'Drive carefully' warning message will appear on the cluster.

- For your safety, the driver should depress the brake pedal immediately and check the surroundings.
- Brake control will end after the vehicle is stopped by emergency braking for approximately 2 seconds.

⚠ WARNING

Take the following precautions when using Blind-Spot Safety System:

- For your safety, change the Settings after parking the vehicle at a safe location.
- If any other function's warning message is displayed or audible warning is generated, Blind-Spot Safety system's warning message may not be displayed and audible warning may not be generated.
- You may not hear the warning sound of Blind-Spot Safety system if the surrounding is noisy.
- Blind-Spot Safety system may not operate if the driver applies the brake pedal to avoid collision.
- When Blind-Spot Safety system is operating, braking control by the function will automatically cancel when the driver excessively depresses the accelerator pedal or sharply steers the vehicle.
- During Blind-Spot Safety system operation, the vehicle may stop suddenly injuring passengers and

shifting loose objects. Always have the seat belt on and keep loose objects secured.

- Even if there is a problem with Blind-Spot Safety system, the vehicle's basic braking performance will operate normally.
- Blind-Spot Safety system does not operate in all situations or cannot avoid all collisions.
- Blind-Spot Safety system may warn the driver late or may not warn the driver depending on the road and driving conditions.
- Driver should maintain control of the vehicle at all times. Do not depend on Blind-Spot Safety system. Maintain a safe braking distance, and if necessary, depress the brake pedal to reduce driving speed or to stop the vehicle.
- Never operate Blind-Spot Safety system on people, animal, objects, etc. It may cause serious injury or death.

⚠ WARNING

- The brake control may not operate properly depending on the status of ESC (Electronic Stability Control).
- There will only be a warning when:
 - The ESC (Electronic Stability Control) warning light is on

- ESC (Electronic Stability Control) is engaged in a different function

Blind-Spot Collision-Avoidance Assist Malfunction and Limitations

Blind-Spot Collision-Avoidance Assist malfunction



OMQ4050229R

When Blind-Spot Safety system is not working properly, the 'Check Blind-Spot Safety systems' warning message will appear on the cluster, and the function will turn off automatically or the function will be limited. Have the function be inspected by an authorised Kia dealer.



OMQ4050291R

When the side view mirror warning light is not working properly, the 'Check outside mirror warning light' warning message will appear on the cluster. Have the function be inspected by an authorised Kia dealer.

Blind-Spot Collision-Avoidance Assist disabled



OMQ4050230L

When the rear bumper around the rear corner radar or sensor is covered with foreign material, such as snow or rain, or installing a trailer or carrier, it can reduce the detecting performance and temporarily limit

or disable Blind-Spot Safety system.

If this occurs, the 'Blind-Spot Safety system disabled. Radar blocked' warning message will appear on the cluster.

The function will operate normally when such foreign material or trailer, etc. is removed, and then the engine is restarted.

If the function does not operate normally after it is removed, have the function be inspected by an authorised Kia dealer.

⚠ WARNING

- Even though the warning message does not appear on the cluster, Blind-Spot Safety system may not properly operate.
- Blind-Spot Safety system may not properly operate in an area (e.g. open terrain) where any substance are not detected right after the engine is turned on, or when the detecting sensor is blocked with foreign material right after the engine is turned on.

⚠ CAUTION

Turn off Blind-Spot Safety system to install a trailer, carrier, etc., or

remove the trailer, carrier, etc. to use Blind-Spot Safety system.

Limitations

Blind-Spot Safety system may not operate normally, or the function may operate unexpectedly under the following circumstances:

- There is inclement weather, such as heavy snow, heavy rain, etc.
- The rear corner radar is covered with snow, rain, dirt, etc.
- The temperature around the rear corner radar is high or low
- Driving on a highway (or motorway) ramp
- The road pavement (or the peripheral ground) abnormally contains metallic components (i.e. possibly due to subway construction).
- There is a fixed object near the vehicle, such as sound barriers, guardrails, central dividers, entry barriers, street lamps, signs, tunnels, walls, etc. (including double structures)
- Driving in large areas where there are few vehicles or structures (i.e. desert, meadow, suburb, etc.)
- Driving through a narrow road where trees or grass are overgrown
- Driving in large areas where there are few vehicles or structures (i.e. desert, meadow, suburb, etc.)

- Driving on a wet road surface, such as a puddle on the road
- The other vehicle drives very close behind your vehicle, or the other vehicle passes by your vehicle in close proximity
- The speed of the other vehicle is very fast that it passes by your vehicle in a short time
- Your vehicle passes by the other vehicle
- Your vehicle changes lane
- Your vehicle has started at the same time as the vehicle next to you and has accelerated
- The vehicle in the next lane moves two lanes away from you, or when the vehicle two lanes away moves to the next lane from you
- A trailer or carrier is installed around the rear corner radar
- The bumper around the rear corner radar is covered with objects, such as a bumper sticker, bumper guard, bike rack, etc.
- The bumper around the rear corner radar is impacted, damaged or the radar is out of position
- Your vehicle height is low or high due to heavy loads, abnormal tyre pressure, etc.

Blind-Spot Safety system may not operate normally, or the function may operate unexpectedly when the following objects are detected:

- A motorcycle or bicycle is detected

- A vehicle such as a flat trailer is detected
- A big vehicle such as a bus or truck is detected
- A moving obstacle such as a pedestrian, animal, shopping cart or a baby stroller is detected
- A vehicle with low height such as a sports car is detected

Braking control may not work, driver's attention is required in the following circumstances:

- The vehicle severely vibrates whilst driving over a bumpy road, uneven road or concrete patch
- Driving on a slippery surface due to snow, water puddle, ice, etc.
- The tyre pressure is low or a tyre is damaged
- The brake is reworked
- The vehicle makes abrupt lane changes

CAUTION

For more details on the limitations of the front view camera, refer to "Forward Collision-Avoidance Assist (FCA) (Front view camera only) (if equipped)" on page 6-65.

⚠ WARNING

- Driving on a curve



Blind-Spot Safety system may not operate properly when driving on a curved road. The function may not detect the vehicle in the next lane. Always pay attention to road and driving conditions whilst driving.



Blind-Spot Safety system may not operate properly when driving on a curved road. The function may recognise a vehicle in the same lane. Always pay attention to road and driving conditions whilst driving.

- Driving where the road is merging/dividing

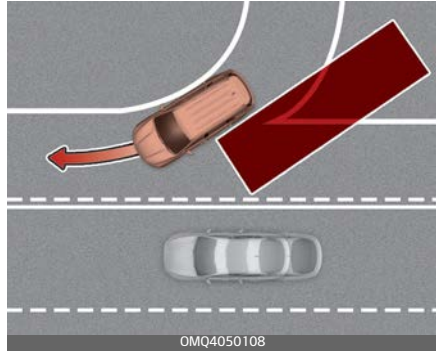

Blind-Spot Safety system may not operate properly when driving where the road merges or divides. The function may not detect the vehicle in the next lane. Always pay attention to road and driving conditions whilst driving.

- Driving on a slope

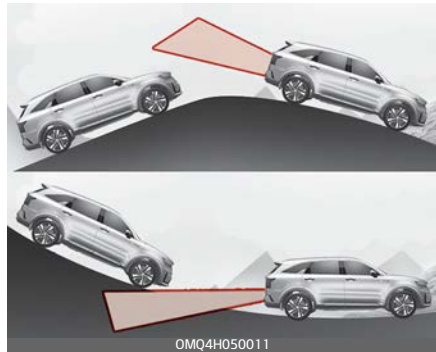

Blind-Spot Safety system may not operate properly when driving on a slope. The function may not detect the vehicle in the next lane or may incorrectly detect the ground or structure.

Always pay attention to road and driving conditions whilst driving.

- Driving where the heights of the lanes are different

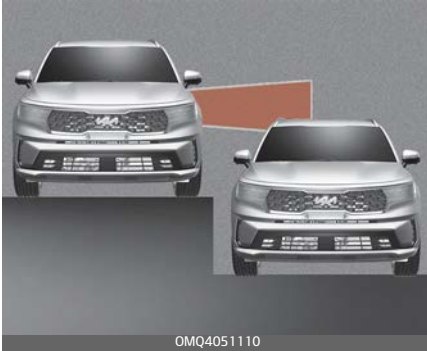

Blind-Spot Safety system may not operate properly when driving where the heights of the lanes are different. The function may not detect the vehicle on a road with different lane heights (underpass joining section, grade separated intersections, etc.). Always pay attention to road and driving conditions whilst driving.

seconds after the vehicle is started, or the front view camera or rear corner radars are initialised.

⚠ WARNING

- When you are towing a trailer or another vehicle, make sure that you turn off Blind-Spot Safety system.
- Blind-Spot Safety system may not operate normally if interfered by strong electromagnetic waves.
- Blind-Spot Safety system may not operate for approximately 15

Safe Exit Warning (SEW) (if equipped)

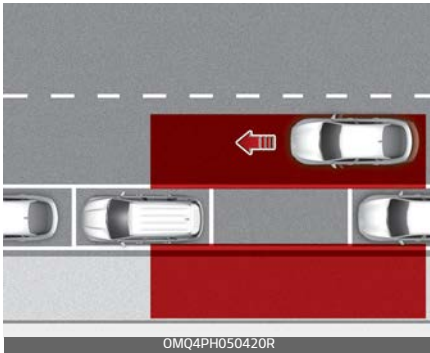

After the vehicle stops, when an approaching vehicle from the rear area is detected as soon as a passenger opens a door, Safe Exit Warning will warn the driver with a warning message and an audible warning to help prevent a collision.

⚠ CAUTION

Warning timing may vary depending on the speed of the approaching vehicle.

Detecting sensor

Rear corner radar



Refer to the picture above for the detailed location of the detecting sensor.

*** NOTICE**

For more details on the precautions of the rear corner radars, refer to "Blind-Spot Collision-Avoidance Assist (BCA) (if equipped)" on page 6-101.

Safe Exit Warning Settings

Setting

Safe Exit Warning



With the ENGINE START/STOP button in the ON position, select 'Driver Assistance → Blind-Spot Safety → Safe Exit Warning' from the Settings menu to turn on Safe Exit Warning and deselect to turn off the function.

⚠ WARNING

The driver should always be aware of unexpected and sudden situations from occurring. If 'Safe Exit Assist' is deselected, the function cannot assist you.

*** NOTICE**

If the engine is restarted, Safe Exit Warning will maintain the last setting.

Warning timing



With the ENGINE START/STOP button in the ON position, select 'Driver Assistance → Warning Timing' from the Settings menu to change the initial warning activation time for Blind-Spot Safety system.

When the vehicle is first delivered, warning timing is set to 'Normal'. If you change the warning timing, the warning time of other Driver Assistance systems may change.

Warning volume



With the ENGINE START/STOP button in the ON position, select 'Driver Assistance → Warning Volume' from the Settings menu to change the warning volume to 'High', 'Medium', 'Low' or 'Off' for Blind-Spot Safety system.

However, when Warning Volume is turned off, the steering wheel vibration function will turn on if it was turned off.

If you change the warning volume, the warning volume of other Driver Assistance systems may change.

⚠ CAUTION

- The setting of the Warning Timing and Warning Volume applies to all functions of the Safe Exit Warning.
- Even though 'Normal' is selected for warning timing, if the vehicle approaches at high speed from the rear, the initial warning activation time may seem late.
- Select 'Late' for warning timing when traffic is light and when driving speed is slow.

* NOTICE

If the engine is restarted, Warning timing and Warning volume will maintain the last setting.

Safe Exit Warning Operation

Warning

Collision warning when exiting vehicle



- When an approaching vehicle from the rear is detected at the moment a door is opened, the 'Watch out for traffic' warning message will appear on the cluster, and an audible warning will sound.
- Safe Exit Warning will warn the driver when your vehicle speed is below 3 km/h (2 mph), and the speed of the approaching vehicle from the rear is above 5 km/h (3 mph).

* NOTICE

Take the following precautions when using Safe Exit Warning :

- For your safety, change the Settings after parking the vehicle at a safe location.
- If any other function's warning message is displayed or audible warning is generated, Safe Exit Warning warning message may not be displayed and audible warning may not be generated.
- You may not hear the warning sound of Safe Exit Warning if the surrounding is noisy.
- Safe Exit Warning does not operate in all situations or cannot prevent all collisions.
- Safe Exit Warning may warn the driver late or may not warn the driver depending on the road and driving conditions. Always check vehicle surroundings.
- The driver and passengers are responsible for accidents that occurs whilst exiting the vehicle. Always check the surroundings before you exit the vehicle.
- Never deliberately operate Safe Exit Warning. Doing so may lead to serious injury or death.

- Safe Exit Warning does not operate if there is a problem with Blind-Spot Safety system. The warning message of Blind-Spot Safety system will appear when :
 - Blind-Spot Safety system sensor or the sensor surrounding is polluted or covered
 - Blind-Spot Safety system fails to warn passengers or falsely warn passengers

* NOTICE

After the engine is turned off, Safe Exit Warning operates approximately for 3 minutes, but turns off immediately if the doors are locked.

Safe Exit Assist (SEA) (if equipped)

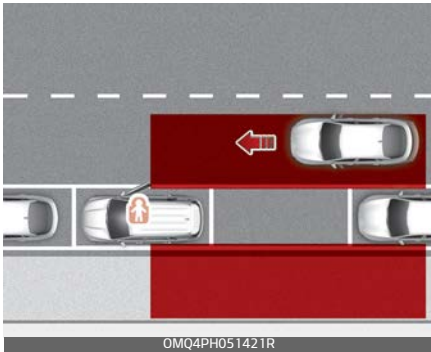

OMQ4PH051421R

After the vehicle stops, when an approaching vehicle from the rear area is detected as soon as a passenger opens a door, Safe Exit Assist will warn the driver with a warning message and an audible warning to help prevent a collision.



OMQ4040008R

In addition, when the electronic child safety lock button is in the LOCK position and an approaching vehicle from the rear area is detected, the electronic child safety lock button will not unlock even if the driver

presses the button to prevent the rear doors from opening.

⚠ CAUTION

Warning timing may vary depending on the speed of the approaching vehicle.

Detecting sensor

Rear corner radar



OMQ4AH051330

Refer to the picture above for the detailed location of the detecting sensor.

* NOTICE

For more details on the precautions of the rear corner radars, refer to "Blind-Spot Collision-Avoidance Assist (BCA) (if equipped)" on page 6-101.

Safe Exit Assist Settings

Setting

Safe Exit Assist



With the ENGINE START/STOP button in the ON position, select 'Driver Assistance → Blind-Spot Safety → Safe Exit Assist' from the Settings menu to turn on Safe Exit Assist and deselect to turn off the function.

⚠ WARNING

The driver should always be aware of unexpected and sudden situations from occurring. If 'Safe Exit Assist' is deselected, the function cannot assist you.

*** NOTICE**

If the engine is restarted, Safe Exit Assist will maintain the last setting.

Warning timing



With the ENGINE START/STOP button in the ON position, select 'Driver Assistance → Warning Timing' from the Settings menu to change the initial warning activation time for Blind-Spot Safety system.

When the vehicle is first delivered, Warning Timing is set to 'Normal'. If you change the Warning Timing, the warning time of other Driver Assistance systems may change.

Warning volume



With the ENGINE START/STOP button in the ON position, select 'Driver Assistance → Warning Volume' from the Settings menu to change the Warning Volume 'High', 'Medium', 'Low' or 'Off' for Blind-Spot Safety system.

However, when Warning Volume is turned off, the steering wheel vibration function will turn on if it was turned off.

If you change the Warning Volume, the Warning Volume of other Driver Assistance systems may change.

⚠ CAUTION

- The setting of the Warning Timing and Warning Volume applies to all functions of Safe Exit Assist.
- Even though 'Normal' is selected for Warning Timing, if the vehicles approaches at high speed from the rear, the initial warning activation time may seem late.
- Select 'Late' for Warning Timing when traffic is light and when driving speed is slow.

Function operation

Warning and control

Collision warning when exiting vehicle



- When an approaching vehicle from the rear is detected at the moment a door is opened, the 'Watch out for traffic' warning message will appear on the cluster, and an audible warning will sound.
- Safe Exit Assist will warn the driver when your vehicle speed is below 2 mph (3 km/h), and the speed of the approaching vehicle from the rear is above 3 mph (5 km/h).

Safe Exit Assist linked with Electronic child safety lock

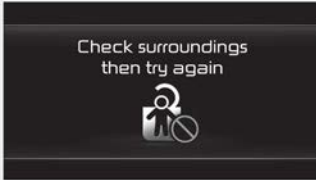

OMQ4040506R

- When Electric child safety lock is operating and an approaching vehicle from the rear area is detected, the rear doors cannot be unlocked even if the driver tries to unlock the rear doors using the electronic child safety lock button. The 'Check surroundings then try again' warning message will appear on the cluster.
- Safe Exit Assist will warn the driver when vehicle speed is below 3 km/h (2 mph) and the speed of the approaching vehicle from the rear is above 5 km/h (3 mph).
- For more details on electric child safety lock button, refer to "Electronic child safety lock system (if equipped)" on page 5-23.

⚠ CAUTION

If the driver presses the electronic child lock button again approximately within 10 seconds after the warning message appears, Safe Exit Assist judges that the driver has unlocked the doors acknowledging the rear status. The electronic child safety lock will turn off (button indicator OFF) and the rear doors will unlock. Always check the surroundings before turning off the electronic child safety lock button.

⚠ WARNING

Take the following precautions when using Safe Exit Assist:

- For your safety, change the Settings after parking the vehicle at a safe location.
- If any other function's warning message is displayed or audible warning is generated, Safe Exit Assist warning message may not be displayed and audible warning may not be generated.
- You may not hear the warning sound of Safe Exit Assist if the surrounding is noisy.
- Safe Exit Assist does not operate in all situations or cannot prevent all collisions.

- Safe Exit Assist may warn the driver late or may not warn the driver depending on the road and driving conditions. Always check vehicle surroundings.
- The driver and passengers are responsible for accidents that occurs whilst exiting the vehicle. Always check the surroundings before you exit the vehicle.
- Never deliberately operate Safe Exit Assist. Doing so may lead to serious injury or death.
- Safe Exit Assist does not operate if there is a problem with Blind-Spot Safety system.
 - The warning message of Blind-Spot Safety system will appears
 - Blind-Spot Safety system sensor or the sensor surrounding is polluted or covered
 - Blind-Spot Safety system fails to warn passengers or falsely warn passengers

*** NOTICE**

After the engine is turned off, Safe Exit Assist operates approximately for 3 minutes, but turns off immediately if the doors are locked.

Safe Exit Assist Malfunction and Limitations

Safe Exit Assist malfunction



OMQ4050229R

When Safe Exit Assist is not working properly, the 'Check Blind-Spot Safety systems' warning message will appear on the cluster, and the function will turn off automatically or the function will be limited. Have the function be inspected by an authorised Kia dealer.

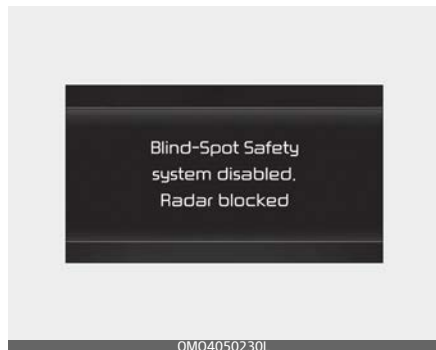

OMQ4050230L

When the rear bumper around the rear corner radar or sensor is covered with foreign matters, such as snow or rain, or installing a trailer or

carrier, it can reduce the detecting performance and temporarily limit or disable Safe Exit Assist.

If this occurs, the 'Blind-Spot Safety system disabled. Radar blocked' warning message will appear on the cluster.

The function will operate normally when such foreign matters or trailer, etc. is removed. Always keep it clean.

If the function does not operate normally after it is removed, have your vehicle inspected by an authorised Kia dealer.

* NOTICE

- Even though the warning message does not appear on the cluster, Safe Exit Assist may not properly operate.
- Safe Exit Assist may not properly operate in an area (e.g., open terrain), where any substance are not detected after turning ON the engine.

⚠ CAUTION

Turn off Safe Exit Assist to install a trailer, carrier, etc., or remove the trailer, carrier, etc. to use Safe Exit Assist.

Limitations

Safe Exit Assist may not operate normally, or the function may operate unexpectedly under the following circumstances:

- Driving through a narrow road where trees or grass or overgrown
- Driving on a wet road surface, such as a puddle in the road
- The speed of the other vehicle is very fast or slow

* NOTICE

For more details on the precautions of the rear corner radars, refer to "Blind-Spot Collision-Avoidance Assist (BCA) (if equipped)" on page 6-101.

⚠ WARNING

- Safe Exit Assist may not operate normally if interfered by strong electromagnetic waves.
- Safe Exit Assist may not operate for approximately 3 seconds after the vehicle is started, or the rear corner radars are initialised.

Manual Speed Limit Assist (MSLA) (if equipped)



- (1) Speed Limit indicator
- (2) Set speed

You can set the speed limit when you do not want to drive over a specific speed.

If you drive over the preset speed limit, the warning function operates (set speed limit will blink and chime will sound) until the vehicle speed returns within the speed limit.

Function operation

Setting speed limit

1. Press and hold Driving Assist (MODE) button at the desired speed.



The speed limit indicator light will illuminate on the cluster.



2. Push the + switch up or - switch down, and release it at the desired speed. Move the + switch up or - switch down and hold it. The speed will increase or decrease to the nearest multiple of five (multiple of ten in km/h) at first, and then increase or decrease by 10 km/h (5 mph).



- The set speed limit will be displayed on the cluster. The set speed limit will blink and chime will sound until you return the vehicle speed within the speed limit.



*** NOTICE**

When the accelerator pedal is not depressed beyond the pressure point, vehicle speed will maintain within the speed limit.

Temporarily pausing the function

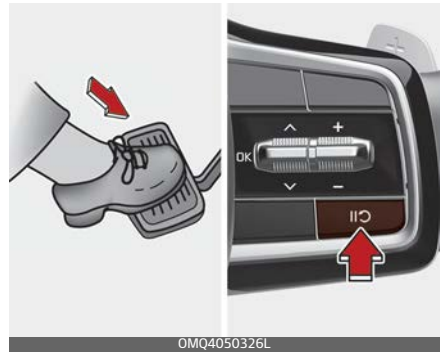

Push the (|| ↻) switch to temporarily pause the set speed limit. The set speed limit will turn off but the Speed Limit indicator will stay on.

Resuming the function



To resume Manual Speed Limit Assist after the function was paused, push the +, -, (|| ↻) switch.

If you push the + switch up or - switch down, vehicle speed will be set to the current speed on the cluster.

If you push the (|| ⌚) switch, vehicle speed will resume to the preset speed.

Turning off the function



Press the Driving Assist (⌚MODE) button to turn Manual Speed Limit Assist off. The Speed Limit indicator will go off.

Always press the Driving Assist (⌚MODE) button to turn Manual Speed Limit Assist off when not in use.

⚠ WARNING

Take the following precautions when using Manual Speed Limit Assist:

- Always set the vehicle speed to the speed limit in your country.
- Keep Manual Speed Limit Assist off when the function is not in use, to avoid inadvertently setting a speed. Check that the Speed Limit indicator is off.
- Manual Speed Limit Assist does not substitute for proper and safe driving. It is the responsibility of the driver to always drive safely and should always be aware of unexpected and sudden situations from occurring. Pay attention to the road conditions at all times.

Intelligent Speed Limit Assist (ISLA) (if equipped)

Intelligent Speed Limit Assist uses information from the detected road sign and navigation system to inform the driver of the speed limit and additional road signs. Also, the function helps the driver to maintain within the speed limit of the road.

* NOTICE

- Intelligent Speed Limit Assist may not operate properly if the function is used in other countries.
- Update your navigation regularly to ensure that Intelligent Speed Limit Assist works properly.

Detecting sensor

Front view camera



Refer to the picture above for the detailed location of the detecting sensor.

⚠ CAUTION

For more precautions related to the camera sensor, refer to "Forward Collision-Avoidance Assist (FCA) (Sensor fusion) (if equipped)" on page 6-78.

Intelligent Speed Limit Assist Settings

Setting

Speed limit

With the ENGINE START/STOP button in the ON position, select or deselect 'Driver Assistance → Intelligent Speed Limit Assist' from the Settings menu to set whether or not to use each function.

- If 'Speed Limit Assist' is selected, the function will inform the driver of speed limit. In addition, the function will inform the driver to change set speed of Manual Speed Limit Assist and/or Smart Cruise Control to help the driver stay within the speed limit.
- If 'Speed Limit Warning' is selected, the function will inform the driver of speed limit. In addition, the function will warn the driver when the vehicle is driven faster than the speed limit.
- If 'Off' is selected, the function will turn off.

⚠ CAUTION

- If 'Speed Limit Warning' is selected, the function will not inform the driver to adjust set speed.
- The speed limit offset setting is not reflected in the Navigation-based Smart Cruise Control.

Speed limit offset

With the ENGINE START/STOP button in the ON position, when 'Driver Assistance → Speed Limit → Speed Limit Offset' is selected, the Speed Limit Offset can be changed. Speed Limit Warning and Speed Limit Assist will operate by applying the Speed Limit Offset setting to the detected speed limit.

⚠ WARNING

- For your safety, change the Settings after parking the vehicle at a safe location.
- Speed Limit Assist function operates based on the Offset setting added to the speed limit. If you want to change the set speed according to the speed limit, set the offset to '0'.
- Speed Limit Warning function warns the driver when driving speed exceeds the speed at which the set Offset is added to speed limit. If you want Speed Limit

Warning to warn you immediately when the driving speed exceeds the speed limit, set the offset to '0'.

Function operation***Function warning and control***

Intelligent Speed Limit Assist will warn and control the vehicle by 'Displaying speed limit', 'Warning over-speed' and 'Changing set speed'.

*** NOTICE**

- Function warning and control are described based on the Offset set to '0'. For details on Offset setting, refer to "Intelligent Speed Limit Assist Settings" on page 6-127.

Displaying speed limit

OMQ4051308L

Driving Assist screen selected (For Europe)

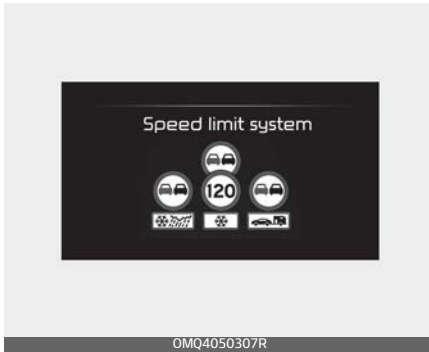

Speed limit information is displayed on the instrument cluster.

*** NOTICE**

- Depending on the instrument panel specifications or theme, images or colours may be displayed differently.

Warning overspeed



When driving at a speed higher than the displayed speed limit, the red speed limit indicator will blink.

Changing set speed



If the speed limit of the road changes during the operation of Manual Speed Limit Assist or Smart Cruise Control, an arrow in the direction of up or down is displayed to inform the driver that the set speed needs to be changed. At this time, the driver can change the set speed according to the speed limit by using the + or - switch on the steering wheel.

⚠ WARNING

- If the Offset is set over '0', the set speed will change to a higher speed than the speed limit of the road. If you want to drive below the speed limit, set the Offset under '0' or use the - switch on the steering wheel to lower the set speed.
- Even after changing the set speed according to the speed limit of the road, the vehicle can still be driven over the speed limit. If necessary, depress the brake pedal to reduce your driving speed.
- If the speed limit of the road is under 30 km/h (20 mph), the set speed change function will not work.
- Intelligent Speed Limit Assist operates using the speed unit in the instrument cluster set by the driver. If the speed unit is set to a unit other than the speed unit used in your country, Intelligent Speed Limit Assist may not operate properly.

*** NOTICE**

- For more details on function operation of Manual Speed Limit Assist, refer to "Manual Speed Limit Assist (MSLA) (if equipped)" on page 6-124.
- For more details on operation of Smart Cruise Control, refer to

"Smart Cruise Control (SCC) (if equipped)" on page 6-146.

Intelligent Speed Limit Assist Malfunction and Limitations

Intelligent Speed Limit Assist malfunction

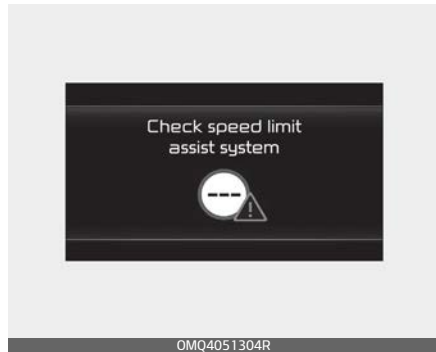

When Intelligent Speed Limit Assist is not working properly, the warning message will appear on the cluster for a seconds and the master warning light will illuminate. If this occurs, we recommend the function checked by an authorised Kia dealer/service partner.

Intelligent Speed Limit Assist disabled



OMQ4051305R

When the front windscreen where the front view camera is located is covered with foreign material, such as snow or rain, it can reduce the detecting performance and temporarily limit or disable Intelligent Speed Limit Assist.

If this occurs, the 'Speed limit system disabled. Camera obscured' warning message will appear on the cluster. The function will operate normally when snow, rain or foreign material is removed.

If the function does not operate normally after it is removed, we recommend the function checked by an authorised Kia dealer/service partner.

*** NOTICE**

- Even though the warning message or warning light does not appear on the cluster, Intelligent Speed Limit Assist may not operate properly.

Limitations

Intelligent Speed Limit Assist may not operate normally, or the function may operate unexpectedly under the following circumstances :

- The road sign is contaminated or indistinguishable
 - The road sign is difficult to see due to bad weather, such as rain, snow, fog, etc.
 - The road sign is not clear or damaged
 - The road sign is partially obscured by surrounding objects or shadow
- The road signs do not conform to the standard
 - The text or picture on the road sign is different from the standard
 - The road sign is installed between the main line and the exit road or between diverging roads
 - A conditional road sign is not installed with a sign located on the road to enter or exit
 - A sign is attached to another vehicle

- The brightness changes suddenly, for example when entering or exiting a tunnel or passing under a bridge
- Headlamps are not used or the brightness of the headlamps are weak at night or in the tunnel
- Road signs are difficult to recognise due to the reflection of sunlight, street lights, or oncoming vehicles
- The field of view of the front view camera is obstructed by sun glare
- Driving on a road that is sharply curved or continuously curved
- Driving through speed bumps, or driving up and down or left to right on steep inclines
- The vehicle is shaking heavily
- Wrongly recognised the road sign or numbers and pictures including sign in the limit speed.
- When a sign on another nearby road is mistakenly recognised as a sign on the road you are driving.
- When multiple signs are installed together
- If the minimum speed limit sign is mistakenly recognised as the maximum speed limit sign
- If there is an error in the navigation map or GPS information
- If the driver do not drive on the navigation guide route
- When driving on a newly opened road

WARNING

- Intelligent Speed Limit Assist is a supplemental function that helps the driver to comply with the speed limit on the road, and may not display the correct speed limit or control the driving speed properly.
- Always set the vehicle speed to the speed limit in your country.

CAUTION

For more details on the limitations of the front view camera, refer to "Forward Collision-Avoidance Assist (FCA) (Sensor fusion) (if equipped)" on page 6-78.

Driver Attention Warning (DAW) (if equipped)

Basic function

Driver Attention Warning will help determine the driver's attention level by analyzing driving pattern, driving time, etc. whilst vehicle is being driven. The function will recommend a break when the driver's attention level falls below a certain level.

Leading vehicle departure alert function

Leading Vehicle Departure Alert function will inform the driver when the front vehicle departs from a stop.

Detecting sensor

Front view camera



The front view camera is used as a detecting sensor to detect driving

patterns and front vehicle departure whilst vehicle is being driven.

Refer to the picture above for the detailed location of the detecting sensor.

⚠ CAUTION

Always keep the front view camera in good condition to maintain optimal performance of Driver Attention Warning.

For more details on the precautions of the front view camera, refer to "Forward Collision-Avoidance Assist (FCA) (Sensor fusion) (if equipped)" on page 6-78.

Driver Attention Warning Settings

Setting

Driver Attention Warning

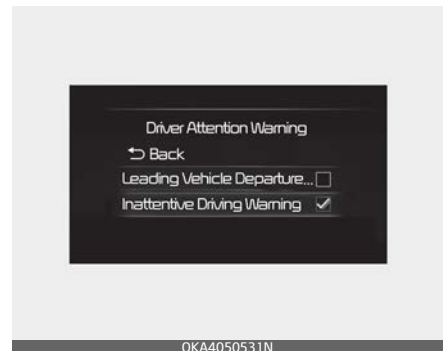

With the ENGINE START/STOP button in the ON position, select or deselect 'Driver Assistance → Driver Attention Warning' from the Settings menu to set whether or not to use each function.

- If 'Inattentive Driving Warning' is selected, the function will inform the driver the driver's attention level and will recommend taking a break when the level falls below a certain level.

*** NOTICE**

If the engine is restarted, Driver Attention Warning will maintain the last setting.

Leading Vehicle Departure Alert



If 'Leading Vehicle Departure Alert' is selected, the function will inform the driver when the front vehicle departs from a stop.

Warning timing



With the ENGINE START/STOP button in the ON position, select 'Driver Assistance → Warning Timing' from the Settings menu to change the initial warning activation time for Driver Attention Warning.

When the vehicle is first delivered, warning timing is set to 'Normal'. If you change the warning timing, the warning time of other Driver Assistance systems may change.

*** NOTICE**

If the engine is restarted, Driver Warning Time will maintain the last setting.

Function operation

Basic function

Function display and warning

The basic function of Driver Attention Warning is to inform the driver the 'Attention Level' and to warn the driver 'Consider taking a break'.

Attention level

Function off



Standby



Attentive driving



Inattentive driving



- The driver can monitor his/her driving conditions on the cluster.
 - When the 'Inattentive Driving Warning' is deselected from the Settings menu, 'System Off' is displayed.
 - The function will operate when vehicle speed is between 0 ~ 180 km/h (0 ~ 110 mph).
 - When vehicle speed is not within the operating speed, the message 'Standby' will be displayed.

- The driver's attention level is displayed on the scale of 1 to 5. The more inattentive the driver is, the lower the level is.
- The level decreases when the driver does not take a break for a certain period of time.

Taking a break



- The 'Consider taking a break' message will appear on the cluster and an audible warning will sound to suggest that the driver take a break, when the driver's attention level is below 1.
- Driver Attention Warning will not suggest a break when the total driving time is shorter than 10 minutes or 10 minutes has not passed after the last break was suggested.

⚠ WARNING

For your safety, change the Settings after parking the vehicle at a safe location.

⚠ CAUTION

- Driver Attention Warning may suggest a break depending on the driver's driving pattern or habits, even if the driver doesn't feel fatigue.
- Driver Attention Warning is a supplemental function and may not be able to determine whether the driver is inattentive.
- The driver who feels fatigued should take a break at a safe location, even though there is no break suggestion by Driver Attention Warning.

*** NOTICE**

- For more details on setting the functions in the infotainment system, refer to "Instrument cluster" on page 5-71.
- Driver Attention Warning will reset the last break time to 00:00 in the following situations:
 - The engine is turned off
 - The driver unfastens the seat belt and opens the driver's door.
 - The vehicle is stopped for more than 10 minutes.
- When the driver resets Driver Attention Warning, the last break time is set to 00:00 and the driver's attention level is set to High.

Leading vehicle departure alert function



OMQ4041507R

When the front vehicle departs from a stop, Leading Vehicle Departure Alert will inform the driver by displaying the 'Leading vehicle is driving on' message on the cluster and an audible warning will sound.

⚠ WARNING

- If any other function's warning message is displayed or audible warning is generated, Leading Vehicle Departure Alert warning message may not be displayed and audible warning may not be generated.
- The driver should hold the responsibility to safely drive and control the vehicle.

⚠ CAUTION

- Leading Vehicle Departure Alert is a supplemental function and may not alert the driver whenever the front vehicle departs from a stop.
- Always check the front of the vehicle and road conditions before departure.
- Depending on the instrument panel specifications or theme, images or colours may be displayed differently.

Driver Attention Warning Malfunction and Limitations

Driver Attention Warning Malfunction and Limitations



OMQ4050118L

When Driver Attention Warning is not working properly, the 'Check Driver Attention Warning (DAW) system' warning message will appear on the cluster. If this occurs, we recommend that you have your

vehicle inspected by an authorised Kia dealer/service partner.

Limitations of Driver Attention Warning

Driver Attention Warning may not work properly in the following situations:

- The vehicle is driven violently
- The vehicle intentionally crosses over lanes frequently
- The vehicle is controlled by Driver Assistance system, such as Lane Keeping Assist

Leading vehicle departure alert feature

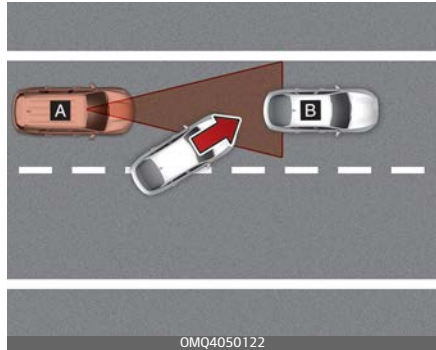
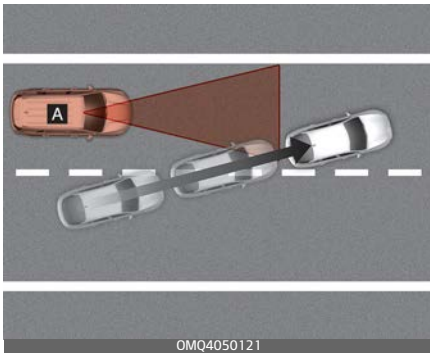

- [A]: Your vehicle, [B]: Front vehicle
- When the vehicle ahead sharply steers

If the vehicle in front makes a sharp turn, such as to turn left or right or make a U- turn, etc., Leading Vehicle Departure Alert may not operate properly.

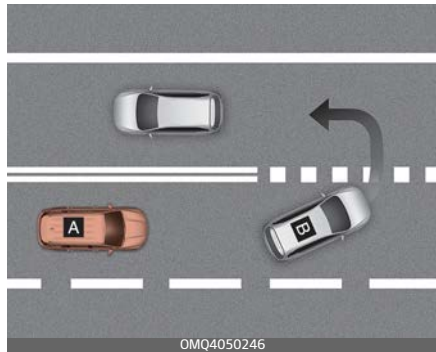

- [A]: Your vehicle, [B]: Front vehicle
- When the vehicle cuts in

If a vehicle cuts in front of your vehicle, Leading Departure Alert may not operate properly.

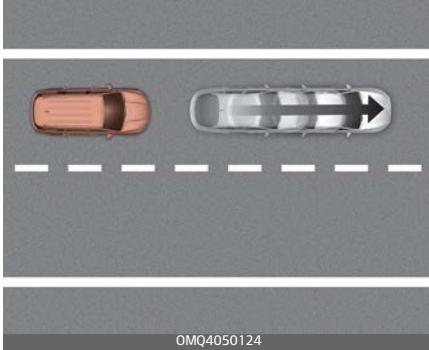

- When the vehicle ahead abruptly departs

If the vehicle in front abruptly departs, Leading Vehicle Departure Alert may not operate properly.



- When a pedestrian or bicycle is between you and the vehicle ahead

If there is a pedestrian(s) or bicycle(s) in between you and the vehicle in front, Leading Vehicle Departure Alert may not operate properly.

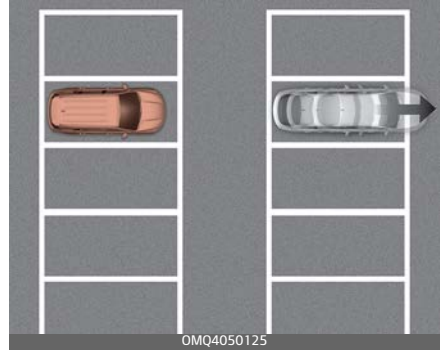

- When in a parking lot

If a vehicle parked in front drives away from you, Leading Vehicle Departure Alert may alert you that the parked vehicle is driving away.



- The vehicle in front is difficult to be specified

If you pass a tollgate or intersection with lots of vehicles or you drive where lanes are merged or divided frequently, Leading Vehicle Departure Alert may not operate properly.

CAUTION

For more details on the limitations of the front view camera, refer to "Forward Collision-Avoidance Assist (FCA) (Sensor fusion) (if equipped)" on page 6-78.

Blind-Spot View Monitor (BVM) (if equipped)

Left side



Right side

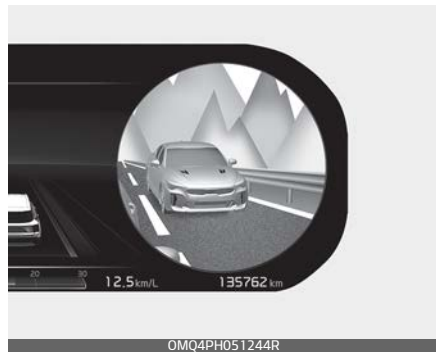

Blind-Spot View Monitor displays the rear side blind spot area of the vehicle in the cluster when the turn signal is turned on to help safely change lanes.

WARNING

Vehicles may look closer than they actually are. Failure to visually confirm that it is safe to change lanes

before doing so may result in an accident leading to serious injury.

* If your vehicle is equipped with an infotainment system, you can learn how to setup on the website via QR code in the infotainment quick reference guide.

Detecting sensor

SVM-side view camera



(camera located at bottom of the mirror)

Refer to the picture above for the detailed location of the detecting sensors.

⚠ WARNING

The image shown on the cluster may differ from the actual distance of the object. Make sure to directly check the vehicle's surroundings for safety.

⚠ CAUTION

If the camera lens is covered with foreign material, Blind-Spot View Monitor may not operate normally. Always keep the camera lens clean. However, do not use chemical solvents such as strong detergents containing high alkaline or volatile organic solvents (petrol, acetone etc.). This may damage the camera lens.

Blind-Spot View Monitor Settings

Blind-Spot View

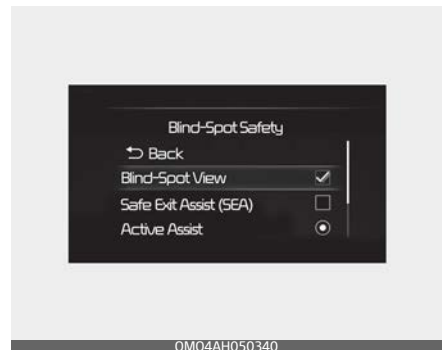

With the ENGINE START/STOP button in the ON position, select 'Driver Assistance → Blind-Spot Safety → Blind Spot View' from the Settings menu to turn on Blind-Spot View Monitor and deselect to turn off the function.

Blind-Spot View Monitor Operation

Operating conditions

- ENGINE START/STOP button is in the OFF position
- Turn signal is ON

Off conditions

- ENGINE START/STOP button is in the OFF position
- Turn signal is OFF
- Hazard warning flasher is ON
- Other warnings pops up and takes priority over the Blind-Spot View Monitor

Blind-Spot View Monitor Malfunction

When Blind-Spot View Monitor is not working properly, or the cluster display flickers, or the camera image does not display normally, we recommend that you have your vehicle inspected by an authorised Kia dealer/service partner.

Cruise Control (CC) (if equipped)



(1) Cruise indicator

(2) Set speed

Cruise Control will allow you to drive at speeds above 30 km/h (20 mph) without depressing the accelerator pedal.

* NOTICE

During normal cruise control operation, when the - switch is activated or reactivated after applying the brakes, Cruise Control will energize after approximately 3 seconds. This delay is normal.

* NOTICE

To activate cruise control, depress the brake pedal at least once after turning the ignition switch or ENGINE START/STOP button to the ON position or starting the engine.

⚠ WARNING**Misuse of Cruise Control**

Do not use cruise control if the traffic situation does not allow you to drive safely at a constant speed and with sufficient distance to the vehicle in front.

Cruise Control Operation**Setting speed**

1. Accelerate to the desired speed, which must be more than 30 km/h (20 mph).



2. Press the Driving Assist (MODE) button at the desired speed. The set speed and Cruise (CRUISE) indicator will illuminate on the cluster.
3. Release the accelerator pedal. Vehicle speed will maintain the set speed even when the accelerator pedal is not depressed.

*** NOTICE**

On a steep slope, the vehicle may slightly slow down or speed up whilst driving uphill or downhill.

Increasing speed

- Push the + switch up and release it immediately. The cruising speed will increase by 1 km/h (1 mph) each time the switch is operated in this manner.
- Push the + switch up and hold it whilst monitoring the set speed on the cluster. The cruising speed will increase to the nearest multiple of ten at first, and then increase by 10 km/h (5 mph) each time the switch is operated in this manner. Release the switch when the desired speed is shown and the vehicle will accelerate to that speed.

Decreasing speed

- Push the - switch down and release it immediately. The cruising speed will decrease by 1 km/h (1 mph) each time the switch is operated in this manner.
- Push the - switch down and hold it whilst monitoring the set speed on the cluster. The cruising speed will decrease to the nearest multiple of ten at first, and then decrease by 10 km/h (5 mph) each time the switch is operated in this manner. Release the switch at the speed you want to maintain.

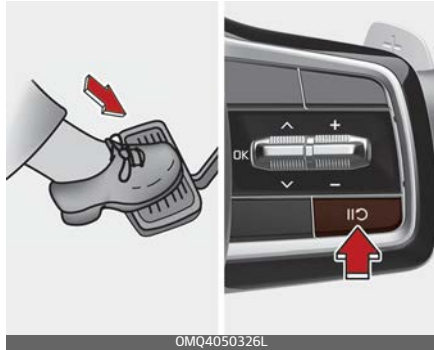
Temporarily cancelling the function

Cruise Control will be cancelled when:

- Depressing the brake pedal.
- Pressing the (||) button.
- Shifting the gear to N (Neutral).
- Decreasing vehicle speed to less than approximately 30 km/h (20 mph).
- ESC (Electronic Stability Control) is operating.
- The vehicle speed is above 193 km/h (120 mph)

The set speed will turn off but the Cruise (CRUISE) indicator will stay on.

Resuming the function



Push the +, - switch or (|||) button.

If you push the + switch up or - switch down, vehicle speed will be set to the current speed on the cluster.

If you press the (|||) button, vehicle speed will resume to the preset speed.

Vehicle speed must be above 30 km/h (20 mph) for the function to resume.

Turning off the function



Press the Driving Assist (MODE) button to turn Cruise Control off. The Cruise (CRUISE) indicator will go off.

Always press the Driving Assist (MODE) button to turn Cruise Control off when not in use.

* NOTICE

Take the following precautions when using Cruise Control:

- Always set the vehicle speed under the speed limit in your country.
- Keep Cruise Control off when the function is not in use, to avoid inadvertently setting a speed. Check that the Cruise (CRUISE) indicator is off.
- Cruise Control does not substitute for proper and safe driving. It is the responsibility of the driver to always drive safely and should always be aware of unexpected and sudden situations from occurring.
- Always drive cautiously to prevent unexpected and sudden situations from occurring. Pay attention to the road conditions at all times.
- Do not use Cruise Control when it may be unsafe to keep the vehicle at a constant speed:
 - When driving in heavy traffic, or when traffic conditions make it difficult to drive at a constant speed
 - When driving on rainy, icy, or snow-covered roads
 - When driving on hilly or windy roads

- When driving in windy areas
 - When driving with limited view (possibly due to bad weather, such as fog, snow, rain and sandstorm)
 - Do not use Cruise Control when towing a trailer.
-

Smart Cruise Control (SCC) (if equipped)

Smart Cruise Control is designed to detect the vehicle ahead and help maintain the desired speed and minimum distance with the vehicle ahead.

Overtaking Acceleration Assist

Whilst Smart Cruise Control is operating, if the function judges that the driver is determined to overtake the vehicle in front, acceleration will be assisted.

Detecting sensor

Front view camera



Front radar



The front view camera and front radar are used as a detecting sensor to detect front vehicles.

Refer to the picture above for the detailed location of the detecting sensor.

⚠ CAUTION

Always keep the front view camera and front radar in good condition to maintain optimal performance of Smart Cruise Control. For more details on the precautions of the front view camera and front radar, refer to "Forward Collision-Avoidance Assist (FCA) (Sensor fusion) (if equipped)" on page 6-78.

Function settings

Setting

To turn on Smart Cruise Control



- Press the Driving Assist (MODE) button to turn on the function. The speed will be set to the current speed on the cluster.
- If there is no vehicle in front of you, the set speed will be maintained, but if there is a vehicle in front of you, the speed may decrease to maintain the distance to the vehicle ahead. If the vehicle ahead accelerates, your vehicle will travel at a steady cruising speed after accelerating to the set speed.

* NOTICE

If your vehicle speed is between 0 ~ 30 km/h (0 ~ 20 mph) when you press the Driving Assist (MODE) button, the Smart Cruise Control

speed will be set to 30 km/h (20 mph).

restarted, or when the function was temporarily cancelled.

To set vehicle distance



Each time the Vehicle Distance button is pressed, the vehicle distance changes as follows:

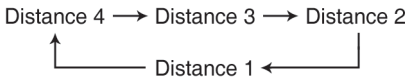

*** NOTICE**

- If you drive at 90 km/h (56 mph), the distance is maintained as follows:
 - Distance 4 - approximately 52.5 m (172 ft.)
 - Distance 3 - approximately 40 m (130 ft.)
 - Distance 2 - approximately 32.5 m (106 ft.)
 - Distance 1 - approximately 25 m (82 ft.)
- The distance is set to the last set distance when the engine is

To increase set speed



- Push the + switch up and release it immediately. The cruising speed will increase by 1 km/h (1 mph) each time the switch is operated in this manner.
- Push the + switch up and hold it whilst monitoring the set speed on the cluster. The cruising speed will increase by 10 km/h (5 mph) each time the switch is operated in this manner. Release the switch when the desired speed is shown, and the vehicle will accelerate to that speed. You can set the speed to 180 km/h (110 mph).

⚠ WARNING

Check the driving condition before using the + switch. Driving speed may sharply increase when you push up and hold the + switch.

To decrease set speed



OMQ4051130L

- Push the - switch down and release it immediately. The cruising speed will decrease by 1 km/h (1 mph) each time the switch is operated in this manner.
- Push the - switch down and hold it whilst monitoring the set speed on the cluster. The cruising speed will decrease by 10 km/h (5 mph) each time the switch is operated in this manner.

Release the switch at the speed you want to maintain. You can set the speed to 30 km/h (20 mph).

To temporarily cancel Smart Cruise Control

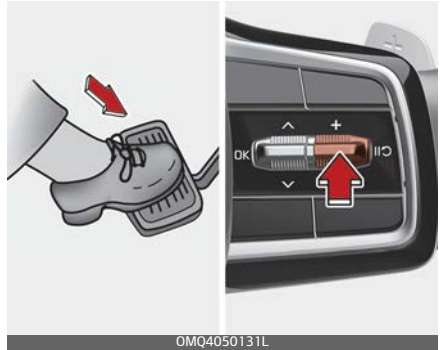

OMQ4050131L

Press the (|| C) switch or depress the brake pedal to temporarily cancel Smart Cruise Control.

To resume Smart Cruise Control



OMQ4050205

To resume Smart Cruise Control after the function was cancelled, push the +, - or (|| C) switch.

If you push the + switch up or - switch down, vehicle speed will be set to the current speed on the cluster.

If you push the (|| C) switch, vehicle speed will resume to the preset speed.

⚠ WARNING

Check the driving condition before using the (||⌚) switch. Driving speed may sharply increase or decrease when you press the (||⌚) switch.

To turn off Smart Cruise Control



Press the Driving Assist (MODE) button to turn Smart Cruise Control off.

*** NOTICE**

If your vehicle is equipped with Manual Speed Limit Assist, press and hold the Driving Assist (MODE) button to turn off Smart Cruise Control. However Manual Speed Limit Assist will turn on.

Based on DRIVE MODE

Smart Cruise Control will change acceleration based on the drive mode selected from DRIVE MODE Integrated Control function. Refer to the following chart.

DRIVE MODE	Smart Cruise Control
ECO	Slow
SPORT	Fast
SMART	Normal

*** NOTICE**

- For more details on DRIVE MODE, refer to "Drive mode integrated control system" on page 6-59.
- In vehicles without Drive Mode, Smart Cruise Control accelerate the vehicle in 'Normal' level.

Warning volume

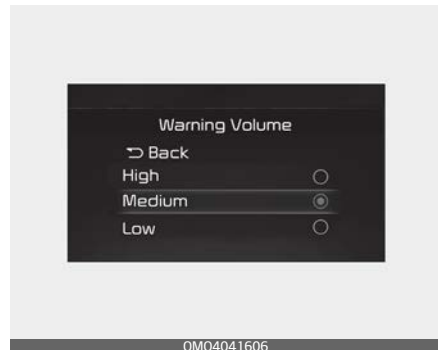

With the ENGINE START/STOP button in the ON position, select 'Driver Assistance → Warning Volume' from the Settings menu to change the

Warning Volume 'High', 'Medium', 'Low' or 'Off' for Smart Cruise Control.

However, even if 'Off' is selected, the function's Warning Volume will not turn off but the volume will sound as 'Low'.

If you change the Warning Volume, the Warning Volume of other Driver Assistance systems may change.

* NOTICE

If the engine is restarted, Warning Volume will maintain the last setting.

- ESC (Electronic Stability Control), TCS (Traction Control System) or ABS is on, but not controlling the vehicle
- Engine RPM is not in the red zone
- Forward Collision-Avoidance Assist brake control is not operating
- ISG function is not operating

* NOTICE

At a stop, if there is no vehicle in front of your vehicle, the function will turn on when the brake pedal is depressed.

Smart Cruise Control Operation

Operating conditions

Smart Cruise Control will operate when the following conditions are satisfied.

Basic function

- The gear is in D (Drive)
- The driver's door is closed
- EPB (Electronic Parking Brake) is not applied
- Your vehicle speed is within the operating speed range
 - 10 ~ 180 km/h (5 ~ 110 mph):
when there is no vehicle in front
 - 0 ~ 180 km/h (0 ~ 110 mph):
when there is a vehicle in front

Overtaking Acceleration Assist

Overtaking Acceleration Assist will operate when the turn signal indicator is turned on to the left (left-hand drive) or turned on to the right (right-hand drive) whilst Smart Cruise Control is operating, and the following conditions are satisfied:

- Your vehicle speed is above 60 km/h (40 mph)
- The hazard warning flasher is off
- A vehicle is detected in front of your vehicle
- Deceleration is not needed to maintain distance with the vehicle in front

⚠ WARNING

- When the left turn signal indicator is turned on whilst there is a vehicle ahead, the vehicle may accelerate temporarily. Pay attention to the road conditions at all times.
- Regardless of your countries driving direction, Overtaking Acceleration Assist will operate when the conditions are satisfied. When using the function in countries with different driving direction, always check the road conditions at all times.

Smart Cruise Control Display and Control

Basic function

You can see the status of the Smart Cruise Control operation in the Utility view on the cluster. Refer to "Instrument cluster" on page 5-71.

Smart Cruise Control will be displayed as below depending on the status of the function.

- When operating

Operating



1. Whether there is a vehicle ahead and the selected distance level are displayed.
 2. Set speed is displayed.
 3. Whether there is a vehicle ahead and the selected target distance are displayed.
- When temporarily cancelled

Temporarily cancelled



1. (CRUISE) indicator is displayed.
 2. The previous set speed is shaded.
- Vehicle ahead and distance level are not displayed.

* NOTICE

- The distance of the front vehicle on the cluster is displayed according to the actual distance between your vehicle and the vehicle ahead.
- The target distance may vary according to the vehicle speed and the set distance level. If vehicle speed is low, even though the vehicle distance have changed, the change of the target vehicle distance may be small.

To temporarily accelerate

OMQ4PH050376L

If you want to speed up temporarily when Smart Cruise Control is on, depress the accelerator pedal. Whilst the speed is increasing, the set speed, distance level and target distance will blink on the cluster.

⚠ WARNING

Be careful when accelerating temporarily, because the speed and distance is not controlled automatically even if there is a vehicle in front of you.

Smart Cruise Control temporarily cancelled

OMQ4050134R

Smart Cruise Control will be temporarily cancelled automatically when:

- The vehicle speed is above 190 km/h (120 mph)
- The accelerator pedal is continuously depressed for a certain period of time
- The conditions for the Smart Cruise Control to operate is not satisfied

If the function is temporarily cancelled automatically, the 'SCC (Smart Cruise Control) cancelled' warning message will appear on the cluster, and an audible warning will sound to warn the driver.

If Smart Cruise Control is temporarily cancelled whilst the vehicle is at a standstill with the function operating, EPB (Electronic Parking Brake) maybe applied.

⚠ WARNING

When the function is temporarily cancelled, distance with the front vehicle will not be maintained. Always have your eyes on the road whilst driving, and if necessary, depress the brake pedal to reduce your driving speed in order to maintain a safe distance.

Smart Cruise Control conditions not satisfied



If the Driving Assist (MODE) button, + switch, - switch or (|| ⤷) switch is pushed when the function's operating conditions are not satisfied, the 'SCC (Smart Cruise Ctrl.) conditions not met' will appear

on the cluster, and an audible warning will sound.

In traffic situation



In traffic, your vehicle will stop if the vehicle ahead of you stops. Also, if the vehicle ahead of you starts moving, your vehicle will start as well.

In addition, after the vehicle has stopped and a certain time have passed, the 'Leading vehicle is driving on' message will appear on the cluster. Depress the accelerator pedal or push the + switch, - switch or (|| ⤷) switch to start driving.

⚠ WARNING

Whilst the message is displayed on the cluster, if there is no vehicle in front or the vehicle is far away from you, and the + switch, - switch or (|| ⤷) switch is pushed, Smart Cruise Control will automatically cancel and the EPB will be applied. However, if the accelerator pedal is depressed,

EPB will not be applied even though the function is cancelled. Always pay attention to the road condition ahead.

Warning road conditions ahead



OMQ4050142R

In the following situation, the 'Watch for surrounding vehicles' warning message will appear on the cluster, and an audible warning will sound to warn the driver of road conditions ahead.

- The vehicle in front disappears when Smart Cruise Control is maintaining the distance with the vehicle ahead whilst driving below a certain speed.

⚠ WARNING

Always pay attention to vehicles or objects that may suddenly appear in front of you, and if necessary, depress the brake pedal to reduce your driving speed in order to maintain a safe distance.

Collision warning



OMQ4050071R

Whilst Smart Cruise Control is operating, when the collision risk with the vehicle ahead is high, the 'Collision Warning' warning message will appear on the cluster, and an audible warning will sound to warn the driver. Always have your eyes on the road whilst driving, and if necessary, depress the brake pedal to reduce your driving speed in order to maintain a safe distance.

*** NOTICE**

In the following situations, Smart Cruise Control may not warn the driver of a collision.

- The distance from the front vehicle is near, or the vehicle speed of the front vehicle is faster or similar with your vehicle
- The speed of the front vehicle is very slow or is at a standstill
- The accelerator pedal is depressed right after Smart Cruise Control is turned on

⚠ WARNING

Take the following precautions when using Smart Cruise Control:

- Smart Cruise Control does not substitute for proper and safe driving. It is the responsibility of the driver to always check the speed and distance to the vehicle ahead.
- Smart Cruise Control may not recognise unexpected and sudden situations or complex driving situations, so always pay attention to driving conditions and control your vehicle speed.
- Keep Smart Cruise Control off when the function is not in use to avoid inadvertently setting a speed.
- Do not open the door or leave the vehicle when Smart Cruise Control is operating, even if the vehicle is stopped.
- Always be aware of the selected speed and vehicle to vehicle distance.
- Keep a safe distance according to road conditions and vehicle speed. If the vehicle to vehicle distance is too close during high-speed driving, a serious collision may result.
- When maintaining distance with the vehicle ahead, if the front vehicle disappears, the function may suddenly accelerate to the set speed. Always be aware of unexpected and sudden situations from occurring.
- Vehicle speed may decrease on an upward slope and increase on a downward slope.
- Always be aware of situations such as when a vehicle cuts in suddenly.
- When you are towing a trailer or another vehicle, we recommend that Smart Cruise Control is turned off due to safety reasons.
- Turn off Smart Cruise Control when your vehicle is being towed.
- Smart Cruise Control may not operate normally if interfered by strong electromagnetic waves.
- Smart Cruise Control may not detect an obstacle in front and lead to a collision. Always look ahead cautiously to prevent unexpected and sudden situations from occurring.
- Vehicles moving in front of you with a frequent lane change may cause a delay in the function's reaction or may cause the function to react to a vehicle actually in an adjacent lane. Always drive cautiously to prevent unexpected and sudden situations from occurring.
- Always be aware of the surroundings and drive safely, even though a warning message does not appear or an audible warning does not sound.

- If any other function's warning message is displayed or warning sound is generated, Smart Cruise Control warning message may not be displayed and warning sound may not be generated.
- You may not hear the warning sound of Smart Cruise Control if the surrounding is noisy.
- The vehicle manufacturer is not responsible for any traffic violation or accidents caused by the driver.
- Always set the vehicle speed under the speed limit in your country.

* NOTICE

- Smart Cruise Control may not operate for a few seconds after the vehicle is started or the front view camera or front radar is initialised.
- You may hear a sound when the brake is controlled by Smart Cruise Control.

Smart Cruise Control Malfunction and Limitations

Smart Cruise Control malfunction

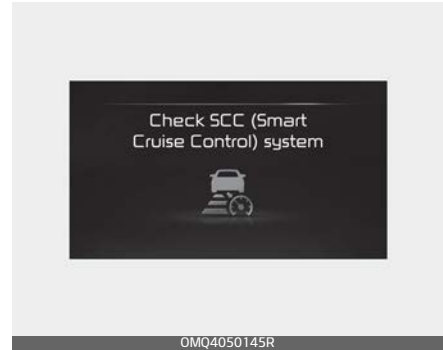

When Smart Cruise Control is not working properly, the 'Check SCC (Smart Cruise Control) system' warning message will appear, and the (⚠️) warning light will illuminate on the cluster. Have the function be inspected by an authorised Kia dealer.

Smart Cruise Control disabled

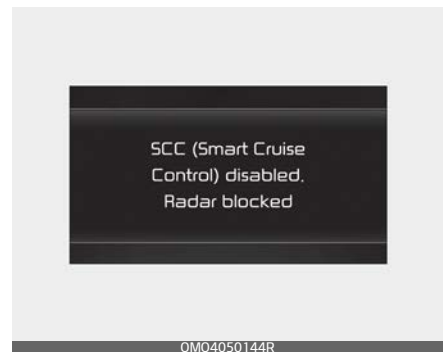

When the front radar cover or sensor is covered with snow, rain, or

foreign material, it can reduce the detecting performance and temporarily limit or disable Smart Cruise Control.

If this occurs, the 'SCC (Smart Cruise Control) disabled. Radar blocked' warning message will appear for a certain period of time on the cluster.

The function will operate normally when snow, rain or foreign material is removed.

WARNING

Even though the warning message does not appear on the cluster, Smart Cruise Control may not properly operate.

CAUTION

Smart Cruise Control may not properly operate in an area (e.g. open terrain), where there is nothing to detect after turning ON the engine.

Limitations

Smart Cruise Control may not operate normally, or the function may operate unexpectedly under the following circumstances:

- The detecting sensor or the surroundings are contaminated or damaged
- Washer fluid is continuously sprayed, or the wiper is on
- The camera lens is contaminated due to tinted, filmed or coated windscreen, damaged glass, or stuck of foreign material (sticker, bug, etc.) on the glass
- Moisture is not removed or frozen on the windscreen
- The field of view of the front view camera is obstructed by sun glare
- Street light or light from an oncoming vehicle is reflected on the wet road surface, such as a puddle on the road
- The temperature around the front view camera is high or low
- An object is placed on the dashboard
- The surrounding is very bright
- The surrounding is very dark, such as in a tunnel, etc.
- The brightness changes suddenly, for example when entering or exiting a tunnel
- The brightness outside is low, and the headlamps are not on or are not bright
- Driving in heavy rain or snow, or thick fog
- Driving through steam, smoke or shadow
- Only part of the vehicle is detected
- The vehicle in front has no taillamps, taillamps are located unusually, etc.
- The brightness outside is low, and the taillamps are not on or are not bright

- The rear of the front vehicle is small or does not look normal (i.e. tilted, overturned, etc.)
- The front vehicle's ground clearance is low or high
- A vehicle suddenly cuts in front
- Your vehicle is being towed
- Driving through a tunnel or iron bridge
- Driving near areas containing metal substances, such as a construction zone, railroad, etc.
- A material is near that reflects very well on the front radar, such as a guardrail, nearby vehicle, etc.
- The bumper around the front radar is impacted, damaged or the front radar is out of position
- The temperature around the front radar is high or low
- Driving in large areas where there are few vehicles or structures (i.e. desert, meadow, suburb, etc.)
- The vehicle in front is made of material that does not reflect on the front radar
- Driving near a highway (or motorway) interchange or tollgate
- Driving on a slippery surface due to snow, water puddle, ice, etc.
- Driving on a curved road
- The vehicle in front is detected late
- The vehicle in front is suddenly blocked by an obstacle
- The vehicle in front suddenly changes lane or suddenly reduces speed
- The vehicle in front is bent out of shape
- The front vehicle's speed is fast or slow
- With a vehicle in front, your vehicle changes lane at low speed
- The vehicle in front is covered with snow
- Unstable driving
- You are on a roundabout and the vehicle in front is not detected
- You are continuously driving in a circle
- Driving in a parking lot
- Driving through a construction area, unpaved road, partial paved road, uneven road, speed bumps, etc.
- Driving on an incline road, curved road, etc.
- Driving through a roadside with trees or streetlights
- Your vehicle is moving unstable
- The adverse road conditions cause excessive vehicle vibrations whilst driving
- Your vehicle height is low or high due to heavy loads, abnormal tyre pressure, etc.
- Driving through a narrow road where trees or grass are overgrown
- There is interference by electromagnetic waves, such as driving in an area with strong radio waves or electrical noise

- Driving on a curve



On curves, Smart Cruise Control may not detect a vehicle in the same lane, and may accelerate to the set speed. Also, vehicle speed may rapidly decrease when the vehicle ahead is detected suddenly.

Select the appropriate set speed on curves and apply the brake pedal or accelerator pedal according to the road and driving conditions ahead.



Your vehicle speed can be reduced due to a vehicle in the adjacent lane.

Apply the accelerator pedal and select the appropriate set speed. Check to be sure that the road conditions permit safe operation of the Smart Cruise Control.

- Driving on a slope



During uphill or downhill driving, the Smart Cruise Control may not detect a moving vehicle in your lane, and cause your vehicle to accelerate to the set speed. Also, vehicle speed will rapidly decrease when the vehicle ahead is detected suddenly.

Select the appropriate set speed on inclines and apply the brake pedal or accelerator pedal according to the road and driving conditions ahead.

• Changing lanes

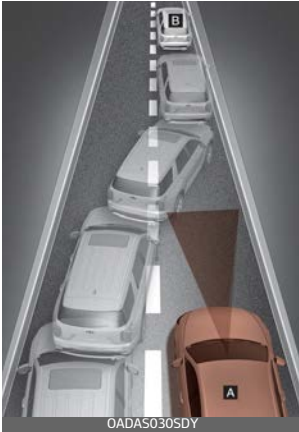

[A]: Your vehicle

[B]: Lane changing vehicle

When a vehicle moves into your lane from an adjacent lane, it cannot be detected by the sensor until it is in the sensor's detection range. Smart Cruise Control may not immediately detect the vehicle when the vehicle changes lanes abruptly. In this case, you must maintain a safe braking distance, and if necessary, depress the brake pedal to reduce your driving speed in order to maintain a safe distance.

• Detecting vehicle

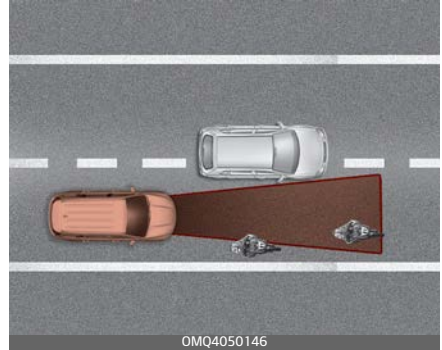

In the following cases, some vehicles in your lane cannot be detected by the sensor:

- Vehicles offset to one side
- Slow-moving vehicles or sudden-decelerating vehicles
- Oncoming vehicles
- Stopped vehicles
- Vehicles with small rear profile, such as trailers
- Narrow vehicles, such as motorcycles or bicycles
- Special vehicles
- Animals and pedestrians

Adjust your vehicle speed by depressing the brake pedal according to the road and driving conditions ahead.

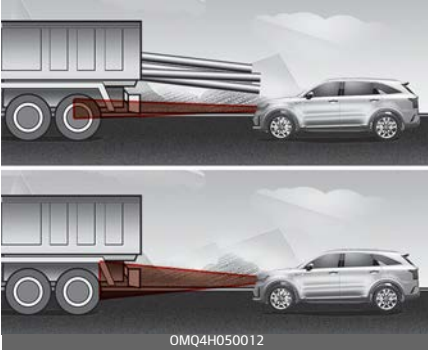

In the following cases, the vehicle in front cannot be detected by the sensor:

- Vehicles with higher ground clearance or vehicles carrying loads that stick out of the back of the vehicle
- Vehicles that has the front lifted due to heavy loads
- You are steering your vehicle
- Driving on narrow or sharply curved roads

Adjust your vehicle speed by depressing the brake pedal according to the road and driving conditions ahead.

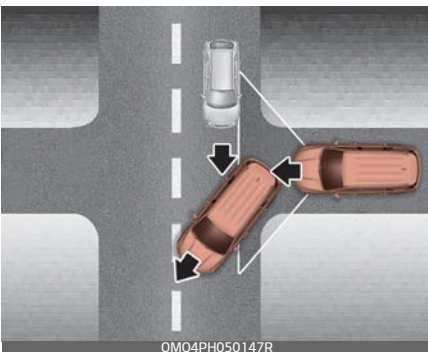

- When a vehicle ahead disappears at an intersection, your vehicle may accelerate. Always pay attention to road and driving conditions whilst driving.

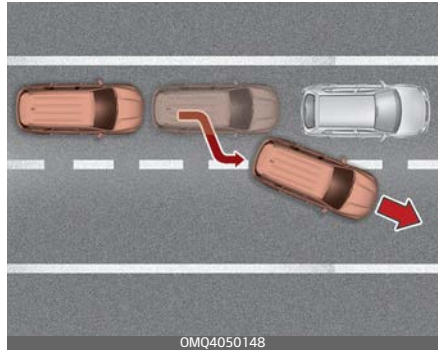

- When a vehicle in front of you merges out of the lane, Smart Cruise Control may not immediately detect the new vehicle that is now in front of you. Always pay attention to road and driving conditions whilst driving.

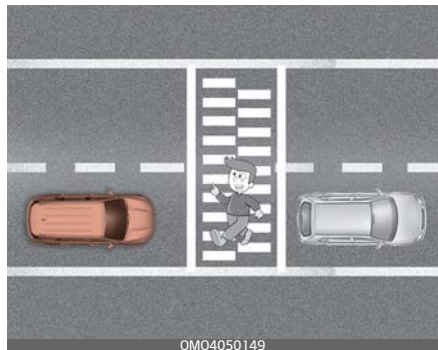

- Always look out for pedestrians when your vehicle is maintaining a distance with the vehicle ahead.

Navigation-based Smart Cruise Control (NSCC) (if equipped)

Navigation-based Smart Cruise Control will help automatically adjust vehicle speed when driving on highways (or motorways) by using road information from the navigation function whilst Smart Cruise Control is operating.

Recommend adding Warning:

"Navigation-based Smart Cruise Control (NSCC) is a supplemental system and is not a substitute for safe driving. It is the responsibility of the driver to always check the speed and distance to the vehicle ahead. Always drive safely and use caution."

Highway Curve Zone Auto Slowdown

If vehicle speed is high, Highway Curve Zone Auto Slowdown function will temporarily decelerate your vehicle or limit acceleration to help you drive safely on a curve based on the curve information from the navigation.

Highway Set Speed Auto Change

Highway Set Speed Auto Change function automatically changes Smart Cruise Control set speed based on the speed limit information from the navigation.

Navigation-based Smart Cruise Control settings

Setting



With the ENGINE START/STOP button in the ON position, select 'Driver Assistance → Driving Assist → Highway Auto Speed Change' from the Settings menu to turn on Navigation-based Smart Cruise Control and deselect to turn off the function.

* NOTICE

When there is a problem with Navigation-based Smart Cruise Control, the function cannot be set from the Settings menu.

Navigation-based Smart Cruise Control operation

Navigation-based Smart Cruise Control conditions

Navigation-based Smart Cruise Control is ready to operate if all of the following conditions are satisfied:

- Smart Cruise Control is operating
- Driving on main roads of highways (or motorways)

* NOTICE

For more details on how to operate Smart Cruise Control, refer to "Smart Cruise Control (SCC) (if equipped)" on page 6-146.

Function display and control

When Navigation-based Smart Cruise Control operates, it will be displayed on the cluster as follows:

Navigation-based Smart Cruise Control standby



If the operating conditions are satisfied, the white (AUTO) symbol will illuminate.

Navigation-based Smart Cruise Control operating



If temporary deceleration is required in the standby state and Navigation-based Smart Cruise Control is operating, the green (AUTO) symbol will illuminate on the cluster.

If the Highway Set Speed Auto Change function operates, the green

(**AUTO**) symbol and set speed will illuminate on the cluster, and an audible warning will sound.

⚠ WARNING

'Drive carefully' warning message will appear in the following circumstances:



OMQ4040504R

- Navigation-based Smart Cruise Control is not able to slow down your vehicle to a safe speed

*** NOTICE**

Highway Curve Zone Auto Slowdown and Set Speed Auto Change function uses the same (**AUTO**) symbol.

Highway Curve Zone Auto Slowdown

- Depending on the curve ahead on the highway (or motorway), the vehicle will decelerate, and after passing the curve, the vehicle will

accelerate to Smart Cruise Control set speed.

- Vehicle deceleration time may differ depending on the vehicle speed and the degree of the curve on the road. The higher the driving speed, deceleration will start faster.

Highway Set Speed Auto Change

- Highway Set Speed Auto Change function will operate when Smart Cruise Control set speed and the highway (or motorway) speed limit is matched.
- Whilst Highway Set Speed Auto Change function is operating, when the highway (or motorway), speed limit changes, Smart Cruise Control set speed automatically changes to the changed speed limit.
- If Smart Cruise Control set speed is adjusted different from the speed limit, Highway Set Speed Auto Change function will be in the standby state.
- If Highway Set Speed Auto Change function has changed to the standby state by driving on a road other than the highway (or motorway) main road, Highway Set Speed Auto Change function will operate again when you drive on the main road again without setting the set speed.

- If Highway Set Speed Auto Change function has changed to the standby state by depressing the brake pedal, press the (|| ⤵) switch to restart the function.
- Highway Set Speed Auto Change function does not operate on highway interchanges or junctions.

*** NOTICE**

- Highway Set Speed Auto Change function only operates based on the speed limits of the highway (or motorway), it does not work with the speed cameras.
- When Highway Set Speed Auto Change function is operating, the vehicle automatically accelerates or decelerates when the highway (or motorway) speed limit changes.
- When Highway Set Speed Auto Change function is operating, the vehicle may warn the driver when the vehicle's set speed limit is above the speed camera limit.
- The maximum set speed for Highway Set Speed Auto Change function is 90 mph (140 km/h).
- If the speed limit of a new road is not updated in the navigation, Highway Set Speed Auto Change function may not operate properly.
- If the speed unit is set to a unit other than the speed unit used in

your country, Highway Set Speed Auto Change function may not operate properly.

Limitations

Navigation-based Smart Cruise Control may not operate normally under the following circumstances:

- The navigation is not working properly
- Speed limit and road information in the navigation is not updated
- The map information and the actual road is different because of real-time GPS data or map information error
- The navigation searches for a route whilst driving
- GPS signals are blocked in areas such as a tunnel
- The navigation is being updated whilst driving
- Map information is not transmitted due to infotainment system's abnormal operation
- A road that divides into two or more roads and joins again
- The driver goes off course the route set in the navigation
- The route to the destination is changed or cancelled by resetting the navigation
- The vehicle enters a service station or rest area
- The speed limit of some sections changes according to the road situations

- Android Auto or Car Play is operating
- The navigation cannot detect the current vehicle position (ex: elevated roads including overpass adjacent to general roads or nearby roads exist in a parallel way)
- The navigation is being restarted whilst driving
- There is bad weather, such as heavy rain, heavy snow, etc.
- Driving on a road under construction
- Driving on a road that is controlled
- Driving on a road that is sharply curved
- Driving on roads with intersections, roundabouts, straight entrances and exits, etc.

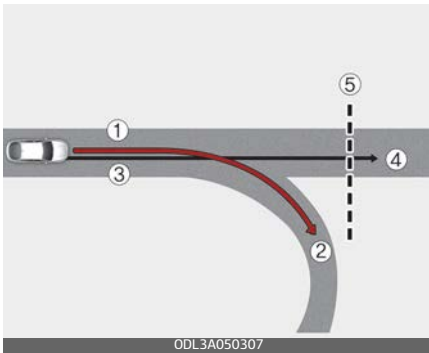

[1]: Set route, [2]: Branch line, [3]: Driving route, [4]: Main road, [5]: Curved road section

- When there is a difference between the navigation set route (branch line) and the driving route (main road), Highway Curve Zone

Auto Slowdown function may not operate until the driving route is recognised as the main road.

- When the vehicle's driving route is recognised as the main road by maintaining the main road instead of the navigation set route, Highway Curve Zone Auto Slowdown function will operate. Depending on the distance to the curve and the current vehicle speed, vehicle deceleration may not be sufficient or may decelerate rapidly.

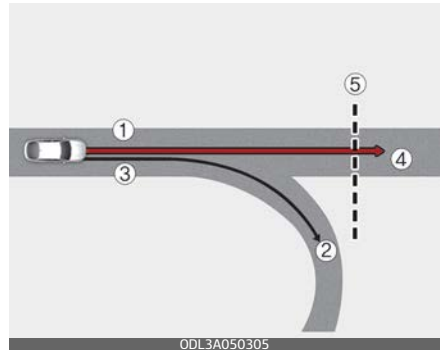

[1]: Main road, [2]: Branch line, [3]: Driving route, [4]: Set route, [5]: Curved road section

- When there is a difference between the navigation route (main road) and the driving route (branch line), Highway Curve Zone Auto Slowdown function will operate based on the curve information on the main road.
- When it is judged that you are driving out of the route by entering the highway interchange or junction, Highway Curve Zone

Auto Slowdown function will not operate.

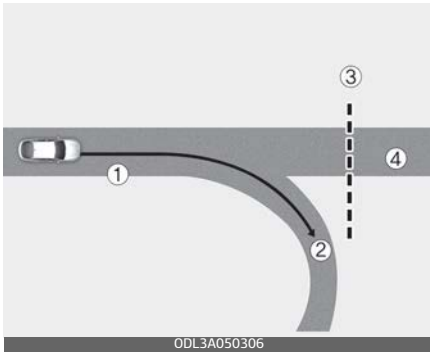

[1]: Driving route, [2]: Branch line, [3]: Curved road section, [4]: Main road

- If there is no destination set on the navigation, Highway Curve Zone Auto Slowdown function will operate based on the curve information on the main road.
- Even if you depart from the main road, Highway Curve Zone Auto Slowdown function may temporarily operate due to navigation information of the highway curve section.

⚠ WARNING

- Navigation-based Smart Cruise Control is not a substitute for safe driving practices, but a convenience function. Always have your eyes on the road, and it is the responsibility of the driver to avoid violating traffic laws.
- The navigation's speed limit information may differ from the

actual speed limit information on the road. It is the driver's responsibility to check the speed limit on the actual driving road or lane.

- Navigation-based Smart Cruise Control may not operate due to the existence of leading vehicles and the driving conditions of the vehicle. Always pay attention to road and driving conditions whilst driving.
- When you are towing a trailer or another vehicle, we recommend that Navigation-based Smart Cruise Control is turned off due to safety reasons.
- After you pass through a tollgate on a highway (or motorway), Navigation-based Smart Cruise Control will operate based on the first lane. If you enter one of the other lanes, the function might not operate properly.
- The vehicle will accelerate if the driver depresses the accelerator pedal whilst Navigation-based Smart Cruise Control is operating, and the function will not decelerate the vehicle.
- If the driver accelerates and releases the accelerator pedal whilst Navigation-based Smart Cruise Control is operating, the vehicle may not decelerate sufficiently or may rapidly decelerate to a safe speed.

- If the curve is too large or too small, Navigation-based Smart Cruise Control may not operate.

* NOTICE

- The speed information on the cluster and navigation may differ.
- The time gap could occur between the navigation's guidance and when Navigation-based Smart Cruise Control operation starts and ends.
- Even if you are driving at a speed lower than Smart Cruise Control set speed, acceleration may be limited by the curve sections ahead.
- If Navigation-based Smart Cruise Control is operating whilst leaving the main road to enter an interchange, junction, rest area, etc., the function may operate for a certain period of time.
- Deceleration by Navigation-based Smart Cruise Control may feel it is not sufficient due to road conditions such as uneven road surfaces, narrow lanes, etc.

Lane Following Assist (LFA)

Lane Following Assist is designed to help detect lane markings and/or vehicles on the road, and assists the driver's steering to help keep the vehicle between lanes.

Detecting sensor

Front view camera



The front view camera is used as a detecting sensor to detect lane markings and front vehicles.

Refer to the picture above for the detailed location of the detecting sensor.

⚠ CAUTION

For more details on the precautions of the front view camera, refer to "Forward Collision-Avoidance Assist (FCA) (Sensor fusion) (if equipped)" on page 6-78.

Function settings

Setting

Turning On/Off (Lane Driving Assist button)

[Except Europe/Australia]



With the ENGINE START/STOP button in the ON position, press the Lane Safety button located on the instrument panel to turn on Lane Keeping Assist. The white (🚗) indicator light will illuminate on the cluster.

* NOTICE

- When Lane Keeping Assist is turned off with the Lane Safety button, Lane Safety settings will turn off.

Warning volume



With the ENGINE START/STOP button in the ON position, select 'Driver Assistance → Warning Volume' from the Settings menu to change the Warning Volume to 'High', 'Medium', 'Low' or 'Off' for Hands-off warning.

However, even if 'Off' is selected, the function's Warning Volume will not turn off but the volume will sound as 'Low'.

If you change the Warning Volume, the Warning Volume of other Driver Assistance systems may change.

Lane Following Assist Operation

Warning and control

Lane Following Assist



If the vehicle ahead and/or both lane markings are detected and your vehicle speed is below 200 km/h (120 mph), the green (🚗) indicator light will illuminate on the cluster, and the function will help the vehicle stay in lane by assisting the steering wheel.

⚠ CAUTION

When the steering wheel is not assisted, the green (🚗) indicator light will blink and change to white.

Hands-off warning



If the driver takes their hands off the steering wheel for several seconds, the 'Keep hands on the steering wheel' warning message will appear and an audible warning will sound in stages.

First stage: Warning message

Second stage: Warning message (red steering wheel) and audible warning



If the driver still does not have their hands on the steering wheel after the hands-off warning, the 'LFA (Lane Following Assist) cancelled'

warning message will appear and Lane Following Assist will be automatically cancelled.

⚠ WARNING

- If you attach objects to the steering wheel or certain amount of power is put to the steering wheel, the Lane Following Assist may not assist.
- Lane Following Assist does not operate at all times. It is the responsibility of the driver to safely steer the vehicle and to maintain the vehicle in its lane.
- The hands-off warning message may appear late depending on road conditions. Always have your hands on the steering wheel whilst driving.
- If the steering wheel is held very lightly the hands-off warning message may appear because the function may not recognise that the driver has their hands on the steering wheel.
- If you attach objects to the steering wheel, the hands-off warning may not work properly.

*** NOTICE**

- For more details on setting the functions in the infotainment system, refer to the infotainment system manual.

- When both lane markings are detected, the lane lines on the cluster will change from grey to white.

Lane undetected



Lane detected



- If lane markings are not detected, steering wheel control by Lane Following Assist can be limited depending on whether a vehicle is in front or the driving conditions of the vehicle.
- Even though the steering is assisted by Lane Following Assist, the driver may control the steering wheel.

- The steering wheel may feel heavier or lighter when the steering wheel is assisted by Lane Following Assist than when it is not.

Lane Following Assist Malfunction and Limitations

Lane Following Assist malfunction



OMQ4050157R

When Lane Following Assist is not working properly, the 'Check LFA (Lane Following Assist) system' warning message will appear on the cluster. If this occurs, have the function be inspected by an authorised Kia dealer.

Limitations of Lane Following Assist

For more details on function limitations, refer to "Lane Keeping Assist (LKA) (if equipped)" on page 6-94.

Highway Driving Assist (HDA) (if equipped)

Basic function

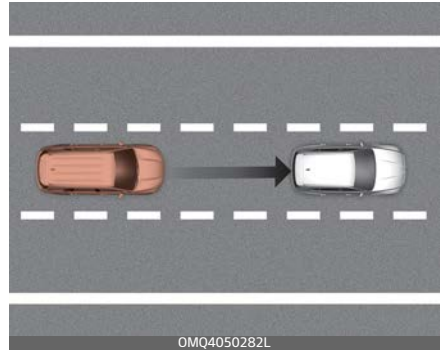

OMQ4050282L

Highway Driving Assist is designed to help detect vehicles and lanes ahead, and help maintain distance from the vehicle ahead, maintain the set speed, and keep the vehicle between lanes whilst driving on the highway (or motorway).

Detecting sensor

Front view camera



OMQ4H051009

Front radar



Refer to the picture above for the detailed location of the detecting sensors.

CAUTION

For more details on the precautions of the detecting sensors, refer to "Forward Collision-Avoidance Assist (FCA) (Sensor fusion) (if equipped)" on page 6-78.

Highway Driving Assist Settings

Setting

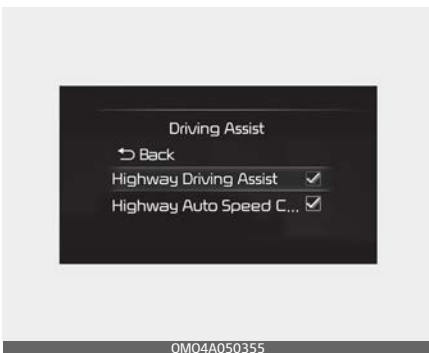

With the ENGINE START/STOP button in the ON position, select or deselect 'Driver Assistance → Driving Assist' from the Settings menu to set whether or not to use each function.

- If 'Highway Driving Assist' is selected, it helps maintain distance from the vehicle ahead, maintain the set speed, and keep the vehicle between lanes.

*** NOTICE**

- If there is a problem with the functions, the settings cannot be changed. Have the function be inspected by an authorised Kia dealer.
- If the engine is restarted, the functions will maintain the last setting.

WARNING

For your safety, change the Settings after parking the vehicle at a safe location.

Warning volume



With the ENGINE START/STOP button in the ON position, select 'Driver Assistance → Warning Volume' from the Settings menu to change the Warning Volume to 'High', 'Medium', 'Low' or 'Off' for Highway Driving Assist.

However, even if 'Off' is selected, the function's Warning Volume will not turn off but the volume will sound as 'Low'.

If you change the Warning Volume, the Warning Volume of other Driver Assistance systems may change.

Highway Driving Assist Operation Function operation

Display and control

You can see the status of the Highway Driving Assist operation in the Driving Assist view on the cluster. Refer to "LCD display" on page 5-80.

Highway Driving Assist will be displayed as below depending on the status of the function.

Operating State

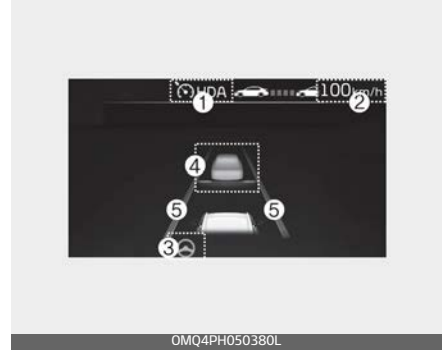

Standby State



1. Highway Driving Assist indicator, whether there is a vehicle ahead and the selected distance level are displayed.
 - Highway Driving Assist indicator
 - Green (HDA): Operating state
 - White (HDA): Standby state
2. Set speed is displayed.
3. Lane Following Assist indicator displayed.

- 4. Whether there is a vehicle ahead and the target vehicle to vehicle distance are displayed.
- 5. Whether the lane is detected or not is displayed.

- * For more details on Lane Following Assist (LFA), refer to "Lane Following Assist (LFA)" on page 6-169.
- * For more details on Smart Cruise Control (SCC), refer to "Smart Cruise Control (SCC) (if equipped)" on page 6-146.

Depending on the instrument panel specifications or theme, images or colours may be displayed differently.

Function operating

Highway Driving Assist will operate when entering or driving on the main road of highways (or motorways), and satisfying all the following conditions:

- Lane Following Assist is operating
- Smart Cruise Control is operating

*** NOTICE**

- Whilst driving on the highway (or motorway), if Smart Cruise Control starts operating, Highway Driving Assist will operate.
- When entering the main roads of highways (or motorways), Highway Driving Assist will not turn on if the Lane Following Assist is

turned off even when Smart Cruise Control is operating.

Restarting after stopping



When Highway Driving Assist is operating, your vehicle will stop if the vehicle ahead of you stops. Also, if the vehicle ahead of you starts moving approximately within 30 seconds after the stop, your vehicle will start as well. In addition, after the vehicle has stopped and approximately 30 seconds have passed, the 'Leading vehicle is driving on' message will appear on the cluster. Depress the accelerator pedal or push the + switch, - switch or (||↻) switch to start driving.

Hands-off warning



OMQ4051155R

If the driver takes their hands off the steering wheel for several seconds, the 'Keep hands on steering wheel' warning message will appear and an audible warning will sound in stages.

- First stage: Warning message
- Second stage: Warning message (red steering wheel) and audible warning



OMQ4051219R

If the driver still does not have their hands on the steering wheel after the hands-off warning, the 'HDA (Motorway Driving Assist) sys. cancelled' warning message will appear.

Function standby

When the Smart Cruise Control is temporarily cancelled whilst Highway Driving Assist is operating, Highway Driving Assist will be in the standby state. At this time, Lane Following Assist will operate normally.

Highway Driving Assist Malfunction and Limitations

Highway Driving Assist malfunction



OMQ4050220R

When Highway Driving Assist is not working properly, the 'Check HDA (Motorway Driving Assist) system' warning message will appear, and the (⚠) warning light will illuminate on the cluster. Have the function be inspected by an authorised Kia dealer.

⚠ WARNING

- The driver is responsible for controlling the vehicle for safe driving.
- Always have your hands on the steering wheel whilst driving.
- Highway Driving Assist is a supplemental function that assists the driver in driving the vehicle and is not a complete autonomous driving system. Always check road conditions, and if necessary, take appropriate actions to drive safely.
- Always have your eyes on the road, and it is the responsibility of the driver to avoid violating traffic laws. The vehicle manufacturer is not responsible for any traffic violation or accidents caused by the driver.
- Highway Driving Assist may not be able to recognise all traffic situations. The function may not detect possible collisions due to Limitations. Always be aware of the Limitations. Obstacles such as vehicles, motorcycles, bicycles, pedestrians, guardrails, tollgate, unspecified objects, structures, etc. that may collide with the vehicle may not be detected.
- Highway Driving Assist will turn off automatically under the following situations:
 - Driving on roads that the function does not operate, such as a rest area, intersection, junction, etc.
 - The navigation does not operate properly such as when the navigation is being updated or restarted
- Highway Driving Assist may inadvertently operate or turn off depending on road conditions (navigation information) and surroundings.
- Lane Following Assist function may be temporarily disabled when the front view camera cannot detect lanes properly or the hands-off warning is on.
- You may not hear the warning sound of Highway Driving Assist if the surrounding is noisy.
- If the vehicle is driven at high speed above a certain speed at a curve, your vehicle may drive to one side or may depart from the driving lane.
- When you are towing a trailer or another vehicle, we recommend that Highway Driving Assist is turned off due to safety reasons.

- The hands-off warning message may appear early or late depending on how the steering wheel is held or road conditions. Always have your hands on the steering wheel whilst driving.
- For your safety, please read the owner's manual before using the Highway Driving Assist.
- Highway Driving Assist will not operate when the engine is started, or when the detecting sensors or navigation is being initialised.
- The driver goes off course or the route to the destination is changed or cancelled by resetting the navigation (including TPEG change)
- The vehicle enters a service station or rest area
- Android Auto or Car Play is operating
- The navigation cannot detect the current vehicle position (ex: elevated roads including overpass adjacent to general roads or nearby roads exist in a parallel way)

Limitations

Highway Driving Assist and Highway Lane Change function may not operate normally, or may not operate under the following circumstances:

- The map information and the actual road is different because the navigation is not updated
- The map information and the actual road is different because of real-time GPS data or map information error
- The infotainment system is overloaded by simultaneously performing functions such as route search, video playback, voice recognition, etc.
- GPS signals are blocked in areas such as a tunnel

⚠ CAUTION

For more details on the limitations of the front view camera and front radar, refer to "Forward Collision-Avoidance Assist (FCA) (Sensor fusion) (if equipped)" on page 6-78.

Rear Cross-Traffic Collision-Avoidance Assist (RCCA) (if equipped)

Rear Cross-Traffic Collision-Avoidance Assist is designed to help detect vehicles approaching from the left and right side whilst your vehicle is reversing, and warn the driver that a collision is imminent with a warning message and an audible warning. Also, braking is assisted to help prevent collision.

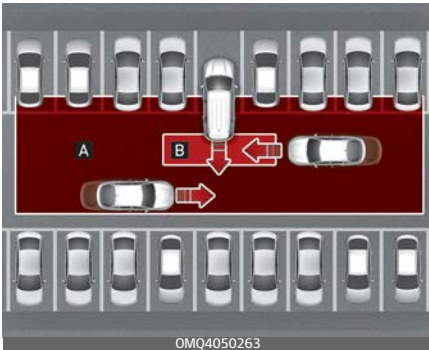

[A]: Rear Cross-Traffic Collision Warning operating area

[B]: Rear Cross-Traffic Collision-Avoidance Assist operating area

⚠ CAUTION

The time of warning may vary depending on vehicle speed of the approaching vehicle.

* NOTICE

In the following text, Rear Cross-Traffic Collision Assist will be referred as Rear Cross-Traffic Safety system.

Detecting sensor

Rear corner radar



Refer to the picture above for the detailed location of the detecting sensor.

⚠ CAUTION

For more details on the precautions of the rear corner radar, refer to "Blind-Spot Collision-Avoidance Assist (BCA) (if equipped)" on page 6-101.

Rear Cross-Traffic Collision-Avoidance Assist Settings

Setting

Rear Cross-Traffic Safety



With the ENGINE START/STOP button in the ON position, select 'Driver Assistance → Parking Safety → Rear Cross-Traffic Safety' from the Settings menu to turn on Rear Cross-Traffic Safety system and deselect to turn off the function.

WARNING

When the engine is restarted, Rear Cross-Traffic Safety system will always turn on. However, if 'Off' is selected after the engine is restarted, the driver should always be aware of the surroundings and drive safely.

* NOTICE

Settings for Rear Cross-Traffic Safety system include Rear Cross-Traffic Collision Warning and Rear Cross-Traffic Collision-Avoidance Assist.

Warning timing



With the ENGINE START/STOP button in the ON position, select 'Driver Assistance → Warning Timing' from the Settings menu to change the initial warning activation time for Rear Cross-Traffic Safety system.

When the vehicle is first delivered, Warning Timing is set to 'Normal'. If you change the Warning Timing, the warning time of other Driver Assistance systems may change.

Warning volume



With the ENGINE START/STOP button in the ON position, select 'Driver Assistance → Warning Volume' from the Settings menu to change the Warning Volume to 'High', 'Medium', 'Low' or 'Off' for Rear Cross-Traffic Safety system.

However, even if 'Off' is selected, the function's Warning Volume will not turn off but the volume will sound as 'Low'.

If you change the Warning Volume, the Warning Volume of other Driver Assistance systems may change.

⚠ CAUTION

- The setting of the Warning Timing and Warning Volume applies to all functions of the Rear Collision-Avoidance Assist.
- Even though 'Normal' is selected for Warning Timing, if the vehicles from the left and right side approaches at high speed, the ini-

tial warning activation time may seem late.

- Select 'Late' for Warning Timing when traffic is light and when driving speed is slow.

* NOTICE

If the engine is restarted, Warning Timing and Warning Volume will maintain the last setting.

Rear Cross-Traffic Collision-Avoidance Assist Operation

Warning and control

Rear Cross-Traffic Safety system will warn and control the vehicle depending on collision level: 'Collision Warning', 'Emergency Braking' and 'Stopping vehicle and ending brake control'.

Collision warning



Driving your vehicle



- To warn the driver of an approaching vehicle from the rear left/right side of your vehicle, the warning light on the side view mirror will blink and a warning will appear on the cluster. At the same time, an audible warning will sound. If the Rear View Monitor is operating, a warning will also appear on the infotainment system screen.
- The function will operate when all the following conditions are satisfied:
 - The gear is changed to R (Reverse)

Rear Cross-Traffic Collision-Avoidance Assist (RCCA)

- Vehicle speed is below 8 km/h (5 mph)
- The approaching vehicle is within approximately 25 m (82 ft.) from the left and right side of your vehicle
- The speed of the vehicle approaching from the left and right is above 5 km/h (3 mph)

* NOTICE

If the operating conditions are satisfied, there will be a warning whenever the vehicle approaches from the left or right side even though your vehicle speed is 0 km/h (0 mph).

Emergency braking





- To warn the driver of an approaching vehicle from the rear left/right side of your vehicle, the warning light on the side view mirror will blink and a warning message will appear on the cluster. At the same time, an audible warning will sound. If the Rear View Monitor is operating, a warning will also appear on the infotainment system screen.

- The function will operate when all the following conditions are satisfied:
 - The gear is changed to R (Reverse)
 - Vehicle speed is below 8 km/h (5 mph)
 - The approaching vehicle is within approximately 1.5 m (5 ft.) from the left and right side of your vehicle
 - The speed of the vehicle approaching from the left and right is above 5 km/h (3 mph)
- Emergency braking will be assisted to help prevent collision with approaching vehicles from the left and right.

⚠ WARNING

Brake control will end when:

- The approaching vehicle is out of the detecting range
- The approaching vehicle passes behind your vehicle
- The approaching vehicle does not drive toward your vehicle
- The approaching vehicle speed slows down
- The driver depresses the brake pedal with sufficient power

Stopping vehicle and ending brake control

OMQ4040504L

- When the vehicle is stopped due to emergency braking, the 'Drive carefully' warning message will appear on the cluster.
 - For your safety, the driver should depress the brake pedal immediately and check the surroundings.
 - Brake control will end after the vehicle is stopped by emergency braking for approximately 2 seconds.
 - During emergency braking, braking control by the function will automatically cancel when the driver excessively depresses the brake pedal.
- ⚠ WARNING**
- Take the following precautions when using Rear Cross-Traffic Safety system:
- For your safety, change the Settings after parking the vehicle at a safe location.
 - If any other function's warning message is displayed or audible warning is generated, Rear Cross-Traffic Safety function's warning message may not be displayed and audible warning may not be generated.
 - You may not hear the warning sound of Rear Cross-Traffic Safety system if the surrounding is noisy.
 - Rear Cross-Traffic Safety system may not operate if the driver applies the brake pedal to avoid collision.
 - During Rear Cross-Traffic Safety Function Operation, the vehicle may stop suddenly injuring passengers and shifting loose objects. Always have the seat belt on and keep loose objects secured.
 - Even if there is a problem with Rear Cross-Traffic Safety system, the vehicle's basic braking performance will operate normally.
 - Rear Cross-Traffic Safety system may warn the driver late or may not warn the driver depending on the road and driving conditions.
 - Rear Cross-Traffic Safety system does not operate in all situations or cannot avoid all collisions.
 - During emergency braking, braking control by the function will automatically cancel when the

driver excessively depresses the accelerator pedal.

- The driver should hold the responsibility to control the vehicle. Do not solely depend on Rear Cross-Traffic Safety system. Rather, maintain a safe braking distance, and if necessary, depress the brake pedal to reduce driving speed or to stop the vehicle.
- Never deliberately operate Rear Cross-Traffic Safety system on people, animal, objects, etc. It may cause serious injury or death.

⚠ CAUTION

The brake control may not operate properly depending on the status of ESC (Electronic Stability Control).

There will only be a warning when:

- The ESC (Electronic Stability Control) warning light is on
- ESC (Electronic Stability Control) is engaged in a different function

*** NOTICE**

- If the function assists you with braking, the driver must immediately depress the brake pedal and check vehicle surroundings.
 - Brake control will end when the driver depresses the brake pedal with sufficient power.

- After changing the gear to R (Reverse), braking control will operate once for left and right vehicle approach.

Rear Cross-Traffic Collision- Avoidance Assist Malfunction and Limitations

Rear Cross-Traffic Collision- Avoidance Assist malfunction

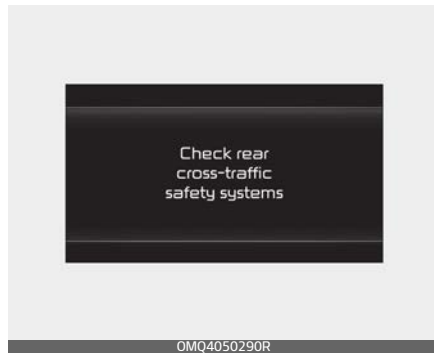

When Rear Cross-Traffic Safety system is not working properly, the 'Check Rear Cross-Traffic Safety system' warning message will appear on the cluster, and the function will turn off automatically or the function will be limited. Have the function be inspected by an authorised Kia dealer.



OMQ4050291R

When the outside mirror warning light is not working properly, the 'Check outside mirror warning icon' warning message will appear on the cluster. Have the function be inspected by an authorised Kia dealer.

Rear Cross-Traffic Collision-Avoidance Assist disabled

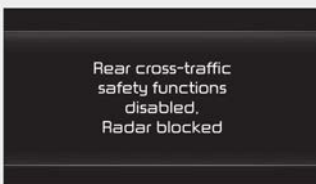

OMQ4050292R

When the rear bumper around the rear corner radar or rear sensor is covered with foreign material, such as snow or rain, or installing a trailer or carrier, it can reduce the detecting performance and temporarily

limit or disable Rear Cross-Traffic Safety system.

If this occurs, the 'Rear Cross-Traffic Safety Function disabled. Radar blocked' warning message will appear on the cluster.

The function will operate normally when such foreign material or trailer, etc. is removed.

If the function does not operate normally after it is removed, have the function be inspected by an authorised Kia dealer.

⚠ WARNING

- Even though the warning message does not appear on the cluster, Rear Cross-Traffic Safety system may not operate properly.
- Rear Cross-Traffic Safety system may not operate properly in an area (for example: open terrain), where any substance are not detected after turning ON the engine.

⚠ CAUTION

Turn off Rear Cross-Traffic Safety system to install a trailer, carrier, etc., or remove the trailer, carrier, etc. to use Rear Cross-Traffic Safety system.

Limitations

Rear Cross-Traffic Safety system may not operate normally, or the function may operate unexpectedly under the following circumstances:

- Departing from where trees or grass are overgrown
- Departing from where roads are wet
- Speed of the approaching vehicle is fast or slow

Braking control may not work, driver's attention is required in the following circumstances:

- The vehicle severely vibrates whilst driving over a bumpy road, uneven road or concrete patch
- Driving on a slippery surface due to snow, water puddle, ice, etc.
- The tyre pressure is low or a tyre is damaged
- The brake is reworked

CAUTION

For more details on the limitations of the rear corner radar, refer to "Blind-Spot Collision-Avoidance Assist (BCA) (if equipped)" on page 6-101.

WARNING

- Driving near a vehicle or structure

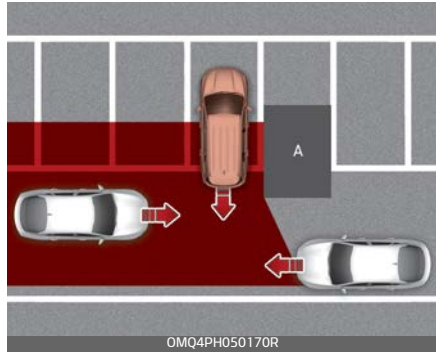

[A]: Structure

Rear Cross-Traffic Safety system may be limited when driving near a vehicle or structure, and may not detect the vehicle approaching from the left or right. If this occurs, the function may not warn the driver or control the brakes when necessary. Always check your surroundings whilst backing up.

- When the vehicle is in a complex parking environment

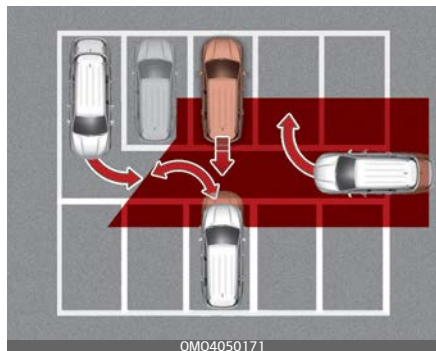

Rear Cross-Traffic Safety system may detect vehicles which are parking or pulling out near your vehicle (for example: a vehicle leaving beside your vehicle, a vehicle parking or pulling out in the rear area, a vehicle approaching your vehicle making a turn, etc.). If this occurs, the function may unnecessarily warn the driver and control the brake. Always check your surroundings whilst backing up.

- When the vehicle is parked diagonally



[A]: Vehicle

Rear Cross-Traffic Safety system may be limited when backing up diagonally, and may not detect the vehicle approaching from the left or right. If this occurs, the function may not warn the driver or control the brakes when necessary.

Always check your surroundings whilst backing up.

- When the vehicle is on or near a slope

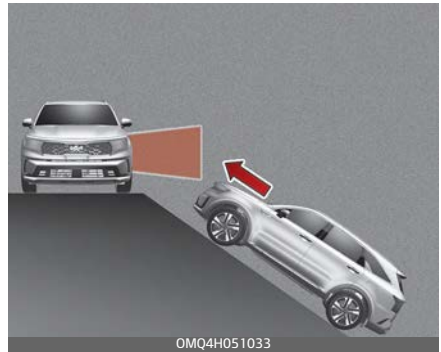

Rear Cross-Traffic Safety system may be limited when the vehicle is on a uphill or downhill slope, or near it, and may not detect the vehicle approaching from the left or right. If this occurs, the function may not warn the driver or control the brakes when necessary. Always check your surroundings whilst backing up.

⚠ WARNING

- Pulling into the parking space where there is a structure

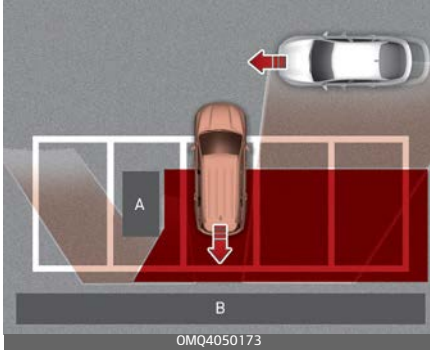

- [A]: Structure, [B]: Wall
- Rear Cross-Traffic Safety system may detect vehicles passing by in front of you when parking backwards into a parking space with a wall or structure in the rear or side area. If this occurs, the function may unnecessarily warn the driver and control the brake. Always check your surroundings whilst backing up.
- When the vehicle is parked rearward

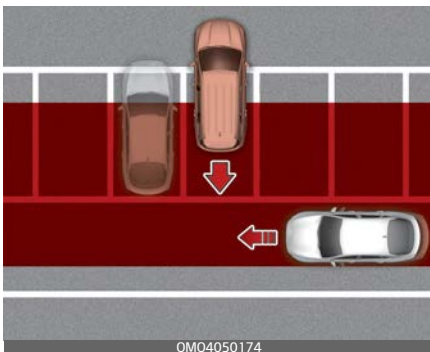

Rear Cross-Traffic Safety system may detect vehicles passing by behind you when parking backwards into a parking space. If this occurs, the function may unnecessarily warn the driver and control the brake. Always check your surroundings whilst backing up.

⚠ WARNING

- When you are towing a trailer or another vehicle, we recommend that Rear Cross-Traffic Safety system is turned off due to safety reasons.
- Rear Cross-Traffic Safety system may not operate normally if interfered by strong electromagnetic waves.
- Rear Cross-Traffic Safety system may not operate for approximately 3 seconds after the vehicle is started, or the rear corner radars are initialised.

Reverse Parking Collision-Avoidance Assist (PCA) (if equipped)

Reverse Parking Collision-Avoidance Assist may warn the driver or may assist with braking to help reduce the possibility of collision with a pedestrian or an object when backing up.

Detecting sensor

Rear view camera



Rear ultrasonic sensors



Refer to the picture above for the detailed location of the detecting sensors.

⚠ CAUTION

Take the following precautions to maintain optimal performance of the detecting sensors:

- Always keep the rear view camera and rear ultrasonic sensors clean.
- Do not use any cleanser containing acid or alkaline detergents when cleaning the rear view camera lens. Use only a mild soap or neutral detergent, and rinse thoroughly with water.
- Never disassemble or apply impact on the rear view camera or the rear ultrasonic sensors components.
- Do not apply unnecessary force on the rear view camera or the rear ultrasonic sensors. The function may not operate properly if the rear view camera or the rear ultrasonic sensor(s) is forcibly moved out of proper alignment. Have the vehicle inspected by an authorised Kia dealer.
- Do not spray the rear view camera or the rear ultrasonic sensors or their surrounding area directly with a high pressure washer. It may cause the rear view camera or the rear ultrasonic sensors to malfunction.
- The function may not work properly if the bumper has been damaged, replaced or repaired.
- Do not apply objects, such as a bumper sticker or a bumper

guard, near the rear view camera or rear ultrasonic sensors or apply paint to the bumper. Doing so may adversely affect the performance of the function.

- Reverse Parking Collision-Avoidance Assist may not operate normally if interfered by strong electromagnetic waves.

Reverse Parking Distance Warning Settings

Setting

Parking Safety

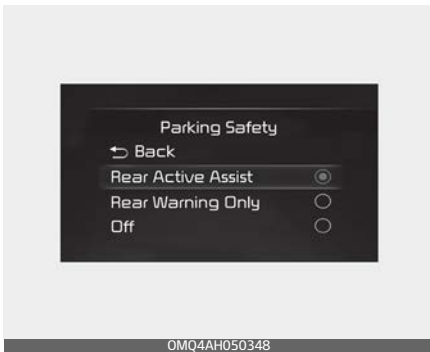

With the ENGINE START/STOP button in the ON position, select or deselect 'Driver Assistance → Parking Safety' from the Settings menu to set whether or not to use each function.

- If 'Rear Active Assist' is selected, the function will warn the driver and assist with braking when a

collision with a pedestrian or an object is imminent.

- If 'Rear Warning Only' is selected, the function will warn the driver when a collision with a pedestrian or an object is imminent. Braking will not be assisted.
- If 'Off' is selected, the function will turn off.

Warning timing



With the ENGINE START/STOP button in the ON position, select 'Driver Assistance → Warning Timing' from the Settings menu to change the initial warning activation time for Forward Collision-Avoidance Assist.

When the vehicle is first delivered, Warning Timing is set to 'Normal'.

If you change the Warning Timing, the warning time of other Driver Assistance systems may change.

Warning volume



With the ENGINE START/STOP button in the ON position, select 'Driver Assistance → Warning Volume' from the Settings menu to change the Warning Volume to 'High', 'Medium', 'Low' or 'Off' for Forward Collision-Avoidance Assist.

However, even if 'Off' is selected, the function's Warning Volume will not turn off but the volume will sound as 'Low'.

If you change the warning volume, the Warning Volume of other Driver Assistance systems may change.

Reverse Parking Distance Warning Operation

Operating conditions

If 'Rear Active Assist' or 'Rear Warning Only' is set from the Settings menu, Reverse Parking Collision-Avoidance Assist will be in the ready

status when the following conditions are satisfied:

- The liftgate is closed
- The gear is changed to R (Reverse)
- Vehicle speed is below 10 km/h (6 mph)

Function components such as the rear view camera and the rear ultrasonic sensors are in normal conditions

Rear Warning Only

- If the function detects a risk of collision with a pedestrian or an object, the function will warn the driver with an audible warning and warning message on the cluster. When Rear View Monitor is operating, a warning will appear on the infotainment system screen.
- If 'Rear Warning Only' is selected, braking will not be assisted.
- The warning will turn off when the gear is shifted to P (Park), N (Neutral) or D (Drive).

Rear Active Assist

- If the function detects a risk of collision with a pedestrian or an object, the function will warn the driver with an audible warning and warning message on the cluster. When Rear View Monitor is operating, a warning will appear on the infotainment system screen.
- If the function detects imminent collision with a pedestrian or an

object behind the vehicle, the function will assist you with braking. The driver needs to pay attention as the brake assist will end within 2 seconds. The driver must immediately depress the brake pedal and check vehicle surroundings.

- Brake control will end when:
 - The gear is changed to P (Park) or D (Drive).
 - The driver depresses the brake pedal with sufficient power
 - Braking assist last for approximately 2 seconds
- The warning will turn off when:
 - The driver changes the gear to P (Park), N (Neutral), or D (Drive)
- The brake control may not operate properly depending on the status of ESC (Electronic Stability Control).
- There will only be a warning when:
 - The ESC (Electronic Stability Control) warning light is on
 - ESC (Electronic Stability Control) is engaged in a different function

WARNING

- Playing the vehicle audio system at high volume may prevent passengers from hearing Reverse Parking Collision-Avoidance Assist warning sounds

- Noise may be heard when sudden braking occurs to avoid a collision.
- If any other warning sound such as the seat belt warning chime is already generated, Reverse Parking Collision-Avoidance Assist warning may not sound.
- The performance of Reverse Parking Collision-Avoidance Assist may vary under certain conditions. If vehicle speed is above 4 km/h (2 mph), the function will provide collision avoidance assist only when pedestrians are detected. Always look around and pay attention when backing up your vehicle.

Reverse Parking Distance Warning Malfunction and Limitations

Reverse Parking Distance Warning malfunction



When Reverse Parking Collision-Avoidance Assist or other related functions are not working properly,

Driving your vehicle

the 'Check PCA (Parking Collision Avoid. Assist)' warning message will appear on the cluster, and the function will turn off automatically. Have your vehicle inspected by an authorised Kia dealer.

Reverse Parking Distance Warning disabled



The rear view camera is used as a detecting sensor to detect pedestrians. If the camera lens is covered with foreign material, such as snow or rain, it may adversely affect camera performance and Reverse Parking Collision-Avoidance Assist may not operate normally. Always keep the camera lens clean.

Reverse Parking Collision-Avoidance Assist (PCA)



The rear ultrasonic sensors are located inside the rear bumper to detect objects in the rear area. If the sensors are covered with foreign material, such as snow or rain, it may adversely affect sensor performance and Reverse Parking Collision-Avoidance Assist may not operate normally. Always keep the rear bumper clean.

Rear view camera



Rear ultrasonic sensor



The 'Camera error or blockage' or 'Ultrasonic sensor error or blockage' warning message will appear on the cluster if the following situations occur:

- The rear view camera or ultrasonic sensors are covered with foreign material, such as snow or rain, etc.
- There is inclement weather, such as heavy snow, heavy rain, etc.

If this occurs, Reverse Parking Collision-Avoidance Assist may turn off or may not operate properly. Check whether the rear view camera and rear ultrasonic sensors are clean.

Limitations

Reverse Parking Collision-Avoidance Assist may not assist braking or warn the driver even if there are pedestrians or objects under the following circumstances:

- Any non-factory equipment or accessory is installed

- Your vehicle is unstable due to an accident or other causes
- Bumper height or rear ultrasonic sensor installation has been modified
- Rear view camera or rear ultrasonic sensor(s) is damaged
- Rear view camera or the rear ultrasonic sensor(s) is stained with foreign matter, such as snow, dirt, etc.
- Rear view camera is obscured by a light source or by inclement weather, such as heavy rain, fog, snow, etc.
- The surrounding is very bright or very dark
- Outside temperature is very high or very low
- The wind is either strong (above 12 mph (20 km/h)) or blowing perpendicular to the rear bumper
- Objects generating excessive noise, such as vehicle horns, loud motorcycle engines or truck air brakes, are near your vehicle
- An ultrasonic sensor with similar frequency is near your vehicle
- There is ground height difference between the vehicle and the pedestrian
- The image of the pedestrian in the rear view camera is indistinguishable from the background
- The pedestrian is near the rear edge of the vehicle
- The pedestrian is not standing upright

Driving your vehicle

- The pedestrian is either very short or very tall for the function to detect
- The pedestrian or cyclist is wearing clothing that easily blends into the background, making it difficult to detect
- The pedestrian is wearing clothing that does not reflect ultrasonic waves well
- Size, thickness, height, or shape of the object does not reflect ultrasonic waves well (e.g., pole, bush, kerbs, carts, edge of a wall, etc.)
- The pedestrian or the object is moving
- The pedestrian or the object is very close to the rear of the vehicle
- A wall is behind the pedestrian or the object
- The object is not located at the rear centre of your vehicle
- The object is not parallel to the rear bumper
- The road is slippery or inclined
- The driver backs up the vehicle immediately after shifting to R (Reverse)
- The driver accelerates or circles the vehicle

Reverse Parking Collision-Avoidance Assist may unnecessarily warn the driver or assist with braking even if there are no pedestrians or objects under the following circumstances:

Reverse Parking Collision-Avoidance Assist (PCA)

- Any non-factory equipment or accessory is installed
- Your vehicle is unstable due to an accident or other causes
- Bumper height or rear ultrasonic sensor installation has been modified
- Your vehicle height is low or high due to heavy loads, abnormal tyre pressure, etc.
- Rear view camera or the rear ultrasonic sensor(s) is stained with foreign matter, such as snow, dirt, etc.
- The pattern on the road is mistaken for a pedestrian
- There is shadow or light reflecting on the ground
- Pedestrians or objects are around the path of the vehicle
- Objects generating excessive noise, such as vehicle horns, loud motorcycle engines or truck air brakes, are near your vehicle
- Your vehicle is backing towards a narrow passage or parking space
- Your vehicle is backing towards an uneven road surface, such as an unpaved road, gravel, bump, gradient, etc.
- A trailer or carrier is installed on the rear of your vehicle
- An ultrasonic sensor with similar frequency is near your vehicle

Remote Smart Parking Assist (RSPA) (if equipped)

Remote Smart Parking Assist uses vehicle sensors to help the driver park and exit parking spaces remotely from outside the vehicle by automatically searching for parking spaces, and controlling the steering wheel, vehicle speed and gearshifts.

Function	Description
Remote Moving Forward/Backward	Remotely moving forward or backward 

- Remote Moving Forward/Backward function helps the driver move the vehicle forward or backward from outside the vehicle using the smart key.
- When Remote Smart Parking Assist operates, Surround View Monitor and Parking Distance Warning will also operate. For more details, refer to "Surround View Monitor (SVM) (if equipped)" on page 4-111 and "Forward/Reverse Parking Distance Warning (PDW) (if equipped)" on page 4-121.

⚠ WARNING

- The driver is responsible for safe parking and exit when using Remote Smart Parking Assist. Make sure there are no pedestrians, animals or objects around the vehicle when using the function.
- Always check surroundings when using Remote Smart Parking Assist. You may collide with pedestrians, animals, or objects if they are near the sensor or are in the sensor's blind spot area.
- A collision may occur if a pedestrian, animal, or object suddenly appears whilst Remote Smart Parking Assist is operating.
- Do not use Remote Smart Parking Assist when under the influence of alcohol.
- Do not let children or other people to use the smart key.
- When operating Remote Smart Parking Assist, be careful of objects such as flower pots or parking blocks located above or below the ultrasonic sensor. Such object may damage the vehicle or other objects.

⚠ CAUTION

- Remote Smart Parking Assist may not operate properly depending on the surroundings and other conditions.

- If the Remote Smart Parking Assist is used continuously for a long period, it may adversely affect function performance.
- Remote Smart Parking Assist may not operate normally if the vehicle needs wheel alignment adjustment such as when the vehicle tilts to one side. We recommend that the vehicle be checked by an authorised Kia dealer/service partner.
- If you use a different tyre or wheel size rather than the size recommended, it may adversely affect Remote Smart Parking Assist performance.
- Remote Smart Parking Assist performance may reduce on uneven surfaces (curbstone, speed bump, etc.).
- If you attach objects or install any types of cover on the steering wheel, it may cancel Remote Smart Parking Assist operation.
- Noise may be heard when braking occurs by Remote Smart Parking Assist or when the brake pedal is depressed by the driver.
- Remote Smart Parking Assist may suddenly apply the brake to avoid collision.
- Use the function only in a parking space that is large enough for the vehicle to move safely.

* NOTICE

- If the 3rd stage warning (continuous beep) of the Forward/Reverse Parking Distance Warning sounds whilst Remote Smart Parking Assist is operating, it means the obstacle detected is close to your vehicle. At this time, Remote Smart Parking Assist will temporarily stop operating. Make sure there are no pedestrians, animals, or objects around your vehicle.
- Depending on brake operation, the stop lights may come on whilst the vehicle is moving.

Detecting sensor

Front ultrasonic sensors



Front corner ultrasonic sensors



Rear corner ultrasonic sensors



Rear ultrasonic sensors



Refer to the picture above for the detailed location of the detecting sensors.

⚠ CAUTION

Take the following precautions to maintain optimal performance of the detecting sensors:

- Never disassemble the detecting sensor or sensor assembly, or apply any impact on it.
- If the detecting sensor have been replaced or repaired, we recommend that you have your vehicle inspected by an authorised Kia dealer/service partner.
- Remote Smart Parking Assist may not operate normally when:
 - Moisture is frozen to the sensor
 - Sensor is covered with foreign material, such as snow or waterThe function will operate normally when such foreign material are removed.
- Remote Smart Parking Assist may malfunction when:
 - Driving on uneven road, gravel roads or bushes
 - Objects that generates ultra-sonic waves such as vehicle horns, loud motorcycle engine sound or truck air brakes are near the sensor
 - Heavy rain or water spray is present
 - Wireless transmitters or mobile phones are present near the sensor
 - The sensor is covered with snow

- Affected by another vehicle's sensors
 - Water flows on the surface of the sensor
 - Installing the license plate differently from the original location
 - Detecting range may decrease when:
 - Sensor is covered with foreign matters, such as snow or water (The function will operate normally when such foreign material are removed.)
 - The weather is extremely hot or cold
 - The following objects may not be detected:
 - Sharp or slim objects, such as ropes, chains or small poles.
 - Objects which tend to absorb sensor frequency, such as clothes, spongy material or snow.
 - Objects smaller than 100 cm (40 in.) in length and narrower than 14 cm (6 in.) in diameter.
-

Remote Smart Parking Assist Settings

Setting

Warning volume

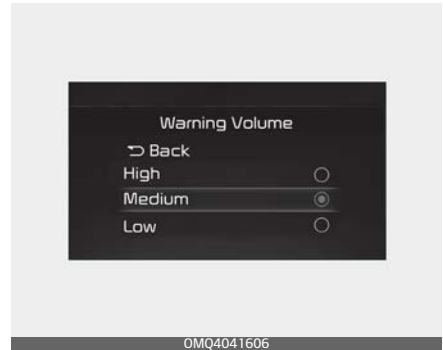





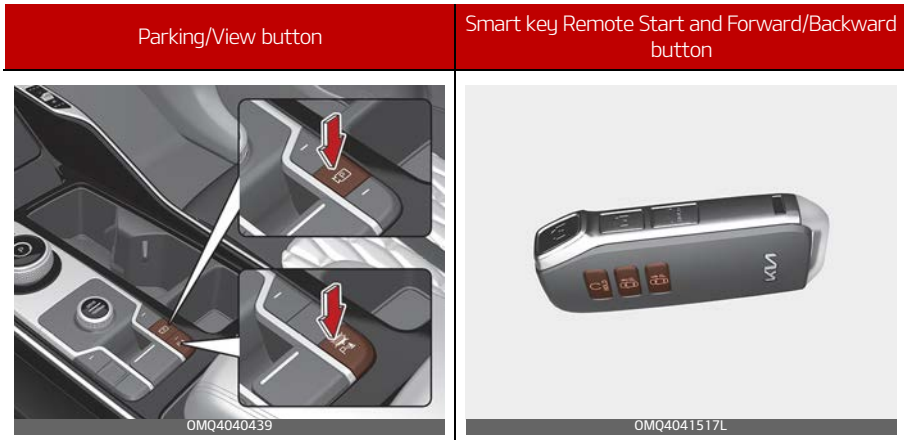

With the ENGINE START/STOP button in the ON position, select 'Driver Assistance → Warning Volume' from the Settings menu to change the Warning Volume to 'High', 'Medium', 'Low' or 'Off' for Remote Smart Parking Assist.

However, even if 'Off' is selected, the function's Warning Volume will not turn off but the volume will sound as 'Low'.

If you change the warning volume, the Warning Volume of other Driver Assistance systems may change.

Remote Smart Parking button



Location	Name	Symbol	Description
Inside vehicle	Parking/View button		Press and hold the Parking/View button to turn on Remote Smart Parking Assist. Also, Forward/Reverse Parking Distance warning will automatically turn on. However, functions may differ depending on the situations. Refer to each function's description for more details in the following pages.
	Parking Safety button		Press the Parking Safety button whilst Remote Smart Parking Assist is operating to end function operation.
Smart Key	Remote Start button		Press the Remote Start button after the door is locked with the engine off to start the engine remotely. Press the Remote Start button whilst Remote Moving Forward/Reverse function is operating to end function operation.
	Forward button		When using Remote Smart Parking function, regardless of which direction button is pressed, reverse parking is supported whilst the button is pressed.
	Backward button		When using the Remote Moving Forward/Backward function, the vehicle moves in the direction of the button whilst the button is pressed.

Remote Smart Parking Assist Operation

Remote Moving Forward/Backward

1. Getting ready to remotely move forward and backward

There are two ways to operate Remote Moving Forward/Backward function.

Method (1): Using the function with engine off



1. Within a certain range from the vehicle press the door lock (🔒) button on the smart key and lock all doors.
2. Press and hold the Remote Start button (🔴Ⓜ️) within 4 seconds until the engine starts.

Method (2): Using the function with engine on



1. Park the vehicle in front of the space where you want to use Remote Moving Forward/Backward function, and shift the gear to P (Park).
2. Press and hold the Parking/View (🔴Ⓜ️) button to turn on Smart Parking Assist. A message 'Under Remote Control' will appear on the infotainment system screen.
3. Get out of the vehicle with the smart key and close all doors.

- The infotainment system has to operate properly to use Remote Moving Forward/Backward function.
- Drive below 5 km/h (3 mph) with the engine on to use Remote Moving Forward/Backward function.
- If the function is turned on again after parallel parking is completed by Remote Smart Parking Assist, Remote Moving Forward/Backward function can be used.
- Check that all smart keys are outside the vehicle when using Remote Moving Forward/Backward function.

2. Remote Moving Forward/Backward







1. Press and hold one of the Forward (⏪) or Backward (⏩) button on the smart key. Remote Smart Parking Assist will automatically control the steering wheel, vehicle speed and gearshift. The vehicle



- will move in the direction of the button pressed.
 2. Whilst Remote Moving Forward/Backward function is operating, if the you do not hold down the Forward (⏪) or Backward (⏩) button, the vehicle will stop and function control will pause. The function will start operating again when the button is pressed and held again.
 3. When the vehicle reaches the target location, the function will turn off.
 4. When the driver gets on the vehicle with the smart key, a message will appear informing the driver Remote Moving Forward/Backward function is complete on the infotainment system screen. In addition, when the Remote Start (HOLD) button is pressed on the smart key, a message will appear informing the driver Remote Moving Forward/Backward function is complete and the engine will turn off.
- Remote Moving Forward/Backward function will operate only when the smart key is within 4 m (13 ft.) from the vehicle. If there is no vehicle movement even when the Forward or Backward button is pressed on the smart key, check the distance to the vehicle and press the button again.

- The detecting range of the smart key may vary depending on the surroundings that are affected by radio waves such as transmission tower, broadcast station, etc.
 - When remotely moving forward using method (1), it is recognised as an exit situation, and the vehicle moves 4 m (13 ft.) to check for pedestrians, animals or objects around the vehicle. After confirmation, the steering wheel is controlled according to the condition ahead.
 - When remotely moving forward using method (2), it is recognised as a parking situation, and will immediately control the steering wheel according to the condition ahead to assist with entering the parking space and aligning the vehicle. However, performance may reduce depending on the pedestrians, animals, shape of objects, location, etc. around the vehicle.
 - For moving remotely backward, both method (1) and (2) aligns the steering wheel first, and then will only move the vehicle straight.
 - When remotely moving forward or backward is completed, the vehicle will automatically shift to P (Park) and engage EPB (Electronic Parking Brake).
- ⚠ CAUTION**
- When using Remote Moving Forward/Backward function, make sure that all passengers have gotten out of the vehicle.
 - Before leaving the vehicle, close windows and sunroofs, and make sure the engine is off before locking the doors.
 - If the vehicle's battery is discharged or Remote Smart Parking Assist malfunctions when parked in a narrow parking space, Remote Moving Forward/Backward function will not operate. Always park your vehicle in a space wide enough for you to get in or out of your vehicle.
 - Please note that depending on the parking space, you may not be able to exit from the space you have entered by using Remote Moving Forward/Backward function.
 - After parking, the surrounding may change due to the movement of surrounding vehicles. If this occurs, Remote Moving Forward/Backward function may not operate.
-

How to turn off Remote Moving Forward/Backward function whilst operating

- Press the Remote Start () button on the smart key.
- Press the Parking/View () button.
- Press the Parking Safety () button or select 'Cancel' on the infotainment system screen.
- Press the Remote Start () button on the smart key. Remote Moving Forward/Backward function will turn off. At this time, the engine will turn off.
- Get on the vehicle with the smart key. Remote Moving Forward/Backward function will turn off. At this time, the engine will remain on.

The function will pause in the following conditions when:

- There is a pedestrian, animal or object in the direction the vehicle is moving
- The door or tailgate is open
- The Forward () or Backward () button is not continuously pressed
- Simultaneously pressing multiple buttons on a smart key
- The smart key is not operated within 4 m (13 ft.) from the vehicle

- Button of another smart key is pressed in addition to the operating smart key
- Blind-Spot Collision-Avoidance Assist or Rear-Cross Traffic Collision Assist operates whilst the vehicle is being controlled in the reverse direction
- The vehicle moves 7 m (22 ft.) whilst the smart key is pressed with Remote Moving Forward/Backward function (maximum travel distance per button press)

When Remote Moving Forward/Backward function is paused, the vehicle will stop. If the condition that made the function to pause disappears, the function may operate again.

The function will cancel in the following conditions when:

- The steering wheel is steered
- The gear is shifted whilst the vehicle is moving
- Operating EPB whilst the vehicle is moving
- The engine bonnet is open
- Vehicle speed is above 5 km/h (3 mph)
- Rapid acceleration occurs
- Vehicle skid occurs
- The wheel is stuck by an obstacle and cannot move
- There are pedestrians, animals or objects at the front and rear of the vehicle at the same time

- Approximately 3 minutes and 50 seconds have past after Remote Moving Forward/Backward function has started to operate
- The slope of the road exceeds the operational range
- The steering wheel, gearshift, braking, and drive controls are not working normally
- The function is paused for more than 1 minute
- The total travel distance of the vehicle has exceeded 14 m (45 ft.) after Remote Moving Forward/Backward function operation
- There is a problem with the smart key or the smart key battery is low
- ABS, TCS or ESC operates due to slippery road conditions
- The brake pedal or accelerator pedal is depressed when all the doors are closed
- The smart key is outside the vehicle when the brake pedal is depressed whilst the driver's door is open.
- The alarm of the Theft Alarm System sounds

When Remote Moving Forward/Backward function is cancelled, the vehicle will automatically stop, shift the gear to P (Park) and engage EPB (Electronic Parking Brake).

CAUTION

Check whether the doors are locked when Remote Moving Forward/Backward function is cancelled.

Remote Smart Parking Assist operation status

Smart key LED/Hazard warning light

The operation status of Remote Smart Parking Assist is indicated by the smart key LED and the hazard warning light.

Operation Status	Smart Key LED		Hazard warning light
Remote Moving Forward/Backward in operation		Green LED Continuously blinks	-
Remote Moving Forward/Backward paused		Red LED Continuously blinks	Blinks
Remote Moving Forward/Backward operation off		Red LED illuminates for 4 seconds and then turns off	Blinks 3 times and turns off
Remote Moving Forward/Backward operation complete		Green LED illuminates for 4 seconds and then turns off	Blinks 1 time and turns off

* Operation status by the hazard warning light may not be applicable based on the regulation of your country.

* If the smart key is not within the operating range from the vehicle (approximately 4 m (13 ft.)), the smart key LED will not illuminate or blink. Use the smart key within the operating range.

Remote Smart Parking Assist Malfunction and limitations

Remote Smart Parking Assist Malfunction

Remote Smart Parking Assist check



OMQ4050313L

When Remote Smart Parking Assist is not working properly, the 'Check Parking Assist' warning message will appear on the infotainment system screen. If the message appears, stop using the function, and we recommend that the function be inspected by an authorised Kia dealer/service partner.

Remote Smart Parking Assist cancelled



OMQ4051315L

When Remote Smart Parking Assist is operating, the function can be cancelled, and the warning message may appear regardless of the parking order. Other messages may appear depending on the situations. Follow the instructions provided on the infotainment system screen whilst parking your vehicle with Remote Smart Parking Assist. Always look around and pay attention when using the function.

Remote Smart Parking Assist standby



When 'Parking Assist Conditions Not Met' message appears, when Parking/View (P) button has been pressed and held, Remote Smart Parking Assist is in standby. After a whilst, press and hold the Parking/View (P) button again to see if the function works.

The message appears even when the smart key's battery is low. Check the smart key battery level.

Limitations of Remote Smart Parking Assist

In the following circumstances, function performance to park or exit the vehicle may be limited, there may be a risk of collision, or Remote Smart Parking Assist may turn off. Park or exit the vehicle manually if necessary.

- The parking space is curved or diagonal
- There is an obstacle such as a trash can, bicycle, motorcycle, shopping cart, narrow pillar etc. near the parking space
- There is a circular pillar or narrow pillar, or a pillar surrounded by objects such as fire extinguisher, etc. near the parking space
- There is heavy snow, rain or wind
- The vehicle is installed with a snow chain, spare tyre or different size wheel
- Tyre pressure is lower or higher than the standard tyre pressure
- The road is bumpy
- The road is slippery
- The parking space is near a vehicle with higher ground clearance or big, such as a truck, etc.
- Your vehicle is loaded with cargo longer or wider than your vehicle or a trailer is connected to your vehicle
- The sensor is mounted or positioned incorrectly by an impact to the bumper
- The parking space is Inclined
- There is a problem with the wheel alignment
- Your vehicle is leaned severely to one side
- Front or rear ultrasonic sensors are not working properly or does not work (Refer to "Forward/Reverse Parking Distance Warning (PDW) (if equipped)" on page 4-121.)

Remote Smart Parking Assist may not operate normally under the following circumstances:

- Parking on inclines



Park manually when parking on inclines.

- Parking in snow



Snow may interfere with sensor operation, or Remote Smart Parking Assist may cancel if the road is slippery whilst parking.

- Parking on uneven road



Remote Smart Parking Assist may cancel when the vehicle slips, or the vehicle cannot move due to road conditions such as pebbles or fragmented stones.

- Parking behind a truck



Do not use Remote Smart Parking Assist around vehicles with higher ground clearance, such as a bus, truck, etc. It may lead to an accident.

- Parking near a pillar



Remote Smart Parking Assist performance may reduce when there is a pillar or pillar surrounded by objects such as a fire extinguisher near the parking space.

- Parking in a parking space with a vehicle on one side only



If Remote Smart Parking Assist is used, when parking in a parking space with a vehicle only on one side, your vehicle may cross the parking line to avoid the parked vehicle.

- Parking diagonal

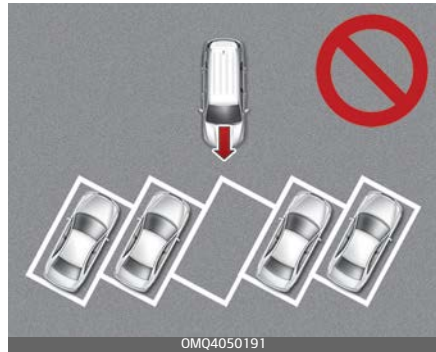

Remote Smart Parking Assist does not provide diagonal parking. Even if your vehicle was able to enter the parking space, do not use the function because the function cannot operate normally.

Declaration of conformity (if equipped)

The radio frequency components (Front Radar) complies:

For Europe and countries subject to CE certification



Model : MRR-20

Hereby MRR-20 has been so constructed that it can be operated in at least one Member State without infringing applicable requirements of use of radio spectrum. (RED article 10.2)

Hereby, Mando Corp declares that the radio equipment type MRR-20 is in compliance with Directive 2014/53/EU.

The full text of the EU declaration of conformity is available at the following internet address:
<https://www.mando.com/rnd/rnd04.jsp>

OMQ4PH051413L

For Taiwan



OMQ4PH051411L

CCAI19LP0490T6

(1) 經型式認證合格之低功率射頻電機，非經許可，公司、商號或使用者均不得擅自變更頻率、加大功率或變更原設計之特性及功能。
 (2) 低功率射頻電機之使用不得影響飛航安全及干擾合法通信；經發現有干擾現象時，應立即停用，並改善至無干擾時方得繼續使用。前項合法通信，指依電信法規定作業之無線電通信。低功率射頻電機須忍受合法通信或工業、科學及醫療用電波輻射性電機設備之干擾。

(1) Without permission granted by NCC, any company, enterprise, or user is not allowed to change frequency, enhance transmitting power or alter original characteristic as well as performance to a approved low power radio-frequency devices.

(2) The low power radio-frequency devices shall not influence aircraft security and interfere legal communications: If found, the user shall cease operating immediately until no interference is achieved.

The said legal communications means radio communications is operated in compliance with the Telecommunications Act.

The low power radio-frequency devices must be susceptible with the interference from legal communications or ISM radio wave radiated devices.

OCK060094TW

For Australia



OCK060062L

For Serbia



For Ukraine



For Oman



26. Manufacturers should ensure that radio equipment is accompanied by instructions and safety information in accordance with the law on the use of languages.

Instructions should include the information necessary to use the radio equipment according to its purpose. Such information contains, in the presence of a description of the components and accessories, including software that allows the radio equipment to work for its intended purpose. Such instructions and safety instructions, as well as any labeling, must be clear, understandable and legible.

An instruction for radio equipment intended to emit radio waves must additionally contain:

- band (bands) of radio frequencies, in which (in which) the radio equipment operates;
- the maximum radiation power in the band (s) of radio frequencies, in which (in which) radio equipment is operating.

OCK060066L

For Moldova



For UAE



For Brazil



XXXXX-XX-XXXXX

03849-18-09644

OMQ4PH051419L

For Singapore

Complies with
IMDA Standards
[Dealer's Licence No.]

Dealer number : DA105282

OMQ4PH051420L

For Russia



ODL3059224L

For Malaysia



HIDF16000136

OMQ4PH051421L

For Jordan

Model : MRR-20

OMQ4PH051422L

For Mexico

IFETEL : RCPMAMR18-1560

"La operación de este equipo está sujeta a las siguientes dos condiciones:

- (1) es posible que este equipo o dispositivo no cause interferencia perjudicial y
 - (2) este equipo o dispositivo debe aceptar cualquier interferencia, incluyendo la que pueda causar su operación no deseada."
- and RCPMAMR18-1560

OKA4050562L

For Israel

Ministry of Communication permit number :
51-63909

OMQ4PH051423L

The radio frequency components (Rear Corner Radar) complies:

For Ukraine



UA RF: 1APT V H5TR

OMQ4PH051399L

справжнім (найменування виробника) заявляє, що тип радіобладнання (позначення типу радіобладнання) відповідає Технічному регламенту радіобладнання;

повний текст декларації про відповідність доступний на веб-сайті за такою адресою:
www.aprtiv.com/automotive-homologation

OMQ4061053L

For Ghana

NCA approved: ZRO-MB-7E3-249

OMQ4PH051400L

For Republic of South Africa



TA-2019/1524

ICASA

APPROVED

OMQ4PH051401L

For Serbia



И61819

OMQ4PH051403L

For Paraguay



CONATEL

NR: 2019-12-I-0671

OMQ4PH051404L

For Malaysia



MCMC

CIDF17000143

OMQ4PH051405L

For Singapore

Complies with
IMDA Standards
DA 103787

Dealer's Licence : DA 103787

OMQ4PH051406L

For Europe and countries subject to CE certification

Declaration of Conformity
Radiocontrolled Vehicle components

CE

Hereby, APTIV, 42367 Wuppertal declares that this J4TR/J4TRh is in compliance with the essential requirements and other relevant provisions of Directive 2014/53/EU (RED).
The original declaration of conformity can be accessed at the following link :
www.aptiv.com/automotive-homologation

frequency band 76-77 GHz
Maximum Output Power 30 dBm (1.0 W)

OMQ4PH051407L

For Thailand



nano.

เครื่องวิทยุคมนาคมนี้ ได้รับยกเว้น ไม่ต้องได้
รับใบอนุญาตให้มี ใช้ซึ่งเครื่องวิทยุคมนาคม
หรือตั้งสถานวิทยุคมนาคมตามประกาศ กสทช.
เรื่อง เครื่องวิทยุคมนาคม และสถานีวิทยุ
คมนาคมที่ได้รับยกเว้นไม่ต้องได้รับใบอนุญาต
วิทยุคมนาคมตามพระราชบัญญัติวิทยุคมนาคม
พ.ศ. 2498



กสทช. | โทรคมนาคม

กำกับดูแลเพื่อประชาชน

Call Center 1200 (InSW@)

OMQ4PH051408L

For Israel

14. התקן המיועד להעברת הודעות המיועד להעברת הודעות של אירועי חירום של הסוכרן יודעת מוכנית, כי יהיה רשום כי-
א. המיועד במסגרת רישוי על בסיס "תעודת" ומספר רישוי הפעלה אלוטו.
כלומר - לא מוגן מתחנת ולא מתחנת למערכת אחרות הפועלות בדיו.
ב. רק "תעודת" בודק-לימים עובדי של הקמת בלבד, העודד עמוד רישוי הפעלה אלוטו.
ג. מתן "תעודת" בודק-לימים רישוי מיוחד ממשרד התעבורה.
ד. אסור להחליף את האנטנה המקורית של המכשיר, ולא לעשות בו כל שינוי מבני אחר.

תקן מספר : 63-67459

א. המיועד במסגרת רישוי על בסיס "תעודת" ומספר רישוי הפעלה אלוטו.
ב. רק "תעודת" בודק-לימים עובדי של הקמת בלבד, העודד עמוד רישוי הפעלה אלוטו.
ג. מתן "תעודת" בודק-לימים רישוי מיוחד ממשרד התעבורה.
ד. אסור להחליף את האנטנה המקורית של המכשיר, ולא לעשות בו כל שינוי מבני אחר.

בתחום תדרים של:
הספק היציאה של איש עלה על "output power of the device"

OMQ4PH051409L

For Brazil



XXXXX-XX-XXXXX

03849-18-09644

OMQ4PH051419L

Este equipamento opera em caráter secundário, isto é, não tem direito à proteção contra interferência prejudicial, mesmo de estações do mesmo tipo, e não pode causar interferência a sistemas operando em caráter primário.

OMQ4061055L

For Taiwan



電信法第 48 條, 低功率電波輻射性電機管理辦法

第十二條

經型式認證合格之低功率射頻電機, 非經許可, 公司、商號或使用者均不得擅自變更頻率、加大功率或變更原設計之特性及功能。

第十四條

低功率射頻電機之使用不得影響飛航安全及干擾合法通信; 經發現有干擾現象時, 應立即停用, 並改善至無干擾時方得繼續使用。前項合法通信, 指依電信法規定作業之無線電通信。低功率射頻電機須忍受合法通信或工業、科學及醫療用電波輻射性電機設備之干擾。

OMQ4061056L

For Mexico

IFETEL: RCPAPH519-1602

"La operación de este equipo está sujeta a las siguientes dos condiciones:

(1) es posible que este equipo o dispositivo no cause interferencia perjudicial y (2) este equipo o dispositivo debe aceptar cualquier interferencia, incluyendo la que pueda causar su operación no deseada."

OMQ4A061072

For UAE



OMQ4061058L

For Jordan

TRC/31/7635/2020

OMQ4061057L

Economical operation

Your vehicle's fuel economy depends mainly on your style of driving, where you drive and when you drive.

Each of these factors affects how many kilometres (miles) you can get from a litre (gallon) of fuel. To operate your vehicle as economically as possible, use the following driving suggestions to help save money in both fuel and repairs:

- Drive smoothly. Accelerate at a moderate rate. Don't make "jack-rabbit" starts or full-throttle shifts and maintain a steady cruising speed. Don't race between stoplights. Try to adjust your speed to the traffic so you don't have to change speeds unnecessarily. Avoid heavy traffic whenever possible.

Always maintain a safe distance from other vehicles so you can avoid unnecessary braking. This also reduces brake wear.

- Drive at a moderate speed. The faster you drive, the more fuel your vehicle uses. Driving at a moderate speed, especially on the highway, is one of the most effective ways to reduce fuel consumption.
- Take care of your tyres. Keep them inflated to the recommended pressure. Incorrect inflation, either too much or too little, results in unnecessary tyre wear.

Check the tyre pressures at least once a month.

- Be sure that the wheels are aligned correctly. Improper alignment can result from hitting kerbs or driving too fast over irregular surfaces. Poor alignment causes faster tyre wear and may also result in other problems as well as greater fuel consumption.
- Keep your vehicle in good condition. For better fuel economy and reduced maintenance costs, maintain your vehicle in accordance with the maintenance schedule in "Scheduled maintenance service" on page 8-9. If you drive your vehicle in severe conditions, more frequent maintenance is required (Refer to "Maintenance under severe usage conditions—for Europe" on page 8-18).
- Travel lightly. Don't carry unnecessary weight in your vehicle. Weight reduces fuel economy.
- Don't let the engine idle longer than necessary. If you are waiting (and not in traffic), turn off your engine and restart only when you're ready to go.
- Don't "lug" or "over-rev" the engine. Lugging is driving too slowly in too high a gear resulting in the engine bucking. If this happens, shift to a lower gear. Over-revving is racing the engine beyond its safe limit. This can be

avoided by shifting at the recommended speeds.

- Open windows at high speeds can reduce fuel economy.
- Fuel economy is less in crosswinds and headwinds. To help offset some of this loss, slow down when driving in these conditions.

Keeping a vehicle in good operating condition is important both for economy and safety.

Therefore, have the function serviced by a professional workshop. Kia recommends to visit an authorised Kia dealer/service partner.

WARNING

Engine off during motion

Never turn the engine off to coast down hills or anytime the vehicle is in motion. The power steering and power brakes will not function properly without the engine running. In addition, turning off the ignition whilst driving could engage the steering wheel lock resulting in loss of vehicle steering. Keep the engine on and downshift to an appropriate gear for engine braking effect.

Special driving conditions

If driving conditions deteriorate due to poor weather or road conditions, you should pay even more attention than usual to your driving.

Hazardous driving conditions

When hazardous driving conditions are encountered such as water, snow, ice, mud, sand, or similar hazards, follow these suggestions:

- Drive cautiously and allow extra distance for braking.
- Avoid sudden braking or steering.
- Do not pump the brake pedal on a vehicle equipped with ABS.
- If stalled in snow, mud, or sand, use the second gear. Accelerate slowly to avoid spinning the drive wheels.
- Use sand, rock salt, or other non-slip material under the drive wheels to provide traction when stalled in ice, snow, or mud.

Reducing the risk of a rollover

This multi-purpose passenger vehicle is defined as a Sports Utility Vehicle (SUV). Utility vehicles have a significantly higher rollover rate than other types of vehicles. SUVs have higher ground clearance and a narrower track to make them capable of performing in a wide variety of offroad applications.

Specific design characteristics give them a higher centre of gravity than ordinary vehicles. An advantage of the higher ground clearance is a better view of the road, which allows you to anticipate problems.

They are not designed for cornering at the same speeds as conventional passenger vehicles, any more than low-slung sports vehicles are designed to perform satisfactorily in off-road conditions. Due to this risk, driver and passengers are strongly recommended to buckle their seat belts.

In a rollover crash, an unbelted person is significantly more likely to die than a person wearing a seat belt. There are steps that a driver can make to reduce the risk of a rollover.

If at all possible, avoid sharp turns or abrupt manoeuvres, do not load your roof rack with heavy cargo, and never modify your vehicle in any way.

WARNING

Rollover

As with other Sports Utility Vehicle (SUV), failure to operate this vehicle correctly may result in loss of control, an accident or vehicle rollover.

- Utility vehicles have a significantly higher rollover rate than other types of vehicles.

- Specific design characteristics (higher ground clearance, narrower track, etc.) give this vehicle a higher centre of gravity than ordinary vehicles.
- A SUV is not designed for cornering at the same speeds as conventional vehicles.
- Avoid sharp turns or abrupt manoeuvres.
- In a rollover crash, an unbelted person is significantly more likely to die than a person wearing a seat belt. Make sure everyone in the vehicle is properly buckled up.

WARNING

Your vehicle is equipped with tyres designed to provide safe ride and handling capability. Do not use tyres and wheels that are different in size and type from the originally installed ones. It can affect the safety and performance of your vehicle, which could lead to steering failure or rollover and serious injury. When replacing the tyres, be sure to equip all four tyres with the tyre and wheel of the same size, type, tread, brand and load-carrying capacity.

Rocking the vehicle

If it is necessary to rock the vehicle to free it from snow, sand, or mud, first turn the steering wheel right and left to clear the area around your front wheels. Then, shift back and forth between R (Reverse) and any forward gear.

Do not race the engine, and spin the wheels as little as possible. If you are still stuck after a few tries, have the vehicle pulled out by a tow vehicle to avoid engine overheating and possible damage to the transmission.

⚠️ WARNING

Sudden vehicle movement

Do not attempt to rock the vehicle if people or objects are nearby. The vehicle may suddenly move forward or backwards as it becomes unstuck.

⚠️ CAUTION

Vehicle rocking

Prolonged rocking may cause vehicle overheating, transmission damage or failure, and tyre damage.

⚠️ CAUTION

Spinning tyres

Do not spin the wheels, especially at speeds more than 56 km/h (35 mph). Spinning the wheels at high speeds when the vehicle is stationary could overheat and damage tyres, and the rotating wheels may fly away and injure bystanders.

* NOTICE

The Electronic Stability Control (ESC) should be turned OFF prior to rocking the vehicle.

Smooth cornering



Avoid braking or gear changing in corners, especially when roads are wet. Ideally, corners should always be taken under gentle acceleration. If you follow these suggestions, tyre wear will be held to a minimum.

Driving at night



OMQ4H050018

Because night driving presents more hazards than driving in the daylight, here are some important tips to remember:

- Slow down and keep more distance between you and other vehicles, as it may be more difficult to see at night, especially in areas where there may not be any street lights.
- Adjust your mirrors to reduce the glare from other driver's headlights.
- Keep your headlights clean and properly aimed. (On vehicles not equipped with the automatic headlight aiming feature.) Dirty or improperly aimed headlights will make it much more difficult to see at night.
- Avoid staring directly at the headlights of oncoming vehicles. You could be temporarily blinded, and it will take several seconds for your eyes to readjust to the darkness.

Driving in the rain



OMQ4H061016L

Rain and wet roads can make driving dangerous, especially if you're not prepared for the slick pavement.

Here are a few things to consider when driving in the rain:

- A heavy rainfall will make it harder to see and will increase the distance needed to stop your vehicle, so slow down.
- Keep your windscreen wiping equipment in good shape. Replace your windscreen wiper blades when they show signs of streaking or missing areas on the windscreen.
- If your tyres are not in good condition, making a quick stop on wet pavement can cause a skid and possibly lead to an accident. Be sure your tyres are in good shape.
- Turn on your headlights to make it easier for others to see you.
- Driving too fast through large puddles can affect your brakes. If you must go through puddles, try to drive through them slowly.

- If you believe you may have gotten your brakes wet, apply them lightly whilst driving until normal braking operation returns.

Hydroplaning

If the road is wet enough and you are going fast enough, your vehicle may have little or no contact with the road surface and actually ride on the water. The best advice is SLOW DOWN when the road is wet.

The risk of hydroplaning increases as the depth of tyre tread decreases, refer to "Tyre replacement" on page 8-54.

Driving in flooded areas

Avoid driving through flooded areas unless you are sure the water is no higher than the bottom of the wheel hub. Drive through any water slowly. Allow adequate stopping distance because brake performance may be affected.

After driving through water, dry the brakes by gently applying them several times whilst the vehicle is moving slowly.

Highway driving



Tyres

Adjust the tyre inflation pressures to specification. Low tyre inflation pressures will result in overheating and possible failure of the tyres. Avoid using worn or damaged tyres which may result in reduced traction or tyre failure. Never exceed the maximum tyre inflation pressure shown on the tyres.

⚠ WARNING

Under/over inflated tyres

Always check the tyres for proper inflation before driving. Underinflated or overinflated tyres can cause poor handling, loss of vehicle control, and sudden tyre failure, leading to accidents, injuries, and even death. For proper tyre pressures, refer to "Tyres and wheels" on page 8-50.

⚠ WARNING**Tyre tread**

Always check the tyre tread before driving your vehicle. Worn-out tyres can result in loss of vehicle control. Worn-out tyres should be replaced as soon as possible. For further information and tread limits, refer to "Tyres and wheels" on page 8–50.

Fuel, engine coolant and engine oil

High speed travel consumes more fuel than urban motoring. Do not forget to check both the engine coolant and engine oil.

Drive belt

A loose or damaged drive belt may result in overheating of the engine.

Winter driving

Severe weather conditions in the winter result in greater wear and other problems.

To minimise the problems of winter driving, you should follow these suggestions:

Snow tyres and tyre chains for the national language (Icelandic, Bulgarian) see the Appendix.

Snowy or icy conditions

To drive your vehicle in deep snow, it may be necessary to use snow tyres or to install tyre chains on your tyres.

If snow tyres are needed, it is necessary to select tyres equivalent in size and type of the original equipment tyres. Failure to do so may adversely affect the safety and handling of your vehicle. Furthermore, speeding, rapid acceleration, sudden brake applications, and sharp turns are potentially very hazardous practices.

During deceleration, use vehicle braking to the fullest extent. Sudden brake applications on snowy or icy roads may cause skids to occur. You need to keep sufficient distance between the vehicle in operation in front of your vehicle. Also, apply the brake gently. It should be noted that installing tyre chains on the tyre will

provide a greater driving force, but will not prevent side skids.

Tyre chains are not legal in all states. Check state laws before fitting tyre chains.

Snow tyres

If you mount snow tyres on your vehicle, make sure they are radial tyres of the same size and load range as the original tyres. Mount snow tyres on all four wheels to balance your vehicle's handling in all weather conditions. Keep in mind that the traction provided by snow tyres on dry roads may not be as high as your vehicle's original equipment tyres. You should drive cautiously even when the roads are clear. Check with the tyre dealer for maximum speed recommendations.

Do not install studded tyres without first checking local, state and municipal regulations for possible restrictions against their use.

WARNING

Snow tyre size

Snow tyres should be equivalent in size and type to the vehicle's standard tyres. Otherwise, the safety and handling of your vehicle may be adversely affected.

Tyre chains

wire-type



fabric-type



Since the sidewalls of radial tyres are thinner, they can be damaged by mounting some types of snow chains on them. Therefore, the use of snow tyres is recommended instead of snow chains. Do not mount tyre chains on vehicles equipped with aluminium wheels; snow chains may cause damage to the wheels. If snow chains must be used, use fabric-type chains or wire-type chains with a thickness of less than 12 mm (0.47 in).

Damage to your vehicle caused by improper snow chain use is not covered by your vehicle manufacturers warranty.

When using tyre chains, attach them to the drive wheels as follows.

- Front wheel drive vehicle moves the front wheel as a power source. Thus, snow chains must be mounted to front tyres.
- All wheel drive vehicle must mount snow chains to front tyres. In this case, minimise the driving distance in order to prevent damage to the all wheel drive system.
- After mounting snow chains, drive slowly. If you hear noise caused by chains contacting the body, slow down until the noise stops and remove the chain as soon as you begin driving on cleared roads to prevent damage.
- Wrong size chains or improperly installed chains can damage your vehicle's brake lines, suspension, body and wheels. Therefore, when installing snow chain, follow the manufacturer's instructions and mount them as tightly possible. Drive slowly (less than 30 km/h (20 mph)) with chains installed.

CAUTION

- Make sure the snow chains are the correct size and type for your tyres. Incorrect snow chains can cause damage to the vehicle body

and suspension and may not be covered by your vehicle manufacturer warranty. Also, the snow chain connecting hooks may be damaged from contacting vehicle components causing the snow chains to come loose from the tyre. Make sure the snow chains are SAE class "S" certified.

- Always check chain installation for proper mounting after driving approximately 0.5 to 1 km (0.3 to 0.6 miles) to ensure safe mounting. Retighten or remount the chains if they are loose.
- Fabric-type chains must be used on the vehicle with 19 inch (235/55R19) tyres.

Use high quality ethylene glycol coolant

Your vehicle is delivered with high quality ethylene glycol coolant in the cooling system. It is the only type of coolant that should be used because it helps prevent corrosion in the cooling system, lubricates the water pump and prevents freezing. Be sure to replace or replenish your coolant in accordance with the maintenance schedule in section 8.

Before winter, have your coolant tested to assure that its freezing point is sufficient for the temperatures anticipated during the winter.

Check battery and cables

Winter puts additional burdens on the battery system. Visually inspect the battery and cables as described in section 8. Have the level of charge in your battery checked by a professional workshop. Kia recommends to visit an authorised Kia dealer/service partner.

Change to "winter weight" oil if necessary

In some climates it is recommended that a lower viscosity "winter weight" oil be used during cold weather. See "Recommended lubricants and capacities" on page 9–9. If you aren't sure what weight oil you should use, Kia recommends to consult an authorised Kia dealer/service partner.

Check spark plugs and ignition system

Inspect your spark plugs as described in "Scheduled maintenance service" on page 8–9 and replace them if necessary. Also check all ignition wiring and components to be sure they are not cracked, worn or damaged in any way.

To keep locks from freezing

To keep the locks from freezing, squirt an approved de-icer fluid or glycerine into the key opening. If a lock is covered with ice, squirt it with an approved de-icing fluid to remove the ice. If the lock is frozen internally, you may be able to thaw it out by using a heated key. Handle the heated key with care to avoid injury.

Use approved window washer anti-freeze in system

To keep the water in the window washer system from freezing, add an approved window washer anti-freeze solution in accordance with instructions on the container. Window washer anti-freeze is available from an authorised Kia dealer/service partner and most auto parts outlets. Do not use engine coolant or other types of anti-freeze as these may damage the paint finish.

Don't let your parking brake freeze

Under some conditions your parking brake can freeze in the engaged position. This is most likely to happen when there is an accumulation of snow or ice around or near the rear brakes or if the brakes are wet. If there is a risk the parking brake may freeze, temporarily apply it with the gear in P (Park). Also, block the rear wheels in advance, so the

vehicle may not roll. Then release the parking brake.

Don't let ice and snow accumulate underneath

Under some conditions, snow and ice can build up under the fenders and interfere with the steering. When driving in severe winter conditions where this may happen, you should periodically check underneath the vehicle to be sure the movement of the front wheels and the steering components is not obstructed.

Carry emergency equipment

Depending on the severity of the weather, you should carry appropriate emergency equipment. Some of the items you may want to carry include tyre chains, tow straps or chains, flashlight, emergency flares, sand, shovel, jumper cables, window scraper, gloves, ground cloth, coveralls, blanket, etc.

Drive your vehicle when water vapor condenses and accumulates inside the exhaust pipes

When the vehicle is stopped for a long time in winter while the engine is running, water vapor may condense and accumulate inside the exhaust pipes.

Water in the exhaust pipes may cause noise, etc., but it is drained driving at medium to high speed.

Trailer towing (if equipped)

If you are considering towing with your vehicle, you should first check with your country's Department of Motor Vehicles to determine their legal requirements.

Since laws vary the requirements for towing trailers, cars, or other types of vehicles or apparatus may differ. Kia recommends to ask an authorised Kia dealer/service partner.

WARNING

Towing a trailer

If you don't use the correct equipment and drive improperly, you can lose control when you pull a trailer. For example, if the trailer is too heavy, the brakes may not work well – or even at all. You and your passengers could be seriously or fatally injured. Pull a trailer only if you have followed all the steps in this section.

WARNING

Weight limits

Before towing, make sure the total trailer weight, gross combination weight, gross vehicle weight, gross axle weight and trailer tongue load are all within the limits.

* NOTICE

- The technically permissible maximum load on the rear axle(s) may be exceeded by not more than 15 % and the technically permissible maximum laden mass of the vehicle may be exceeded by not more than 10 % or 100 kg (220.4 lbs), whichever value is lower. In this case, do not exceed 100 km/h (62.1 mph) for vehicle of category M1 or 80 km/h (49.7 mph) for vehicle of category N1.
- When towing a trailer, the additional load imposed at the trailer coupling device may cause the rear tyre maximum load ratings to be exceeded, but not by more than 15%. In such a case, do not exceed 100km/h, and the rear tyre pressure should be at least 20 kPa (0.2 bar) above the tyre pressure(s) as recommended for normal use (i.e. without a trailer attached).

CAUTION

Pulling a trailer improperly can damage your vehicle and result in costly repairs not covered by your warranty. To pull a trailer correctly, follow the advice in this section.

Your vehicle can tow a trailer. To identify what the vehicle trailering capacity is for your vehicle, refer to "Weight of the trailer" on page 6-240 that appears later in this section.

Remember that trailering is different than just driving your vehicle by itself. Trailering means changes in handling, durability, and fuel economy. Successful, safe trailering requires correct equipment, and it has to be used properly.

This section contains many timetested, important trailering tips and safety rules. Many of these are important for your safety and that of your passengers. Please read this section carefully before you pull a trailer.

Load-pulling components such as the engine, transmission, wheel assemblies, and tyres are forced to work harder against the load of the added weight. The engine is required to operate at relatively higher speeds and under greater loads. This additional burden generates extra heat. The trailer also considerably adds wind resistance, increasing pulling requirements.

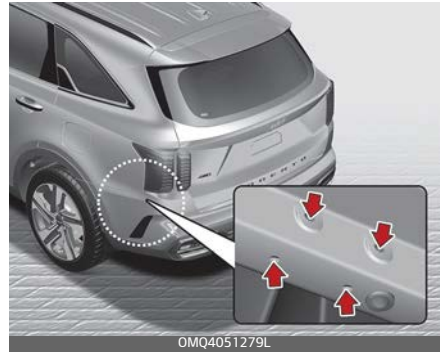

* NOTICE

Location of trailer mounting

The mounting hole for hitches are located on both sides of the underbody behind the rear tyres.

Hitches

It's important to have the correct hitch equipment. Crosswinds, large trucks going by, and rough roads are a few reasons why you'll need the right hitch. Here are some rules to follow:

- Do you have to make any holes in the body of your vehicle when you install a trailer hitch? If you do, then be sure to seal the holes later when you remove the hitch. If you don't seal them, deadly carbon monoxide (CO) from your exhaust can get into your vehicle, as well as dirt and water.
- The bumpers on your vehicle are not intended for hitches. Do not attach rental hitches or other

bumper-type hitches. Use only a frame-mounted hitch that does not attach to the bumper.

- Any part of the rear number plate or lighting devices of the vehicle must not be obscured by the mechanical coupling device. If the rear number plate and/or lighting devices can be obscured partially by any part of the mechanical coupling device, mechanical coupling devices that cannot be easily removed or repositioned without use of any tools, except an easily operated (i.e. an effort not exceeding 20 Nm) release key which is supplied by the manufacturer of the coupling device, are not permitted for use. Please note that the mechanical coupling device that is fitted and not in use must always be removed or repositioned if the rear number plate and/or rear lighting devices are obscured by any part of the mechanical coupling device.

- Kia trailer hitch accessory is available at an authorised Kia dealer/service partner.

Safety chains

You should always attach chains between your vehicle and your trailer. Cross the safety chains under the tongue of the trailer so that the tongue will not drop to the road if it becomes separated from the hitch.

Instructions about safety chains may be provided by the hitch manufacturer or by the trailer manufacturer. Follow the manufacturer's recommendation for attaching safety chains. Always leave just enough slack so you can turn with your trailer. And, never allow safety chains drag on the ground.

Trailer brakes

If your trailer is equipped with a braking system, make sure it conforms to your country's regulations and that it is properly installed and operating correctly.

If your trailer weighs more than the maximum trailer weight without trailer brakes loaded, then it needs its own brakes and they must be adequate. Be sure to read and follow the instructions for the trailer brakes so you'll be able to install, adjust and maintain them properly.

- Don't tap into your vehicle's brake system.

WARNING

Trailer brakes

Do not use a trailer with its own brakes unless you are absolutely certain that you have properly set up the brake system. This is not a task for amateurs. Use an experienced, competent trailer shop for this work.

Driving with a trailer

Towing a trailer requires a certain amount of experience. Before setting out for the open road, you must get to know your trailer. Acquaint yourself with the feel of handling and braking with the added weight of the trailer. And always keep in mind that the vehicle you are driving is now a good deal longer and not nearly so responsive as your vehicle is by itself.

Before you start, check the trailer hitch and platform, safety chains, electrical connector(s), lights, tyres and mirror adjustment. If the trailer has electric brakes, start your vehicle and trailer moving and then apply the trailer brake controller by hand to be sure the brakes are working. This lets you check your

electrical connection at the same time.

During your trip, check occasionally to be sure that the load is secure, and that the lights and trailer brakes are still working.

Following distance

Stay at least twice as far behind the vehicle ahead as you would when driving your vehicle without a trailer. This can help you avoid situations that require heavy braking and sudden turns.

Passing

You'll need more passing distance up ahead when you're towing a trailer. And, because of the increased vehicle length, you'll need to go much farther beyond the passed vehicle before you can return to your lane.

Backing up

Hold the bottom of the steering wheel with one hand. Then, to move the trailer to the left, just move your hand to the left. To move the trailer to the right, move your hand to the right. Always back up slowly and, if possible, have someone guide you.

Making turns

When you're turning with a trailer, make wider turns than normal. Do this so your trailer won't strike soft shoulders, kerbs, road signs, trees, or other objects. Avoid jerky or sudden manoeuvres. Signal well in advance.

Turn signals when towing a trailer

When you tow a trailer, your vehicle has to have a different turn signal flasher and extra wiring. The green arrows on your instrument panel will flash whenever you signal a turn or lane change. Properly connected, the trailer lights will also flash to alert other drivers you're about to turn, change lanes, or stop.

When towing a trailer, the green arrows on your instrument panel will flash for turns even if the bulbs on the trailer are burned out. Thus, you may think drivers behind you are seeing your signals when, in fact, they are not. It's important to check occasionally to be sure the trailer bulbs are still working. You must also check the lights every time you disconnect and then reconnect the wires.

Do not connect a trailer lighting system directly to your vehicle's lighting system. Use only an approved trailer wiring harness.

Have yourself assisted by a professional workshop in installing the wiring harness.

Kia recommends to visit an authorised Kia dealer/service partner.

⚠ WARNING

Failure to use an approved trailer wiring harness could result in damage to the vehicle electrical system and/or personal injury.

Driving on grades

Reduce the speed and shift to a lower gear before you start down a long or steep downgrade. If you don't shift down, you might have to use your brakes so much that they would get hot and no longer operate efficiently.

On a long uphill grade, shift down and reduce your speed to around 70 km/h (45 mph) to reduce the possibility of engine and transmission overheating.

⚠ CAUTION

- When towing a trailer on steep grades (in excess of 6%) pay close attention to the engine coolant temperature gauge to ensure the engine does not overheat. If the needle of the coolant tempera-

ture gauge moves across the dial towards "H (HOT) (or 130 °C/260 °F)", pull over and stop as soon as it is safe to do so, and allow the engine to idle until it cools down. You may proceed once the engine has cooled sufficiently.

- You must decide the driving speed depending on trailer weight and uphill grade to reduce the possibility of engine and transmission overheating.

Parking on hills

Generally, if you have a trailer attached to your vehicle, you should not park your vehicle on a hill. People can be seriously or fatally injured, and both your vehicle and the trailer can be damaged if unexpectedly roll down hill.

⚠ WARNING

Parking on a hill

Parking your vehicle on a hill with a trailer attached could cause serious injury or death, should the trailer break loose.

However, if you ever have to park your trailer on a hill, here's how to do it:

1. Pull the vehicle into the parking space. Turn the steering wheel in the direction of the kerb (left if

headed down hill, right if headed up hill).

2. Set the parking brake and shut off the vehicle.
3. Place chocks under the trailer wheels on the down hill side of the wheels.
4. Start the vehicle, hold the brakes, shift to neutral, release the parking brake and slowly release the brakes until the trailer chocks absorb the load.
5. Reapply the brakes, reapply the parking brake.
6. Shut off the vehicle and release the vehicle brakes but leave the parking brake set.

⚠ WARNING

Parking brake

It can be dangerous to get out of your vehicle if the parking brake is not firmly set.

If you have left the engine running, the vehicle can move suddenly. You or others could be seriously or fatally injured.

When you are ready to leave after parking on a hill

1. Apply your brakes and hold the brake pedal down whilst you:
 - Start your engine;
 - Shift into gear; and
 - Release the parking brake.
2. Slowly remove your foot from the brake pedal.
3. Drive slowly until the trailer is clear of the chocks.
4. Stop and have someone pick up and store the chocks.

Maintenance when trailer towing

Your vehicle will need service more often when you regularly pull a trailer. Important items to pay particular attention to include engine oil, axle lubricant and cooling system fluid. Brake condition is another important item to frequently check. Each item is covered in this manual, and the Index will help you find them quickly. If you're trailering, it's a good idea to review these sections before you start your trip.

Don't forget to also maintain your trailer and hitch. Follow the maintenance schedule that accompanied your trailer and check it periodically. Preferably, conduct the check at the start of each day's driving. Most importantly, all hitch nuts and bolts should be tight.

CAUTION

- Due to higher load during trailer usage, overheating might occur in hot days or during uphill driving. If the coolant gauge indicates overheating, switch off the A/C and stop the vehicle in a safe area to cool down the engine.
- When towing, check the transmission fluid more frequently.
- If your vehicle is not equipped with an air conditioner, you should install a condenser fan to improve engine performance when towing a trailer.

If you do decide to pull a trailer

Here are some important points if you decide to pull a trailer:

- Consider using a sway control. You can ask a hitch dealer about sway control.
- Do not do any towing with your vehicle during its first 2,000 km (1,200 miles) in order to allow the engine to properly break in. Failure to heed this caution may result in serious engine or transmission damage.
- When towing a trailer, Kia recommends that you consult an authorised Kia dealer/service partner on additional requirements such as a towing kit, etc.

- Always drive your vehicle at a moderate speed (less than 100 km/h (60 mph)).
- On a long uphill grade, do not exceed 70 km/h (45 mph) or the posted towing speed limit, whichever is lower.
- The chart contains important considerations that have to do with weight:

For hybrid vehicle

Item		Petrol Engine
		Smartstream G1.6 T-GDi HEV
Maximum trailer weight*	Without brake system	750 kg (1,653 lbs.)
	With brake system	1,650 kg (3,637 lbs.)
Maximum permissible static vertical load on the coupling device		100 kg (220 lbs.)
Recommended distance from rear wheel centre to coupling point		1,150 mm (45.3 inch)

For plug-in hybrid vehicle (except Australia and New Zealand)

Item		Petrol Engine
		Smartstream G1.6 T-GDi PHEV
Maximum trailer weight*	Without brake system	750 kg (1,653 lbs.)
	With brake system	1,500 kg (3,307 lbs.)
Maximum permissible static vertical load on the coupling device		100 kg (220 lbs.)
Recommended distance from rear wheel centre to coupling point		1,150 mm (45.3 inch)

* For optimal system performance, Kia recommends to not exceed a gross train weight of 3,880kg (5 seats)

* For optimal system performance, Kia recommends to not exceed a gross train weight of 4,030kg (7 seats)

For plug-in hybrid vehicle (for Australia and New Zealand)

Item		Petrol Engine
		Smartstream G1.6 T-GDi PHEV
Maximum trailer weight*	Without brake System	750 kg (1,653 lbs.)
	With brake System	1,350 kg (2,976 lbs.)
Maximum permissible static vertical load on the coupling device		100 kg (220 lbs.)
Recommended distance from rear wheel centre to coupling point		1,150 mm (45.3 inch)

* For optimal system performance, Kia recommends to not exceed a gross train weight of 3,880kg (5 seats)

* For optimal system performance, Kia recommends to not exceed a gross train weight of 4,030kg (7 seats)

Weight of the trailer

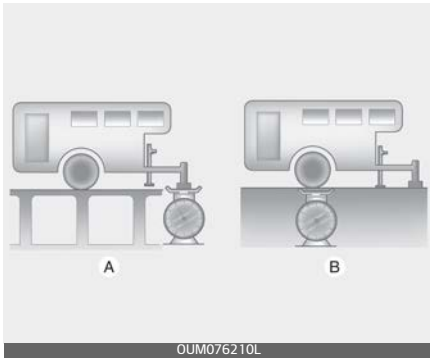

A: Tongue Load

B: Total Trailer Weight

What is the maximum safe weight of a trailer? It should never weigh more than the maximum trailer weight with trailer brakes. But even that can be too heavy.

It depends on how you plan to use your trailer. For example, speed, altitude, road grades, outside temperature and how often your vehicle is used to pull a trailer are all important. The ideal trailer weight can also depend on any special equipment that you have on your vehicle.

Weight of the trailer tongue

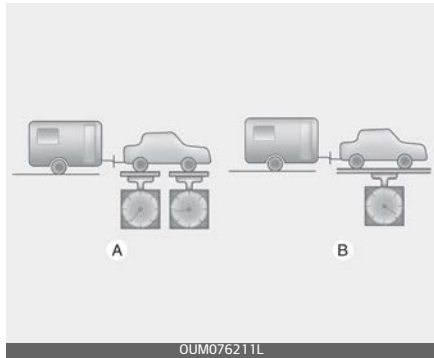

A: Gross Axle Weight

B: Gross Vehicle Weight

The tongue load of any trailer is an important weight to measure because it affects the total gross vehicle weight (GVW) of your vehicle. This weight includes the kerb weight of the vehicle, any cargo you may carry in it, and the people who will be riding in the vehicle. And if you tow a trailer, you must add the tongue load to the GVW because your vehicle will also be carrying that weight.

The trailer tongue should weigh a maximum of 10% of the total loaded trailer weight, within the limits of the maximum trailer tongue load permissible.

After you've loaded your trailer, weigh the trailer and then the tongue, separately, to see if the weights are proper. If they aren't, you may be able to correct them simply by moving some items around in the trailer.

⚠ WARNING

Trailer

- Never load a trailer with more weight in the rear than in the front. The front should be loaded with approximately 60% of the total trailer load; the rear should be loaded with approximately 40% of the total trailer load.
- Never exceed the maximum weight limits of the trailer or trailer towing equipment. Improper loading can result in damage to your vehicle and/or personal injury. Check weights and loading at a commercial scale or highway patrol office equipped with scales.
- An improperly loaded trailer can cause loss of vehicle control.

Vehicle weight

This section will guide you in the proper loading of your vehicle, to keep your loaded vehicle weight within its design rating capability. Properly loading your vehicle will provide maximum return of the vehicle design performance. Before loading your vehicle, familiarise yourself with the following terms for determining your vehicle's weight ratings, from the vehicle's specifications and the certification label:

Base kerb weight

This is the weight of the vehicle including a full tank of fuel and all standard equipment. It does not include passengers, cargo, or optional equipment.

Vehicle kerb weight

This is the weight of your new vehicle when you picked it up from your dealer plus any aftermarket equipment.

Cargo weight

This figure includes all weight added to the Base Kerb Weight, including cargo and optional equipment.

GAW (Gross axle weight)

This is the total weight placed on each axle (front and rear) – including vehicle kerb weight and all payload.

GAWR (Gross axle weight rating)

This is the maximum allowable weight that can be carried by a single axle (front or rear). These numbers are shown on the certification label. (if equipped)

The total load on each axle must never exceed its GAWR.

GVW (Gross vehicle weight)

This is the Base Kerb Weight plus actual Cargo Weight plus passengers.

GVWR (Gross vehicle weight rating)

This is the maximum allowable weight of the fully loaded vehicle (including all options, equipment, passengers and cargo). The GVWR is shown on the certification label located on the driver's (or front passenger's) door sill. (if equipped)

Overloading**⚠ WARNING****Vehicle weight**

The gross axle weight rating (GAWR) and the gross vehicle weight rating (GVWR) for your vehicle are on the certification label attached to the driver's (or front passenger's) door. Exceeding these ratings can cause an accident or vehicle damage. You can calculate the weight of your load by weighing the items (and people) before putting them in the vehicle. Be careful not to overload your vehicle.

Loading Your Vehicle – For Australia

Certification Label



Tyre Label

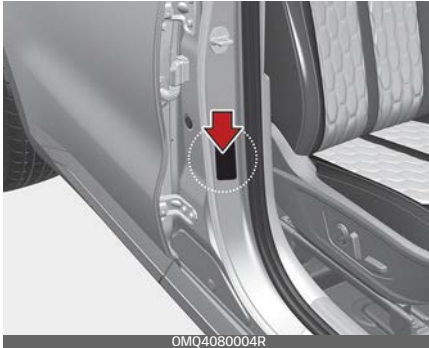

The Certification/Tyre label is found on the front edge of the RH (or LH) "B" pillar. The label shows the size of your original tyres and inflation pressures needed to obtain the gross weight capacity of your vehicle.

This is called the GVWR (Gross Vehicle Weight Rating). The GVWR includes the weight of the vehicle, all occupants, fuel and cargo. The Certification/Tyre label also tells you the maximum weights for the front and rear axles, called Gross Axle Weight Rating (GAWR).

Never exceed the GVWR for your vehicle, or the Gross Axle Weight Rating (GAWR) for either the front or rear axle. And, if you do have a heavy load, you should spread it out.

* NOTICE

Your warranty does not cover parts or components that fail because of overloading.

⚠ CAUTION

Do not load your vehicle any heavier than the GVWR or the maximum front and rear GAWRs. If you do, change to the vehicle may occur, or it can change the way your vehicle handles. These could cause you to lose control. Also, overloading can shorten the life of your vehicle.

Road warning	7-3
• Hazard warning flasher	7-3
In case of an emergency whilst driving	7-4
• If the vehicle stalls whilst driving.....	7-4
• If the engine stalls at a crossroad or crossing	7-4
• If you have a flat tyre whilst driving.....	7-4
If the engine will not start	7-5
• If engine doesn't turn over or turns over slowly	7-5
• If engine turns over normally but does not start.....	7-5
Emergency starting	7-6
• Jump-starting	7-6
• Push-starting.....	7-8
If the engine overheats	7-8
Tyre Pressure Monitoring System (TPMS)	7-10
• Low tyre pressure telltale	7-12
• Tyre Pressure Monitoring System (TPMS) malfunction indicator	7-13
• Changing a tyre with TPMS	7-14
If you have a flat tyre (with spare tyre)	7-16
• Jack and tools.....	7-16
• Removing and storing the spare tyre.....	7-17
• Changing tyres.....	7-19
• Important - use of compact spare tyre	7-23
• Jack label	7-25
• EC Declaration of Conformity for Jack	7-26
If you have a flat tyre (with tyre mobility kit)	7-27
• Introduction	7-27
• Components of the Tyre Mobility Kit.....	7-29

7 What to do in an emergency

• Using the Tyre Mobility Kit	7-30
• Distributing the sealant.....	7-32
• Checking the tyre inflation pressure.....	7-33
Towing.....	7-35
• Towing service.....	7-35
• Removable towing hook.....	7-36
• Emergency towing	7-36
Emergency commodity.....	7-39
• First aid kit.....	7-39
• Triangle reflector	7-39
• Tyre pressure gauge	7-39
Pan-European eCall system.....	7-40
• Description of the ecall in-vehicle system.....	7-41
• Information on data processing.....	7-42
• Pan-European eCall System.....	7-44

What to do in an emergency

Road warning

When in an emergency situation occurs whilst driving or when you park by the edge of the roadway, you must alert approaching or passing vehicles to be careful as they pass. For this, you should use the hazard warning flasher.

Hazard warning flasher

The hazard warning flasher serves as a warning to other drivers to exercise extreme caution when approaching, overtaking, or passing your vehicle.



It should be used whenever emergency repairs are being made or when the vehicle is stopped near the edge of a roadway.

Depress the flasher switch with the ENGINE START/STOP button in any position. The flasher switch is located in the centre fascia panel. All turn signal lights will flash simultaneously.

- The hazard warning flasher operates whether your vehicle is running or not.
- The turn signals do not work when the hazard flasher is on.
- Care must be taken when using the hazard warning flasher whilst the vehicle is being towed.

In case of an emergency whilst driving

If an emergency situation occurs whilst driving, stay calm and take the following steps.

If the vehicle stalls whilst driving

1. Reduce your speed gradually, keeping a straight line.
2. Move cautiously off the road to a safe place.
3. Turn on your hazard warning flasher.
4. Try to start the vehicle again. If your vehicle will not start, contact a professional workshop or seek other qualified assistance. Kia recommends to contact an authorised Kia dealer/service partner.

If the engine stalls at a crossroad or crossing

- If the engine stalls at a crossroad or crossing, set the gear in the N (Neutral) position and then push the vehicle to a safe place.

If you have a flat tyre whilst driving

1. Take your foot off the accelerator pedal and let the vehicle slow down whilst driving straight ahead.
Do not apply the brakes immediately or attempt to pull off the road as this may cause a loss of control.

2. When the vehicle has slowed to such a speed that it is safe to do so, brake carefully and pull off the road.
3. Drive off the road as far as possible and park on firm level ground. If you are on a divided highway, do not park in the median area between the two traffic lanes.
4. When the vehicle is stopped, turn on your emergency hazard flashers, set the parking brake and put the transmission in P.
5. Have all passengers get out of the vehicle. Be sure they all get out on the side of the vehicle that is away from traffic.
6. When changing a flat tyre, follow the instruction provided later in this section.

If the engine will not start

When the engine doesn't start, first check to see how much fuel there is and whether the battery is discharged.

If engine doesn't turn over or turns over slowly

1. Be sure the gear is in N (Neutral) or P (Park) and the emergency brake is set.
2. Check the battery connections to be sure they are clean and tight.
3. Turn on the interior light. If the light dims or goes out when you operate the starter, the battery is discharged.
4. Check the starter connections to be sure they are securely tightened.

Do not push or pull the vehicle to start it. This could cause damage to your vehicle. Refer to "Jump-starting" on page 7-6.

WARNING

If the engine will not start, do not push or pull the vehicle to start it. This could result in a collision or cause other damage. In addition, push or pull starting may cause the catalytic converter to be overloaded and create a fire hazard.

If engine turns over normally but does not start

1. Check the fuel level and add fuel if necessary.
2. With the ENGINE START/STOP button in the OFF position, check all connectors at the ignition coils and spark plugs. Reconnect any that may be disconnected or loose.
3. Check the fuel line in the engine compartment.
4. If the engine still does not start, call a professional workshop or seek other qualified assistance. Kia recommends to call an authorised Kia dealer/service partner.

Emergency starting

When the vehicle will not start because of low battery power, you may need to jump start the vehicle.

Jump-starting

Connect cables in numerical order and disconnect in reverse order.

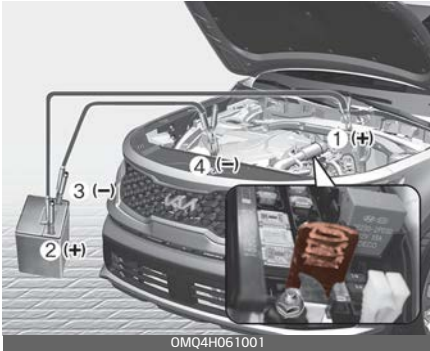

Jump-starting can be dangerous if done incorrectly. Therefore, to avoid harm to yourself or damage to your vehicle or battery, follow these jump-starting procedures. If in doubt, we strongly recommend that you have a competent technician or towing service jump-start your vehicle.

CAUTION

Use only a 12-volt jumper system. You can damage a 12-volt starting motor, ignition system, and other electrical parts beyond repair by use of a 24-volt power supply (either

two 12-volt batteries in series or a 24-volt motor generator set).

WARNING

Battery

Never attempt to check the electrolyte level of the battery as this may cause the battery to rupture or explode causing serious injury.

WARNING

Battery

- Keep all flames or sparks away from the battery. The battery produces hydrogen gas which may explode if exposed to flame or sparks. If these instructions are not followed exactly, serious personal injury and damage to the vehicle may occur! If you are not sure how to follow this procedure, seek qualified assistance. Automobile batteries contain sulfuric acid. This is poisonous and highly corrosive. When jump starting, wear protective glasses and be careful not to get acid on yourself, your clothing or on the vehicle.
- Do not attempt to jump start the vehicle if the discharged battery is frozen or if the electrolyte level is low; the battery may rupture or explode.

- Do not allow the (+) and (-) jumper cables to touch. It may cause sparks.
- The battery may rupture or explode when you jump start with a low or frozen battery.

Jump-starting

1. Make sure the booster battery is 12-volt and that its negative terminal is grounded.
If the booster battery is in another vehicle, do not allow the vehicles to come in contact.
2. Turn off all unnecessary electrical loads.
3. Connect the jumper cables in the exact sequence shown in the illustration.
 - 1) Connect one end of a jumper cable to the positive terminal of the discharged battery (1).
 - 2) Connect the other end to the positive terminal of the booster battery (2).
 - 3) Proceed to connect one end of the other jumper cable to the negative terminal of the booster battery (3), then the other end to a solid, stationary, metallic point away from the battery (4).
Do not allow the jumper cables to contact anything except the correct battery terminals or the correct ground. Do not lean over the battery when making connections.

4. If connected with the other vehicle, start the vehicle with the booster battery first and let it run at 2,000 rpm for several minutes.
5. Start the vehicle with the discharged battery.
6. If the engine starts, disconnect one end of the negative terminal of the booster battery (3), then other end of the positive terminal of the booster battery (2) and the discharged battery (1).

If the cause of your battery discharging is not apparent, you should have your vehicle checked by a professional workshop. Kia recommends to visit an authorised Kia dealer/service partner.

*** NOTICE**

Battery cables

Do not connect the jumper cable from the negative terminal of the booster battery to the negative terminal of the discharged battery. This can cause the discharged battery to overheat and crack, releasing battery acid.

Make sure to connect one end of the jumper cable to the negative terminal of the booster battery, and the other end to a metallic point, far away from the battery.

Push-starting

Vehicles equipped with automatic transmission cannot be push-started, and only jump starting can be applied. Follow the directions in this section for "Jump-starting" on page 7-6.

WARNING

Tow starting vehicle

Never tow a vehicle to start it. When the engine starts, the vehicle can suddenly surge forward and could cause a collision with the tow vehicle.

If the engine overheats

If your temperature gauge indicates overheating, you experience a loss of power, or hear a loud pinging or knocking, the engine will probably be too hot.

If this happens, you should:

1. Pull off the road and stop as soon as it is safe to do so.
2. Shift the gear to P (Park) and set the parking brake.
3. If the air conditioning is on, turn it off.
4. If engine coolant is running out under the vehicle or steam is coming out from underneath the bonnet, stop the engine. Do not open the bonnet until the coolant has stopped running or the steaming has stopped.
5. If there is no visible loss of engine coolant and no steam, leave the engine running and check to be sure the engine cooling fan is operating.
 - 1) If the fan is not running, turn the engine off.
6. Check to see if the water pump drive belt is missing.
 - 1) If it is not missing, check to see that it is tight.
 - 2) If the drive belt seems to be satisfactory, check for coolant leaking from the radiator, hoses or under the vehicle. (If the air conditioning had been in use, it is normal for cold water to be draining from it when you stop).

⚠ WARNING**Under the bonnet**

Whilst the engine is running, keep hair, hands and clothing away from moving parts, such as the fan and drive belts, to prevent injury.

7. If the water pump drive belt is broken or engine coolant is leaking out, stop the engine immediately and call the nearest a professional workshop for assistance. Kia recommends to call an authorised Kia dealer/service partner.
8. If you cannot find the cause of the overheating, wait until the engine temperature has returned to normal. If coolant has been lost, carefully add coolant to the reservoir to bring the fluid level in the reservoir up to the halfway mark.
9. Proceed with caution, keeping alert for further signs of overheating. If overheating happens again, call a professional workshop for assistance. Kia recommends to call an authorised Kia dealer/service partner.

⚠ WARNING**Coolant reservoir cap**

Do not remove the engine and inverter coolant reservoir cap when the engine is hot.

This may result in coolant being blown out of the opening and cause serious burns.

If the inverter coolant is running out, call the nearest a professional workshop for assistance. Kia recommends to call an authorised Kia dealer/service partner.

Use of other coolant type or water may damage the inverter.

⚠ CAUTION

- Serious loss of coolant indicates there is a leak in the cooling system and this should be checked as soon as possible by a professional workshop. Kia recommends to visit an authorised Kia dealer/service partner.
- When the engine overheats from low engine coolant, suddenly adding engine coolant may cause cracks in the engine. To prevent damage, add engine coolant slowly in small quantities.

⚠ WARNING



If there is not enough coolant for the electrical (power) system, have your vehicle

inspected by the professional workshop. Kia recommends to visit an authorised Kia dealer/service partner.

Refilling other type of antifreeze or water may cause malfunction or failure of the electrical (power) system.

Tyre Pressure Monitoring System (TPMS) (if equipped)



OMQ4061003R



OMQ4060004R

1. Low tyre pressure telltale /TPMS malfunction indicator
2. Low tyre pressure position telltale (Shown on the LCD display)

Check tyre pressure

- You can check the tyre pressure in the assist mode on the cluster.
 - Refer to "User settings mode" on page 5-84.
- Tyre pressure is displayed 1 ~ 2 minutes later after driving.
- If tyre pressure is not displayed when the vehicle is stopped,

"Drive to display" message displays. After driving, check the tyre pressure.

- You can change the tyre pressure unit in the user settings mode on the cluster.
 - psi, kpa, bar (Refer to "User settings mode" on page 5-84.

Each tyre, including the spare (if provided), should be checked monthly when cold and inflated to the inflation pressure recommended by the vehicle manufacturer on the vehicle placard or tyre inflation pressure label.

(If your vehicle has tyres of a different size than the size indicated on the vehicle placard or tyre inflation pressure label, you should determine the proper tyre inflation pressure for those tyres.)

As an added safety feature, your vehicle has been equipped with a tyre pressure monitoring system (TPMS) that illuminates a low tyre pressure telltale when one or more of your tyres is significantly under-inflated. Accordingly, when the low tyre pressure telltale illuminates, you should stop and check your tyres as soon as possible, and inflate them to the proper pressure. Driving on a significantly under-inflated tyre causes the tyre to overheat and can lead to tyre failure. Under-inflation also reduces

fuel efficiency and tyre tread life, and may affect the vehicle's handling and stopping ability.

Please note that the TPMS is not a substitute for proper tyre maintenance, and it is the driver's responsibility to maintain correct tyre pressure, even if under-inflation has not reached the level to trigger illumination of the TPMS low tyre pressure telltale.

Your vehicle has also been equipped with a TPMS malfunction indicator to indicate when the system is not operating properly. The TPMS malfunction indicator is combined with the low tyre pressure telltale. When the system detects a malfunction, the telltale will flash for approximately 1 minute and then remain continuously illuminated. This sequence will continue upon subsequent vehicle start-ups as long as the malfunction exists. When the TPMS malfunction indicator remains illuminated after blinking for approximately 1 minute, the system may not be able to detect or signal low tyre pressure as intended.

TPMS malfunctions may occur for a variety of reasons, including the installation of replacement or alternate tyres or wheels on the vehicle that prevent the TPMS from functioning properly. Always check the TPMS malfunction telltale after

replacing one or more tyres or wheels on your vehicle to ensure that the replacement or alternate tyres and wheels allow the TPMS to continue to function properly.

*** NOTICE**

If any of the below happens, have the system checked by a professional workshop. Kia recommends to visit an authorised Kia dealer/service partner.

1. The low tyre pressure telltale/ TPMS malfunction indicator do not illuminate for 3 seconds when the ignition switch is turned to the ON position or engine is running.
2. The TPMS malfunction indicator remains illuminated after blinking for approximately 1 minute.
3. The Low tyre pressure position telltale remains illuminated.

Low tyre pressure telltale 

Low tyre pressure position telltale



When the tyre pressure monitoring system warning indicators are illuminated and warning message displayed on the cluster LCD display, one or more of your tyres is significantly under-inflated. The low tyre pressure position telltale light will indicate which tyre is significantly under-inflated by illuminating the corresponding position light.

If either telltale illuminates, immediately reduce your speed, avoid hard cornering and anticipate increased stopping distances. You should stop and check your tyres as soon as possible. Inflate the tyres to the proper pressure as indicated on the vehicle's placard or tyre inflation pressure label located on the driver's side centre pillar outer panel. If you cannot reach a service station or if the tyre cannot hold the newly

added air, replace the low pressure tyre with a spare tyre.

If you drive the vehicle for about 10 minutes at speeds above 25 km/h after replacing the low pressure tyre with the spare tyre, one of the following will happen:

- The TPMS malfunction indicator may blink for approximately 1 minute and then remain continuously illuminated because the TPMS sensor is not mounted on the spare wheel. (changed tyre equipped with a sensor not in the vehicle)
- The TPMS malfunction indicator will remain continuously illuminated whilst driving because the TPMS sensor is not mounted on the spare wheel. (changed tyre equipped with a sensor in the vehicle)

CAUTION

- In winter or cold weather, the low tyre pressure telltale may illuminate if the tyre pressure was adjusted to the recommended tyre inflation pressure in warm weather. It does not mean your TPMS is malfunctioning because the decreased temperature leads to a lowering of tyre pressure.
- When you drive your vehicle from a warm area to a cold area or from a cold area to a warm area, or the outside temperature is

higher or lower, you should check the tyre inflation pressure and adjust the tyres to the recommended tyre inflation pressure.

- When filling tyres with more air, conditions to turn off the low tyre pressure telltale may not be met. This is because a tyre inflator has a margin of error in performance. The low tyre pressure telltale will be turned off if the tyre pressure is above the recommended tyre inflation pressure.

WARNING

Low pressure damage

Significantly low tyre pressure makes the vehicle unstable and can contribute to loss of vehicle control and increased braking distances. Continued driving on low pressure tyres can cause the tyres to over-heat and fail.

Tyre Pressure Monitoring System (TPMS) malfunction indicator

The TPMS malfunction indicator will illuminate after it blinks for approximately one minute when there is a problem with the Tyre Pressure Monitoring System.

In this case, have the system checked by a professional workshop to determine the cause of the prob-

lem. Kia recommends to visit an authorised Kia dealer/service partner.

*** NOTICE**

If there is a malfunction with the TPMS, the low tyre pressure position telltale will not be displayed even though the vehicle has an underinflated tyre.

⚠ CAUTION

- The TPMS malfunction indicator may blink for approximately 1 minute and then remain continuously illuminated if the vehicle is moving around electric power supply cables or radios transmitter such as at police stations, government and public offices, broadcasting stations, military installations, airports, or transmitting towers, etc. This can interfere with normal operation of the Tyre Pressure Monitoring System (TPMS).
- The TPMS malfunction indicator may blink for approximately 1 minute and then remain continuously illuminated if snow chains are used or some separate electronic devices such as notebook computer, mobile charger, or navigation etc., are used in the vehicle.

This can interfere with normal operation of the Tyre Pressure Monitoring System (TPMS).

Changing a tyre with TPMS

If you have a flat tyre, the low Tyre Pressure and Position telltales will come on. In this case, have the system checked by a professional workshop. Kia recommends to visit an authorised Kia dealer/service partner.

⚠ CAUTION

We recommend that you use the sealant approved by Kia. The sealant on the tyre pressure sensor and wheel shall be eliminated when you replace the tyre with a new one.

Each wheel is equipped with a tyre pressure sensor mounted inside the tyre behind the valve stem. You must use TPMS specific wheels. Have your tyres serviced by a professional workshop. Kia recommends to visit an authorised Kia dealer/service partner.

If you drive the vehicle for about 10 minutes at speeds above 25 km/h after replacing the low pressure tyre with the spare tyre, one of the following will happen:

- The TPMS malfunction indicator may blink for approximately 1 minute and then remain continuously illuminated because the TPMS sensor is not mounted on the spare wheel. (changed tyre equipped with a sensor not in the vehicle)
- The TPMS malfunction indicator will remain continuously illuminated whilst driving because the TPMS sensor is not mounted on the spare wheel. (changed tyre equipped with a sensor in the vehicle)

You may not be able to identify a low tyre by simply looking at it. Always use a good quality tyre pressure gauge to measure the tyre's inflation pressure. Please note that a tyre that is hot (from being driven) will have a higher pressure measurement than a tyre that is cold (from sitting stationary for at least 3 hours and driven less than 1 mile (1.6 km) during that 3 hour period).

Allow the tyre to cool before measuring the inflation pressure. Always be sure the tyre is cold before inflating to the recommended pressure.

A cold tyre means the vehicle has been sitting for 3 hours and driven for less than 1 mile (1.6 km) in that 3 hour period.

CAUTION

We recommend that you use the sealant approved by Kia if your vehicle is equipped with a Tyre Pressure Monitoring System. The liquid sealant can damage the tyre pressure sensors.

WARNING

TPMS

- The TPMS cannot alert you to severe and sudden tyre damage caused by external factors such as nails or road debris.
- If you feel any vehicle instability, immediately take your foot off the accelerator, apply the brakes gradually and with light force, and slowly move to a safe position off the road.

WARNING

Protecting TPMS

Tampering with, modifying, or disabling the Tyre Pressure Monitoring System (TPMS) components may interfere with the system's ability to warn the driver of low tyre pressure conditions and/or TPMS malfunctions. Tampering with, modifying, or disabling the Tyre Pressure Monitoring System (TPMS) components may void the warranty for that portion of the vehicle.

⚠ WARNING

- Do not modify the vehicle, it may interfere with the TPMS function.
- The wheels on the market do not have a TPMS sensor. For your safety, use parts for replacement from a professional workshop. Kia recommends to visit an authorised Kia dealer/service partner.
- If you use the wheels on the market, use a TPMS sensor approved by an authorised Kia dealer. If your vehicle is not equipped with a TPMS sensor or TPMS does not work properly, you may fail the periodic vehicle inspection conducted in your country.
- All vehicles sold in the EUROPE market during below period must be equipped with TPMS.
 - New model vehicle: Nov. 1, 2012 ~
 - Current model vehicle: Nov. 1, 2014 ~ (Based on vehicle registrations)

If you have a flat tyre (with spare tyre) (if equipped)

Jack and tools



The jack, jack handle, wheel lug nut wrench are stored in the luggage compartment.

Pull up the luggage box cover to reach this equipment.

1. Jack
2. Wheel lug nut wrench
3. Socket (if equipped)

Jacking instructions

The jack is provided for emergency tyre changing only.

To prevent the jack from "rattling" whilst the vehicle is in motion, store it properly.

Follow jacking instructions to reduce the possibility of personal injury.

⚠ WARNING

Be cautious as the minimum ground clearance gets lower when you store the original tyre in the bottom of the vehicle after replacing it with a spare tyre.

In particular, drive below 30 km/h (18 mph) when driving over a speed bump and on uphill/downhill/uneven road.

⚠ WARNING

Changing tyres

- Never attempt vehicle repairs in the traffic lanes of a public road or highway.
- Always move the vehicle completely off the road and onto the shoulder before trying to change a tyre. The jack should be used on firm level ground. If you cannot find a firm level place off the road, call a towing service company for assistance.
- Be sure to use the correct front and rear jacking positions on the vehicle; never use the bumpers or any other part of the vehicle for jacking support.
- The vehicle can roll off the jack causing serious injury or death.
- Do not get under a vehicle that is supported by a jack.
- Do not start or run the engine whilst the vehicle is on the jack.

- Do not allow anyone remain in the vehicle whilst it is on the jack.
- Make sure any children present are in a secure place away from the road and from the vehicle to be raised with the jack.

Removing and storing the spare tyre

Hybrid vehicle

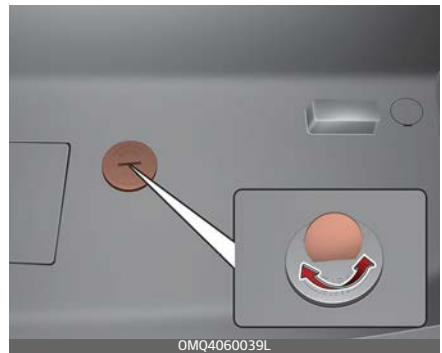

OMQ4060039L

Plug-in hybrid vehicle

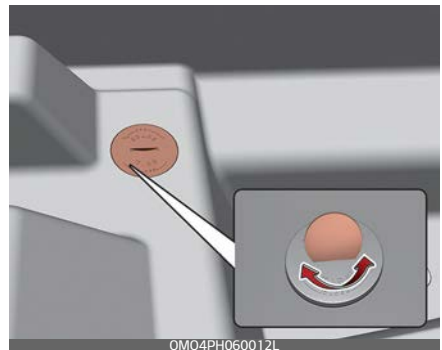

OMQ4PH060012L

Your spare tyre is stored underneath your vehicle, directly below the cargo area.

To remove the spare tyre:

What to do in an emergency

1. Open the tailgate.
2. Find the spare tyre fixing bolt cover and remove the cover. If necessary, separate the tool case only after removing the clamp.

Hybrid vehicle

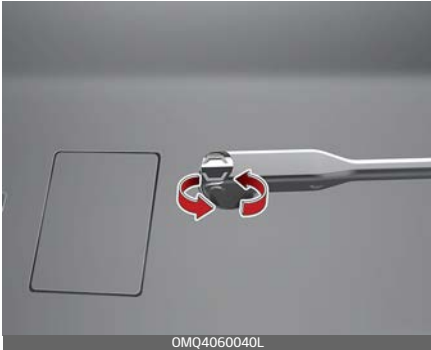

Plug-in hybrid vehicle



3. Connect the wheel lug nut wrench and the socket. (if equipped)
4. Use the wheel lug nut wrench to loosen the bolt enough to lower the spare tyre. Turn the wrench counterclockwise until the spare tyre reaches the ground.

If you have a flat tyre (with spare tyre)



5. After the spare tyre reaches the ground, continue to turn the wrench counterclockwise, and draw the spare tyre outside. Never rotate the wrench excessively, otherwise the spare tyre carrier may be damaged.
6. Remove the retainer (1) from the centre of the spare tyre.

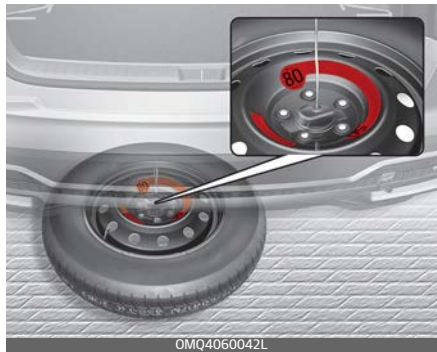

To store the spare tyre:

1. Lay the tyre on the ground with the valve stem facing up.
2. Place the wheel under the vehicle and install the retainer (1) through the wheel centre.

3. Turn the wrench clockwise until it clicks.

⚠ WARNING

Ensure the spare tyre retainer is properly aligned with the centre of the spare tyre to prevent the spare tyre from "rattling".

Otherwise, it may cause the spare tyre to fall off the carrier and lead to an accident.

Changing tyres



1. Park on a level surface and apply the parking brake firmly.
2. Shift the gear to P (Park), apply the parking brake, and turn the engine OFF.

3. Activate the hazard warning flasher.



4. Remove the wheel lug nut wrench, jack, and spare tyre from the vehicle.
5. Block both the front and rear of wheel that is diagonally opposite the jack position.

⚠ WARNING

Changing a tyre

- To prevent vehicle movement whilst changing a tyre, always set the parking brake fully, and always block the wheel diagonally opposite the wheel being changed.
- We recommend that the wheels of the vehicle be chocked, and that no person remain in a vehicle that is being jacked.



6. Loosen the wheel lug nuts counterclockwise one turn each, but do not remove any nut until the tyre has been raised off the ground.

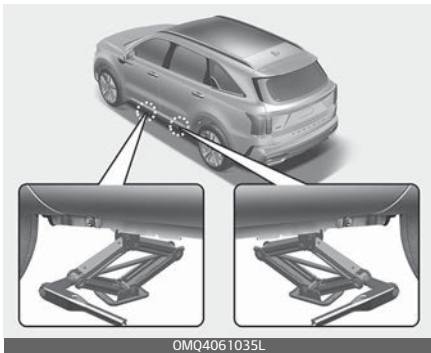
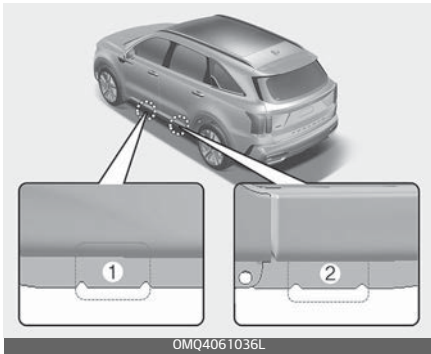

7. Place the jack at the front(1) or rear(2) jacking position closest to

the tyre you are changing. Place the jack at the designated locations under the frame. The jacking positions are plates welded to the frame with two tabs and a raised dot to index with the jack.

⚠ WARNING

Jack location

To reduce the possibility of injury, be sure to use only the jack provided with the vehicle and in the correct jack position; never use any other part of the vehicle for jack support.

8. Insert the wheel lug nut wrench into the jack and turn it clockwise, raising the vehicle until the tyre just clears the ground. This measurement is approximately 30 mm (1.2 in). Before removing the wheel lug nuts, make sure the vehicle is stable and that there is no chance for movement or slippage.



9. Loosen the wheel nuts and remove them with your fingers. Slide the wheel off the studs and

lay it flat so it cannot roll away. To put the wheel on the hub, pick up the spare tyre, line up the holes with the studs and slide the wheel onto them. If this is difficult, tip the wheel slightly and get the top hole in the wheel lined up with the top stud. Then jiggle the wheel back and forth until the wheel can be slid over the other studs.

⚠ WARNING

Wheels may have sharp edges. Handle them carefully to avoid possible severe injury. Before putting the wheel into place, be sure that there is nothing on the hub or wheel (such as mud, tar, gravel, etc.) that interferes with the wheel from fitting solidly against the hub.

If there is, remove it. If there is not good contact on the mounting surface between the wheel and hub, the wheel nuts could come loose and cause the loss of a wheel. Loss of a wheel may result in loss of control of the vehicle. This may cause serious injury or death.

10. To reinstall the wheel, hold it on the studs, put the wheel nuts on the studs and tighten them finger tight. Jiggle the tyre to be sure it is completely seated, then tighten the nuts as much as possible with your fingers again.

11. Lower the vehicle to the ground by turning the wheel nut wrench counterclockwise.



Then position the wrench as shown in the drawing and tighten the wheel nuts. Be sure the socket is seated completely over the nut. Do not stand on the wrench handle or use an extension pipe over the wrench handle. Go around the wheel tightening every other nut until they are all tight. Then double-check each nut for tightness. After changing wheels, have the system checked by a professional workshop. Kia recommends to visit an authorised Kia dealer/service partner.

Wheel nut tightening torque:

Steel wheel & aluminium alloy wheel:

11 ~ 13kgf·m (79 ~ 94lbf·ft)

If you have a tyre gauge, remove the valve cap and check the air pressure. If the pressure is lower than recommended, drive slowly to the nearest service station and inflate to the correct pressure. If it is too high, adjust it until it is correct.

Always reinstall the valve cap after checking or adjusting tyre pressure. If the cap is not replaced, air may leak from the tyre. If you lose a valve cap, buy another and install it as soon as possible.

After you have changed wheels, always secure the flat tyre in its place and return the jack and tools to their proper storage locations.

CAUTION

Your vehicle has metric threads on the wheel studs and nuts. Make certain during wheel removal that the same nuts that were removed are reinstalled – or, if replaced, that nuts with metric threads and the same chamfer configuration are used. Installation of a non-metric thread nut on a metric stud or vice-versa will not secure the wheel to the hub properly and will damage the stud so that it must be replaced.

Note that most lug nuts do not have metric threads. Be sure to use extreme care in checking for thread style before installing aftermarket lug nuts or wheels. If in doubt, consult a professional workshop. Kia recommends to consult an authorised Kia dealer/service partner.

WARNING

Wheel studs

If the studs are damaged, they may lose their ability to retain the wheel. This could lead to the loss of the wheel and a collision resulting in serious injuries.

To prevent the jack, jack handle, wheel lug nut wrench and spare tyre from rattling whilst the vehicle is in motion, store them properly.

WARNING

Inadequate spare tyre pressure

Check the inflation pressures as soon as possible after installing the spare tyre. Adjust it to the specified pressure, if necessary. Refer to "Tyres and wheels" on page 8-50.

Important - use of compact spare tyre (if equipped)

Your vehicle is equipped with a compact spare tyre. This compact spare tyre takes up less space than a regular-size tyre. This tyre is smaller than a conventional tyre and is designed for temporary use only.

⚠ CAUTION

- You should drive carefully when the compact spare is in use. The compact spare should be replaced by the proper conventional tyre and rim at the first opportunity.
- The operation of this vehicle is not recommended with more than one compact spare tyre in use at the same time.

⚠ WARNING

The compact spare tyre is for emergency use only. Do not operate your vehicle on this compact spare at the speed over 80 km/h (50 mph). The original tyre should be repaired or replaced as soon as possible to avoid failure of the spare possibly leading to personal injury or death.

The compact spare should be inflated to 420 kPa (60 psi).

⚠ CAUTION

Check the inflation pressure after installing the spare tyre. Adjust it to the specified pressure, as necessary.

When using a compact spare tyre, observe the following precautions:

- Under no circumstances should you exceed 80 km/h (50 mph); a higher speed could damage the tyre.
- Ensure that you drive slowly enough to avoid all hazards. Any road hazard, such as a pothole or debris, could seriously damage the compact spare.
- Any continuous road use of this tyre could result in tyre failure, loss of vehicle control, and possible personal injury.
- Do not exceed the vehicle's maximum load rating or the load-carrying capacity shown on the sidewall of the compact spare tyre.
- Avoid driving over obstacles. The compact spare tyre diameter is smaller than the diameter of a conventional tyre and reduces the ground clearance approximately 2.5 cm (1 inch), which could result in damage to the vehicle.
- Do not take the vehicle through an automatic car wash whilst the compact spare tyre is installed.

- Do not use tyre chains on the temporary compact tyre. Because of the smaller size, a tyre chain will not fit properly. This could damage the vehicle and result in loss of the chain.
- Temporary compact tyre should not be installed on the front axle if the vehicle must be driven in snow or on ice.
- Do not use the temporary compact tyre on any other vehicle because this tyre has been designed especially for your vehicle.
- The temporary compact tyre tread life is shorter than a regular tyre. Inspect your temporary compact tyre regularly and replace worn compact spare tyres with the same size and design, mounted on the same wheel.
- The temporary compact tyre should not be used on any other wheels, nor should standard tyres, snow tyres, wheel covers or trim rings be used with the temporary compact spare wheel. If such use is attempted, damage to these items or other car components may occur.
- Do not use more than one temporary compact tyre at a time.
- Do not tow a trailer whilst the temporary compact tyre is installed.

Jack label

Type A



Type B

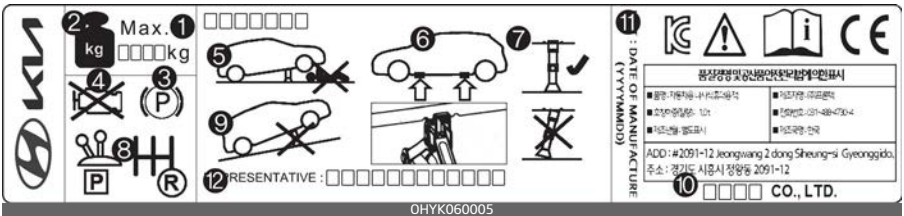

Type C



Type D (for Australia)

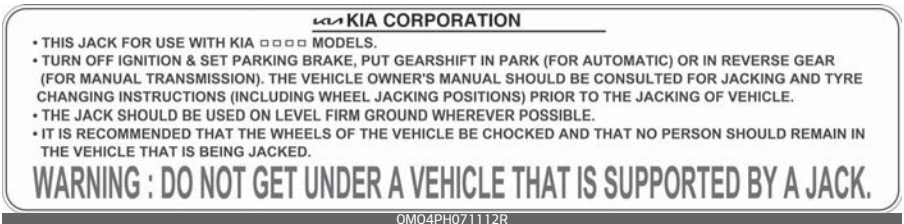

* The actual Jack label in the vehicle may differ from the illustration. For more detailed specifications, refer to the label attached to the jack.

1. Model Name
2. Maximum allowable load
3. When using the jack, set your parking brake.
4. When using the jack, stop the engine.

- 5. Do not get under a vehicle that is supported by a jack.
- 6. The designated locations under the frame
- 7. When supporting the vehicle, the base plate of jack must be vertical under the lifting point.
- 8. Move the shift position to the P (Park) position on vehicles.
- 9. The jack should be used on firm level ground.
- 10. Jack manufacturer
- 11. Production date
- 12. Representative company and address

EC Declaration of Conformity for Jack



EC Declaration of Conformity
according to EC Machinery Directive 2006/42/EC

We, **SAMKI IND. CO., LTD.**
175, Techno saneop-ro 29beom-gil, Nam-Gu, Ulsan, Korea 44776
declare under our sole responsibility that the product

Product : Jack Assembly
Brand Name : Pantograph Type
Type Designation(s) : Jack Assembly-600kg, Jack Assembly-700kg
Jack Assembly-800kg, Jack Assembly-1000kg
Jack Assembly-1200kg, Jack Assembly-1500kg
Serial No. : N/A (prototype)
Year fo Manufacture : 2020

to which this declaration relates is in conformity with the following standard(s) or other normative document(s);

EN ISO12100 (2010)	Safety of machinery - General principles for design – Risk assessment and risk reduction
EN 1494/A1 (2008)	Mobile or movable jacks and associated lifting equipment

following the provisions of Directive(s);
2006/42/EC Directive on the approximation of the laws of Member States relating to machinery (OJ L157 Jun, 9, 2006)

Ulsan_Korea / 09_03_2020 Byeong Suk, Choi President 

(Place and date of issue)(name and signature or equivalent making of authorized person)

* T.C.F Compiling Location
- Address: PRJIBORSKA 280, 739 43 FRYDEK MISTEK, CHLEBOVICE, CZECH REPUBLIC
- Train: Purchase train
- Company name: HANWHA

OMQ4060044L

If you have a flat tyre (with tyre mobility kit) (if equipped)

For safe operation, carefully read and follow the instructions in this manual before use.



1. Compressor
2. Sealant bottle

The Tyre Mobility Kit is a temporary fix to the tyre and We recommend that you have your vehicle inspected by an authorised Kia dealer/service partner.

⚠ CAUTION

One sealant for one tyre

When two or more tyres are flat, do not use the tyre mobility kit because the supported one sealant of Tyre Mobility Kit is only used for one flat tyre.

⚠ WARNING

Do not use the Tyre Mobility Kit to repair punctures in the tyre walls. This can result in an accident due to tyre failure.

⚠ WARNING

Have your tyre repaired as soon as possible. The tyre may loose air pressure at any time after inflating with the Tyre Mobility Kit.

Introduction

With the Tyre Mobility Kit you stay mobile even after experiencing a tyre puncture.

The system of compressor and sealing compound effectively and comfortably seals most punctures in a passenger car tyre caused by nails or similar objects and reinflates the tyre.

After you ensured that the tyre is properly sealed you can drive cautiously on the tyre (distance up to 200 km (120 miles)) at a max. speed of 80 km/h (50 mph) in order to reach a service station or tyre dealer to have the tyre replaced.

It is possible that some tyres, especially with larger punctures or damage to the sidewall, cannot be sealed completely.

Air pressure loss in the tyre may adversely affect tyre performance.

For this reason, you should avoid abrupt steering or other driving manoeuvres, especially if the vehicle is heavily loaded or if a trailer is in use.

The Tyre Mobility Kit is not designed or intended as a permanent tyre repair method and is to be used for one tyre only. This instruction shows you step by step how to temporarily seal the puncture simply and reliably.

Read the section "Notes on the safe use of the Tyre Mobility Kit" on page 7-34.

 **WARNING**

Do not use the TMK if a tyre is severely damaged by driving run flat or with insufficient air pressure.

Only punctured areas located within the tread region of the tyre can be sealed using the TMK.

Components of the Tyre Mobility Kit

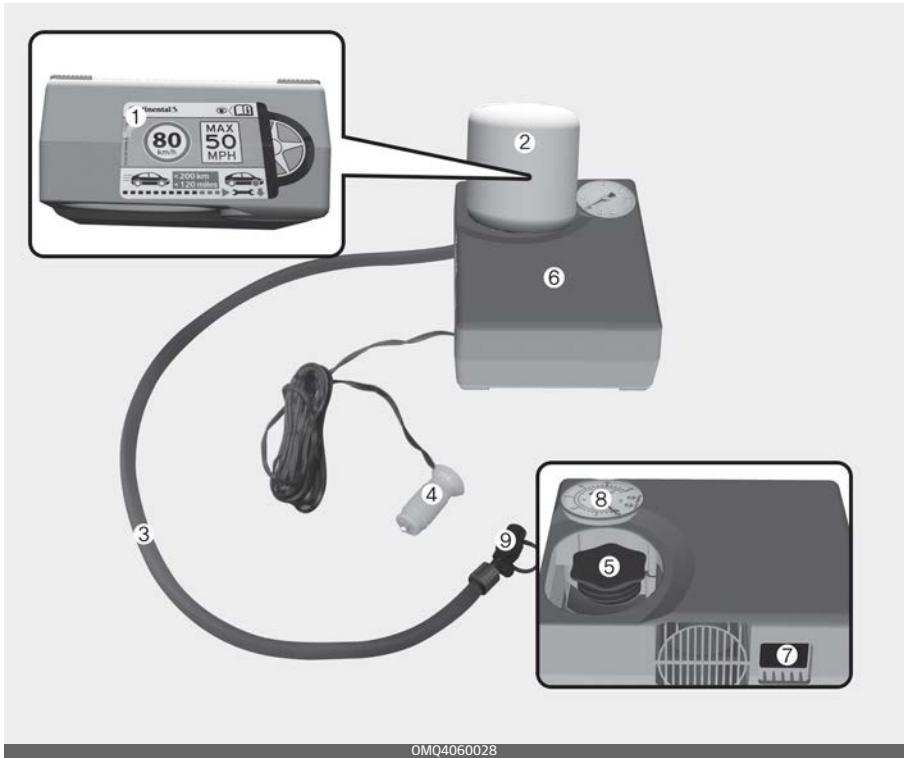

OMQ4060028

1. Speed-restriction label
2. Sealant bottle and label with speed restriction
3. Filling hose from sealant bottle to wheel
4. Connectors and cable for the power outlet direct connection
5. Holder for the sealant bottle
6. Compressor
7. ON/OFF switch
8. Pressure gauge for displaying the tyre inflation pressure
9. Valve for reducing the tyre inflation pressure

* Connectors, cable and connection hose are stored in the compressor housing.

* Strictly follow the specified sequence, otherwise the sealant may escape under high pressure.

⚠ WARNING

Expired sealant

Do not use the Tyre sealant after the sealant has expired (i.e. past the expiration date on the sealant container). This can increase the risk of tyre failure.

⚠ WARNING

Sealant

- Keep out of reach of children.
- Avoid contact with eyes.
- Do not swallow.

Using the Tyre Mobility Kit

⚠ CAUTION

Detach the speed restriction label from the sealant bottle, and place it in a highly visible place inside the vehicle such as on the steering wheel to remind the driver not to drive too fast.



1. Shake the sealant bottle.



2. Remove the cap of the sealant bottle and screw connection hose onto the connector of the sealant bottle.



What to do in an emergency

3. Ensure that valve on the compressor is locked.



4. Unscrew the valve cap from the valve of the defective tyre and screw the filling hose of the sealant bottle onto the tyre valve.



⚠ CAUTION

Securely install the sealant filling hose to the valve. If not, sealant may flow backward, possibly clogging the filling hose.

5. Ensure that the compressor is switched off, position 0.

If you have a flat tyre (with tyre mobility kit)

6. Connect between compressor and the vehicle power outlet using the cable and connectors.



7. Make the ENGINE START/STOP button position on or ignition switch position on.
8. Switch on the compressor and let it run for approximately 5 ~ 7 minutes to fill the sealant up to proper pressure. (refer to "Tyres and wheels" on page 8-50). The inflation pressure of the tyre after filling is unimportant and will be checked/corrected later. Be careful not to overinflate the tyre and stay away from the tyre when filling it. When the tyre and wheel are damaged, do not use Tyre Mobility Kit for your safety.

⚠ WARNING

If the tyre pressure is below 26psi(180kPa), do not drive the vehicle. The tyre may cause accident.

- 9. Switch off the compressor.
- 10. Detach the sealant filling hoses from the sealant bottle connector and from the tyre valve. After using, leave the sealant bottle and the compressor attached together.

Return the TMK to its storage location in the vehicle.

⚠ WARNING

Carbon monoxide

Do not leave your vehicle running in a poorly ventilated area for extended periods of time. Carbon monoxide poisoning and suffocation can occur.

Distributing the sealant

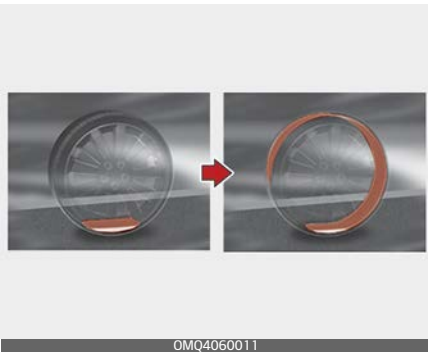

- Immediately drive approximately 7 ~ 10 km (4 ~ 6 miles or, about 10min) to evenly distribute the sealant in the tyre.

⚠ CAUTION

Do not exceed a speed of 80 km/h (50 mph). If possible, do not fall below a speed of 20 km/h (12 mph). Whilst driving, if you experience any unusual vibration, ride disturbance or noise, reduce your speed and drive with caution until you can safely pull off of the side of the road. Call for road side service or towing.

When you use the Tyre Mobility Kit, the wheel may be stained by sealant. Therefore, remove the wheel stained by sealant and have the vehicle inspected at a professional workshop. Kia recommends to visit an authorised Kia dealer/service partner.

Checking the tyre inflation pressure

1. After driving approximately 7 ~ 10 km (4 ~ 6 miles or about 10 min), stop at a safety location.
2. Connect the filling hose of the compressor directly to the tyre valve.



3. Connect between compressor and the vehicle power outlet using the cable and connectors.
4. Adjust the tyre inflation pressure to the recommended tyre inflation.

With the ignition switched on, proceed as follows.

- To increase the inflation pressure: Switch on the compressor. To check the current inflation pressure setting, briefly switch off the compressor.
- To reduce the inflation pressure: Turn the valve on the compressor.

⚠ WARNING

Do not let the compressor run for more than 10 minutes, otherwise the device will overheat and may be damaged.

⚠ CAUTION

If the inflation pressure is not maintained, drive the vehicle a second time, refer to "Distributing the sealant" on page 7-32. Then repeat steps 1 to 4.

Use of the TMK may be ineffectual for tyre damage larger than approximately 4 mm (0.16 of an inch).

We recommend that you contact a professional workshop if the tyre cannot be made roadworthy with the Tyre Mobility Kit.

⚠ WARNING

The tyre inflation pressure must be at least 180 kPa (26 psi). If it is not, do not continue driving. Call for road side service or towing.

* NOTICE

When reinstalling the repaired or replaced tyre and wheel on the vehicle, tighten the wheel lug nut to 11 ~ 13 kgf·m (79 ~ 94 lbf·ft).

Notes on the safe use of the Tyre Mobility Kit

- Park your car at the side of the road so that you can work with the TMK away from moving traffic. Place your warning triangle in a prominent place to make passing vehicles aware of your location.
- To be sure your vehicle will not move, even when you're on fairly level ground, always set your parking brake.
- Only use the TMK for sealing/ inflation passenger car tyres. Do not use on motorcycles, bicycles or any other type of tyres.
- Do not remove any foreign objects—such as nails or screws — that have penetrated the tyre.
- Before using the TMK, read the precautionary advice printed on the sealant bottle!
- Provided the car is outdoors, leave the engine running. Otherwise operating the compressor may eventually drain the car battery.
- Never leave the TMK unattended whilst it is being used.
- Do not leave the compressor running for more than 10 min. at a time or it may overheat.
- Do not use the TMK if the ambient temperature is below -30°C (-22°F).

- When the tyre and wheel are damaged, do not use Tyre Mobility Kit for your safety.

Technical Data

- System voltage: DC 12 V
- Working voltage: DC 12 V
- Amperage rating: max. 15 A
- Suitable for use at temperatures: -30 to 70°C (-22 to 158°F)
- Max. working pressure: 7 bar (101 psi)
- Size
 - Compressor: 150 x 130 x 60 mm (5.9 x 5.1 x 2.4 in.)
 - Sealant bottle: 115.3 x 87.3 \varnothing mm (4.5 x 3.4 \varnothing in.)
 - Compressor weight: 620 g (1.36 lbs)
 - Sealant volume: 400 ml (24.4 cu. in.)

* Sealant and spare parts can be obtained and replaced at an authorised vehicle or tyre dealer. Empty sealant bottles may be disposed of at home. Liquid residue from the sealant should be disposed of by your vehicle or tyre dealer or in accordance with local waste disposal regulations.

Towing

Towing service

If emergency towing is necessary, we recommend having it done by an authorised Kia dealer or a commercial tow-truck service.

Proper lifting and towing procedures are necessary to prevent damage to the vehicle. The use of wheel dollies (1) or flatbed is recommended.

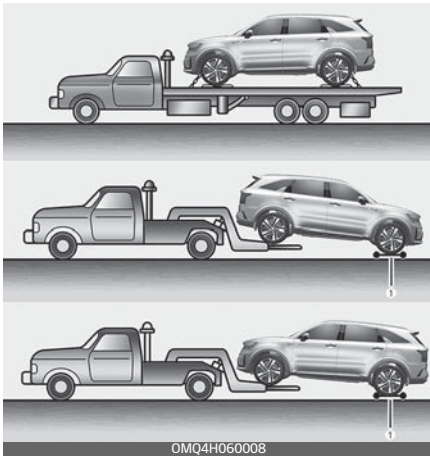

⚠ CAUTION

The AWD vehicle should never be towed with the wheels on the ground. This can cause serious damage to the transmission or the AWD system.

When flatbed is unavailable

2-wheel drive vehicle can be towed with the opposite tyres on the ground (without dollies) and parking brake released.

2-wheel drive vehicle (front wheel drive)



Shift to N (Neutral) to tow a vehicle with the tyres on the ground. For more details, refer to "Stay in N (Neutral) position when engine is Off" on page 6-19.

⚠ CAUTION

- If any of the loaded wheels or suspension components are damaged or the vehicle is being towed with the front wheels on the ground, use a towing dolly under the front wheels.



- Do not tow the vehicle backwards with the front wheels on the ground as this may cause damage to the vehicle.

2-wheel drive vehicle (front wheel drive)



- Attaching straps to the chassis, suspension or other parts of the body can cause damage.

1. Open the tailgate, and remove the towing hook from the tool case.
2. Remove the hole cover pressing the lower (front) or lower (rear) part of the cover on the bumper.
3. Install the towing hook by turning it clockwise into the hole until it is fully secured.
4. Remove the towing hook and install the cover after use.

Removable towing hook (if equipped)

Front

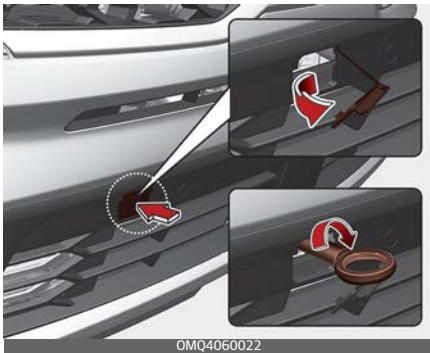

Rear

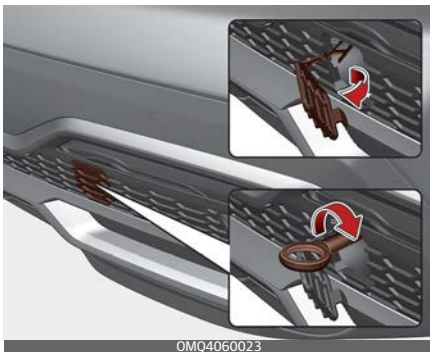

Emergency towing

Front

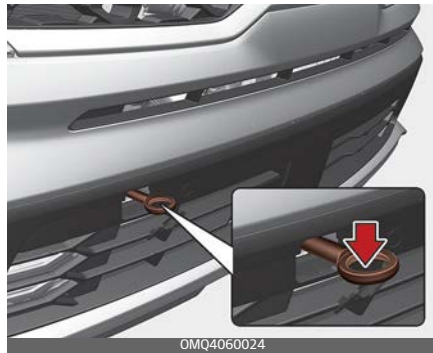

Rear



If towing is necessary, we recommend you to have it done by an

authorised Kia dealer or a commercial tow truck service.

If towing service is not available in an emergency, your vehicle may be temporarily towed using a cable or chain secured to the emergency towing hook under the front (or rear) of the vehicle. Use extreme caution when towing the vehicle. A driver must be in the vehicle to steer it and operate the brakes.

Towing in this manner may be done only on hard-surfaced roads for a short distance and at low speed. Also, the wheels, axles, power train, steering and brakes must all be in good condition.

- Do not use the tow hooks to pull a vehicle out of mud, sand or other conditions from which the vehicle cannot be driven out under its own power.
- Avoid towing a vehicle heavier than the vehicle doing the towing.
- The drivers of both vehicles should communicate with each other frequently.

CAUTION

- Attach a towing strap to the tow hook.
- Using a portion of the vehicle other than the tow hooks for towing may damage the body of your vehicle.

- Use only a cable or chain specifically intended for use in towing vehicles. Securely fasten the cable or chain to the towing hook provided.
- Accelerate or decelerate the vehicle in a slow and gradual manner whilst maintaining tension on the tow rope or chain to start or drive the vehicle, otherwise tow hooks and the vehicle may be damaged.

- Before emergency towing, check if the hook is not broken or damaged.
- Fasten the towing cable or chain securely to the hook.
- Do not jerk the hook. Apply it steadily and with even force.
- To avoid damaging the hook, do not pull from the side or at a vertical angle. Always pull straight ahead.

WARNING

Use extreme caution when towing the vehicle.

- Avoid sudden starts or erratic driving manoeuvres which would place excessive stress on the emergency towing hook and towing cable or chain. The hook and towing cable or chain may break and cause serious injury or damage.
- If the disabled vehicle is unable to be moved, do not forcibly con-

tinue the towing. We recommend that you contact an authorised Kia dealer or a commercial tow truck service for assistance.

- Tow the vehicle as straight ahead as possible.
- Keep away from the vehicle during towing.

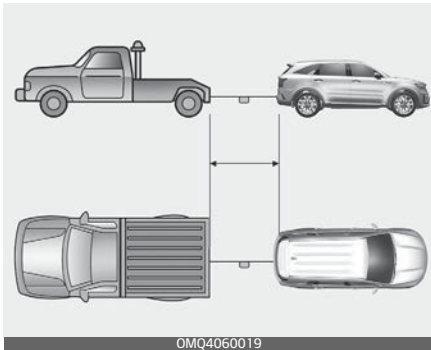
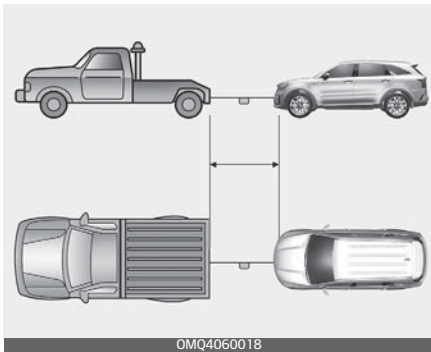

- Use a towing strap less than 5 m (16 feet) long. Attach a white or red cloth (about 30 cm (12 inches) wide) in the middle of the strap for easy visibility.
- Drive carefully so that the towing strap is not loosened during towing.

- The driver must be in the vehicle for steering and braking operations when the vehicle is towed and passengers other than the driver must not be allowed to be on board.

Emergency towing precautions

- Turn the ignition switch or the ENGINE START/STOP button to the ACC position so the steering wheel is not locked.
- Shift the gear to N (Neutral).
- Release the parking brake.
- Press the brake pedal with more force than normal since you will have reduced brake performance.
- More steering effort will be required because the power steering system will be disabled.
- If you are driving down a long hill, the brakes may overheat and brake performance will be reduced. Stop often and let the brakes cool off.
- To avoid serious damage to the automatic transmission, limit the vehicle speed to 15 km/h (10 mph) and drive less than 1.5 km (1 mile) when towing.

CAUTION

Automatic transmission

- If the car is being towed with all four wheels on the ground, it can be towed only from the front. Be sure that the transmission is in

neutral. Be sure the steering is unlocked by placing the ignition switch in the ACC position. A driver must be in the towed vehicle to operate the steering and brakes.

- Before towing, check the automatic transmission for fluid leaks under your vehicle. If the automatic transmission fluid is leaking, flatbed equipment or a towing dolly must be used.
-

Emergency commodity (if equipped)

There are some emergency commodities in the vehicle to help you respond to the emergency situation.

First aid kit (if equipped)

There are some items such as scissors, bandage and adhesive tape and etc. in the kit to give first aid to an injured person.

Triangle reflector (if equipped)

Place the triangle reflector on the road to warn oncoming vehicles during emergencies, such as when the vehicle is parked by the roadside due to any problems.

Tyre pressure gauge (if equipped)

Tyres normally lose some air in day-to-day use, and you may have to add a few pounds of air periodically and it is not usually a sign of a leaking tyre, but of normal wear. Always check tyre pressure when the tyres are cold because tyre pressure increases with temperature.

To check the tyre pressure, take the following steps;

1. Unscrew the inflation valve cap that is located on the rim of the tyre.
2. Press and hold the gauge against the tyre valve. Some air will escape as you begin and more will

- escape if you don't press the gauge in firmly.
- 3. A firm non-leaking push will activate the gauge.
- 4. Read the tyre pressure on the gauge to know whether the tyre pressure is low or high.
- 5. Adjust the tyre pressures to the specified pressure. Refer to "Tyres and wheels" on page 8-50.
- 6. Reinstall the inflation valve cap.

Pan-European eCall system (if equipped)

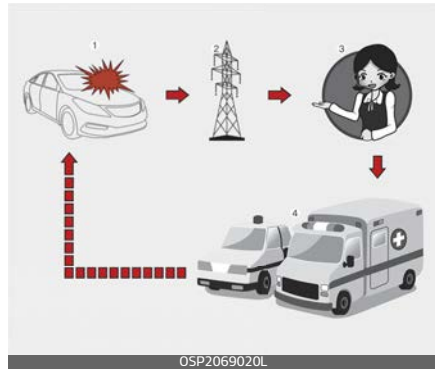

- 1. Road accident
- 2. Wireless network
- 3. Public Safety Answering Point (PSAP)
- 4. Rescue

The car is equipped with a device*¹ connected with the Pan-European eCall system for making emergency call to response teams. The Pan-European eCall system is an automatic emergency call service made in event of a traffic accident or other*² accidents on the roads of Europe. (only in countries with regulation on this system)

The system allows contacting with an officer of the single duty dispatch service in case of accidents on the roads of Europe. (only in countries with regulation on this system)

The Pan-European eCall system given conditions, stated in the

Owner's Manual as well as Warranty and Service book transmits data to the Public Safety Answering Point (PSAP) including such information as vehicle location, vehicle type, VIN (vehicle identification number of the car).

Once the data which is stored in the Pan-European eCall system is delivered to the rescue centre to assist the driver and passengers with proper rescue operations, the data will be deleted after rescue operation is completed.

*1. Pan-European eCall device in the Owner's Manual means equipment, installed in the car, which provides connection with the Pan-European eCall system.

*2. "Other accidents" mean any accidents on the roads of Europe (only in countries with regulation on this system) resulted in injured people and/or necessity of provision of assistance. In case of registration of any accident, it is necessary to stop a vehicle, press button SOS (location of the button is specified on the picture in the chapter "Pan-European eCall (IF EQUIPPED)") of the Owner's Manual. When making a call, the system gathers information about the car (from which a call was made), after which connects the car with an officer of the Public Safety

Answering Point (PSAP) to tell about the reason of the emergency call.

Description of the ecall in-vehicle system

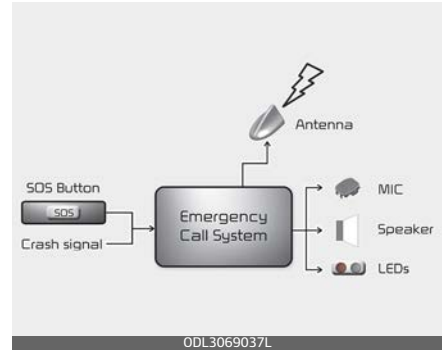

Overview of the 112-based eCall in-vehicle system, its operation and functionalities: refer to this section. The 112-based eCall service is a public service of general interest and is accessible free of charge.

The 112-based eCall in-vehicle system is activated by default. It is activated automatically by means of in-vehicle sensors in the event of a severe accident.

It will also be triggered automatically when the vehicle is equipped with a TPS system which does not function in the event of a severe accident.

The 112-based eCall in-vehicle system can also be triggered manually, if needed. Instructions for manual



activation of the system: refer to this section.

In the event of a critical system failure that would disable the 112-based eCall in-vehicle system, the following warning will be given to the occupants of the vehicle: refer to this section.

Information on data processing

Any processing of personal data through the 112-based eCall in-vehicle system shall comply with the personal data protection rules provided for in Directives 95/46/EC (1) and 2002/58/EC (2) of the European Parliament and of the Council, and in particular, shall be based on the necessity to protect the vital interests of the individuals in accordance with Article 7(d) of Directive 95/46/EC (3).

Processing of such data is strictly limited to the purpose of handling the emergency eCall to the single European emergency number 112.

Types of data and its recipients

The 112-based eCall in-vehicle system may collect and process only the following data:

- Vehicle Identification Number
- Vehicle type (passenger vehicle or light commercial vehicle)

- Vehicle propulsion storage type (petrol/diesel/CNG/LPG/electric/hydrogen)
- Vehicle recent locations and direction of travel
- Log file of the automatic activation of the system and its timestamp
- Any additional data (if applicable): Not applicable

Recipients of data processed by the 112-based eCall in-vehicle system are the relevant public safety answering points designated by the respective public authorities of the country on which territory they are located, to first receive and handle eCalls to the single European emergency number 112. Additional information (if available): Not applicable

1. Directive 95/46/EC of the European Parliament and of the Council of 24 October 1995 on the protection of individuals with regard to the processing of personal data and on the free movement of such data (OJ L 281, 23.11.1995, p. 31).
2. Directive 2002/58/EC of the European Parliament and of the Council of 12 July 2002 concerning the processing of personal data and the protection of privacy in the electronic communications sector (Directive on privacy and electronic communications) (OJ L 201, 31.7.2002, p. 37).

3. Directive 95/46/EC is repealed by Regulation (EU) 2016/679 of the European Parliament and of the Council of 27 April 2016 on the protection of natural persons with regard to the processing of personal data and on the free movement of such data (General Data Protection Regulation) (OJ L 119, 4.5.2016, p. 1). The Regulation applies from 25 May 2018.

Arrangements for data processing

The 112-based eCall in-vehicle system is designed in such a way as to ensure that the data contained in the system memory is not available outside the system before an eCall is triggered. Additional remarks (if any): Not applicable

The 112-based eCall in-vehicle system is designed in such a way as to ensure that it is not traceable and not subject to any constant tracking in its normal operation status. Additional remarks (if any): Not applicable

The 112-based eCall in-vehicle system is designed in such a way as to ensure that data in the system internal memory is automatically and continuously removed.

The vehicle location data is constantly overwritten in the internal memory of the system so as always to keep maximum of the last three

up-to-date locations of the vehicle necessary for the normal functioning of the system.

The log of activity data in the 112-based eCall in-vehicle system is kept for no longer than necessary for attaining the purpose of handling the emergency eCall and in any case not beyond 13 hours from the moment an emergency eCall was initiated. Additional remarks (if any): Not applicable

Modalities for exercising data subject's rights

The data subject (the vehicle's owner) has a right of access to data and as appropriate to request the rectification, erasure or blocking of data, concerning him or her, the processing of which does not comply with the provisions of Directive 95/46/EC. Any third parties to whom the data have been disclosed have to be notified of such rectification, erasure or blocking carried out in compliance with this Directive, unless it proves impossible or involves a disproportionate effort.

The data subject has a right to complain to the competent data protection authority if he or she considers that his or her rights have been infringed as a result of the processing of his or her personal data.

Contact service responsible for handling access requests (if any): Not applicable

Pan-European eCall System



Elements of the Pan-European eCall system, installed in passenger compartment:

- 1. Microphone
- 2. SOS button
- 3. LED

SOS button: the driver/passenger makes an emergency call to the single duty dispatch service by pressing the button.

LED: The red and green LED illuminates for 3 seconds when the ignition switch is in the ON position. After that they will switch off at normal operation of the system.

If there are some problems in the system, the LED remains in red.

Automatic accident reporting

- 1. System operation in the event of a traffic accident



- 2. Connection with the Public Safety Answering Point (PSAP)



- 3. Emergency services



The Pan-European eCall device automatically makes an emergency call to the Public Safety Answering Point (PSAP) for proper rescuing operations in event of car accident.

For proper emergency services and support the Pan-European eCall system automatically transmits the accident data to the Public Safety Answering Point (PSAP) when a traffic accident is detected.

In this case, the emergency call cannot be hung up by pressing the SOS

button and the Pan-European eCall system remains connected until the emergency service officer, receiving the call, disconnects the emergency call.

In minor traffic accidents the Pan-European eCall system may not execute an emergency call. However, an emergency call may be made manually by pressing the SOS button.

CAUTION

Operation of the system is impossible in case of absence of mobile transmission and GPS and Galileo signals.

Manual accident reporting



The driver or passenger manually can make an emergency call in the Public Safety Answering Point (PSAP), by pressing SOS button to call the necessary emergency services.

A call to the emergency services through the Pan-European eCall system can be cancelled by pressing the SOS button again only before the call connection.

After activation of emergency call in the manual mode (for proper emergency services and support), the Pan-European eCall system automatically transmits the road accident data/or data on other accident to the officer of the Public Safety Answering Point (PSAP) (during emergency call) by pressing the SOS button.

If the driver or passenger accidentally presses the SOS button, it can be cancelled by pressing the button again in 3 seconds. It can't be cancelled after that.

In case of road accident or other accident for activation of emergency call in manual mode it is necessary:

1. Stop the car in accordance with traffic rules to ensure safety to yourself and other participants of road traffic;
2. Press the SOS button, when pressing the button SOS registration of the device in the wireless telephonic communication networks is carried out, minimum data set about car and its location is collected in accordance with of the technical requirements of the device.
After that connection with the officer of the Pan-European eCall system is made for clearing up reasons (conditions) of the emergency call.
3. After clearing up reasons of the emergency call, the officer of the Public Safety Answering Point (PSAP) sends emergency services and completes the emergency call.

If the emergency call is not carried out in accordance with the procedure, mentioned above, the emergency call will be considered as erroneous.

⚠ WARNING

Emergency power supply of the Pan-European eCall system from the battery

- The Pan-European eCall system battery supplies power during 1 hour in case main power source of the vehicle is cut off due to the

collision during the emergency situations.

- The Pan-European eCall system battery should be replaced every 3 years.

LED illumination in red (system malfunction)

If red LED illuminates in normal driving conditions, this can indicate malfunction of the Pan-European eCall system. Please, have the Pan-European eCall system checked at an authorised Kia dealer/service partner. Otherwise correct operation of the Pan-European eCall system device, installed in your car is not guaranteed. Owner of the car incurs liability for consequences, occurred as a result of nonobservance of conditions, mentioned above.

Arbitrary Removal or Modification

The Pan-European eCall system calls emergency services for assistance. Thus, any arbitrary removal or changes to the Pan-European eCall system settings may affect your driving safety. Also, it may even make an erroneous emergency call to the Public Safety Answering Point (PSAP). Thereby, we kindly ask you not to make any changes by yourself or by the third parties in the settings of the equipment of the Pan-European eCall system, installed in your car.

Engine compartment	8-5
Maintenance services.....	8-6
• Owner's responsibility	8-6
• Owner maintenance precautions.....	8-6
Owner maintenance	8-7
• Owner maintenance schedule	8-7
Scheduled maintenance service	8-9
• Scheduled maintenance service precaution	8-9
Explanation of scheduled maintenance items.....	8-25
• Engine oil and filter	8-25
• Hybrid Starter & Generator (HSG) belt.....	8-25
• Fuel filter	8-25
• Fuel lines, fuel hoses and connections.....	8-25
• Vapour hose and fuel filler cap	8-25
• Vacuum crankcase ventilation hoses	8-25
• Air cleaner filter	8-26
• Spark plugs.....	8-26
• Cooling system.....	8-26
• Coolant/inverter coolant	8-26
• Automatic transmission fluid	8-26
• Brake hoses and lines	8-27
• Brake fluid	8-27
• Brake discs, pads and calipers.....	8-27
• Suspension mounting bolts	8-27
• Steering gear box, linkage & boots/lower arm ball joint.....	8-27
• Drive shafts and boots	8-27
• Air conditioning refrigerant	8-27
• Propeller shaft	8-28

8 Maintenance

• Checking fluid levels	8-28
Engine oil and filter	8-28
• Checking the engine oil level.....	8-28
• Changing the engine oil and filter	8-29
Coolant	8-31
• Checking the engine coolant level.....	8-31
• Checking the inverter coolant level (HEV)	8-33
• Checking the inverter coolant level (PHEV).....	8-35
Hybrid starter & generator (HSG) belt	8-36
• Checking the Hybrid Starter & Generator (HSG) belt.....	8-36
Brake fluid	8-37
• Checking the brake fluid level.....	8-37
Washer fluid	8-38
• Checking the washer fluid level.....	8-38
Air cleaner filter	8-39
• Replacing air cleaner filter	8-39
Climate control air filter	8-41
• Filter inspection	8-41
Wiper blades	8-42
• Blade inspection.....	8-42
• Blade replacement.....	8-43
• Replacing rear wiper blade.....	8-44
Battery	8-46
• For best battery service.....	8-46
• Battery capacity label.....	8-48
• Battery recharging	8-48
• Reset items	8-49
Tyres and wheels	8-50

• Tyre care	8-50
• Recommended cold tyre inflation pressures.....	8-50
• Checking tyre inflation pressure.....	8-51
• Tyre rotation	8-52
• Wheel alignment and tyre balance.....	8-53
• Tyre replacement	8-54
• Wheel replacement	8-55
• Tyre traction	8-55
• Tyre maintenance	8-56
• Tyre sidewall labelling.....	8-56
• Low aspect ratio tyre	8-59
Fuses.....	8-61
• Inner panel fuse replacement	8-63
• Engine compartment fuse replacement	8-64
• Fuse/relay panel description	8-65
Light bulbs.....	8-77
• Bulb replacement precaution	8-77
• Light bulb position (Front)	8-79
• Light bulb position (Rear).....	8-80
• Light bulb position (Side).....	8-81
• Replacing headlamp (Low beam/High beam), position lamp/daytime running lamp, turn signal lamp (LED type)	8-81
• Replacing front turn signal lamp (Bulb type)	8-82
• Replacing front fog lamp (LED type)	8-82
• Replacing side repeater lamp (LED type).....	8-83
• Replacing stop and tail lamp (Bulb type).....	8-83
• Replacing rear turn signal lamp (Bulb type)	8-84
• Replacing rear turn signal lamp, stop and tail lamp (LED type)	8-85

8 Maintenance

- Replacing reversing lamp (bulb type).....8-86
- Replacing rear fog lamp (LED type)8-87
- Replacing high mounted stop lamp (LED type)8-87
- Replacing license plate lamp (LED type).....8-87
- Replacing map lamp (Bulb type)8-88
- Replacing map lamp (LED type)8-88
- Replacing room lamp (Bulb type)8-89
- Replacing personal lamp (LED type).....8-89
- Replacing vanity mirror lamp (Bulb type)8-90
- Replacing glove box lamp8-90
- Replacing luggage lamp (Bulb type)8-91
- Replacing luggage lamp (LED type)8-91
- Headlamp and front fog lamp aiming8-92
- Appearance care8-97**
 - Exterior care.....8-97
 - Interior care8-102
- Emission control system8-105**
 - Procedure for entering forced engine activation mode8-108

Maintenance

Engine compartment

Smartstream G1.6 T-GDi HEV

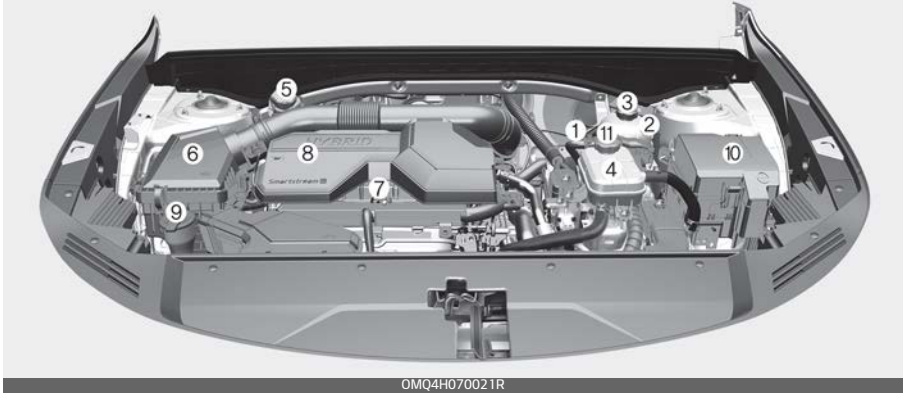

Smartstream G1.6 T-GDi PHEV

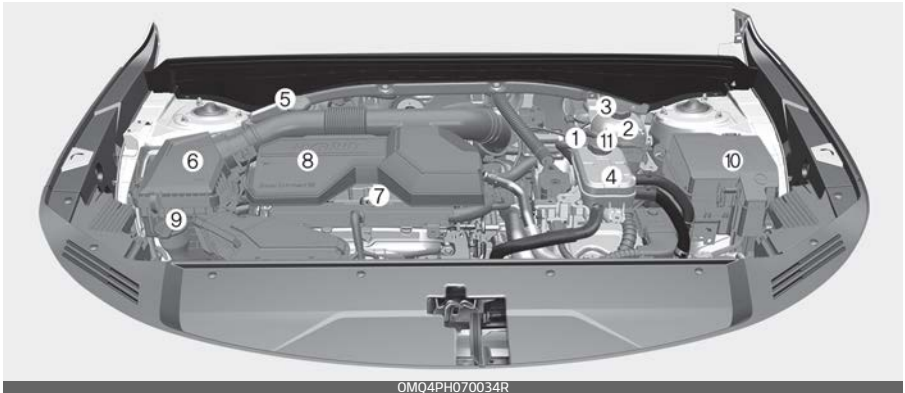

* The actual engine room in the vehicle may differ from the illustration.

- | | |
|----------------------------------|--------------------------------------|
| 1. Electronic Control Unit (ECU) | 8. Engine oil filler cap |
| 2. Engine coolant reservoir | 9. Windscreen washer fluid reservoir |
| 3. Engine coolant reservoir cap | 10. Fuse box |
| 4. Inverter coolant reservoir | 11. Inverter coolant reservoir cap |
| 5. Brake fluid reservoir | |
| 6. Air cleaner | |
| 7. Engine oil dipstick | |

Maintenance services

You should exercise the utmost care to prevent damage to your vehicle and injury to yourself whenever performing any maintenance or inspection procedures.

Inadequate, incomplete or insufficient servicing may result in operational problems with your vehicle that could lead to vehicle damage, an accident, or personal injury.

Owner's responsibility

* NOTICE

Maintenance Service and Record Retention are the owner's responsibility.

Have your vehicle serviced by a professional workshop. Kia recommends to visit an authorised Kia dealer/service partner.

You should retain documents that show proper maintenance has been performed on your vehicle in accordance with the scheduled maintenance service charts shown on the following pages.

You need this information to establish your compliance with the servicing and maintenance requirements of your vehicle warranties.

Detailed warranty information is provided in your Warranty & Maintenance book.

Repairs and adjustments required as a result of improper maintenance or a lack of required maintenance are not covered when your vehicle is covered by warranty.

Owner maintenance precautions

Improper or incomplete service may result in problems. This section gives instructions only for the maintenance items that are easy to perform.

* NOTICE

Improper owner maintenance during the warranty period may affect warranty coverage. For details, read the separate Warranty & Maintenance book provided with the vehicle. If you're unsure about any servicing or maintenance procedure, have the system serviced by a professional workshop. Kia recommends to visit an authorised Kia dealer/service partner.

WARNING

Maintenance work

- Performing maintenance work on a vehicle can be dangerous. You can be seriously injured whilst performing some maintenance procedures. If you lack sufficient knowledge and experience or the proper tools and equipment to do the work, have the system serviced by a professional workshop. Kia recommends to visit an authorised Kia dealer/service partner.
- Working under the bonnet with the engine running is dangerous. It becomes even more dangerous when you wear jewelry or loose clothing. These can become entangled in moving parts and result in injury. Therefore, if you must run the engine whilst working under the bonnet, make certain that you remove all jewelry (especially rings, bracelets, watches, and necklaces) and all neckties, scarves, and similar loose clothing before getting near the engine or cooling fans.

Owner maintenance

The following lists are vehicle checks and inspections that should be performed at the frequencies indicated to help ensure safe, dependable operation of your vehicle.

Any adverse conditions should be brought to the attention of your dealer as soon as possible.

These Owner Maintenance Checks are generally not covered by warranties and you may be charged for labour, parts and lubricants used.

Owner maintenance schedule

When you stop for fuel:

- Check the coolant level in the coolant reservoir.
- Check the windscreen washer fluid level.
- Look for low or under-inflated tyres.

WARNING

Be careful when checking your engine coolant level when the engine is hot. Scalding hot coolant and steam may blow out under pressure. This could cause burns or other serious injury.

Whilst operating your vehicle:

- Note any changes in the sound of the exhaust or any smell of exhaust fumes in the vehicle.
- Check for vibrations in the steering wheel. Notice any increased steering effort or looseness in the steering wheel, or change in its straightahead position.
- Notice if your vehicle constantly turns slightly or "pulls" to one side when travelling on smooth, level road.
- When stopping, listen and check for unusual sounds, pulling to one side, increased brake pedal travel or "hard-to-push" brake pedal.
- If any slipping or changes in the operation of your transmission occurs, check the transmission fluid level.
- Check the parking brake.
- Check for fluid leaks under your vehicle (water dripping from the air conditioning system during or after use is normal).

At least monthly:

- Check the coolant level in the engine coolant reservoir.
- Check the operation of all exterior lights, including the stoplights, turn signals and hazard warning flashers.
- Check the inflation pressures of all tyres including the spare for tyres

that are worn, show uneven wear, or are damaged.

- Check for loose wheel lug nuts.

At least twice a year (i.e., every Spring and Fall):

- Check the radiator, heater and air conditioning hoses for leaks or damage.
- Check the windscreen washer spray and wiper operation. Clean the wiper blades with clean cloth dampened with washer fluid.
- Check the headlight alignment.
- Check the muffler, exhaust pipes, shields and clamps.
- Check the lap/shoulder belts for wear and function.

At least once a year:

- Clean the body and door drain holes.
- Lubricate the door hinges and checks, and bonnet hinges.
- Lubricate the door and bonnet locks and latches.
- Lubricate the door rubber weatherstrips.
- Check the air conditioning system.
- Inspect and lubricate the automatic transmission linkage and controls.
- Clean the battery and terminals.
- Check the brake fluid level.

Scheduled maintenance service

Scheduled maintenance service precaution

Follow the Normal Maintenance Schedule if the vehicle is usually operated where none of the following conditions apply. If any of the following conditions apply, follow the Maintenance Under Severe Usage Conditions.

- Repeated driving short distance of less than 8 km (5 miles) in normal temperature or less than 16 km (10 miles) in freezing temperature
- Extensive engine idling or low speed driving for long distances
- Driving on rough, dusty, muddy, unpaved, gravelled or salt-spread roads
- Driving in areas using salt or other corrosive materials or in very cold weather
- Driving in heavy dust condition
- Driving in heavy traffic area
- Driving on uphill, downhill, or mountain road repeatedly
- Using for towing or camping and driving with loading on the roof.
- Driving as a patrol car, taxi, other commercial use of vehicle towing
- Frequently driving under high speed or rapid acceleration/deceleration.
- Frequently driving in stop-and-go condition

- Engine oil usage which is not recommended (Mineral type, Semi-synthetic, Lower grade spec, etc.)

If your vehicle is operated in any of the prior listed conditions, you should inspect, replace or refill more frequently, using the severe usage maintenance schedule instead of the normal usage maintenance schedule.

Normal maintenance schedule – For Australia and New Zealand

The following maintenance services must be performed to ensure good emission control and performance. Keep receipts for all vehicle emission services to protect your warranty. Where both mileage and time are shown, the frequency of service is determined by whichever occurs first.

NO.	ITEM	REMARK
*1	Engine oil and engine oil filter	<ul style="list-style-type: none"> As it is normal for engine oil to be consumed during driving, the engine oil level should be checked on regular basis. The engine oil change interval for normal operating conditions is based on the use of the recommended engine specification. If the recommended engine oil specification is not used, then replace the engine oil according to the maintenance schedule under severe operating conditions.
*2	Coolant (Engine)	When adding coolant, use only deionised water or soft water for your vehicle and never mix hard water in the coolant filled at the factory. An improper coolant mixture can result in serious malfunction or engine damage.
*3	Coolant (HEV Inverter)	When adding coolant, use only deionised water or soft water for your vehicle and never mix hard water in the coolant filled at the factory. An improper coolant mixture can result in serious malfunction or engine damage.
*4	Coolant (PHEV Inverter)	Recommend that the coolant be replaced by an authorised Kia dealer/service partner.
*5	HSG (Hybrid Starter & Generator) belt	Inspect HSG belt for evidence of cuts, cracks, excessive wear or oil saturation and replace if necessary.
*6	Spark plug	For your convenience, it can be replaced prior to it's interval when you do maintenance of other items.
*7	Differential oil (Rear) (AWD)	Differential oil should be changed anytime it has been submerged in water.
*8	Transfer case oil (AWD)	Transfer case oil should be changed anytime it has been submerged in water.
*9	Fuel additives	<p>Kia recommends that you use unleaded petrol which has an octane rating of RON (Research Octane Number) 95 / AKI (Anti Knock Index) 91 or higher (for Europe) or Octane Rating of RON (Research Octane Number) 91 / AKI (Anti-Knock Index) 87 or higher (except Europe).</p> <p>For customers who do not use good quality petrols including fuel additives regularly, and have problems starting or the engine does not run smoothly, one bottle of additives added to the fuel tank when the engine oil is replaced. Additives are available from a professional workshop along with information on how to use them. Kia recommends to visit an authorised Kia dealer/service partner. Do not mix other additives.</p>

I: Inspect and if necessary, adjust, correct, clean or replace.

R: Replace or change.

Normal Maintenance Schedule								
Number of months or driving distance, whichever comes first								
Months	12	24	36	48	60	72	84	96
Km×1,000	10	20	30	40	50	60	70	80
Engine oil and engine oil filter *1	R	R	R	R	R	R	R	R
Coolant (Engine) *2	At first, Replace 210,000 km or 120 months After that, Replace every 30,000 km or 24 months							
Coolant (Inverter)	HEV*3 At first, Replace 210,000 km (140,000 miles) or 120 months After that, Replace every 30,000 km (20,000 miles) or 24 months							
	PHEV*4 Replace every 60,000 km (40,000 miles) or 36 months							
HSG (Hybrid Starter & Generator) belt *5	Inspect every 10,000 km or 12 months Replace every 100,000 km or 48 months							
Spark plugs *6	Unleaded Replace every 70,000 km							
Automatic transmission (AT) fluid	No check, No service required							
Drive shaft and boots	-	I	-	I	-	I	-	I
Propeller shaft (AWD) (if equipped)	-	I	-	I	-	I	-	I
Rear differential oil (AWD)*7 (if equipped)	-	-	-	I	-	-	-	I
Transfer case oil (AWD)*8 (if equipped)	-	-	-	I	-	-	-	I
Fuel additives *9	Add every 10,000 km or 12 months							
Fuel lines, hoses and connections	-	-	-	I	-	-	-	I
Fuel tank air filter (if equipped)	-	I	-	R	-	I	-	R
Vapour hose and fuel filler cap	-	-	-	I	-	-	-	I
Air cleaner filter	I	I	R	I	I	R	I	I
Intercooler, in/out hose, air intake hose	I	I	I	I	I	I	I	I
Exhaust system	-	I	-	I	-	I	-	I
Cooling system	-	-	-	I	-	I	-	I
Air conditioner compressor/refrigerant	I	I	I	I	I	I	I	I
Climate control air filter	I	R	I	R	I	R	I	R
Brake discs and pads	-	I	-	I	-	I	-	I
Brake lines, hoses and connections	-	I	-	I	-	I	-	I
Brake fluid	I	R	I	R	I	R	I	R
Steering gear rack, linkage and boots	I	I	I	I	I	I	I	I
Suspension ball joints	I	I	I	I	I	I	I	I
Tyre (pressure & tread wear)	I	I	I	I	I	I	I	I

Normal Maintenance Schedule								
Number of months or driving distance, whichever comes first								
Months	12	24	36	48	60	72	84	96
Km×1,000	10	20	30	40	50	60	70	80
Battery (12V) condition	-		-		-		-	

- Fuel filter (petrol engine): The fuel filter is considered to be maintenance free but periodic inspection is recommended for this maintenance schedule depends on fuel quality.
 - If there are some important safety matters like fuel flow restriction, surging, loss of power, hard starting problem etc, replace the fuel filter immediately regardless of maintenance schedule and consult an authorised Kia dealer/service partner for details.

Maintenance under severe usage conditions – For Australia and New Zealand

I: Inspect and if necessary, adjust, correct, clean or replace.

R: Replace or change.

MAINTENANCE ITEM		MAINTENANCE OPERATION	MAINTENANCE INTERVALS	DRIVING CONDITION
Engine oil and engine oil filter		R	Every 5,000 km or 6 months	A, B, C, D, E, F, G, H, I, J, K, L
HSG (Hybrid Starter & Generator) belt		R	Every 50,000 km or 24 months	B, C, D, E, I, K
		I	Every 10,000 km or 12 months	
Spark plugs	Unleaded	R	Replace more frequently depending on the condition	A, B, F, G, H, I, K
Automatic transmission (AT) fluid		R	Every 90,000 km	A, C, F, G, H, I, J, K
Drive shaft and boots		I	Inspect more frequently depending on the condition	C, D, E, F, G, H, I, J
Propeller shaft (AWD) (if equipped)		I	Inspect more frequently depending on the condition	C, D, E, F, G, H, I, J
Rear differential oil (AWD) (if equipped)		R	Every 120,000 km	C, E, G, H, I, J
Transfer case oil (AWD) (if equipped)		R	Every 120,000 km	C, E, G, H, I, J
Air cleaner filter		R	Replace more frequently depending on the condition	C, E
Climate control air filter		R	Replace more frequently depending on the condition	C, E, G
Brake discs, pads and calipers		I	Inspect more frequently depending on the condition	C, D, E, G, H, I, J, K
Steering gear rack, linkage and boots		I	Inspect more frequently depending on the condition	C, D, E, F, G
Suspension ball joints		I	Inspect more frequently depending on the condition	C, D, E, G, H, I

Severe driving conditions

A: Repeatedly driving short distance of less than 8 km in normal temperature or less than 16 km in freezing temperature.

B: Extensive engine idling or low speed driving for long distances.

C: Driving on rough, dusty, muddy, unpaved, gravelled or saltspread roads.

D: Driving in areas using salt or other corrosive materials or in very cold weather

E: Driving in heavy dust condition.

F: Driving in heavy traffic area.

G: Driving on uphill, downhill, or mountain roads repeatedly.

H: Using for towing or camping and driving with loading on the roof.

I: Driving for patrol car, taxi, other commercial use of vehicle towing.

J: Frequently driving under high speed or rapid acceleration/deceleration.

K: Frequently driving in stop-and-go conditions.

L: Engine oil usage which is not recommended (Mineral type, Semi-synthetic, Lower grade spec, etc.)

Normal maintenance schedule - for Europe

The following maintenance services must be performed to ensure good emission control and performance. Keep receipts for all vehicle emission services to protect your warranty. Where both mileage and time are shown, the frequency of service is determined by whichever occurs first.

NO.	ITEM	REMARK
*1	Engine oil and engine oil filter	<ul style="list-style-type: none"> As it is normal for engine oil to be consumed during driving, the engine oil level should be checked on regular basis. The engine oil change interval for normal operating conditions is based on the use of the recommended engine specification. If the recommended engine oil specification is not used, then replace the engine oil according to the maintenance schedule under severe operating conditions.
*2	Coolant (Engine)	When adding coolant, use only deionized water or soft water for your vehicle and never mix hard water in the coolant filled at the factory. An improper coolant mixture can result in serious malfunction or engine damage.
*3	Coolant (HEV Inverter)	When adding coolant, use only deionized water or soft water for your vehicle and never mix hard water in the coolant filled at the factory. An improper coolant mixture can result in serious malfunction or engine damage.
*4	Coolant (PHEV Inverter)	Recommend that the coolant be replaced by an authorised Kia dealer/service partner.
*5	HSG (Hybrid Starter & Generator) belt	Inspect HSG belt for evidence of cuts, cracks, excessive wear or oil saturation and replace if necessary.
*6	Spark plug	For your convenience, it can be replaced prior to it's interval when you do maintenance of other items.
*7	Differential oil (Rear) (AWD)	Differential oil should be changed anytime it has been submerged in water.
*8	Transfer case oil (AWD)	Transfer case oil should be changed anytime it has been submerged in water.
*9	Fuel additives	Kia recommends that you use unleaded petrol which has an octane rating of RON (Research Octane Number) 95 / AKI (Anti Knock Index) 91 or higher (for Europe) or Octane Rating of RON (Research Octane Number) 91 / AKI (Anti-Knock Index) 87 or higher (except Europe). For customers who do not use good quality petrols including fuel additives regularly, and have problems starting or the engine does not run smoothly, one bottle of additives should be added to the fuel tank when the engine oil is replaced. Additives are available from a professional workshop along with information on how to use them. Kia recommends to visit an authorised Kia dealer/service partner. Do not mix other additives.

I: Inspect and if necessary, adjust, correct, clean or replace.

R: Replace or change.

Number of months or driving distance, whichever comes first								
Months	24	48	72	96	120	144	168	192
Miles × 1,000	20	40	60	80	100	120	140	160
Km × 1,000	30	60	90	120	150	180	210	240
Engine oil and engine oil filter* ¹	Replace every 15,000 km (10,000 miles) or 12 months							
Coolant (Engine)* ²	At first, Replace 210,000 km (140,000 miles) or 120 months After that, Replace every 30,000 km (20,000 miles) or 24 months							
Coolant (Inverter)	HEV* ³	At first, Replace 210,000 km (140,000 miles) or 120 months After that, Replace every 30,000 km (20,000 miles) or 24 months						
	PHEV* ⁴	Replace every 60,000 km (40,000 miles) or 36 months						
HSG (Hybrid Starter & Generator) belt* ⁵	Inspect every 15,000 km (10,000 miles) or 12 months Replace every 105,000 km (70,000 miles) or 48 months							
Spark plugs* ⁶	Unleaded	Replace every 75,000 km (50,000 miles)						
Automatic transmission (AT) fluid	No check, No service required							
Drive shaft and boots	I	I	I	I	I	I	I	I
Propeller shaft (AWD) (if equipped)	I	I	I	I	I	I	I	I
Rear differential oil (AWD)* ⁷ (if equipped)	-	I	-	I	-	I	-	I
Transfer case oil (AWD)* ⁸ (if equipped)	-	I	-	I	-	I	-	I
Fuel additives* ⁹	Add every 15,000 km (10,000 miles) or 12 months							
Fuel lines, hoses and connections	-	I	-	I	-	I	-	I
Fuel tank air filter	-	I	-	I	-	I	-	I
Vapour hose and fuel filler cap	-	I	-	I	-	I	-	I
Air cleaner filter	I	R	I	R	I	R	I	R
Intercooler, in/out hose, air intake hose	Inspect every 10,000 km (6,500 miles) or 12 months							
Exhaust system	I	I	I	I	I	I	I	I
Cooling system	-	I	I	I	I	I	I	I
Air conditioner compressor/ refrigerant	I	I	I	I	I	I	I	I
Climate control air filter	R	R	R	R	R	R	R	R
Brake discs and pads	I	I	I	I	I	I	I	I
Brake lines, hoses and connections	I	I	I	I	I	I	I	I

Number of months or driving distance, whichever comes first								
Months	24	48	72	96	120	144	168	192
Miles × 1,000	20	40	60	80	100	120	140	160
Km × 1,000	30	60	90	120	150	180	210	240
Brake fluid	R	R	R	R	R	R	R	R
Steering gear rack, linkage and boots	I	I	I	I	I	I	I	I
Suspension ball joints	I	I	I	I	I	I	I	I
Tyre (pressure & tread wear)	I	I	I	I	I	I	I	I
Battery (12V) condition	I	I	I	I	I	I	I	I
Pan-European eCall system battery (if equipped)	Replace every 3 years							

Maintenance under severe usage conditions- for Europe

I: Inspect and if necessary, adjust, correct, clean or replace.

R: Replace or change.

Maintenance item		Maintenance operation	Maintenance intervals	Driving condition
Engine oil and engine oil filter		R	Every 7,500 km (5,000 miles) or 6 months	A, B, C, D, E, F, G, H, I, J, K, L
HSG (Hybrid Starter & Generator) belt		R	Every 45,000 km (30,000 miles) or 24 months	B, C, D, E, I, K
		I	Every 15,000 km (10,000 miles) or 12 months	
Spark plugs	Unleaded	R	Replace more frequently depending on the condition	A, B, F, G, H, I, K
Automatic transmission (AT) fluid		R	Every 90,000 km (60,000 miles)	A, C, F, G, H, I, J, K
Drive shaft and boots		I	Inspect more frequently depending on the condition	C, D, E, F, G, H, I, J
Propeller shaft (AWD) (if equipped)		I	Inspect more frequently depending on the condition	C, D, E, F, G, H, I, J
Rear differential oil (AWD) (if equipped)		R	Every 120,000 km (80,000 miles)	C, E, G, H, I, J
Transfer case oil (AWD) (if equipped)		R	Every 120,000 km (80,000 miles)	C, E, G, H, I, J
Air cleaner filter		R	Replace more frequently depending on the condition	C, E
Climate control air filter		R	Replace more frequently depending on the condition	C, E, G
Brake discs, pads and calipers		I	Inspect more frequently depending on the condition	C, D, E, G, H, I, J, K
Steering gear rack, linkage and boots		I	Inspect more frequently depending on the condition	C, D, E, F, G
Suspension ball joints		I	Inspect more frequently depending on the condition	C, D, E, G, H, I

Severe driving conditions

- A: Repeatedly driving short distance of less than 8 km (5 miles) in normal temperature or less than 16 km (10 miles) in freezing temperature.
- B: Extensive engine idling or low speed driving for long distances.
- C: Driving on rough, dusty, muddy, unpaved, gravelled or saltspread roads.
- D: Driving in areas using salt or other corrosive materials or in very cold weather
- E: Driving in heavy dust condition.
- F: Driving in heavy traffic area.
- G: Driving on uphill, downhill, or mountain roads repeatedly.
- H: Using for towing or camping and driving with loading on the roof.
- I: Driving for patrol car, taxi, other commercial use of vehicle towing.
- J: Frequently driving under high speed or rapid acceleration/deceleration.
- K: Frequently driving in stop-and-go conditions.
- L: Engine oil usage which is not recommended (Mineral type, Semi-synthetic, Lower grade spec, etc.)

Normal maintenance schedule – except Europe

The following maintenance services must be performed to ensure good emission control and performance. Keep receipts for all vehicle emission services to protect your warranty. Where both mileage and time are shown, the frequency of service is determined by whichever occurs first.

NO.	ITEM	REMARK
*1	Engine oil and engine oil filter	<ul style="list-style-type: none"> As it is normal for engine oil to be consumed during driving, the engine oil level should be checked on regular basis. The engine oil change interval for normal operating conditions is based on the use of the recommended engine specification. If the recommended engine oil specification is not used, then replace the engine oil according to the maintenance schedule under severe operating conditions.
*2	Coolant (Engine)	When adding coolant, use only deionized water or soft water for your vehicle and never mix hard water in the coolant filled at the factory. An improper coolant mixture can result in serious malfunction or engine damage.
*3	Coolant (HEV Inverter)	When adding coolant, use only deionized water or soft water for your vehicle and never mix hard water in the coolant filled at the factory. An improper coolant mixture can result in serious malfunction or engine damage.
*4	Coolant (PHEV Inverter)	Recommend that the coolant be replaced by an authorised Kia dealer/service partner.
*5	HSG (Hybrid Starter & Generator) belt	Inspect HSG belt for evidence of cuts, cracks, excessive wear or oil saturation and replace if necessary.
*6	Spark plug	For your convenience, it can be replaced prior to it's interval when you do maintenance of other items.
*7	Differential oil (Rear) (AWD)	Differential oil should be changed anytime it has been submerged in water.
*8	Transfer case oil (AWD)	Transfer case oil should be changed anytime it has been submerged in water.
*9	Fuel additives	<p>Kia recommends that you use unleaded petrol which has an octane rating of RON (Research Octane Number) 95 / AKI (Anti Knock Index) 91 or higher (for Europe) or Octane Rating of RON (Research Octane Number) 91 / AKI (Anti-Knock Index) 87 or higher (except Europe).</p> <p>For customers who do not use good quality petrols including fuel additives regularly, and have problems starting or the engine does not run smoothly, one bottle of additives should be added to the fuel tank when the engine oil is replaced. Additives are available from a professional workshop along with information on how to use them. Kia recommends to visit an authorised Kia dealer/service partner. Do not mix other additives.</p>

I: Inspect and if necessary, adjust, correct, clean or replace.

R: Replace or change.

Number of months or driving distance, whichever comes first									
Months		12	24	36	48	60	72	84	96
Miles × 1,000		10	20	30	40	50	60	70	80
Km × 1,000		15	30	45	60	75	90	105	120
Engine oil and engine oil filter* ¹		Replace every 10,000 km (6,500 miles) or 12 months							
Coolant (Engine)* ²		At first, Replace 210,000 km (140,000 miles) or 120 months After that, Replace every 30,000 km (20,000 miles) or 24 months							
Coolant (Inverter)	HEV* ³	At first, Replace 210,000 km (140,000 miles) or 120 months After that, Replace every 30,000 km (20,000 miles) or 24 months							
	PHEV* ⁴	Replace every 60,000 km (40,000 miles) or 36 months							
HSG (Hybrid Starter & Generator) belt* ⁵		Inspect every 10,000 km (6,500 miles) or 12 months Replace every 100,000 km (65,000 miles) or 48 months							
Spark plugs* ⁶	Unleaded	Replace every 70,000 km (45,500 miles)							
Automatic transmission (AT) fluid		No check, No service required							
Drive shaft and boots		-	I	-	I	-	I	-	I
Propeller shaft (AWD) (if equipped)		-	I	-	I	-	I	-	I
Rear differential oil (AWD)* ⁷ (if equipped)		-	-	-	I	-	-	-	I
Transfer case oil (AWD)* ⁸ (if equipped)		-	-	-	I	-	-	-	I
Fuel additives* ⁹		Add every 10,000 km (6,500 miles) or 12 months							
Fuel filter (Petrol)	For China, Brazil	-	I	-	R	-	I	-	R
Fuel lines, hoses and connections		-	-	-	I	-	-	-	I
Fuel tank air filter		-	I	-	R	-	I	-	R
Vapour hose and fuel filler cap (Petrol)		-	-	-	I	-	-	-	I
Air cleaner filter	Except China, India, Middle East	I	I	R	I	I	R	I	I
	For China, India, Middle East	R	R	R	R	R	R	R	R
Intercooler, in/out hose, air intake hose		Inspect every 10,000 km (6,500 miles) or 12 months							
Exhaust system		-	I	-	I	-	I	-	I
Cooling system		-	-	-	I	-	I	-	I
Air conditioner compressor/refrigerant		I	I	I	I	I	I	I	I
Climate control air filter		R	R	R	R	R	R	R	R
Brake discs and pads		-	I	-	I	-	I	-	I
Brake lines, hoses and connections		-	I	-	I	-	I	-	I

Number of months or driving distance, whichever comes first								
Months	12	24	36	48	60	72	84	96
Miles × 1,000	10	20	30	40	50	60	70	80
Km × 1,000	15	30	45	60	75	90	105	120
Brake fluid	I	I	R	I	I	R	I	I
Steering gear rack, linkage and boots	I	I	I	I	I	I	I	I
Suspension ball joints	I	I	I	I	I	I	I	I
Tyre (pressure & tread wear)	I	I	I	I	I	I	I	I
Battery (12V) condition	I	I	I	I	I	I	I	I

Maintenance under severe usage conditions- except Europe

I: Inspect and if necessary, adjust, correct, clean or replace.

R: Replace or change.

Maintenance item		Maintenance operation	Maintenance intervals	Driving condition
Engine oil and engine oil filter		R	Every 5,000 km (3,000 miles) or 6 months	A, B, C, D, E, F, G, H, I, J, K, L
HSG (Hybrid Starter & Generator) belt		R	Every 50,000 km (32,500 miles) or 24 months	B, C, D, E, I, K
		I	Every 10,000 km (6,500 miles) or 12 months	
Spark plugs	Unleaded	R	Replace more frequently depending on the condition	A, B, F, G, H, I, K
Automatic transmission (AT) fluid		R	Every 90,000 km (60,000 miles)	A, C, F, G, H, I, J, K
Drive shaft and boots		I	Inspect more frequently depending on the condition	C, D, E, F, G, H, I, J
Propeller shaft (AWD) (if equipped)		I	Inspect more frequently depending on the condition	C, D, E, F, G, H, I, J
Rear differential oil (AWD) (if equipped)		R	Every 120,000 km (80,000 miles)	C, E, G, H, I, J
Transfer case oil (AWD) (if equipped)		R	Every 120,000 km (80,000 miles)	C, E, G, H, I, J
Air cleaner filter		R	Replace more frequently depending on the condition	C, E
Climate control air filter		R	Replace more frequently depending on the condition	C, E, G
Brake discs, pads and calipers		I	Inspect more frequently depending on the condition	C, D, E, G, H, I, J, K
Steering gear rack, linkage and boots		I	Inspect more frequently depending on the condition	C, D, E, F, G
Suspension ball joints		I	Inspect more frequently depending on the condition	C, D, E, G, H, I

Severe driving conditions

A: Repeatedly driving short distance of less than 8 km (5 miles) in normal temperature or less than 16 km (10 miles) in freezing temperature.

B: Extensive engine idling or low speed driving for long distances.

C: Driving on rough, dusty, muddy, unpaved, gravelled or saltspread roads.

D: Driving in areas using salt or other corrosive materials or in very cold weather

E: Driving in heavy dust condition.

F: Driving in heavy traffic area.

G: Driving on uphill, downhill, or mountain roads repeatedly.

H: Using for towing or camping and driving with loading on the roof.

I: Driving for patrol car, taxi, other commercial use of vehicle towing.

J: Frequently driving under high speed or rapid acceleration/deceleration.

K: Frequently driving in stop-and-go conditions.

L: Engine oil usage which is not recommended (Mineral type, Semi-synthetic, Lower grade spec, etc.)

Explanation of scheduled maintenance items

Engine oil and filter

The engine oil and filter should be changed at the intervals specified in the maintenance schedule. If the vehicle is being driven in severe conditions, more frequent oil and filter changes are required.

Hybrid Starter & Generator (HSG) belt

Inspect all hybrid starter & generator belts for evidence of cuts, cracks, excessive wear or oil saturation and replace if necessary. Hybrid starter & generator belts should be checked periodically for proper tension and adjusted as necessary.

CAUTION

When you are inspecting the belt, place the ignition switch in the LOCK/OFF or ACC position.

Fuel filter

Kia petrol vehicles is equipped a lifetime fuel filter that integrated with the fuel tank. Regular maintenance or replacement is not needed but depends on fuel quality. If there are some important safety matters like fuel flow restriction, surging, loss of power, hard starting problem etc,

fuel filter inspection or replace is needed.

Have the fuel filter inspected or replaced by a professional workshop. Kia recommends to visit an authorised Kia dealer/service partner.

Fuel lines, fuel hoses and connections

Check the fuel lines, fuel hoses and connections for leakage and damage. Have the fuel lines, fuel hoses and connections replaced by a professional workshop. Kia recommends to visit an authorised Kia dealer/service partner.

Vapour hose and fuel filler cap

The vapour hose and fuel filler cap should be inspected at those intervals specified in the maintenance schedule. Make sure that a new vapour hose or fuel filler cap is correctly replaced.

Vacuum crankcase ventilation hoses

Inspect the surface of hoses for evidence of heat and/or mechanical damage. Hard and brittle rubber, cracking, tears, cuts, abrasions, and excessive swelling indicate deterioration. Particular attention should be paid to examine those hose sur-

faces nearest to high heat sources, such as the exhaust manifold.

Inspect the hose routing to assure that the hoses do not come in contact with any heat source, sharp edges or moving component which might cause heat damage or mechanical wear. Inspect all hose connections, such as clamps and couplings, to make sure they are secure, and that no leaks are present. Hoses should be replaced immediately if there is any evidence of deterioration or damage.

Air cleaner filter

Have the air cleaner filter replaced by a professional workshop. Kia recommends to visit an authorised Kia dealer/service partner.

Spark plugs

Make sure to install new spark plugs of the correct heat range.

When assembling parts, be sure to wipe the inside and outside of the boot bottom of the ignition coil and the insulator of the spark plug with a soft cloth to prevent contamination of the spark plug insulator.

⚠ WARNING

Do not disconnect and inspect spark plugs when the engine is hot. You may burn yourself.

Cooling system

Check the cooling system components, such as the radiator, coolant reservoir, hoses and connections for leakage and damage. Replace any damaged parts.

Coolant/inverter coolant

The coolant should be changed at the intervals specified in the maintenance schedule.

Automatic transmission fluid

Automatic transmission fluid should not be checked under normal usage conditions. Have the automatic transmission fluid changed by a professional workshop according to the maintenance schedule. Kia recommends to visit an authorised Kia dealer/service partner.

*** NOTICE**

Automatic transmission fluid colour is basically red.

As the vehicle is driven, the automatic transmission fluid will begin to look darker. It is normal condition and you should not judge the need

to replace the fluid based upon the changed colour.

CAUTION

The use of a non-specified fluid could result in transmission malfunction and failure.

Use only specified automatic transmission fluid. (Refer to "Recommended lubricants and capacities" on page 9-9.)

Brake hoses and lines

Visually check for proper installation, chafing, cracks, deterioration and any leakage. Replace any deteriorated or damaged parts immediately.

Brake fluid

Check the brake fluid level in the brake fluid reservoir. The level should be between "MIN" and "MAX" marks on the side of the reservoir. Use only hydraulic brake fluid conforming to DOT 4 specification.

Brake discs, pads and calipers

Check the pads for excessive wear, discs for run out and wear, and calipers for fluid leakage.

For more information on checking the pads or lining wear limit, we rec-

ommend to refer to the Kia web site.

(www.kia-hotline.com)

Suspension mounting bolts

Check the suspension connections for looseness or damage. Retighten to the specified torque.

Steering gear box, linkage & boots/ lower arm ball joint

With the vehicle stopped and engine off, check for excessive free-play in the steering wheel.

Check the linkage for bends or damage. Check the dust boots and ball joints for deterioration, cracks, or damage. Replace any damaged parts.

Drive shafts and boots

Check the drive shafts, boots and clamps for cracks, deterioration, or damage. Replace any damaged parts and, if necessary, repack the grease.

Air conditioning refrigerant

Check the air conditioning lines and connections for leakage and damage.

Propeller shaft (if equipped)

Check the propeller shaft, boots, clamps, rubber coupling and centre bearing rubber for cracks, deterioration, or damage. Replace any damaged parts and if necessary, repack the grease.

Checking fluid levels

When checking engine oil, engine coolant, brake fluid, and washer fluid, always be sure to clean the area around any filler plug, drain plug, or dipstick before checking or draining any lubricant or fluid. This is especially important in dusty or sandy areas and when the vehicle is used on unpaved roads. Cleaning the plug and dipstick areas will prevent dirt and grit from entering the engine and other mechanisms that could be damaged.

Engine oil and filter

Checking the engine oil level

Engine oil is used for lubricating, cooling, and operating various hydraulic components in the engine. Engine oil consumption whilst driving is normal, and it is necessary to check and refill the engine oil regularly. Also, check and refill the oil level within the recommended maintenance schedule to prevent deterioration of oil performance.

Check the engine oil following the below procedure.

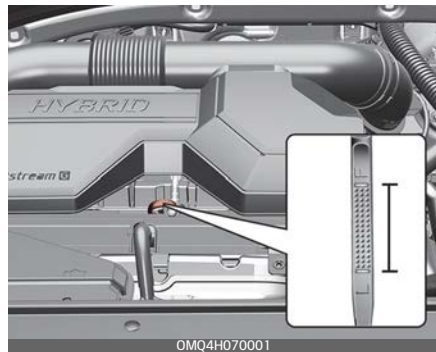

1. Be sure the vehicle is on level ground.
2. Start the engine and allow it to reach normal operating temperature.
3. Turn the engine off, remove the oil filler cap and pull the dipstick out. Wait for 15 minutes for the oil to return to the oil pan.
4. Wipe the dipstick clean and re-insert it fully.

- Pull the dipstick out again and check the level. Check if the oil level is between the F-L line, and if it is below the L line, add enough oil to bring the level to F line.

⚠ WARNING

Radiator hose

Be very careful not to touch the radiator hose when checking or adding the engine oil as it may be hot enough to burn you.

⚠ CAUTION

When you wipe the oil level gauge, you should wipe it with a clean cloth. When mixed with debris, it can cause engine damage.



Use a funnel to help prevent oil from being spilled on engine components.

Use only the specified engine oil. (Refer to "Recommended lubricants and capacities" on page 9-9.)

- Do not spill engine oil when adding or changing engine oil. Wipe off spilled oil immediately.
- The engine oil consumption may increase whilst you break in a new vehicle and it will be stabilized after driving 6,000 km (4,000 miles).
- The engine oil consumption can be affected by driving habits, climate conditions, traffic conditions, oil quality, etc. Therefore, it is recommended that you inspect the engine oil level regularly and refill it if necessary.

Changing the engine oil and filter

Have the engine oil and filter replaced by a professional workshop. Kia recommends to visit an authorised Kia dealer/service partner.

- If the maintenance schedule to replace engine oil is exceeded, the engine oil performance may deteriorate, and the engine condition may be affected. Therefore, replace the engine oil according to the maintenance schedule.

- To keep the engine in optimal condition, use the recommended engine oil and filter. If the recommended engine oil and filter are not used replace it according to the maintenance schedule under severe usage conditions.
- The purpose of the maintenance schedule for engine oil replacement is to prevent oil deterioration and it is irrelevant to oil consumption. Check and refill engine oil regularly.

WARNING

Used engine oil may cause irritation or cancer of the skin if left in contact with the skin for prolonged periods of time. Used engine oil contains chemicals that have caused cancer in laboratory animals. Always protect your skin by washing your hands thoroughly with soap and warm water as soon as possible after handling used oil. Do not leave used engine oil within the reach of children.

* NOTICE

When the oil pressure is low due to insufficient engine oil, the Engine Oil Pressure () warning light will illuminate.

In addition, the enhanced engine protection system, which limits the engine's power is activated and the Malfunction Indicator Lamp () will illuminate when the vehicle is driven in this state continuously.

When oil pressure is restored, the Engine Oil Pressure warning light will turn off and the engine power will no longer be limited.

CAUTION

The engine oil is very hot immediately after the vehicle has been driven and can cause burns during replacement. Replace the engine oil after the engine oil has cooled down.

Coolant

The high-pressure cooling system has a reservoir filled with year round antifreeze coolant. The reservoir is filled at the factory.

Check the antifreeze protection and coolant level at least once a year, at the beginning of the winter season, and before travelling to a colder climate.

Checking the engine coolant level

When adding coolant, use only deionised water, distilled water or soft water for your vehicle and never mix hard water in the coolant filled at the factory.

- An incorrect coolant mixture can result in severe malfunction or engine/hybrid system damage.
- The engine in your vehicle has aluminium engine parts and must be protected by an phosphate-based ethylene glycol coolant to prevent corrosion and freezing.
- Do not use alcohol or methanol coolant or mix them with the specified coolant.
- Do not use a solution that contains more than 60% antifreeze or less than 35% antifreeze, which would reduce the effectiveness of the solution.

- Check the condition and connections of all cooling system hoses and heater hoses. Replace any swollen or deteriorated hoses. The coolant level should be filled between MAX and MIN marks on the side of the coolant reservoir when the engine is cool. If the coolant level is low, add enough specified coolant to provide protection against freezing and corrosion. Bring the level to MAX, but do not overfill. If frequent additions are required, have the system inspected by a professional workshop. Kia recommends to visit an authorised Kia dealer/service partner.

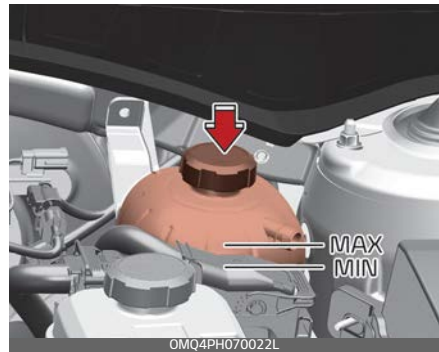

⚠ WARNING

Make sure the engine coolant reservoir cap is properly closed after refill or coolant.

Otherwise the engine could be overheated whilst driving.

1. Check if the engine coolant reservoir cap label is straight In front.



2. Make sure that the tiny protrusions inside the engine coolant reservoir cap are securely inter-locked.

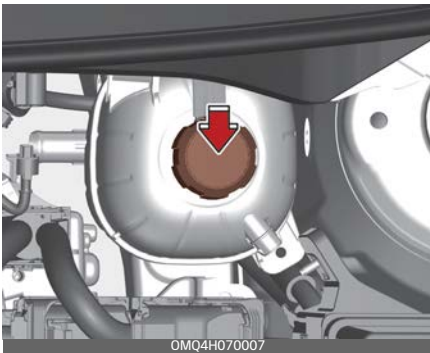

might lead to cooling system damage and could result in serious personal injury from escaping hot coolant or steam.

⚠ WARNING

Turn the vehicle off and wait until the engine cools down. Use extreme care when removing the engine coolant cap. Wrap a thick towel around it, and turn it slowly to the first stop. Step back whilst the pressure is released from the cooling system. When you are sure all the pressure has been released, press down on the cap, using a thick towel, and continue turning to remove it.

*** NOTICE**

The engine coolant level is influenced by the hybrid system temperature. Before checking or refilling the engine coolant, turn the hybrid vehicle off.

⚠ WARNING

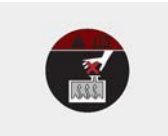

Removing engine coolant reservoir cap

Never attempt to remove the engine coolant reservoir cap whilst the engine is operating or hot. Doing so

*** NOTICE**

For mixture percentage, refer to the following table.

Ambient Temperature	Mixture Percentage (volume)	
	Antifreeze	Water
-15 °C (-5 °F)	35	65
-25 °C (-13 °F)	40	60

Ambient Temperature	Mixture Percentage (volume)	
	Antifreeze	Water
-35 °C (-31 °F)	50	50
-45 °C (-49 °F)	60	40

* NOTICE

To prevent damage to engine parts, put a thick towel around the engine coolant cap and/or inverter coolant cap before refilling the coolant to prevent the coolant from overflowing into engine parts, such as the alternator.

Changing the coolant

We recommend that the coolant be replaced by an authorised Kia dealer/service partner according to the Maintenance Schedule at the beginning of this chapter.

⚠ WARNING



Cooling fan

Use caution when working near the blade of the cooling fan. The electric motor (cooling fan) is controlled by coolant temperature, refrigerant pressure and vehicle speed. It may sometimes operate even when the vehicle is not running.

Checking the inverter coolant level (HEV)

If frequent additions are required, we recommend that the system be inspected by a professional workshop. Kia recommends to visit an authorised Kia dealer/service partner.

The inverter coolant level should be in between MAX and MIN when the engine is cooled down.

⚠ WARNING

Adding other cooling substances or water might lead to inverter cooling system degradation or even failure.

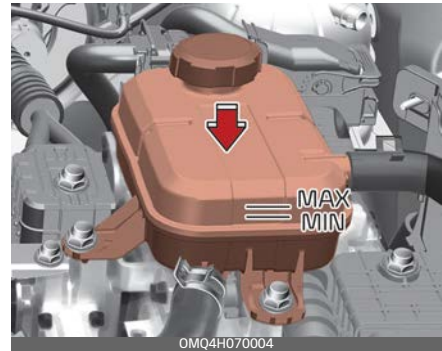

- Turn the vehicle off and wait until it cools down.
- Use extreme care when removing the inverter coolant reservoir cap. Wrap a thick towel around it, and turn it slowly to the first stop.

- Step back whilst the pressure is released from the cooling system.
- When you are sure all the pressure has been released, press down on the cap, using a thick towel, and continue turning to remove it.
- Check the condition and connections of all cooling system hoses and heater hoses.
- Replace any swollen or deteriorated hoses.
- Check the coolant level. The coolant level should be filled between MAX and MIN marks on the side of the coolant reservoir when the engine room is cool.
- If the coolant level is low, add enough specified coolant to provide protection against freezing and corrosion. Bring the level to MAX, but do not overfill.

⚠ WARNING

Make sure the inverter coolant reservoir cap is properly closed after refill or coolant.

Otherwise the inverter could be overheated whilst driving.

1. Check if the inverter coolant reservoir cap label is straight in front.



2. Make sure that the tiny protrusions inside the inverter coolant reservoir cap are securely interlocked.

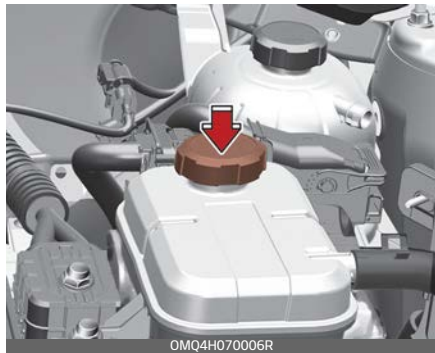

⚠ WARNING

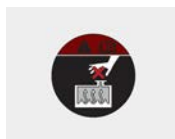

Removing inverter coolant reservoir cap

Never remove the inverter coolant reservoir cap whilst the engine and radiator are hot. Hot coolant and

steam may blow out under pressure, causing serious injury.

Changing the coolant

We recommend that the coolant be replaced by an authorised Kia dealer/service partner according to the Maintenance Schedule at the beginning of this chapter.

⚠ WARNING



Cooling fan

Use caution when working near the blade of the cooling fan. The electric

motor (cooling fan) is controlled by coolant temperature, refrigerant pressure and vehicle speed. It may sometimes operate even when the vehicle is not running.

Checking the inverter coolant level (PHEV)

If frequent additions are required, we recommend that the system be inspected by a professional workshop. Kia recommends to visit an authorised Kia dealer/service partner.

The inverter coolant level should be in between MAX and MIN when the engine is cooled down.

⚠ WARNING

Adding other cooling substances or water might lead to inverter cooling system degradation or even failure.

⚠ WARNING



Removing inverter coolant reservoir cap

Never remove the inverter coolant reservoir cap whilst the engine and radiator are hot. Hot coolant and steam may blow out under pressure, causing serious injury.

Changing the coolant

We recommend that the coolant be replaced by an authorised Kia dealer/service partner according to the Maintenance Schedule at the beginning of this chapter.

⚠ WARNING

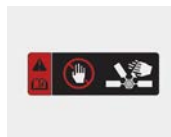

Cooling fan

Use caution when working near the blade of the cooling fan. The electric motor (cooling fan) is controlled by coolant temperature, refrigerant pressure and vehicle speed. It may

sometimes operate even when the vehicle is not running.

Hybrid starter & generator (HSG) belt

Checking the Hybrid Starter & Generator (HSG) belt

We recommend that you have the Hybrid Starter & Generator (HSG) belt inspected or replaced according to the Maintenance Schedule in this chapter by an authorised Kia dealer/service partner.

CAUTION

When the HSG belt is worn out or damaged, replace the belt. Otherwise, it may cause engine overheating or battery discharge.

WARNING

- Turn the vehicle off whilst you inspect the engine or Hybrid Starter & Generator (HSG) belt. Otherwise it may result in serious injury.
 - Keep hands, clothing etc. away from the Hybrid Starter & Generator (HSG) belt
-

Brake fluid

Checking the brake fluid level

Check the fluid level in the reservoir periodically. The fluid level should be between MAX and MIN marks on the side of the reservoir.

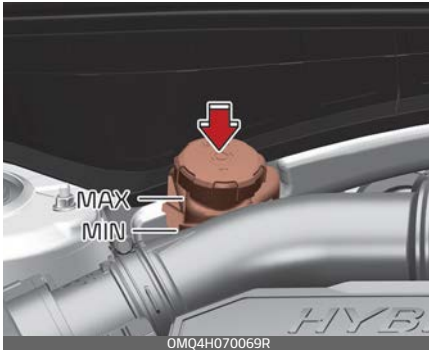

1. Before removing the reservoir cap and adding brake fluid, clean the area around the reservoir cap thoroughly to prevent brake fluid contamination.
2. Periodically check that the fluid level in the brake fluid reservoir is between MIN and MAX. The level will fall with accumulated mileage. This is a normal condition associated with the wear of the brake linings.

If the fluid level is excessively low, have the system checked by a professional workshop. Kia recommends to visit an authorised Kia dealer/service partner.

Use only the specified brake fluid. (Refer to "Recommended lubricants and capacities" on page 9-9.)

Never mix different types of fluid.

⚠ WARNING

Loss of brake fluid

In the event the brake system requires frequent additions of fluid, have the system inspected by a professional workshop. Kia recommends to visit an authorised Kia dealer/service partner.

⚠ WARNING

Brake fluid

When changing and adding brake fluid, handle it carefully. Do not let it come in contact with your eyes. If brake fluid should come in contact with your eyes, immediately flush them with a large quantity of fresh tap water. Have your eyes examined by a doctor as soon as possible.

⚠ CAUTION

Do not allow brake fluid to contact the vehicle's body paint, as paint damage will result. Brake fluid, which has been exposed to open air for an extended time should never be used as its quality cannot be guaranteed. It should be properly disposed. Don't put in the wrong

kind of fluid. A few drops of mineral-based oil, such as engine oil, in your brake system can damage brake system parts.

Washer fluid

Checking the washer fluid level

The reservoir is translucent so that you can check the level with a quick visual inspection.

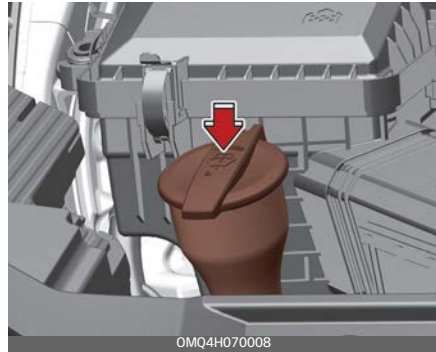

- Check the fluid level in the washer fluid reservoir and add fluid if necessary. Plain water may be used if washer fluid is not available. However, use washer solvent with antifreeze characteristics in cold climates to prevent freezing.

⚠ WARNING

Washer fluid

- Do not use radiator coolant or antifreeze in the washer fluid reservoir.
- Radiator coolant can severely obscure visibility when sprayed on the windscreen and may cause loss of vehicle control or damage to paint and body trim.

- Windscreen Washer fluid agents contain some amounts of alcohol and can be flammable under certain circumstances. Do not allow sparks or flame to contact the washer fluid or the washer fluid reservoir. Damage to the vehicle or occupants could occur.
- Windscreen washer fluid is poisonous to humans and animals. Do not drink and avoid contacting windscreen washer fluid. Serious injury or death could occur.

Air cleaner filter

A genuine Kia air cleaner filter is recommended when the filter is replaced.

Replacing air cleaner filter

Air cleaner filter must be replaced when necessary, and should not be washed.

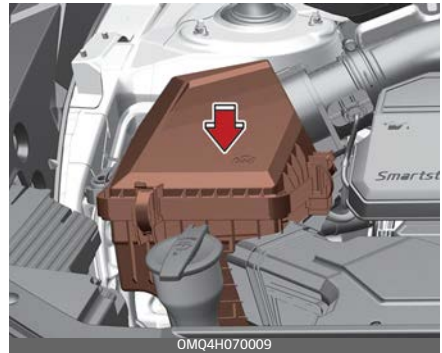

You can clean the filter when inspecting the air cleaner compartment. Clean the filter by using compressed air.

1. Loosen the air cleaner cover attaching clips and open the cover.

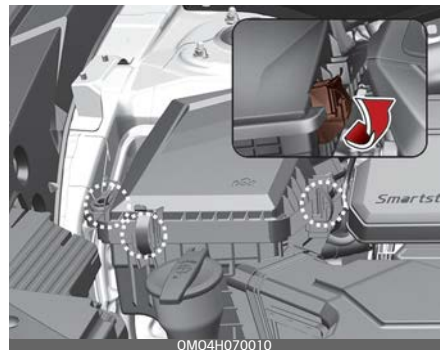

2. Wipe the inside of the air cleaner.

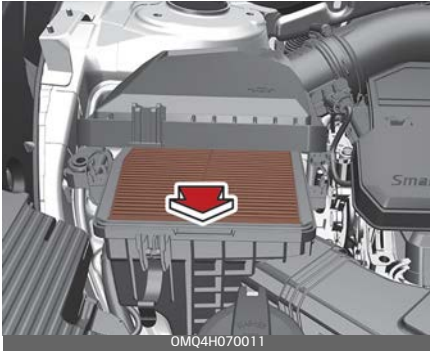

3. Replace the air cleaner filter.

4. Lock the cover with the cover attaching clips.

Replace the filter according to the Maintenance Schedule.

* NOTICE

If the vehicle is operated in extremely dusty or sandy areas, replace the element more often than the usual recommended intervals. (Refer to "Severe driving conditions" on page 8-24.)

⚠ CAUTION

Air filter maintenance

- Do not drive with the air cleaner removed; this will result in excessive engine wear.
- When removing the air cleaner filter, be careful that dust or dirt does not enter the air intake, or damage may result.

- Use a Kia genuine part. Use of a non-genuine part could damage the air flow sensor. We recommend that you use parts for replacement from an authorised Kia dealer/service partner.

Climate control air filter

Filter inspection

The climate control air filter should be replaced according to the maintenance schedule. If the vehicle is operated in severely air-polluted cities or on dusty rough roads for a long period, it should be inspected more frequently and replaced earlier. When you replace the climate control air filter, replace it performing the following procedure, and be careful to avoid damaging other components.

1. Open the glove box and remove the stoppers(1) on both sides.



2. With the glove box open, pull the support strap.



3. Remove the climate control air filter cover by pulling out both sides of the cover.

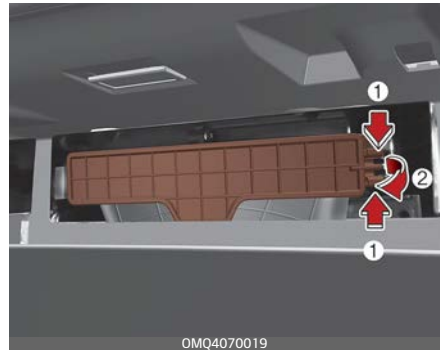

4. Replace the climate control air filter.



5. Reassemble in the reverse order of disassembly.

* NOTICE

When replacing the climate control air filter install it properly. Otherwise, the system may produce noise and the effectiveness of the filter may be reduced.

Wiper blades

Blade inspection



* NOTICE

Commercial hot waxes applied by automatic car washes have been known to make the windshield difficult to clean.

Contamination of either the windshield or the wiper blades with foreign matter can reduce the effectiveness of the windshield wipers. Common sources of contamination are insects, tree sap, and hot wax treatments used by some commercial car washes. If the blades are not wiping properly, clean both the window and the blades with a good cleaner or mild detergent, and rinse thoroughly with clean water.

⚠ CAUTION

To prevent damage to the wiper blades, do not use petrol, kerosene, paint thinner, or other solvents on or near them.

Blade replacement

When the wipers no longer clean adequately, the blades may be worn or cracked, and require replacement.

⚠ CAUTION

To prevent damage to the wiper arms or other components, do not attempt to move the wipers manually.

⚠ CAUTION

The use of a non-specified wiper blade could result in wiper malfunction and failure.

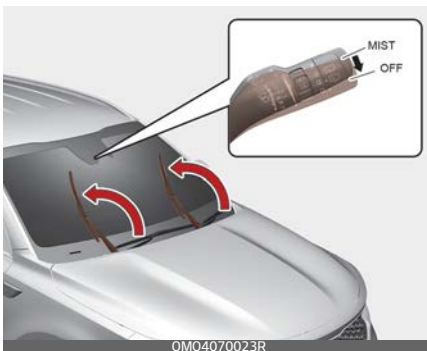
Front windscreen wiper blade

For your convenience, move the windscreen wiper blades to the service position as follows;

After turning off the engine, move the wiper switch to the single wiping (MIST) position within 20 seconds and hold the switch more than 2 seconds until the wiper blade is in the fully up position.

⚠ CAUTION

Do not allow the wiper arm to fall against the windscreen, since it may chip or crack the windscreen.

Conventional type (if equipped)

1. Raise the wiper arm.
2. Lift up the wiper blade clip. Then pull down the blade assembly and remove it.

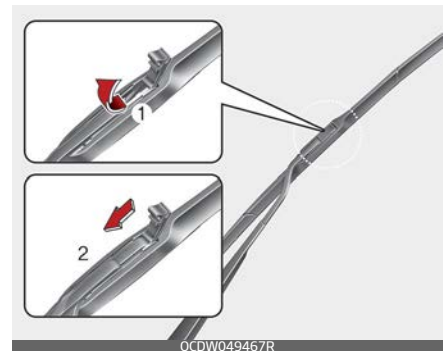

3. Install the new blade assembly.



4. Return the wiper arm on the windscreen.
5. Turn the ignition switch or ENGINE START/STOP button to the ON position and wiper arms will return to the normal operating position.

Aero type (if equipped)

1. Raise the wiper arm.
2. Push the button of wiper blade clip. Lift up the wiper blade. Then pull up the blade assembly and remove it.



3. Install the new blade assembly.



4. Return the wiper arm on the windscreen.
5. Turn the ignition switch or ENGINE START/STOP button to the ON position and wiper arms will return to the normal operating position.

Replacing rear wiper blade



Move the rear wiper to the bottom middle part, and lift up the wiper arm. Pull the wiper blade to remove it.

1. Within 20 seconds after the vehicle ignition is OFF, pull down the wiper lever to MIST position for over 2 seconds until the wiper moves down to the bottom middle part.
2. Raise the wiper arm and pull out the wiper blade assembly.



3. Lift up the wiper blade, and pull the blade to remove it.

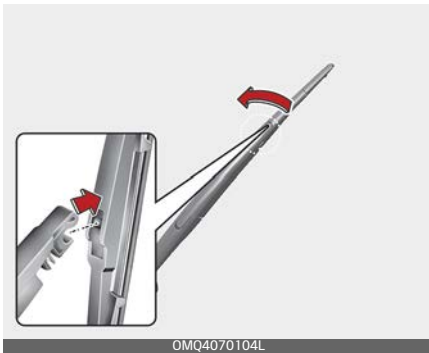

4. Install the new blade assembly by inserting the centre part into the slot in the wiper arm until it clicks into place.



- If the replacement is complete, put down the wiper arm to place it on the rear windscreen, and turn the vehicle ignition to ON and operate the wipers to check the blade is installed correctly.
5. Make sure the blade assembly is installed firmly by trying to pull it slightly.

To prevent damage to the wiper arms or other components, have the wiper blade replaced by a professional workshop. Kia recommends to visit an authorised Kia dealer/service partner.

⚠ CAUTION

If the wiper arm receives too much force whilst pulling the blade, the centre part may be damaged.

⚠ CAUTION

- The wiper could not operate for approx. 10 seconds when the wiper is operated without washer fluid or the blades are frozen. This is not a malfunction, it is a wiper protection system activated by motor overload circuit within the wiper motor.
- The front windscreen should be cleaned with water hose and wiped with clean towel with wiper blades raised up. Also, the wiper blades should be wiped clean when the grease or wax is applied to the blades.

Battery

For best battery service

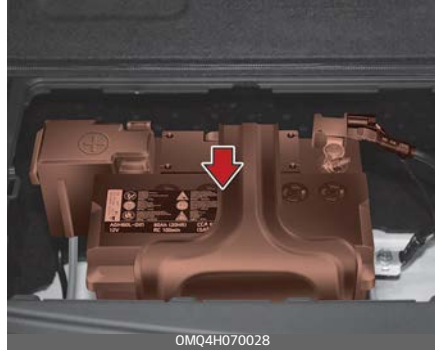

- Keep the battery securely mounted.
- Keep the battery top clean and dry.
- Keep the terminals and connections clean, tight, and coated with petroleum jelly or terminal grease.
- Rinse any spilled electrolyte from the battery immediately with a solution of water and baking soda.
- If the vehicle is not going to be used for an extended time, disconnect the battery cables.

* NOTICE

Your vehicle is equipped with maintenance free battery. If your vehicle is equipped with the battery marked with LOWER and UPPER on the side, you can check the electrolyte level. The electrolyte level should be between LOWER and UPPER. If the electrolyte level is low, it needs to

add distilled (demineralised) water (Never add sulfuric acid or other electrolyte). When refill, be careful not to splash the battery and adjacent components. And do not overfill the battery cells. It can cause corrosion on other parts. Make sure that the cell caps are tightened.

Contact a professional workshop. Kia recommends to visit an authorised Kia dealer/service partner.

WARNING

Battery dangers



Always read the following instructions carefully when handling a battery.



Keep lighted cigarettes and all other flames or sparks away from the battery.



Hydrogen, a highly combustible gas, is always present in battery cells and may explode if ignited.



Keep batteries out of the reach of children because batteries contain highly corrosive SULFURIC ACID.

Do not allow battery acid to contact your skin, eyes, clothing or paint finish.



If any electrolyte gets into your eyes, flush your eyes with clean water for at

least 15 minutes and get immediate medical attention.

If electrolyte gets on your skin, thoroughly wash the contacted area. If you feel pain or burning sensation, get medical attention immediately.



Wear eye protection when charging or working near a battery. Always provide ventilation when working

in an enclosed space.



An inappropriately disposed battery can be harmful to the environment and human health.

Dispose the battery according to your local law(s) or regulation.

- When lifting a plastic-cased battery, excessive pressure on the case may cause battery acid to leak, resulting in personal injury. Lift with a battery carrier or with your hands on opposite corners.
- Never attempt to recharge the battery when the battery cables are connected.
- The electrical ignition system works with high voltage. Never touch these components with the engine running or the ignition switch is on.

Failure to follow the above warnings can result in serious bodily injury or death.

⚠ CAUTION

- If you connect unauthorised electronic devices to the battery, the battery may be discharged. Never use unauthorised devices.

Battery capacity label

Example



* The actual battery label in the vehicle may differ from the illustration.

1. AGM60L-DIN: The Kia model name of battery
2. 60Ah (20HR): The nominal capacity (in Ampere hours)
3. CCA 640A: The cold-test current in amperes by SAE
4. 12V: The nominal voltage
5. RC 100min: The nominal reserve capacity (in min.)

Battery recharging

Your vehicle has a maintenance-free, calcium-based battery.

- If the battery becomes discharged in a short time (because, for example, the headlights or interior lights were left on whilst the vehicle was not in use), recharge it

by slow charging (trickle) for 10 hours.

- If the battery gradually discharges because of high electric load whilst the vehicle is being used, recharge it at 20 ~ 30A for 2 hours.

⚠ WARNING

Recharging battery

When recharging the battery, observe the following precautions:

- The battery must be removed from the vehicle and placed in an area with good ventilation.
- Do not allow cigarettes, sparks, or flame near the battery.
- Watch the battery during charging, and stop or reduce the charging rate if the battery cells begin gassing (boiling) violently or if the temperature of the electrolyte of any cell exceeds 49°C (120°F).
- Wear eye protection when checking the battery during charging.
- Disconnect the battery charger in the following order.
 1. Turn off the battery charger main switch.
 2. Unhook the negative clamp from the negative battery terminal.
 3. Unhook the positive clamp from the positive battery terminal.

⚠ WARNING

- Before performing maintenance or recharging the battery, turn off all accessories and stop the engine.
 - The negative battery cable must be removed first and installed last when the battery is disconnected.
-

⚠ CAUTION**AGM battery**

- Absorbent Glass Matt (AGM) batteries are maintenance free and have the AGM battery serviced by a professional workshop. Kia recommends to visit an authorised Kia dealer/service partner. For charging your AGM battery, use only fully automatic battery chargers that are specially developed for AGM batteries.
 - When replacing the AGM battery, use parts for replacement from a professional workshop. Kia recommends to visit an authorised Kia dealer/service partner.
 - Do not open or remove the cap on top of the battery. This may cause leaks of internal electrolyte that could result in severe injury.
-

Reset items

Items should be reset after the battery has been discharged or the battery has been disconnected.

- Auto up/down window
- Sunroof
- Trip computer
- Climate control system
- Integrated Memory System
- Audio

Tyres and wheels

Tyre care

For proper maintenance, safety, and maximum fuel economy, you must always maintain recommended tyre inflation pressures and stay within the load limits and weight distribution recommended for your vehicle.

Recommended cold tyre inflation pressures

All tyre pressures (including the spare) should be checked when the tyres are cold. "Cold Tyres" means the vehicle has not been driven for at least three hours or driven less than 1.6 km (one mile).

Recommended pressures must be maintained for the best ride, top vehicle handling, and minimum tyre wear.

For recommended inflation pressure, refer to "Tyres and wheels" on page 9-7.



OMQ4080004R

All specifications (sizes and pressures) can be found on a label attached to the vehicle.

⚠ WARNING

Tyre underinflation

Severe underinflation (70 kPa (10 psi) or more) can lead to severe heat build-up, causing blowouts, tread separation and other tyre failures that can result in the loss of vehicle control leading to severe injury or death. This risk is much higher on hot days and when driving for long periods at high speeds.

⚠ CAUTION

- Underinflation also results in excessive wear, poor handling and reduced fuel economy. Wheel deformation also is possible. Keep your tyre pressures at the proper levels. If a tyre frequently needs refilling, have the system checked by a professional workshop. Kia recommends to visit an authorised Kia dealer/service partner.
- Overinflation produces a harsh ride, excessive wear at the centre of the tyre tread, and a greater possibility of damage from road hazards.

⚠ CAUTION

- Warm tyres normally exceed recommended cold tyre pressures by 28 to 41 kPa (4 to 6 psi). Do not release air from warm tyres to adjust the pressure or the tyres will be underinflated.
- Be sure to reinstall the tyre inflation valve caps. Without the valve cap, dirt or moisture could get into the valve core and cause air leakage. If a valve cap is missing, install a new one as soon as possible.

⚠ WARNING**Tyre Inflation**

Overinflation or underinflation can reduce tyre life, adversely affect vehicle handling, and lead to sudden tyre failure. This could result in loss of vehicle control and potential injury.

⚠ CAUTION**Tyre pressure**

Always observe the following:

- Check tyre pressure when the tyres are cold. (After vehicle has been parked for at least three hours or hasn't been driven more than 1.6 km (one mile) since startup.)
- Check the pressure of your spare tyre each time you check the pressure of other tyres.
- Never overload your vehicle. Be careful not to overload a vehicle luggage rack if your vehicle is equipped with one.
- Worn, old tyres can cause accidents. If your tread is badly worn, or if your tyres have been damaged, replace them.

Checking tyre inflation pressure

Check your tyres once a month or more.

Also, check the tyre pressure of the spare tyre.

How to check

Use a good quality gauge to check tyre pressure. You can not tell if your tyres are properly inflated simply by looking at them. Radial tyres may look properly inflated even when they're underinflated.

- Check the tyre's inflation pressure when the tyres are cold. - "Cold" means your vehicle has been sitting for at least three hours or driven no more than 1.6 km (1 mile).
- Remove the valve cap from the tyre valve stem. Press the tyre gauge firmly onto the valve to get a pressure measurement. If the cold tyre inflation pressure

matches the recommended pressure on the tyre and loading information label, no further adjustment is necessary. If the pressure is low, add air until you reach the recommended amount. If you overfill the tyre, release air by pushing on the metal stem in the centre of the tyre valve. Recheck the tyre pressure with the tyre gauge. Be sure to put the valve caps back on the valve stems. They help prevent leaks by keeping out dirt and moisture.

WARNING

- Inspect your tyres frequently for proper inflation as well as wear and damage. Always use a tyre pressure gauge.
- Tyres with too much or too little pressure wear unevenly causing poor handling, loss of vehicle control, and sudden tyre failure leading to accidents, injuries, and even death. The recommended cold tyre pressure for your vehicle can be found in this manual and on the tyre label located on the driver's side centre pillar.
- Worn tyres can cause accidents. Replace tyres that are worn, show uneven wear, or are damaged.
- Remember to check the pressure of your spare tyre. Kia recommends that you check the spare every time you check the pressure of the other tyres on your vehicle.

Tyre rotation

To equalise tread wear, it is recommended that the tyres be rotated every 10,000 km (6,500 miles) or sooner if irregular wear develops.

During rotation, check the tyres for correct balance.

When rotating tyres, check for uneven wear and damage. Abnormal wear is usually caused by incorrect tyre pressure, improper wheel alignment, out-of-balance wheels, severe braking or severe cornering. Look for bumps or bulges in the tread or side of tyre. Replace the tyre if you find either of these conditions. Replace the tyre if fabric or cord is visible. After rotation, be sure to bring the front and rear tyre pressures to specification and check lug nut tightness.

Refer to "Tyres and wheels" on page 9-7.

With a full-size spare tyre (if equipped)

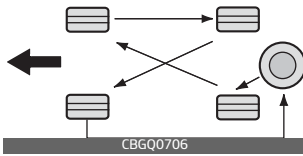

Without a spare tyre

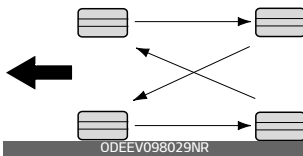

Directional tyres (if equipped)

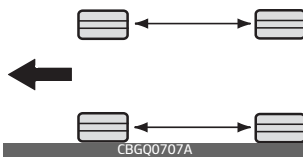

Disc brake pads should be inspected for wear whenever tyres are rotated.

* NOTICE

Rotate radial tyres that have an asymmetric tread pattern only from front to rear and not from right to left.

⚠ WARNING

- Do not use the compact spare tyre for tyre rotation.
- Do not mix bias ply and radial ply tyres under any circumstances. This may cause unusual handling characteristics that could result in death, severe injury, or property damage.

Wheel alignment and tyre balance

The wheels on your vehicle were aligned and balanced carefully at the factory to give you the longest tyre life and best overall performance.

In most cases, you will not need to have your wheels aligned again. However, if you notice unusual tyre wear or your vehicle pulling one way or the other, the alignment may need to be reset.

If you notice your vehicle vibrating when driving on a smooth road, your wheels may need to be rebalanced.

⚠ CAUTION

Improper wheel weights can damage your vehicle's aluminium wheels. Use only approved wheel weights.

Tyre replacement

If the tyre is worn evenly, a tread wear indicator will appear as a solid band across the tread.



[A] : Tread wear indicator

This shows there is less than 1.6 mm (1/16 in.) of tread left on the tyre. Replace the tyre when this happens.

Do not wait for the band to appear across the entire tread before replacing the tyre.

* NOTICE

We recommend that when replacing tyres, use the same originally supplied with the vehicles. If not, that affects driving performance.

⚠ CAUTION

When replacing the tyres, recheck and tighten the wheel nuts after driving about 50 km (31 miles) and recheck after driving about 1,000 km (620 miles). If the steering wheel shakes or the vehicle vibrates whilst driving, the tyre is out of balance. Align the tyre balance. If the problem is not solved, contact a professional workshop. Kia recommends to visit an authorised Kia dealer/service partner.

⚠ WARNING

Replacing tyres

To reduce the chance of serious or fatal injuries from an accident caused by tyre failure or loss of vehicle control:

- Replace tyres that are worn, show uneven wear, or are damaged. Worn tyres can cause loss of braking effectiveness, steering control, and traction.
- Do not drive your vehicle with too little or too much pressure in your tyres. This can lead to uneven wear and tyre failure.
- When replacing tyres, never mix radial and bias-ply tyres on the same car. You must replace all tyres (including the spare) if moving from radial to bias-ply tyres.
- It is best to replace all four tyres at the same time. If that is not

possible, or necessary, then replace the two front or two rear tyres as a pair.

Replacing just one tyre can seriously affect your vehicle's handling.

- Using tyres and wheels other than the recommended sizes could cause unusual handling characteristics and poor vehicle control, resulting in a serious accident.
- Wheels that do not meet Kia's specifications may fit poorly and result in damage to the vehicle or unusual handling and poor vehicle control.
- The ABS works by comparing the speed of the wheels. The tyre size affects wheel speed. When replacing tyres, all 4 tyres must use the same size, type, construction and tread pattern originally supplied with the vehicle. Using tyres of a different size can cause the ABS (Anti-lock Brake System) and ESC (Electronic Stability Control) to work irregularly.

Compact spare tyre replacement (if equipped)

A compact spare tyre has a shorter tread life than a regular size tyre. Replace it when you can see the tread wear indicator bars on the tyre. The replacement compact spare tyre should be the same size

and design tyre as the one provided with your new vehicle and should be mounted on the same compact spare tyre wheel. The compact spare tyre is not designed to be mounted on a regular size wheel, and the compact spare tyre wheel is not designed for mounting a regular size tyre.

Wheel replacement

When replacing the metal wheels for any reason, make sure the new wheels are equivalent to the original factory units in diameter, rim width and offset.

⚠ WARNING

A wheel that is not the correct size may adversely affect wheel and bearing life, braking and stopping abilities, handling characteristics, ground clearance, body-to-tyre clearance, snow chain clearance, speedometer and odometer calibration, headlight aim and bumper height.

Tyre traction

Tyre traction can be reduced if you drive on worn tyres, tyres that are improperly inflated or on slippery road surfaces. Tyres should be replaced when tread wear indicators appear. Slow down whenever there

is rain, snow or ice on the road to reduce the possibility of losing control of the vehicle.

Tyre maintenance

In addition to proper inflation, correct wheel alignment helps to decrease tyre wear. If you find a tyre is worn unevenly, have a professional workshop check the wheel alignment. Kia recommends to visit an authorised Kia dealer/service partner.

Make sure the newly installed tyres are balanced correctly to increase vehicle ride comfort and tyre life. In addition, always rebalance the tyre when the tyre is removed from the wheel.

Tyre sidewall labelling

This information identifies and describes the fundamental characteristics of the tyre and also provides the tyre identification number (TIN) for safety standard certification.

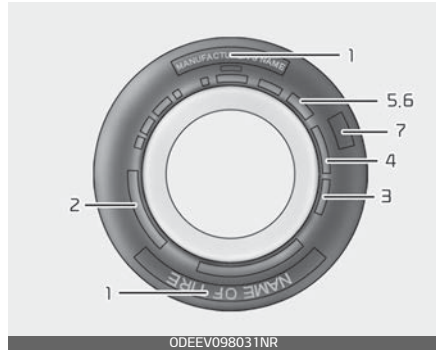

The TIN can be used to identify the tyre in case of a recall.

1. Manufacturer or brand name

Manufacturer or Brand name is shown.

2. Tyre size designation

A tyre's sidewall is marked with a tyre size designation. You will need this information when selecting replacement tyres for your vehicle. The following explains what the letters and numbers in the tyre size designation mean.

Example tyre size designation:

(These numbers are provided as an example only; your tyre size designator could vary depending on your vehicle.)

P235/55R19 108T

235 - Tyre width in millimetres.

55 - Aspect ratio. The tyre's section height as a percentage of its width.

R - Tyre construction code (Radial).

19 - Rim diameter in inches.

108 - Load Index, a numerical code associated with the maximum load the tyre can carry.

T - Speed Rating Symbol. See the speed rating chart in this section for additional information.

Wheel size designation

Wheels are also marked with important information that you need if you ever have to replace one. The following explains what the letters and numbers in the wheel size designation mean.

Example wheel size designation:

7.5JX19

7.5 - Rim width in inches.

J - Rim contour designation.

19 - Rim diameter in inches.

Tyre speed ratings

The chart below lists many of the different speed ratings currently being used for passenger car tyres. The speed rating is part of the tyre size designation on the sidewall of the tyre. This symbol corresponds to that tyre's designed maximum safe operating speed.

Speed Rating Symbol	Maximum Speed
S	180 km/h (112 mph)
T	190 km/h (118 mph)
H	210 km/h (130 mph)

Speed Rating Symbol	Maximum Speed
V	240 km/h (149 mph)
W	270 km/h (168 mph)
Y	300 km/h (186 mph)

3. Checking tyre life (TIN : Tyre Identification Number)

Any tyres that are over 6 years old, based on the manufacturing date, (including the spare tyre) should be replaced by new ones. You can find the manufacturing date on the tyre sidewall (possibly on the inside of the wheel), displaying the DOT Code. The DOT Code is a series of numbers on a tyre consisting of numbers and English letters. The manufacturing date is designated by the last four digits (characters) of the DOT code.

DOT: XXXX XXXX 0000

The front part of the DOT means a plant code number, tyre size and tread pattern and the last four numbers indicate week and year manufactured.

For example:

DOT XXXX XXXX 1622 represents that the tyre was produced in the 16th week of 2022.

WARNING

Tyre age

Tyres degrade over time, even when they are not being used. Regardless of the remaining tread, we recommend that tyres be replaced after approximately six (6) years of normal service. Heat caused by hot climates or frequent high loading conditions can accelerate the aging process. Failure to follow this warning can result in sudden tyre failure, which could lead to a loss of control and an accident involving serious injury or death.

4. Tyre ply composition and material

The number of layers or plies of rubber-coated fabric in the tyre. Tyre manufacturers also must indicate the materials in the tyre, which include steel, nylon, polyester, and others. The letter "R" means radial ply construction; the letter "D" means diagonal or bias ply construction; and the letter "B" means belted-bias ply construction.

5. Maximum permissible inflation pressure

This number is the greatest amount of air pressure that should be put in the tyre. Do not exceed the maximum permissible inflation pressure.

Refer to "Tyre specification and pressure label" on page 9-13.

6. Maximum load rating

This number indicates the maximum load in kilograms and pounds that can be carried by the tyre. When replacing the tyres on the vehicle, always use a tyre that has the same load rating as the factory installed tyre.

7. Uniform tyre quality grading

Quality grades can be found where applicable on the tyre sidewall between tread shoulder and maximum section width.

For example:

TREADWEAR 200

TRACTION AA

TEMPERATURE A

Tread wear

The tread wear grade is a comparative rating based on the wear rate of the tyre when tested under controlled conditions on a specified government test course. For example, a tyre graded 150 would wear one-and-a-half times (1½) as well on the government course as a tyre graded 100.

The relative performance of tyres depends upon the actual conditions of their use, however, and may depart significantly from the norm

due to variations in driving habits, service practices and differences in road characteristics and climate. These grades are molded on the side-walls of passenger vehicle tyres. The tyres available as standard or optional equipment on your vehicle may vary with respect to grade.

Traction – AA, A, B & C

The traction grades, from highest to lowest, are AA, A, B and C. Those grades represent the tyre's ability to stop on wet pavement as measured under controlled conditions on specified government test surfaces of asphalt and concrete. A tyre marked C may have poor traction performance.

Temperature –A, B & C

The temperature grades are A (the highest), B, and C, representing the tyre's resistance to the generation of heat and its ability to dissipate heat when tested under controlled conditions on a specified indoor laboratory test wheel.

Sustained high temperature can cause the material of the tyre to degenerate and reduce tyre life, and excessive temperature can lead to sudden tyre failure. Grades B and A represent higher levels of performance on the laboratory test wheel than the minimum required by law.

WARNING

The traction grade assigned to this tyre is based on straight ahead braking traction tests, and does not include acceleration, cornering, hydroplaning, or peak traction characteristics.

WARNING

Tyre temperature

The temperature grade for this tyre is established for a tyre that is properly inflated and not overloaded. Excessive speed, underinflation, or excessive loading, either separately or in combination, can cause heat build-up in tyre and sudden tyre failure. This can cause loss of vehicle control and serious injury or death.

Low aspect ratio tyre (if equipped)

Low aspect ratio tyres, whose aspect ratio is lower than 50, are provided for sporty looks.

Because the low aspect ratio tyres are optimised for handling and braking, it may be more uncomfortable to ride in and there is more noise compare with normal tyres.

⚠ CAUTION

Because the sidewall of the low aspect ratio tyre is shorter than the normal, the wheel and tyre of the low aspect ratio tyre is easier to be damaged. So, follow the instructions below.

- When driving on a rough road or off road, drive cautiously because tyres and wheels may be damaged. And after driving, inspect tyres and wheels.
 - When passing over a pothole, speed bump, manhole, or kerb stone, drive slowly so that the tyres and wheels are not damaged.
 - If the tyre is impacted, inspect the tyre condition or contact a professional workshop. Kia recommends to visit an authorised Kia dealer/service partner.
 - To prevent damage to the tyre, inspect the tyre condition and pressure every 3,000 km.
-

⚠ CAUTION

- It is not easy to recognise the tyre damage with your own eyes. But if there is the slightest hint of tyre damage, even though you cannot see the tyre damage with your own eyes, have the tyre checked or replaced because the tyre damage may cause air leakage from the tyre.
 - If the tyre is damaged by driving on a rough road, off road, pothole, manhole, or kerb stone, it will not be covered by the warranty.
 - You can find out the tyre information on the tyre sidewall.
-

Fuses

Blade type



Cartridge type



Multi fuse

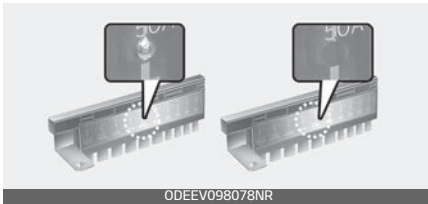

High voltage fuse

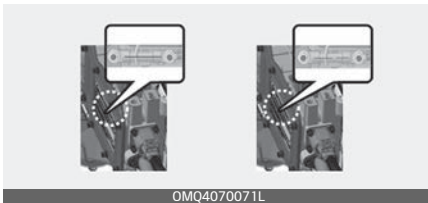

* Left side: Normal, Right side:
Blown

* The actual fuse/relay panel label
may differ from equipped items.

A vehicle's electrical system is protected from electrical overload damage by fuses.

This vehicle has 2 (or 3) fuse panels, one located in the driver's side panel bolster, the others in the engine compartment.

If any of your vehicle's lights, accessories, or controls do not work, check the appropriate circuit fuse. If a fuse has blown, the element inside the fuse will melt.

If the electrical system does not work, first check the driver's side fuse panel.

Before replacing a blown fuse, disconnect the negative battery cable.

Always replace a blown fuse with one of the same rating.

If the replacement fuse blows, this indicates an electrical problem. Avoid using the system involved and immediately consult a professional workshop. Kia recommends to consult an authorised Kia dealer/service partner.

Three kinds of fuses are used: blade type for lower amperage rating, cartridge type, and multi fuse for higher amperage ratings.

⚠ WARNING**Fuse replacement**

- Never replace a fuse with anything but another fuse of the same rating.
- A higher capacity fuse could cause damage and possibly a fire.
- Never install a wire or aluminium foil instead of the proper fuse even as a temporary repair. It may cause extensive wiring damage and a possible fire.
- Do not arbitrarily modify or add on electric wiring of the vehicle.

⚠ CAUTION

Do not use a screwdriver or any other metal object to remove fuses because it may cause a short circuit and damage the system.

*** NOTICE**

- When replacing fuse, turn the ignition "OFF" and turn off switches of all electrical devices then remove battery (-) terminal.
- The actual fuse/relay panel label may differ from equipped items.

⚠ CAUTION

- When replacing a blown fuse or relay with a new one, make sure the new fuse or relay fits tightly

into the clips. The incomplete fastening fuse or relay may cause the vehicle wiring and electric systems damage and a possible fire.

- Do not remove fuses, relays and terminals fastened with bolts or nuts. The fuses, relays and terminals may be fastened incompletely, and it may cause a possible fire. If fuses, relays and terminals fastened with bolts or nuts are blown, consult a professional workshop. Kia recommends to consult an authorised Kia dealer/service partner.
- Do not input any other objects except fuses or relays into fuse/relay terminals such as a driver or wiring. It may cause contact failure and system malfunction.
- Do not plug in screwdrivers or aftermarket wiring into the terminal originally designed for fuse and relays only. The electrical system and wiring of the vehicle interior may be damaged or burned due to contact failure.
- If you directly connect the wire on the taillight or replace the bulb which is over the regulated capacity to install trailers etc., the inner junction block can get burned.

Inner panel fuse replacement

1. Turn the ignition switch or ENGINE START/STOP button and all other switches off.
2. Open the fuse panel cover.



3. Pull the suspected fuse straight out. Use the removal tool provided in the main fuse box in the engine compartment.

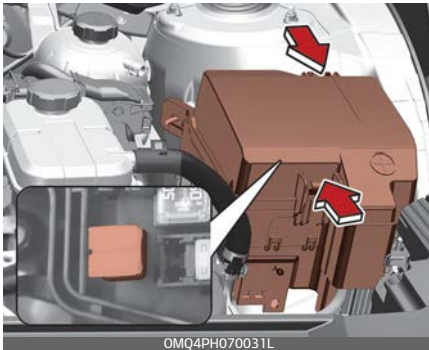

4. Check the removed fuse; replace it if it is blown.

Spare fuses are provided in the instrument panel fuse panel (or in the engine compartment fuse panel).

5. Push in a new fuse of the same rating, and make sure it fits tightly in the clips.

If it fits loosely, consult a professional workshop. Kia recommends to consult an authorised Kia dealer/service partner.

If you do not have a spare, use a fuse of the same rating from a circuit you may not need for operating the vehicle, such as the cigarette lighter fuse.

If the headlights or taillights, stoplights, courtesy lamp, day time running lights (DRL) do not work and the fuses are OK, consult a professional workshop. Kia recommends to consult an authorised Kia dealer/service partner.

Engine compartment fuse replacement

1. Turn the ignition switch or ENGINE START/STOP button and all other switches off.
2. Remove the fuse panel cover by pressing the tab and pulling the cover up.

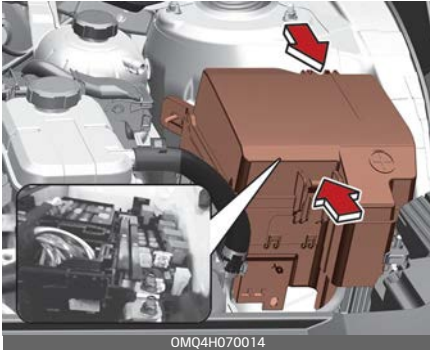

When the blade type fuse is disconnected, remove it by using the clip designed for changing fuses located in the engine room fuse box. Upon removal, securely insert reserve fuse of equal quantity.

3. Check the removed fuse; replace it if it is blown. To remove or insert the fuse, use the fuse puller in the engine compartment fuse panel.
4. Push in a new fuse of the same rating, and make sure it fits tightly in the clips. If it fits loosely, consult a professional workshop. Kia recommends to consult an authorised Kia dealer/service partner.

⚠ CAUTION

After checking the fuse panel in the engine compartment, securely install the fuse panel cover through the audible clicking sound.

If not, electrical failures may occur from water contact.

Main fuse (Multi fuse)

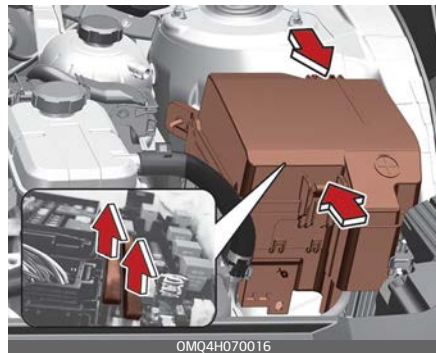

If the main fuse is blown, it must be removed as follows:

1. Turn off the engine.
2. Disconnect the negative battery cable.
3. Remove the nuts shown in the picture above.
4. Replace the fuse with a new one of the same rating.
5. Reinstall in the reverse order of removal.

*** NOTICE**

If the multi fuse is blown, consult a professional workshop. Kia recommends to consult an authorised Kia dealer/service partner.

*** NOTICE**

The electronic system may not function correctly even when the engine room and internal fuse box's individual fuses are not disconnected. In such case the cause of the problem may be disconnection of the main fuse. Since the main fuse is designed more intricately than other parts, visit a professional workshop. Kia recommends to visit the nearest authorised Kia dealer/service partner.

⚠ CAUTION

Visually inspect the battery cap for secure closing. If the battery cap is not securely latched, the electrical system may be damaged to due influx of moisture into the system.

Fuse/relay panel description

Inside the fuse/relay panel covers, you can find the fuse/relay label describing fuse/relay name and capacity.

*** NOTICE**

Not all fuse panel descriptions in this manual may be applicable to your vehicle. It is accurate at the time of printing. When you inspect the fuse panel in your vehicle, refer to the fuse panel label.

Driver's side fuse panel



USE THE DESIGNATED FUSE ONLY
استخدم الفيوز ذو القياس المناسب
Используйте только предназначенные предохранители
USE 30.0 LOS FUSIBLES ESPECIFICADOS











* 1: BEV ONLY



91990-P2640



Fuse #	Amperage	Component / Function	Amperage	Component / Function
01	30A	USB CHARGER	10A	10A
02	30A	USB CHARGER	15A	15A
03	25A	USB CHARGER	7.5A	7.5A
04	10A	MODUL	7.5A	7.5A
05	25A	MODUL	10A	10A
06	30A	REAR A/C	7.5A	7.5A
07	30A	REAR A/C	10A	10A
08	20A	SPARE	7.5A	7.5A
09	10A	REAR A/C	7.5A	7.5A
10	30A	SPARE	15A	15A
11	20A	SPARE	15A	15A
12	20A	SPARE	15A	15A
13	20A	SPARE	15A	15A
14	20A	SPARE	15A	15A
15	20A	SPARE	15A	15A
16	20A	SPARE	15A	15A
17	20A	SPARE	15A	15A
18	20A	SPARE	15A	15A
19	20A	SPARE	15A	15A
20	20A	SPARE	15A	15A
21	20A	SPARE	15A	15A
22	20A	SPARE	15A	15A
23	20A	SPARE	15A	15A
24	20A	SPARE	15A	15A
25	20A	SPARE	15A	15A
26	20A	SPARE	15A	15A
27	20A	SPARE	15A	15A
28	20A	SPARE	15A	15A
29	20A	SPARE	15A	15A
30	20A	SPARE	15A	15A
31	20A	SPARE	15A	15A
32	20A	SPARE	15A	15A
33	20A	SPARE	15A	15A
34	20A	SPARE	15A	15A
35	20A	SPARE	15A	15A
36	20A	SPARE	15A	15A
37	20A	SPARE	15A	15A
38	20A	SPARE	15A	15A
39	20A	SPARE	15A	15A
40	20A	SPARE	15A	15A
41	20A	SPARE	15A	15A
42	20A	SPARE	15A	15A
43	20A	SPARE	15A	15A
44	20A	SPARE	15A	15A
45	20A	SPARE	15A	15A
46	20A	SPARE	15A	15A
47	20A	SPARE	15A	15A
48	20A	SPARE	15A	15A
49	20A	SPARE	15A	15A
50	20A	SPARE	15A	15A
51	20A	SPARE	15A	15A
52	20A	SPARE	15A	15A
53	20A	SPARE	15A	15A
54	20A	SPARE	15A	15A
55	20A	SPARE	15A	15A
56	20A	SPARE	15A	15A
57	20A	SPARE	15A	15A
58	20A	SPARE	15A	15A
59	20A	SPARE	15A	15A
60	20A	SPARE	15A	15A



OMQ4PH070032L

ICU Junction Block

Fuse Name	Symbol	Fuse rating	Circuit Protected
AMP	AMP	25A	AMP (Amplifier)
LDC	LDC	30A	Not Used
P/SEAT(DRV)		30A	Driver Power Seat Switch, IMS (Integrated memory system) Control Module, Driver Lumbar Support Switch
OBC	OBC	10A	[PHEV] OBC (On-Board Charger)
P/WINDOW(LH)	LH 	25A	Driver/Passenger Safety Power Window Module, Passenger Power Window Switch, Rear Power Window Switch Left Handle side, Rear Safety Power Window Module Left Handle side
P/SEAT(PASS)		30A	[HEV] Passenger Power Seat Switch, Passenger Relay Unit, Passenger Power Seat Switch [PHEV] Passenger Power Seat Switch, Passenger Relay Unit
S/HEATER (FRT)		20A	1st Air Ventilation Seat Control Module, 1st Seat Warmer Control Module
S/HEATER (REAR LH)	REAR LH 	15A	2nd Seat Warmer Left Handle side Control Module
2nd ROW SEAT FOLDING(RH)	2nd RH 	20A	2nd Seat Right Handle side Folding Actuator
IG3 1	¹ IG3	20A	[PHEV] ICM Relay Box (IG3 Relay)
P/WINDOW (RH)	RH 	25A	Driver/Passenger Safety Power Window Module, Passenger Power Window Switch, Rear Power Window Switch Right Handle side, Rear Safety Power Window Module Right Handle side
TAILGATE OPEN		15A	Tailgate Relay
2nd ROW SEAT FOLDING(LH)	2nd LH 	20A	2nd Seat Warmer Left Handle side Control Module
DOOR LOCK		20A	[HEV] Door Lock/Unlock Relay, Dead Lock Relay, Data Link Connector [PHEV] Door Lock/Unlock Relay, Dead Lock Relay, Data Link Connector, ICM Relay Box (Fuel Lid Lock/Unlock Relay)
REAR A/C 2	² REAR A/C	10A	Rear Air Conditioner Control Module
MULTI MEDIA 1	¹ MULTI MEDIA	25A	Audio, Audio/Video & Navigation Head Unit, Fuse - MULTI MEDIA 2
E-CALL	E-CALL	10A	E-Call Unit
S/HEATER (REAR RH)	REAR RH 	15A	2nd Seat Warmer Right Handle side Control Module

Fuse Name	Symbol	Fuse rating	Circuit Protected
MEMORY	MEMORY	10A	[HEV] Power Tail Gate Unit, IMS (Integrated memory system) Control Module, Rear Air Conditioner Control Module, ROA (Rear Occupant Alert), Driver/Passenger Power Outside Mirror, DAU, Instrument Cluster, Rain Sensor, Front Air Conditioner Control Module, Front Air Conditioner Control Panel, Head-Up Display [PHEV] Power Tail Gate Unit, IMS (Integrated memory system) Control Module, Rear Air Conditioner Control Module, ROA (Rear Occupant Alert), Driver/Passenger Power Outside Mirror, Instrument Cluster, Rain Sensor, Front Air Conditioner Control Module, Front Air Conditioner Control Panel, Head-Up Display
START		10A	Ignition Switch
E-SHIFTER	E-SHIFTER	7.5A	Electronic Shift Dial
MODULE 6	MODULE	7.5A	Not Used
USB CHARGER 1	¹ USB CHARGER	10A	Luggage USB Charge Connector Left Handle side/Right Handle side
USB CHARGER 2	² USB CHARGER	15A	Rear Console USB Charge Connector Left Handle side/Right Handle side, Driver/Passenger Seat USB Charge Connector
CHARGER LOCK	CHARGER LOCK	10A	[PHEV] ICM Relay Box (Charger Connector Lock/Unlock Relay), Charger Door Lock Module
MODULE 3	³ MODULE	7.5A	[HEV] IBU (Integrated Body Control Unit), ADAS Unit, Front View Camera, Crash Pad Switch, Surround View Monitor Unit, Rear Corner Radar LH/RH, 4WD (4 Wheel Drive) ECU (Electronic Control Unit), Front View Camera, VESS (Virtual Engine Sound System) Unit, Front Console Switch, Driver/Passenger Seat Ventilation Switch [PHEV] IBU (Integrated Body Control Unit), ADAS Unit, Front View Camera, Crash Pad Switch, Surround View Monitor Unit, Rear Corner Radar LH/RH, 4WD (4 Wheel Drive) ECU (Electronic Control Unit), Front Radar, VESS (Virtual Engine Sound System) Unit, Front Console Switch, Driver/Passenger Seat Ventilation Switch Left Handle side/Right Handle side
AIR BAG 1	¹ 	15A	SRS (Supplemental Restraint System) Control Module
WASHER		15A	Multifunction Switch
MODULE 1	¹ MODULE	10A	AMP (Amplifier), RSE Left Handle side/Right Handle side, Audio, Audio/Video & Navigation Head Unit, IBU (Integrated Body Control Unit), Front USB Charge Connector Left Handle side/Right Handle side, ADAS Unit, E-Call Unit, Surround View Monitor Unit

Fuse Name	Symbol	Fuse rating	Circuit Protected
MODULE 9	⁹ MODULE	10A	[HEV] Key Solenoid, Driver/Passenger Mood Lamp, ADAS Unit, Data Link Connector, Surround View Monitor Unit, DAU, Driver/Passenger Smart Key Outside Handle, Mood Lamp Unit, UIP, BBS, Driver/Passenger Door Mood Lamp Unit [PHEV] Driver/Passenger Mood Lamp, ADAS Unit, Data Link Connector, Surround View Monitor Unit, Driver Door Area Unit, Rain Sensor, Driver/Passenger Smart Key Outside Handle, Mood Lamp Unit, UIP Sensor, Backup Battery Siren, Driver/Passenger Door Mood Lamp Unit
IBU 1	¹ IBU	7.5A	[HEV] IBU (Integrated Body Control Unit), Engine Room Junction Block (Battery C/Fan Relay), BMS (Battery Management System) Control Module [PHEV] IBU (Integrated Body Control Unit)
MODULE 2	² MODULE	7.5A	[HEV] DAU, Overhead Console, Multifunction Switch (R-MDPS) [PHEV] Driver Door Area Unit, Overhead Console, Multifunction Switch (R-MDPS) * MDPS (Motor Driven Power Steering) is the same as EPS (Electric Power Steering).
REAR A/C 1	¹ REAR A/C	15A	Rear Air Conditioner Blower Motor, ICU Junction Block (Fuse - REAR A/C 2)
A/BAG IND		7.5A	Instrument Cluster, Overhead Console
MODULE 8	⁸ MODULE	7.5A	ADAS Unit, 1st Air Ventilation Seat Control Module, 1st Seat Warmer Control Module, 2nd Seat Warmer Left Handle side/Right Handle side Control Module, Rear Air Conditioner Control Module
IBU 2	² IBU	15A	IBU (Integrated Body Control Unit)
MODULE 10	¹⁰ MODULE	10A	Stop Lamp Switch
MODULE 5	⁵ MODULE	10A	Overhead Console, AMP (Amplifier), Front Wireless Charger Unit
A/C	A/C	7.5A	[HEV] Front Air Conditioner Control Panel, Front Air Conditioner Control Module, Electronic Air Conditioner Compressor, Engine Room Junction Block (PTC Heater #1 Relay, PTC Heater #2 Relay, Blower Relay) [PHEV] Front Air Conditioner Control Panel, Front Air Conditioner Control Module, Engine Room Junction Block (PTC Heater #1 Relay, PTC Heater #2 Relay, Blower Relay)
AIR BAG 2	² 	10A	SRS (Supplemental Restraint System) Control Module
CLUSTER	CLUSTER	7.5A	Instrument Cluster, Head-Up Display

Fuse Name	Symbol	Fuse rating	Circuit Protected
MODULE 4	⁴ MODULE	10A	[HEV] E-Call Unit, Audio, Audio/Video & Navigation Head Unit, Data Link Connector, Front Air Conditioner Control Panel, Front Air Conditioner Control Module, Crash Pad Switch, Electro Chromic Mirror, Head Lamp Left Handle side/Right Handle side, IMS (Integrated memory system) Control Module, 1st Air Ventilation Seat Control Module, 1st Seat Warmer Control Module, 2nd Seat Warmer Left Handle side/Right Handle side Control Module [PHEV] E-Call Unit, Audio, Audio/Video & Navigation Head Unit, Data Link Connector, Crash Pad Switch, Electro Chromic Mirror, Head Lamp Left Handle side/Right Handle side, IMS (Integrated memory system) Control Module, 1st Air Ventilation Seat Control Module, 1st Seat Warmer Control Module, 2nd Seat Warmer Left Handle side/Right Handle side Control Module
IG3 3	³ IG3	10A	[PHEV] HPCU, SBW Control Unit
MODULE 7	⁷ MODULE	7.5A	IBU (Integrated Body Control Unit)
MULTI MEDIA 2	² MULTI MEDIA	10A	[HEV] RSE Left Handle side/Right Handle side [PHEV] Rear Seat Entertainment Left Handle side/Right Handle side
BRAKE SWITCH	 BRAKE SWITCH	7.5A	Stop Lamp Switch, IBU (Integrated Body Control Unit)
MDPS	 1	7.5A	MDPS (Motor Driven Power Steering) Unit * MDPS (Motor Driven Power Steering) is the same as EPS (Electric Power Steering).
IG3 2	² IG3	10A	[PHEV] Instrument Cluster, Front Air Conditioner Control Panel, Front Air Conditioner Control Module
IG3 4	⁴ IG3	15A	[PHEV] Electronic Water Pump

Engine compartment fuse panel

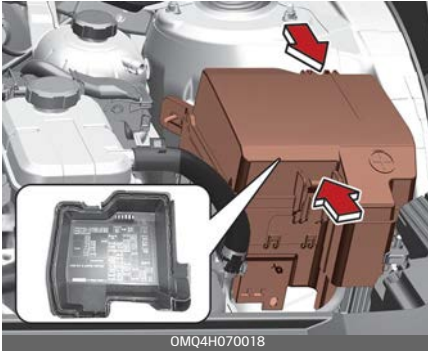





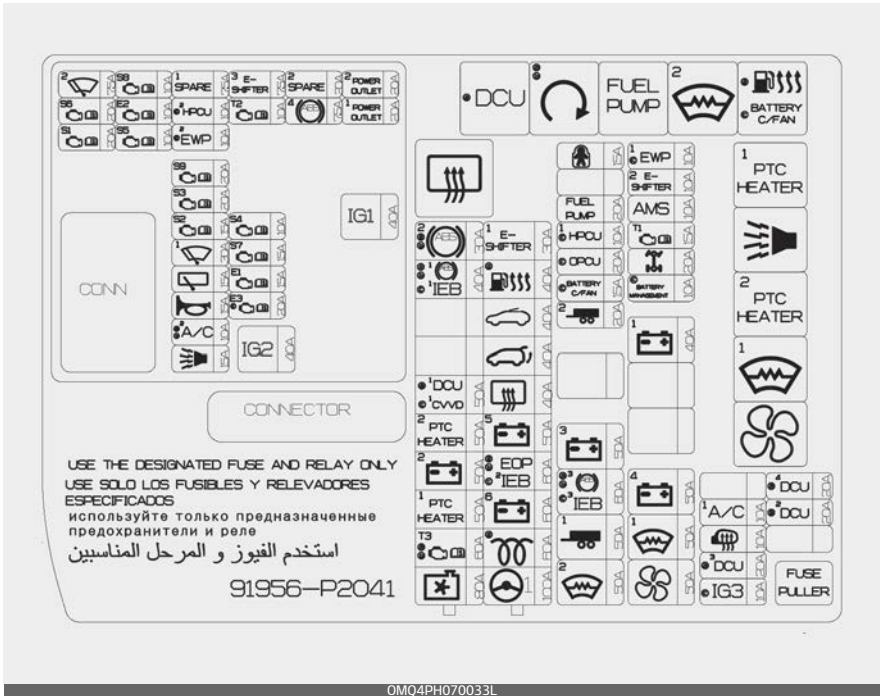









* NOTICE

Not all fuse panel descriptions in this manual may be applicable to your vehicle. It is accurate at the time of printing. When you inspect the fuse panel in your vehicle, refer to the fuse panel label on the inside of the fuse cover. This diagram will provide you with the specific information for your vehicles.









Engine Room Junction Block

Fuse Name	Symbol	Fuse rating	Circuit Protected
COOLING FAN		80A	Cooling Fan Motor
PTC HEATER1	¹ PTC HEATER	50A	PTC Heater #1 Relay
B+2	² 	50A	ICU Junction Block (Instrument Panel Module)
PTC HEATER2	² PTC HEATER	50A	PTC Heater #2 Relay
CVVD1	¹ CVVD	50A	CVD Actuator
IEB1	¹ IEB	40A	IEB Unit
MDPS1	 1	100A	MDPS (Motor Driven Power Steering) Unit * MDPS (Motor Driven Power Steering) is the same as EPS (Electric Power Steering).
B+6	⁶ 	60A	PCB Junction Block (Fuse - IG2, IG1)
IEB2	² IEB	60A	IEB Unit
B+5	⁵ 	50A	ICU Junction Block (Fuse - P/SEAT(DRV), P/WINDOW(LH), P/SEAT(PASS), S/HEATER (REAR LH), 2nd ROW SEAT FOLDING)
REAR HEATED		40A	Rear Heated Relay
POWER TAILGATE		40A	Power Tail Gate Unit
SUNROOF		40A	Sunroof Motor (Glass)
E-SHIFTER1	¹ E-SHIFTER	30A	SBW (Shift By Wire) Control Unit
TRAILER1	¹ 	50A	Trailer Module
IEB3	³ IEB	60A	IEB Unit
B+3	³ 	50A	ICU Junction Block (Instrument Panel Module)
TRAILER2	² 	20A	Trailer Module
BATTERY C/FAN	BATTERY C/FAN	15A	[HEV] Battery C/Fan Relay (Battery C/Fan Relay)
OPCU	OPCU	20A	OPU
HPCU1	¹ HPCU	10A	HPCU (Hybrid Power Control Unit)

Fuse Name	Symbol	Fuse rating	Circuit Protected
FUEL PUMP		20A	Fuel Pump Relay
CHILD LOCK		15A	PCB Junction Block (Child Lock/Unlock Relay)
BLOWER		50A	Blower Relay
B+4		50A	[HEV] ICU Junction Block (Fuse - AMP, S/HEATER (FRT), P/WINDOW (RH), 2nd ROW SEAT FOLDING(LH)) [PHEV] ICU Junction Block (Fuse - AMP, OBC, S/HEATER (FRT), IG3 1, P/WINDOW (RH), 2nd ROW SEAT FOLDING(LH))
B+1		40A	[HEV] ICU Junction Block (Fuse - TAILGATE OPEN, DOOR LOCK, MULTI MEDIA 1, S/HEATER (REAR RH), MEMORY, MODULE 9, IBU 2, AIR BAG 2, BRAKE SWITCH, Long Term Load Latch Relay) [PHEV] ICU Junction Block (Fuse - TAILGATE OPEN, DOOR LOCK, S/HEATER (REAR RH), MEMORY, START, MODULE 9, IBU 2, AIR BAG 2, BRAKE SWITCH, Long Term Load Latch Relay)
BATTERY MANAGEMENT		10A	BMS (Battery Management System) Control Module
4WD		20A	4WD (4 Wheel Drive) ECU (Electronic Control Unit)
TCU		15A	TCM (Transmission Control Module)
AMS	AMS	10A	Battery Sensor
E-SHIFTER2		10A	SBW (Shift By Wire) Control Unit
EWP1		10A	Electronic Water Pump
HEATED MIRROR		10A	[HEV] Front Air Conditioner Control Panel, Front Air Conditioner Control Module, Electronic Air Conditioner Compressor, Engine Room Junction Block (PTC Heater #1 Relay, PTC Heater #2 Relay, Blower Relay) [PHEV] Driver/Passenger Power Outside Mirror, Front Air Conditioner Control Panel
A/C1		10A	Not Used
W/S HEATED GLASS 1		50A	Not Used
W/S HEATED GLASS 2		50A	Not Used

PCB Block

Fuse Name	Symbol	Fuse rating	Circuit Protected
IG2	IG2	40A	Ignition switch2 Relay
IG1	IG1	40A	Ignition switch1 Relay, ACC Relay
WIPER2	²	7.5A	IBU (Integrated Body Control Unit)
SENSOR6	^{S6}	20A	Oxygen Sensor (Down)
SENSOR1	^{S1}	20A	Ignition Coil #1/#2/#3/#4
SENSOR8	^{S8}	10A	OPU
ECU2	^{E2}	10A	ECM (Engine Control Module), CVVD Actuator
SENSOR5	^{S5}	10A	Engine Room Junction Block (Fuel Pump Relay)
HPCU2	² HPCU	10A	HPCU (Hybrid Power Control Unit)
EWP2	² EWP	10A	Electronic Water Pump, Electronic Water Pump (HEV (Hybrid Electric Vehicle))
SENSOR9	^{S9}	20A	Not Used
SENSOR3	^{S3}	20A	ECM (Engine Control Module)
SENSOR2	^{S2}	15A	Active Purge Pump
WIPER1	¹	30A	Front Wiper Motor, Front Wiper (Low) Relay
REAR WIPER		15A	Rear Wiper Relay, Rear Wiper Motor
HORN		15A	Horn Relay
A/C	² A/C	10A	Not Used
B/A HORN		15A	Burglar Alarm Horn Relay
E-SHIFTER3	³ E-SHIFTER	7.5A	SBW (Shift By Wire) Control Unit
TCU2	^{T2}	10A	TCM (Transmission Control Module)

Fuse Name	Symbol	Fuse rating	Circuit Protected
SENSOR4		10A	[HEV] Purge Control Solenoid Valve, Oil Control Valve #1/#2 (Intake/Exhaust), Oil Pump Solenoid Valve, RCV (Recirculation Valve Control) Control Solenoid Valve, Cooling Fan Motor [PHEV] Purge Control Solenoid Valve, Oil Control Valve #1/#2 (Intake/Exhaust), Oil Pump Solenoid Valve, RCV (Recirculation Valve Control) Control Solenoid Valve, ELCM (Evap. Leak Check Module)
SENSOR7		15A	Oxygen Sensor (Up)
ECU1		15A	ECM (Engine Control Module)
ECU3		20A	ECM (Engine Control Module)
ABS4		7.5A	IEB Unit
POWER OUTLET2		20A	Rear Console Power Outlet
POWER OUTLET1		20A	Luggage Power Outlet

Relay

Refer to the following table for the relay type.

Relay Name	Type
Fuel Pump Relay	MICRO
Battery C/Fan Relay	MICRO
PTC Heater #1 Relay	MICRO
B/Alarm Horn Relay	MICRO
PTC Heater #2 Relay	MICRO
Blower Relay	MICRO
Rear Heated Relay	MINI

Engine compartment fuse panel (Battery terminal cover)



OMQ4H070015

A diagram of a fuse panel. At the top, a box contains the text "메인 150A" (Main 150A) and "MAIN". Below this, there are four lines of text in Korean, English, and Spanish, all instructing the user to use the designated fuse only. At the bottom, the part number "91975-P4010" is printed.

메인 150A
MAIN

지정된 퓨즈만 사용하세요
USE THE DESIGNATED FUSE ONLY
ИСПОЛЬЗУЙТЕ ТОЛЬКО ПРЕНАЗНАЧЕННЫЕ ПРЕДОХРАНИТЕЛИ
USE SOLO LOS FUSIBLES ESPECIFICADOS

91975-P4010

OMQ4H070019

Light bulbs

Bulb replacement precaution

Please prepare bulbs with appropriate standards in case of emergencies. Refer to "Bulb wattage" on page 9-6.

When changing bulbs and sorts, first turn off the engine at a safe place, firmly apply the side brake and take out the battery's negative (-) terminal.

⚠ WARNING

Working on the lights

Prior to working on the light, firmly apply the parking brake, ensure that the ignition switch or ENGINE START/STOP button is turned to the LOCK position and turn off the lights to avoid sudden movement of the vehicle and burning your fingers or receiving an electric shock.

Use only the bulbs of the specified wattage.

⚠ WARNING

Be sure to replace the burnedout bulb with one of the same wattage rating. Otherwise, it may cause extensive wiring damage and possible fire.

⚠ CAUTION

If you don't have necessary tools, the correct bulbs and the expertise, consult a professional workshop. Kia recommends to consult an authorised Kia dealer/service partner.

In many cases, it is difficult to replace vehicle light bulbs because other parts of the vehicle must be removed before you can get to the bulb. This is especially true if you have to remove the headlight assembly to get to the bulb(s). Removing/installing the headlight assembly can result in damage to the vehicle.

⚠ CAUTION

- If unauthentic parts or substandard lights are used when changing lights, it may lead to fuse disconnection and malfunction, and other wiring damages.
- Do not install extra lamps or LED to the vehicle. If supplementary lights are installed, it may lead to lamp malfunction and flickering of the lights. In addition, the fuse box and other wiring may be damaged.

Lamp part malfunction due to network failure

The headlamp, taillight, and fog light may lit up when the head lamp switch is turned ON, and not light up when the taillight or fog light switch is turned ON. This may be caused by network failure or vehicle electrical control system malfunction. If there is a problem, have the system serviced by a professional workshop. Kia recommends to visit an authorised Kia dealer/service partner.

Lamp part malfunction due to electrical control system stabilization

A normally functioning lamp may flicker momentarily. This momentary occurrence is due to stabilization function of the vehicle's electrical control system. If the lamp soon returns to normal, the vehicle does not require service.

However, if the lamp goes out after the momentary flickering, or the flickering continues, have the system serviced by a professional workshop. Kia recommends to visit an authorised Kia dealer/service partner.

*** NOTICE**

- If the light bulb or lamp connector is removed from an operating lamp activated by electricity, the fuse box's electronic device may scan it as a malfunction. Therefore, a lamp malfunction history may be recorded in Diagnostic Trouble Code (DTC) in the fuse box.
- It is normal for an operating lamp may blink temporarily. Since this occurrence is due to stabilization function of the vehicle's electronic control device, if the lamp lights up normally after temporary blinking, there is no problem in the vehicle.

However, if the lamp continues to blink several times or turn off completely, there may be an error in the vehicle's electronic control device. In this case, have the vehicle checked by a professional workshop immediately. Kia recommends to visit an authorised Kia dealer/service partner.

*** NOTICE**

After an accident or after the headlight assembly is reinstalled, have the headlight aiming adjusted by a professional workshop. Kia recommends to visit an authorised Kia dealer/service partner.

* NOTICE

Traffic Change

The low beam light distribution is asymmetric. If you go abroad to a country with opposite traffic direction, this asymmetric part will dazzle oncoming car driver. To prevent dazzle, ECE regulation demand several technical solutions (i.e. automatic change system, adhesive sheet, down aiming). This headlamps are designed not to dazzle opposite drivers. So, you need not change your headlamps in a country with opposite traffic direction.

* NOTICE

After driving in heavy rain or washing, headlamp and taillamp lenses could appear frosty. This condition is caused by the temperature difference between the lamp inside and outside. This is similar to the condensation on your windows inside your vehicle during the rain and doesn't indicate a problem with your vehicle. If the water leaks into the lamp bulb circuitry, have the vehicle checked by a professional workshop. Kia recommends to visit an authorised Kia dealer/service partner.

Light bulb position (Front)

Head lamp – Type A



Head lamp – Type B



Fog lamp



1. Headlamp (Low) (LED type)
2. Headlamp (High) (LED type)

- 3. Front turn signal lamp (Bulb type)
- 4. Front turn signal lamp (LED type)
- 5. Day time running lamp/Position lamp (LED type)
- 6. Front fog lamp (LED type)

Light bulb position (Rear)

Rear combination lamp - Type A



Rear combination lamp - Type B



Rear fog lamp



Reversing lamp



License plate lamp



High mounted stop lamp



1. Stop and tail lamp (Bulb type)
2. Rear turn signal lamp (Bulb type)
3. Stop and tail lamp (LED type)
4. Rear turn signal lamp (LED type)
5. Tail lamp (LED type)
6. License plate lamp (LED type)
7. High mounted stop lamp (LED type)
8. Rear fog lamp (LED type)
9. Reversing lamp (Bulb type)

Light bulb position (Side)



1. Side repeater lamp (LED type)

Replacing headlamp (Low beam/ High beam), position lamp/daytime running lamp, turn signal lamp (LED type)

Type A



Type B



If the head lamp LED (1,2), daytime running lamp LED (3) and turn signal lamp LED (4) does not operate, have your vehicle checked by a professional workshop. Kia recommends to visit an authorised Kia dealer/service partner.

Replacing front turn signal lamp (Bulb type)

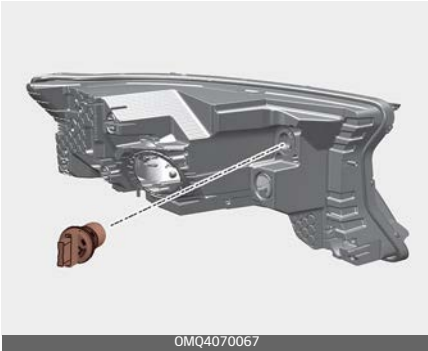

1. Turn off vehicle and disconnect the negative terminal from the battery.
2. Remove the socket (A) from the assembly by turning the socket counterclockwise until the tabs on the socket align with the slots on the assembly.

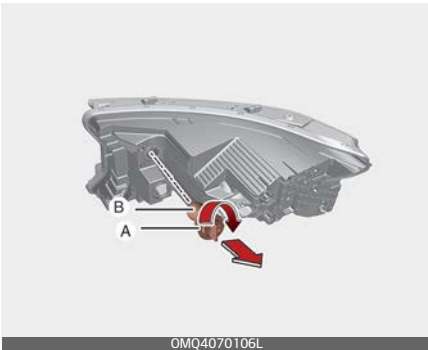

3. Remove the bulb (B) from the socket (A) by pressing it in and rotating it counterclockwise until the tabs on the bulb align with the slots in the socket. Pull the bulb out of the socket

4. Insert a new bulb by inserting it into the socket and rotating it until it locks into place.
5. Install the socket in the assembly by aligning the tabs on the socket with the slots in the assembly. Push the socket into the assembly and turn the socket clockwise.
6. Connect the negative terminal from the battery.

Replacing front fog lamp (LED type)

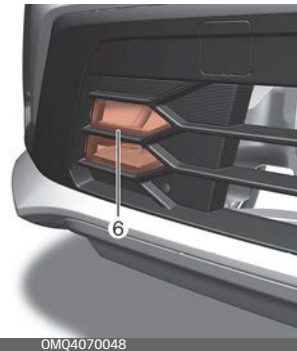

If the front fog lamp (6) does not operate, have your vehicle checked by a professional workshop. Kia recommends to visit an authorised Kia dealer/service partner.

Replacing side repeater lamp (LED type)



If the Side repeater lamp (LED) (1) does not operate, have your vehicle checked by a professional workshop.

Kia recommends to visit an authorised Kia dealer/service partner.

The LED lamp cannot be replaced as a single unit because it is an integrated unit. The LED lamp has to be replaced with the unit.

A skilled technician should check or repair the Side repeater lamp (LED), for it may damage related parts of the vehicle.

Replacing stop and tail lamp (Bulb type)



1. Turn off vehicle and disconnect the negative terminal from the battery.
2. Open the tailgate.
3. Open the service cover.
4. Loosen the light assembly retaining screws with a cross-tip screw driver.



5. Remove the rear combination lamp assembly from the body of the vehicle.
6. Disconnect the rear combination lamp connector.

7. Remove the socket from the assembly by turning the socket counterclockwise until the tabs on the socket align with the slots on the assembly.



8. Remove the bulb from the socket by pressing it in and rotating it counterclockwise until the tabs on the bulb align with the slots in the socket.
Pull the bulb out of the socket.
9. Insert a new bulb by inserting it into the socket and rotating it until it locks into place.
10. Install the socket in the assembly by aligning the tabs on the socket with the slots in the assembly. Push the socket into the assembly and turn the socket clockwise.
11. Install the rear combination lamp assembly to the body of the vehicle.
12. Install the service cover.

Replacing rear turn signal lamp (Bulb type)



1. Turn off vehicle and disconnect the negative terminal from the battery.
2. Open the tailgate.
3. Open the service cover.
4. Loosen the light assembly retaining screws with a cross-tip screw driver.



5. Remove the rear combination lamp assembly from the body of the vehicle.
6. Disconnect the rear combination lamp connector.

- Remove the socket from the assembly by turning the socket counterclockwise until the tabs on the socket align with the slots on the assembly.



- Remove the bulb from the socket by pressing it in and rotating it counterclockwise until the tabs on the bulb align with the slots in the socket. Pull the bulb out of the socket.
- Insert a new bulb by inserting it into the socket and rotating it until it locks into place.
- Install the socket in the assembly by aligning the tabs on the socket with the slots in the assembly. Push the socket into the assembly and turn the socket clockwise.
- Install the rear combination lamp assembly to the body of the vehicle.
- Install the service cover.

Replacing rear turn signal lamp, stop and tail lamp (LED type)



If the rear turn signal lamp (2), stop and tail lamp (1), and tail lamp (3) do not operate, have your vehicle checked by a professional workshop. Kia recommends to visit an authorised Kia dealer/service partner.

The LED lamp cannot be replaced as a single unit because it is an integrated unit. The LED lamp has to be replaced with the unit.

A skilled technician should check or repair the stop and tail lamp (LED), for it may damage related parts of the vehicle.

Replacing reversing lamp (bulb type)

1. Turn off vehicle and disconnect the negative terminal from the battery.
2. Remove the plastic tabs with a flat-tip screw driver.

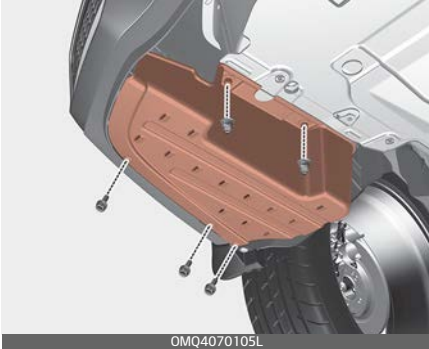

3. Loosen the plastic retaining screws and remove the under panel cover.
4. Disconnect the rear back up lamp connector (A).



5. Remove the socket (A) from the assembly by turning the socket counterclockwise until the tabs on the socket align with the slots on the assembly.



6. Remove the bulb from the socket by pressing it in and rotating it counterclockwise until the tabs on the bulb align with the slots in the socket. Pull the bulb out of the socket.
7. Insert a new bulb by inserting it into the socket and rotating it until it locks into place.
8. Install the socket in the assembly by aligning the tabs on the socket with the slots in the assembly. Push the socket into the assembly and turn the socket clockwise.
9. Connect the rear back up lamp connector.
10. Tighten the plastic retaining screws.
11. Install the plastic tabs and the under panel cover.

Replacing rear fog lamp (LED type)



If the rear fog lamp (1) does not operate, have your vehicle checked by a professional workshop. Kia recommends to visit an authorised Kia dealer/service partner. The LED lamp cannot be replaced as a single unit because it is an integrated unit. The LED lamp has to be replaced with the unit. A skilled technician should check or repair the stop and tail lamp (LED), for it may damage related parts of the vehicle.

Replacing high mounted stop lamp (LED type)



If the high mounted stop lamp (LED) (1) does not operate, have your vehicle checked by a professional workshop.

Kia recommends to visit an authorised Kia dealer/service partner.

The LED lamp cannot be replaced as a single unit because it is an integrated unit. The LED lamp has to be replaced with the unit.

A skilled technician should check or repair the high mounted stop lamp (LED), for it may damage related parts of the vehicle.

Replacing license plate lamp (LED type)



If the license plate lamp does not operate, we recommend that the system be checked by a professional workshop. Kia recommends to visit an authorised Kia dealer/service partner. The LED lamp cannot be replaced as a single unit because

it is an integrated unit. The LED lamp has to be replaced with the unit. A skilled technician should check or repair the map lamp (LED), for it may damage related parts of the vehicle.

Replacing map lamp (Bulb type)



⚠ WARNING

Prior to working on the Interior lamps, ensure that the "OFF" button is depressed to avoid burning your fingers or receiving an electric shock.

1. Turn off vehicle and disconnect the negative terminal from the battery.
2. Using a flat-blade screwdriver, gently pry the lens cover from lamp housing.
3. Remove the bulb by pulling it straight out.
4. Install a new bulb in the socket.
5. Align the lens cover tabs with the lamp housing notches and snap the lens into place.

⚠ CAUTION

Be careful not to dirty or damage the lens, lens tab, and plastic housings.

Replacing map lamp (LED type)



If the map lamp (LED) (1) does not operate, have your vehicle checked by a professional workshop.

Kia recommends to visit an authorised Kia dealer/service partner.

The LED lamp cannot be replaced as a single unit because it is an integrated unit. The LED lamp has to be replaced with the unit.

A skilled technician should check or repair the map lamp (LED), for it may damage related parts of the vehicle.

Replacing room lamp (Bulb type)

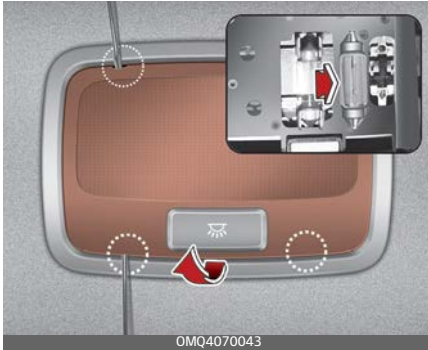

⚠ WARNING

Prior to working on the Interior lamps, ensure that the "OFF" button is depressed to avoid burning your fingers or receiving an electric shock.

1. Turn off vehicle and disconnect the negative terminal from the battery.
2. Using a flat-blade screwdriver, gently pry the lens cover from lamp housing.
3. Remove the bulb by pulling it straight out.
4. Install a new bulb in the socket.
5. Align the lens cover tabs with the lamp housing notches and snap the lens into place.

⚠ CAUTION

Be careful not to dirty or damage the lens, lens tab, and plastic housings.

Replacing personal lamp (LED type) (if equipped)

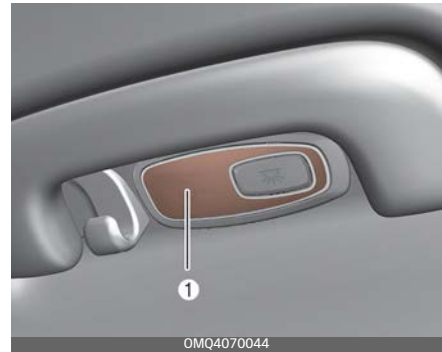

If the personal lamp (LED) (1) does not operate, have your vehicle checked by a professional workshop.

Kia recommends to visit an authorised Kia dealer/service partner.

The LED lamp cannot be replaced as a single unit because it is an integrated unit. The LED lamp has to be replaced with the unit.

A skilled technician should check or repair the personal lamp (LED), for it may damage related parts of the vehicle.

Replacing vanity mirror lamp (Bulb type)



⚠ WARNING

Prior to working on the Interior lamps, ensure that the "OFF" button is depressed to avoid burning your fingers or receiving an electric shock.

1. Turn off vehicle and disconnect the negative terminal from the battery.
2. Using a flat-blade screwdriver, gently pry the lamp assembly from interior.
3. Remove the bulb by pulling it straight out.
4. Install a new bulb in the socket.
5. Install the lamp assembly to interior.

⚠ CAUTION

Be careful not to dirty or damage the lens, lens tab, and plastic housings.

Replacing glove box lamp



1. Turn off vehicle and disconnect the negative terminal from the battery.
2. Using a flat-blade screwdriver, gently pry the lamp assembly from interior.
3. Remove the cover from the lamp assembly.
4. Remove the bulb by pulling it straight out.
5. Install a new bulb in the socket.
6. Install the cover to the lamp assembly.
7. Install the lamp assembly to interior.

⚠ CAUTION

Be careful not to dirty or damage the lens, lens tab, and plastic housings.

Replacing luggage lamp (Bulb type)

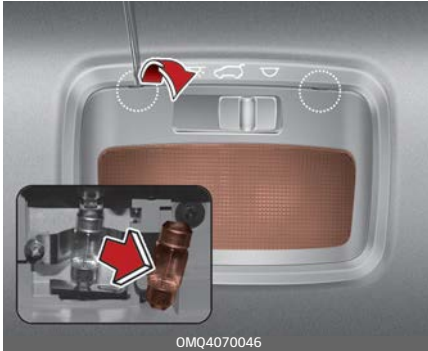

⚠ WARNING

Prior to working on the Interior lamps, ensure that the "OFF" button is depressed to avoid burning your fingers or receiving an electric shock.

1. Turn off vehicle and disconnect the negative terminal from the battery.
2. Using a flat-blade screwdriver, gently pry the lamp assembly from interior.
3. Remove the cover from the lamp assembly.
4. Remove the bulb by pulling it straight out.
5. Install a new bulb in the socket.
6. Install the cover to the lamp assembly.
7. Install the lamp assembly to interior.

⚠ CAUTION

Be careful not to dirty or damage the lens, lens tab, and plastic housings.

Replacing luggage lamp (LED type)



If the luggage lamp bulb/LED does not operate, we recommend that the system be checked by a professional workshop.

Headlamp and front fog lamp aiming

Headlamp aiming

Bulb type

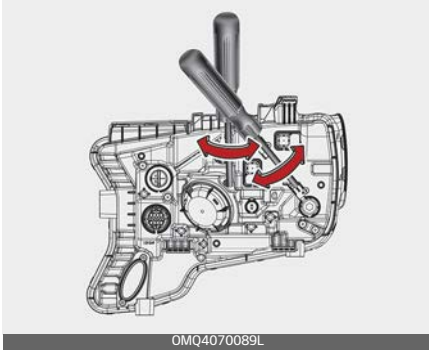

LED type

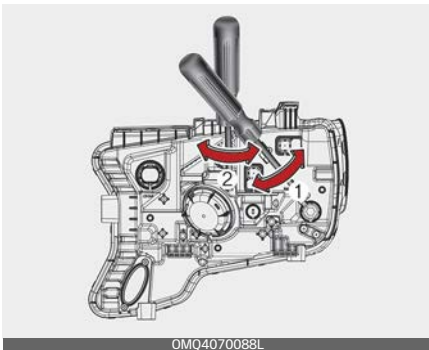

1. Inflate the tyres to the specified pressure and remove any loads from the vehicle except the driver, spare tyre, and tools.
2. The vehicle should be placed on a flat floor.
3. Draw vertical lines (Vertical lines passing through respective head lamp centres) and a horizontal line (Horizontal line passing

through centre of head lamps) on the screen.

4. With the head lamp and battery in normal condition, aim the head lamps so the brightest portion falls on the horizontal and vertical lines.
5. To aim the low beam left or right, turn the driver (1) clockwise or counterclockwise. To aim the low beam up or down, turn the driver (2) clockwise or counterclockwise.

Front fog lamp aiming (if equipped)



- The front fog lamp can be aimed in the same manner as the head lamps aiming.
- With the front fog lamps and battery in normal condition, aim the front fog lamps.
- To aim the front fog lamp up or down, turn the driver clockwise or counterclockwise.

Aiming point

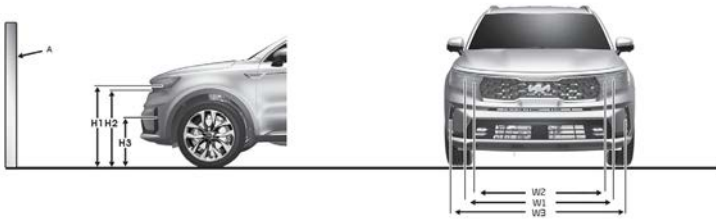

OMQ4071087L

* A: Screen

Vehicle condition		Head lamp (LED type)				Front Fog lamp (LED type) (if equipped)	
		Ground Height		Distance between lamps		Ground Height	Distance between lamps
		Low/High beam		Low/High beam			
		H1	H2	W1	W2	H3	W3
without driver [mm (in)]	Type A	887 (34.9)	870 (34.2)	1,536 (60.5)	1,316 (51.8)	408 (10.3)	1,092 (27.7)
	Type B	879 (22.3)	862 (33.9)	1,482 (37.6)	1,237 (60.5)		
with driver [mm (in)]	Type A	880 (34.6)	863 (34.0)	1,536 (60.5)	1,536 (51.8)	401 (10.1)	1,092 (27.7)
	Type B	872 (22.1)	855 (33.7)	1,482 (37.6)	1,536 (60.5)		

Head lamp low beam (LHD Vehicle)

Based on 10m screen

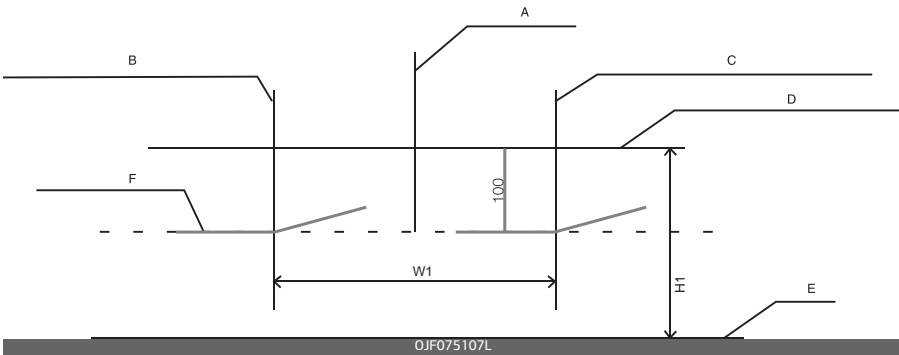

A: Vehicle axis

B: Vertical line of the left head lamp bulb centre

C: Vertical line of the right head lamp bulb centre

D: Horizontal line of head lamp bulb centre

E: Ground

F: Cut-Off line

1. Turn the low beam on without driver aboard.
2. The cut-off line should be projected in the cut-off line shown in the picture.
3. When aiming the low beam, vertical aiming should be adjusted after adjusting the horizontal aiming.
4. If head lamp levelling device is equipped, adjust the head lamp levelling device switch with 0 positions.

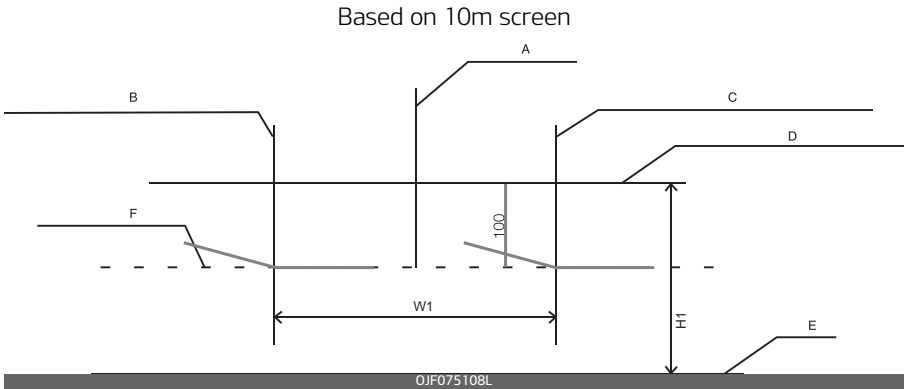
Head lamp low beam (RHD Vehicle)

A: Vehicle axis

B: Vertical line of the left head lamp bulb centre

C: Vertical line of the right head lamp bulb centre

D: Horizontal line of head lamp bulb centre

E: Ground

F: Cut-Off line

1. Turn the low beam on without driver aboard.
2. The cut-off line should be projected in the cut-off line shown in the picture.
3. When aiming the low beam, vertical aiming should be adjusted after adjusting the horizontal aiming.
4. If head lamp levelling device is equipped, adjust the head lamp levelling device switch with 0 positions.

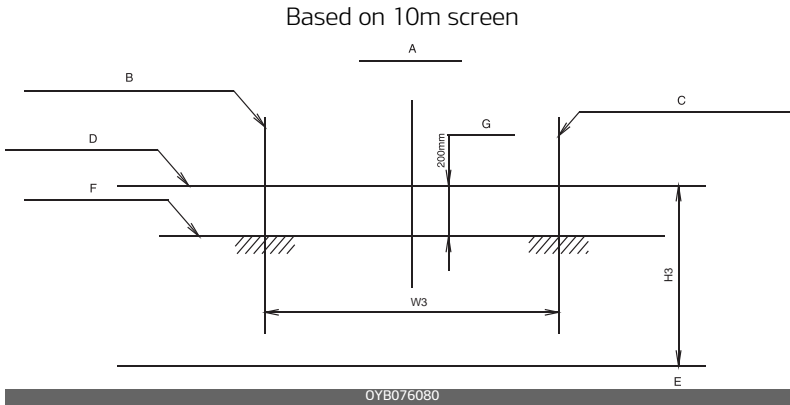
Front fog lamp

A: Vehicle axis

B: Vertical line of the left fog lamp bulb centre

C: Vertical line of the right fog lamp bulb centre

D: Horizontal line of fog lamp bulb centre

E: Ground

F: Cut-Off line

G: Upper limit

1. Turn the front fog lamp on without the driver aboard.
2. The cut-off line should be projected in the allowable range (shaded region).

Appearance care

Exterior care

Exterior general caution

It is very important to follow the label directions when using any chemical cleaner or polish. Read all warning and caution statements that appear on the label.

* NOTICE

If you park the vehicle around a stainless signboard or windscreen building etc., the plastic exterior trim (bumper, spoiler, garnish, lamp, outside mirror etc.) may be damaged by reflected sunlight from the external structure. To avoid damaging the plastic exterior trim, park the vehicle away from the areas where the reflected light may occur or use a vehicle cover. (Depending on the vehicle, the type of exterior trim applied such as spoiler may differ.)

Finish maintenance

Washing

To help protect your vehicle's finish from rust and deterioration, wash it thoroughly and frequently at least once a month with lukewarm or cold water.

If you use your vehicle for off-road driving, you should wash it after

each off-road trip. Pay special attention to the removal of any accumulation of salt, dirt, mud, and other foreign materials. Make sure the drain holes in the lower edges of the doors and rocker panels are kept clear and clean. Insects, tar, tree sap, bird droppings, industrial pollution and similar deposits can damage your vehicle's finish if not removed immediately.

Even prompt washing with plain water may not completely remove all these deposits. A mild soap, safe for use on painted surfaces, may be used. After washing, rinse the vehicle thoroughly with lukewarm or cold water. Do not allow soap to dry on the finish.

⚠ CAUTION

- Do not use strong soap, chemical detergents or hot water, and do not wash the vehicle in direct sunlight or when the body of the vehicle is warm.
- Be careful when washing the side windows of your vehicle. Especially, with high-pressure water, water may leak through the windows and wet the interior.
- To prevent damage to the plastic parts and lamps, do not clean with chemical solvents or strong detergents.

⚠ WARNING

Wet brakes

After washing the vehicle, test the brakes whilst driving slowly to see if they have been affected by water. If braking performance is impaired, dry the brakes by applying them lightly whilst maintaining a slow forward speed.

High-pressure washing

- When using high-pressure washers, make sure to maintain sufficient distance from the vehicle. Insufficient clearance or excessive pressure can lead to component damage or water penetration.
- Do not spray the camera, sensors or its surrounding area directly with a high pressure washer. Shock applied from high pressure water may cause the device to not operate normally.
- Do not bring the nozzle tip close to boots (rubber or plastic covers) or connectors as they may be damaged if they come into contact with high pressure water.



OMQ4071086L

⚠ CAUTION

- Water washing in the engine compartment including high pressure water washing may cause the failure of electrical circuits located in the engine compartment.
- Never allow water or other liquids to come in contact with electrical/electronic components inside the vehicle as this may damage them.

Waxing

Wax the vehicle when water will no longer bead on the paint. Always wash and dry the vehicle before waxing. Use a good quality liquid or paste wax, and follow the manufacturer's instructions. Wax all metal trim to protect it and to maintain its luster. Removing oil, tar, and similar materials with a spot remover will usually strip the wax from the finish. Be sure to re-wax these areas even if the rest of the vehicle does not yet need waxing. Do not apply wax on

embossed unpainted unit, as it may tarnish the unit.

▲ CAUTION

- Wiping dust or dirt off the body with a dry cloth will scratch the finish.
- Do not use steel wool, abrasive cleaners, acid detergents or strong detergents containing high alkaline or caustic agents on chrome-plated or anodised aluminium parts. This may result in damage to the protective coating and cause discolouration or paint deterioration.

Finish damage repair

Deep scratches or stone chips in the painted surface must be repaired promptly. Exposed metal will quickly rust and may develop into a major repair expense.

*** NOTICE**

If your vehicle is damaged and requires any metal repair or replacement, be sure the body shop applies anti-corrosion materials to the parts repaired or replaced.

Bright-metal maintenance

- To remove road tar and insects, use a tar remover, not a scraper or other sharp object.
- To protect the surfaces of bright-metal parts from corrosion, apply a coating of wax or chrome preservative and rub to a high luster.
- During winter weather or in coastal areas, cover the bright metal parts with a heavier coating of wax or preservative. If necessary, coat the parts with non-corrosive petroleum jelly or other protective compound.

Underbody maintenance

Corrosive materials used for ice and snow removal and dust control may collect on the underbody. If these materials are not removed, accelerated rusting can occur on underbody parts such as the fuel lines, frame, floor pan and exhaust system, even though they have been treated with rust protection.

Thoroughly flush the vehicle underbody and wheel openings with lukewarm or cold water once a month, after off-road driving and at the end of each winter. Pay special attention to these areas because it is difficult to see all the mud and dirt. It will do more harm than good to wet down the road grime without removing it. The lower edges of the

doors, rocker panels, and frame members have drain holes that should not clog with dirt; trapped water in these areas can cause rusting.

WARNING

After washing the vehicle, test the brakes whilst driving slowly to see if they have been affected by water. If braking performance is impaired, dry the brakes by applying them lightly whilst maintaining a slow forward speed.

Aluminium wheel maintenance

The aluminium wheels are coated with a clear protective finish.

- Do not use any abrasive cleaner, polishing compound, solvent, or wire brushes on aluminium wheels. They may scratch or damage the finish.
- Clean the wheel when it has cooled.
- Use only a mild soap or neutral detergent, and rinse thoroughly with water. Also, be sure to clean the wheels after driving on salted roads. This helps prevent corrosion.
- Avoid washing the wheels with high-speed car wash brushes.
- Do not use any alkaline or acid detergent. It may damage and corrode the aluminium wheels

coated with a clear protective finish.

Corrosion protection

Protecting your vehicle from corrosion

By using the most advanced design and construction practices to combat corrosion, we produce vehicles of the highest quality. However, this is only part of the job. To achieve the longterm corrosion resistance your vehicle can deliver, the owner's cooperation and assistance is also required.

Common causes of corrosion

The most common causes of corrosion on your vehicle are:

- Road salt, dirt and moisture that is allowed to accumulate underneath the vehicle.
- Removal of paint or protective coatings by stones, gravel, abrasion or minor scrapes and dents which leave unprotected metal exposed to corrosion.

High-corrosion areas

If you live in an area where your vehicle is regularly exposed to corrosive materials, corrosion protection is particularly important. Some of the common causes of accelerated corrosion are road salts, dust control chemicals, ocean air and industrial pollution.

Moisture breeds corrosion

Moisture creates the conditions in which corrosion is most likely to occur. For example, corrosion is accelerated by high humidity, particularly when temperatures are just above freezing. In such conditions, the corrosive material is kept in contact with the vehicle's surface by moisture that evaporate slowly. Mud is particularly corrosive because it dries slowly and holds moisture in contact with the vehicle. Although the mud appears to be dry, it can still retain moisture and promote corrosion. High temperatures can also accelerate corrosion of parts that are not properly ventilated so the moisture can be dispersed.

For all these reasons, it is particularly important to keep your vehicle clean and free of mud or accumulations of other materials. This applies not only to the visible surfaces but particularly to the underside of the vehicle.

To help prevent corrosion

You can help prevent corrosion from getting started by observing the following:

Keep your vehicle clean

The best way to prevent corrosion is to keep your vehicle clean and free of corrosive materials. Attention to the underside of the vehicle is particularly important.

- If you live in a high-corrosion area – where road salts are used, near the ocean, areas with industrial pollution, acid rain, etc., you should take extra care to prevent corrosion. In winter, hose off the underside of your vehicle at least once a month and be sure to clean the underside thoroughly when winter is over.
- When cleaning underneath the vehicle, give particular attention to the components under the fenders and other areas that are hidden from view. Do a thorough job; just dampening the accumulated mud rather than washing it away will accelerate corrosion rather than prevent it. Water under high pressure and steam are particularly effective in removing accumulated mud and corrosive materials.
- When cleaning lower door panels, rocker panels and frame members, be sure that drain holes are kept open so that moisture can escape and not be trapped inside to accelerate corrosion.

Keep your garage dry

Don't park your vehicle in a damp, poorly ventilated garage. This creates a favourable environment for corrosion. This is particularly true if you wash your vehicle in the garage or drive it into the garage when it is

still wet or covered with snow, ice or mud. Even a heated garage can contribute to corrosion unless it is well ventilated so moisture is dispersed.

Keep paint and trim in good condition

Scratches or chips in the finish should be covered with "touch-up" paint as soon as possible to reduce the possibility of corrosion. If bare metal is showing through, the attention of a qualified body and paint shop is recommended.

Bird droppings: Bird droppings are highly corrosive and may damage painted surfaces in just a few hours. Always remove bird droppings as soon as possible.

Don't neglect the interior

Moisture can collect under the floor mats and carpeting and cause corrosion. Check under the mats periodically to be sure the carpeting is dry. Use particular care if you carry fertilisers, cleaning materials or chemicals in the vehicle.

These should be carried only in proper containers and any spills or leaks should be cleaned up, flushed with clean water and thoroughly dried.

Interior care

Interior general precautions

Prevent chemicals such as perfume, cosmetic oil, sun cream, hand cleaner, and air freshener from contacting the interior parts because they may cause damage or discolouration. If they do contact the interior parts, wipe them off immediately. If necessary, use a mixture of warm water and mild non-detergent cleaner (test all cleaners on a concealed area before use).

⚠ CAUTION

Never allow water or other liquids to come in contact with electrical/electronic components inside the vehicle as this may damage them.

⚠ CAUTION

When cleaning leather products (steering wheel, seats etc.), use neutral detergents or low alcohol content solutions. If you use high alcohol content solutions or acid/alkaline detergents, the colour of the leather may fade or the surface may get stripped off.

Taking care of leather seats

- Vacuum the seat periodically to remove dust and sand on the seat. It will prevent abrasion or damage of the leather and maintain its quality.
- Wipe the natural leather seat cover often with dry or soft cloth.
- Sufficient use of a leather protective may prevent abrasion of the cover and helps maintain the colour. Be sure to read the instructions and consult a specialist when using leather coating or protective agents.
- Leather with bright colours (beige, cream beige) is easily contaminated and clear in appearance. Clean the seats frequently.
- Avoid wiping with wet cloth. It may cause the surface to crack.

Cleaning the leather seats

- Remove all contaminations instantly. Refer to instructions below for removal of each contaminant.
- Cosmetic products (sunscreen, foundation, etc.)
 - Apply cleansing cream on a cloth and wipe the contaminated point. Wipe off the cream with a wet cloth and remove water with a dry cloth.
- Beverages (coffee, soft drink, etc.)

- Apply a small amount of neutral detergent and wipe until contaminations do not smear.
- Oil
 - Remove oil instantly with absorbable cloth and wipe with stain remover for natural leather only.
- Chewing gum
 - Harden the gum with ice and remove gradually.

Fabric seat cover using precautions (if equipped)

Please clean the fabric seats regularly with a vacuum cleaner in consideration of fabric material characteristics. If they are heavily soiled with beverage stains, etc., use a suitable interior cleaner. To prevent damage to seat covers, wipe off the seat covers down to the seams with a large wiping motion and moderate pressure using a soft sponge or microfiber cloth.

Velcro closures on clothing or sharp objects may cause snagging or scratches on the surface of the seats. Make sure not to rub such objects against the surface.

Cleaning the upholstery and interior trim

Car interior surfaces

Remove dust and loose dirt from interior surfaces with a whisk broom or a vacuum cleaner. If necessary, clean interior surfaces with a mixture of warm water and mild non-detergent cleaner (test all cleaners on a concealed area before use).

Fabric

Remove dust and loose dirt from fabric with a whisk broom or vacuum cleaner. Clean with a mild soap solution recommended for upholstery or carpets. Remove fresh spots immediately with a fabric spot cleaner. If fresh spots do not receive immediate attention, the fabric can be stained and its colour can be affected. Also, its fire-resistant properties can be reduced if the material is not properly maintained.

⚠ CAUTION

Using anything but recommended cleaners and procedures may affect the fabric's appearance and fire-resistant properties.

Cleaning the lap/shoulder belt webbing

Clean the belt webbing with any mild soap solution recommended for cleaning upholstery or carpet. Follow the instructions provided with the soap. Do not bleach or re-dye the webbing because this may weaken it.

Cleaning the interior window glass

If the interior glass surfaces of the vehicle become fogged (that is, covered with an oily, greasy or waxy film), they should be cleaned with a glass cleaner. Follow the directions on the glass cleaner container.

⚠ CAUTION

Do not scrape or scratch the inside of the rear window. This may result in damage of the rear window defroster grid.

Emission control system (if equipped)

The emission control system of your vehicle is covered by a written limited warranty. Please see the warranty information contained in the Warranty & Maintenance book in your vehicle.

Your vehicle is equipped with an emission control system to meet all applicable emission regulations.

There are three emission control systems, as follows.

1. Crankcase emission control system
2. Evaporative emission control system
3. Exhaust emission control system

In order to assure the proper function of the emission control systems, have your vehicle inspected and maintained by a professional workshop in accordance with the maintenance schedule in this manual. Kia recommends to visit an authorised Kia dealer/service partner.

Caution for the Inspection and Maintenance Test (With Electronic Stability Control (ESC) system)

- **To prevent the vehicle from misfiring during dynamometer testing, turn the Electronic Stability Control (ESC) system off by pressing the ESC switch.**

- **After dynamometer testing is completed, turn the ESC system back on by pressing the ESC switch again.**

1. Crankcase emission control system

The positive crankcase ventilation system is employed to prevent air pollution caused by blow-by gases being emitted from the crankcase. This system supplies fresh filtered air to the crankcase through the air intake hose. Inside the crankcase, the fresh air mixes with blow-by gases, which then pass through the PCV valve into the induction system.

2. Evaporative emission control system

The Evaporative Emission Control System is designed to prevent fuel vapours from escaping into the atmosphere.

Canister

Fuel vapours generated inside the fuel tank are absorbed and stored in the onboard canister. When the engine is running, the fuel vapours absorbed in the canister are drawn into the surge tank through the purge control solenoid valve.

Purge Control Solenoid Valve (PCSV)

The purge control solenoid valve is controlled by the Engine Control Module (ECM); when the engine

coolant temperature is low during idling, the PCSV closes so that evaporated fuel is not taken into the engine. After the engine warms up during ordinary driving, the PCSV opens to introduce evaporated fuel to the engine.

3. Exhaust emission control system

The Exhaust Emission Control System is a highly effective system which controls exhaust emissions whilst maintaining good vehicle performance.

Engine exhaust gas precautions (carbon monoxide)

- Carbon monoxide can be present with other exhaust fumes. Therefore, if you smell exhaust fumes of any kind inside your vehicle, have it inspected and repaired immediately. If you ever suspect exhaust fumes are coming into your vehicle, drive it only with all the windows fully open. Have your vehicle checked and repaired immediately.

WARNING

Exhaust

Engine exhaust gases contain carbon monoxide (CO). Though colourless and odourless, it is dangerous and could be lethal if inhaled. Follow the instructions on this page to avoid CO poisoning.

- Do not operate the engine in confined or closed areas (such as garages) any more than what is necessary to move the vehicle in or out of the area.
- When the vehicle is stopped in an open area for more than a short time with the engine running, adjust the ventilation system (as needed) to draw outside air into the vehicle.
- Never sit in a parked or stopped vehicle for any extended time with the engine running.
- When the engine stalls or fails to start, excessive attempts to restart the engine may cause damage to the emission control system.

Operating precautions for catalytic converters (if equipped)

WARNING

Fire

- A hot exhaust system can ignite flammable items under your vehicle. Do not park the vehicle over or near flammable objects, such as grass, vegetation, paper, leaves, etc.
- The exhaust system and catalytic system are very hot whilst the engine is running or immediately after the engine is turned off. Keep away from the exhaust

system and catalytic, you may get burned.

Also, do not remove the heat sink around the exhaust system, do not seal the bottom of the vehicle or do not coat the vehicle for corrosion control. It may present a fire risk under certain conditions.

Your vehicle is equipped with a catalytic converter emission control device.

Therefore, the following precautions must be observed:

- Make sure to refuel your vehicle according to the "Fuel requirements" suggested in chapter 1.
- Do not operate the vehicle when there are signs of engine malfunction, such as misfire or a noticeable loss of performance.
- Do not misuse or abuse the engine. Examples of misuse are coasting with the ignition off and descending steep grades in gear with the ignition off.
- Do not operate the engine at high idle speed for extended periods (5 minutes or more).
- Do not modify or tamper with any part of the engine or emission control system. All inspections and adjustments must be made by a professional workshop. Kia recommends to visit an authorised Kia dealer/service centre.

- Avoid driving with an extremely low fuel level. Running out of fuel could cause the engine to misfire, damaging the catalytic converter.

Failure to observe these precautions could result in damage to the catalytic converter and to your vehicle. Additionally, such actions could void your warranties.

Petrol particulate filter

The Petrol Particulate Filter (PPF) is the system that removes the soot from the exhaust gas. Unlike a disposable air filter, the PPF system automatically burns (oxidises) and removes the accumulated soot whilst driving.





However, repeated short-distance driving or long-distance driving at a low speed can stop the accumulated soot from automatically being removed by the PPF system. If the accumulated soot reaches a certain amount, the PPF warning light () will illuminate. To re-operate the PPF system, the vehicle should be driven for more than 30 minutes at a speed of 80 km/h and faster. Ensure the following conditions are met: safe road conditions, transmission 3 or above, and engine speed of 1,500–4,000 rpm. Driving at 80 km/h or faster for recommended hours will get the PPF system back to work and stop the PPF warning light.

If the PPF warning light stays on or the warning message "check exhaust system" pops up even after

driving at recommended speed and for recommended hours, visit a professional workshop and have them check the PPF system. Constant driving with the PPF warning light on can damage the PPF system and undermine fuel economy.

Procedure for entering forced engine activation mode

If the engine needs to be kept running whilst the vehicle is stopped to inspect emission gas or perform vehicle maintenance, follow below procedure to enter forced engine activation mode.

1. Place the shift dial in P (Park) position with the vehicle stopped. Engage the parking brake. Then, follow the steps (1) to (5). Below steps from (1) to (5) must be completed within 60 seconds. If not, the process is reset and you must start again from step (1).
 - 1) Turn the ignition switch to the ON position. Vehicles equipped with the smart key, press the ENGINE START/STOP button twice without depressing the brake pedal.
 - 2) Place the shift dial in P (Park) position and depress the accelerator pedal twice.
 - 3) Place the shift dial in N (Neutral) position and depress the accelerator pedal twice.
 - 4) Place the shift dial in P (Park) position and depress the accelerator pedal twice.
 - 5) With the brake pedal depressed, start the engine, and maintain idling state. The engine remains in idle state and the forced engine activation mode is maintained even when the gear is shifted to a different position.
2.  indicator on the instrument cluster blinks when the vehicle is in forced engine activation mode. Check the  indicator blinking to ensure that the forced engine activation mode is correctly entered. The  indicator continues blinking until the forced engine activation mode is cancelled. When the mode is cancelled the  indicator will stop blinking.
3. To cancel the forced engine activation mode, turn the vehicle off.

Dimensions	9-2
Engine	9-2
Gross vehicle weight	9-3
Luggage volume	9-4
Air conditioning system	9-5
Bulb wattage	9-6
Tyres and wheels	9-7
Recommended lubricants and capacities	9-9
• Recommended SAE viscosity number	9-10
Vehicle Identification Number (VIN)	9-11
Vehicle certification label (if equipped)	9-12
Tyre specification and pressure label	9-13
Engine number	9-13
Air conditioner compressor label	9-14
Refrigerant label	9-14
Fuel label	9-15
Declaration of conformity	9-16
How to check the symbol on the charging label	9-17

Specifications & Consumer information

Dimensions

Item			5, 6, 7 seats [mm (in)]
Overall length			4,810 (189)
Overall width			1,900 (74.8)
Overall height	Without Roof rack		1,695 (66.7)
	With Roof rack		1,700 (66.9)
Tread	Front	235/65 R17	1,651 (65)
		235/55 R19	1,646 (64.8)
	Rear	235/65 R17	1,661 (65.3)
		235/55 R19	1,656 (65.2)
Wheelbase			2,815 (110.8)

Engine

For hybrid vehicle

Item	Smartstream G1.6 T-GDi HEV
Displacement [cc (cu in)]	1,598 (97.5)
Bore x Stroke [mm (in)]	75.6 x 89.0 (3 x 3.5)
Firing order	1-3-4-2
No. of cylinders	4 in-line

For plug-in hybrid vehicle

Item	Smartstream G1.6 T-GDi PHEV
Displacement [cc (cu in)]	1,598 (97.5)
Bore x Stroke [mm (in)]	75.6 x 89.0 (3 x 3.5)
Firing order	1-3-4-2
No. of cylinders	4 in-line

Gross vehicle weight

For hybrid vehicle

Item	FWD			AWD		
	5 seats	6 seats	7 seats	5 seats	6 seats	7 seats
Gross vehicle weight [kg (lbs.)]	2,510 (5,533)	2,530 (5,577)	2,580 (5,687)	2,530 (5,577)	2,580 (5,687)	2,610 (5,754)

For plug-in hybrid vehicle

Item	AWD			
	5 seats	6 seats	7 seats	7 seats (For Australia and New Zealand)
Gross vehicle weight [kg (lbs.)]	2,530 (5,577)	2,650 (5,842)	2,680 (5,908)	2,680 (5,908)

Luggage volume

For hybrid vehicle

Item		5 seats	6 seats	7 seats
Luggage volume (VDA) [L (cu ft)]	MIN.	697 (24.6)	608 (21.4)	608 (21.4)
	MAX.	902 (31.8)	813 (28.7)	813 (28.7)

For plug-in hybrid vehicle

Item		5 seats	6 seats	7 seats
Luggage volume (VDA) [L (cu ft)]	MIN.	693 (24.5)	604 (21.3)	604 (21.3)
	MAX.	898 (31.7)	809 (28.6)	809 (28.6)

- Min: Behind rear seat (seatback upright 23 degrees, cushion backwards) to upper edge of the seat back.
- Max: Behind rear seat (seatback upright 15 degrees, cushion forwards) to upper edge of the seat back.

Air conditioning system

Item		Weight of volume (g)	Classification	
Refrigerant	For hybrid vehicle	FRONT A/CON	650	R-134a*
		FRONT + REAR A/CON	850	
	For plug-in hybrid vehicle	FRONT A/CON	700	
		FRONT + REAR A/CON	1000	
	For hybrid vehicle	FRONT A/CON	575 ± 25	R-1234yf*
		FRONT + REAR A/CON	800 ± 25	
For plug-in hybrid vehicle	FRONT A/CON	650 ± 25		
	FRONT + REAR A/CON	900 ± 25		
Compressor lubricant	FRONT A/CON	150 ± 10	POE	
	FRONT + REAR A/CON	230 ± 10		

Please contact a professional workshop for more details.

Kia recommends to contact an authorised Kia dealer/service partner.

* : if equipped

Bulb wattage

Light bulb		Bulb type	Wattage (Watt)	
Front	Type A *	High beam	LED	LED
		Low beam	LED	LED
		Position and daytime running lamps	LED	LED
		Turn signal lamps	PY21W	21
		Front fog lamps*	LED	LED
	Type B *	High beam	LED	LED
		Low beam	LED	LED
		Auxiliary low beam	LED	LED
		Position and daytime running lamps	LED	LED
		Turn signal lamps	LED	LED
Front fog lamps*		LED	LED	
Rear	Type A *	Stop and tail lamps	21/5W	21/5
		Turn signal lamps	P21W	21
	Type B *	Stop and tail lamps	LED	LED
		Turn signal lamps	LED	LED
	Reversing lamp		P21W	21
	High mounted stop lamps		LED	LED
	License plate lamps		LED	LED
Rear fog lamp		LED	LED	
Interior	Map lamps (Bulb Type)*		WEDGE(W10W)	10
	Map lamps (LED Type)*		LED	LED
	Room lamps*		FESTOON	10
	Personal lamps*		LED	LED
	Vanity mirror lamps		FESTOON	5
	Glove box lamp		W5W	5
	Vanity mirror lamps*		BULB	5
	Luggage lamp (Bulb Type)*		FESTOON	8
Luggage lamp (LED Type)*		LED	LED	

* : if equipped

Tyres and wheels

For hybrid vehicle

Item	Tyre size	Wheel size	Load capacity		Speed capacity		Inflation pressure [bar (psi, kPa)]				Wheel lug nut torque [kgf·m (lbf·ft, N·m)]
			LJ ^{*1}	kg	SS ^{*2}	km/h	Normal load		Maximum load		
							Front	Rear	Front	Rear	
Full size tyre	235/65R17	7.0J X 17"	108	1000	V	240	2.4 (35, 240)	2.4 (35, 240)	2.55 (37, 255)	2.75 (40, 275)	11 ~ 13 (79 ~ 94, 107 ~ 127)
	235/55R19	7.5J X 19"	105	925	V	240					
Compact spare tyre (steel wheel) ^{*3}	T135/90D17	4B X 17"	104	900	M	130	4.2 (60, 420)	4.2 (60, 420)	4.2 (60, 420)	4.2 (60, 420)	

For plug-in hybrid vehicle

Item	Tyre size	Wheel size	Load capacity		Speed capacity		Inflation pressure [bar (psi, kPa)]				Wheel lug nut torque [kgf·m (lbf·ft, N·m)]
			LJ ^{*1}	kg	SS ^{*2}	km/h	Normal load		Maximum load		
							Front	Rear	Front	Rear	
Full size tyre	235/55R19	7.5J X 19"	105	925	V	240	2.5 (36, 250)	2.5 (36, 250)	2.55 (37, 255)	2.75 (40, 275)	11 ~ 13 (79 ~ 94, 107 ~ 127)
Compact spare tyre (steel wheel) ^{*3}	T135/90D17	4B X 17"	104	900	M	130	4.2 (60, 420)	4.2 (60, 420)	4.2 (60, 420)	4.2 (60, 420)	

*1. Load Index

*2. Speed Symbol

*3. If equipped

⚠ CAUTION

When replacing tyres, use the same size originally supplied with the vehicle. Using tyres of a different size can damage the related parts or make it work irregularly.

* NOTICE

- We recommend that when replacing tyres, use the same originally supplied with the vehicles.

If not, that affects driving performance.

- When driving in high altitude grades, it is natural for the atmospheric pressure to decrease.

Therefore, please check the tyre pressure and add more air when necessary.



Additionally required tyre air pressure per km above sea level: 1.5 psi/km

Recommended lubricants and capacities

To help achieve proper engine and powertrain performance and durability, use only lubricants of the proper quality.

The correct lubricants also help promote engine efficiency that results in improved fuel economy.

These lubricants and fluids are recommended for use in your vehicle.

Lubricant		Volume (L)	Classification	
Engine oil* ¹ (drain and refill) Recommends  	Except Middle East, Libya, Algeria, Iran, Morocco, Sudan, Tunisia, Egypt	4.8	SAE 0W-20, API SN PLUS/SP or ILSAC GF-6 ^{*2}	
	For Middle East, Libya, Algeria, Iran, Morocco, Sudan, Tunisia, Egypt		SAE 5W-30, ACEA A5/B5 ^{*3}	
Automatic transmission (AT) fluid ^{*4}		6	SK ATF SP4-M1, MICHANG ATF SP4-M1, S-OIL ATF SP4-M1, Kia Genuine ATF SP4-M1	
Coolant (Engine) ^{*5}		Coolant (Engine) ^{*5}	7.9	Ethylene glycol base coolant for aluminium radiator
Coolant (Inverter) ^{*5}	HEV	Coolant (Inverter) ^{*5}	1.9	Ethylene glycol base coolant for aluminum radiator
	PHEV		6.8	Contact an authorized Kia dealer/service partner
Brake fluid		As required (Reservoir tank volume: 441.4 ± 20.0 cc)	DOT 4	
Differential oil (Rear) (AWD)		0.53 ~ 0.63	HYPOID GEAR OIL API GL-5, SAE 75W/85 (Recommended: SK HCT-5 GEAR OIL 75W85 or equivalent)	
Transfer case oil (AWD)		0.62 ~ 0.68		
Fuel	HEV	67	Petrol	
	PHEV	47		

* 1. Refer to "Recommended SAE viscosity number" on page 9-10.

- * 2. Requires <API SN PLUS (or above) Full synthetic> grade engine oil. If a lower grade engine oil (mineral oil including Semi-synthetic) is used, then the engine oil and engine oil filter must be replaced as indicated severe maintenance condition.
- * 3. Requires <ACEA C2 Full synthetic> grade engine oil. If a lower grade engine oil (mineral oil including Semi-synthetic) is used, then the engine oil and engine oil filter must be replaced as indicated severe maintenance condition.
- * 4. If the genuine oil that is developed for best performance is not used, it may cause the problems of transmission performance.
- * 5. Different type of coolant or water may damage the electrical component.

Recommended SAE viscosity number

Temperature Range for SAE Viscosity Numbers										
Temperature	°C	-30	-20	-10	0	10	20	30	40	50
	°F	-10	0	20	40	60	80	100	120	
Smartstream G1.6 T-GDi HEV/PHEV	Except Middle East, Libya, Algeria, Iran, Morocco, Sudan, Tunisia, Egypt	0W-20								
	For Middle East, Libya, Algeria, Iran, Morocco, Sudan, Tunisia, Egypt	5W-30								



An engine oil displaying this API Certification Mark conforms to the international Lubricant Specification Advisory Committee (ILSAC). It is recommended to only use engine oils that uphold this API Certification Mark.

⚠ CAUTION

Always be sure to clean the area around any filler plug, drain plug, or dipstick before checking or draining any lubricant. This is especially important in dusty or sandy areas and when the vehicle is used on unpaved roads. Cleaning the plug and dipstick areas will prevent dirt and grit from entering the engine and other mechanisms that could be damaged.

Engine oil viscosity (thickness) has an effect on fuel economy and cold weather operating (engine start and engine oil flowability). Lower viscosity engine oils can provide better fuel economy and cold weather performance, however, higher viscosity engine oils are required for satisfactory lubrication in hot weather.

Using oils of any viscosity other than those recommended could result in engine damage.

When choosing an oil, consider the range of temperature your vehicle will be operated in before the next oil change. Proceed to select the recommended oil viscosity from the chart.

Vehicle Identification Number (VIN)

The Vehicle Identification Number (VIN) is the number used in registering your vehicle and in all legal matters pertaining to its ownership, etc.

The number is punched on the floor under the front passenger's seat. To check the number, open the cover.

For hybrid vehicle

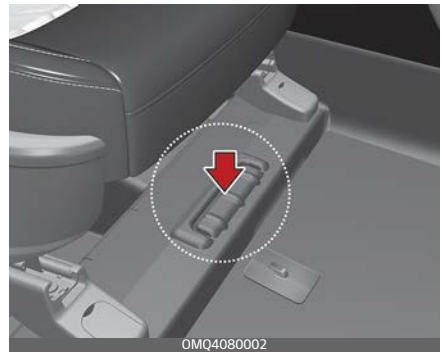

For plug-in hybrid vehicle



VIN label (if equipped)

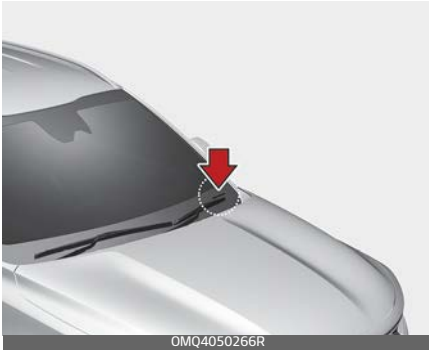

The VIN is also on a plate attached to the top of the dashboard. The number on the plate can easily be seen through the windscreen from outside.

Vehicle certification label (if equipped)

The vehicle certification label attached on the driver's (or front passenger's) side centre pillar gives the vehicle identification number (VIN).



Tyre specification and pressure label

The tyres supplied on your new vehicle are chosen to provide the best performance for normal driving.

The tyre label located on the driver's side centre pillar gives the tyre pressures recommended for your vehicle.

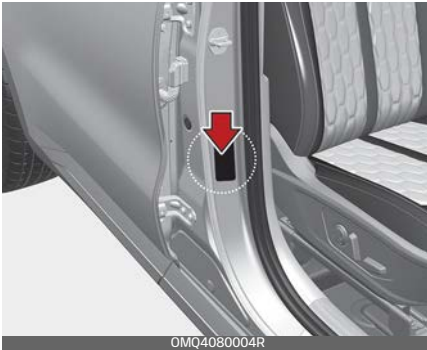

Engine number

The engine number is stamped on the engine block as shown in the drawing.

Smartstream G1.6 T-GDi HEV/PHEV

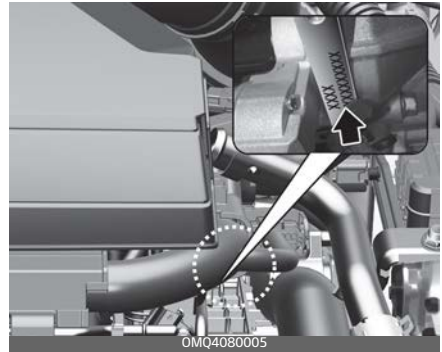

Air conditioner compressor label

A compressor label informs you the type of compressor your vehicle is equipped with such as model, supplier part number, production number, refrigerant (1) and refrigerant oil (2).



Refrigerant label

The refrigerant label is located under the bonnet.



Fuel label (if equipped)

The fuel label is attached on the fuel filler door.

Hybrid vehicle

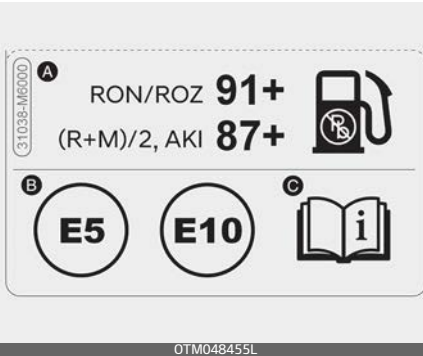

- A. Octane rating of unleaded petrol
 1. RON/ROZ: Research Octane Number
 2. (R+M)/2, AKI: Anti Knock Index
- B. Identifiers for Petrol-type fuels
 - * This symbol means usable fuel.
 - Do not use any other fuel.
- C. For further details, refer to the "Fuel requirements" on page 2-2.

Plug-in hybrid vehicle

For Europe



Except Europe



- A. Octane rating of unleaded petrol
 1. RON/ROZ: Research Octane Number
 2. (R+M)/2, AKI: Anti Knock Index
- B. Identifiers for Petrol-type fuels
 - * This symbol means usable fuel.
 - Do not use any other fuel.
- C. For further details, refer to the "Fuel requirements" on page 2-2.
- D. Add fuel into the fuel tank within 20 minutes.

Declaration of conformity







The radio frequency components of the vehicle comply with requirements and other relevant provisions of Directive 1995/5/EC.

Further information including the manufacturer's declaration of conformity is available on Kia web site as follows;

<http://www.kia-hotline.com>

How to check the symbol on the charging label (if equipped)

Vehicle charging INLET	Charging connector OUTLET
 <p>OMQ4PH010018L</p>	<p>Type A</p>  <p>OMQ4PH090001L</p>
 <p>OMQ4PH090003L</p>	<p>Type B</p>  <p>OMQ4PH091004L</p>  <p><Symbol location and application example></p>

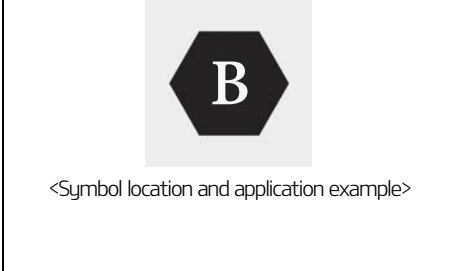

Precautions for charging AC and Trickle charger (Portable charging cable) (AC charging)

1. After opening the charging door, check the charging symbol at the bottom of the warning label.
2. Check the charging connector symbol of the AC and Trickle charger cable.
3. After checking the alphabet letter of the charging symbol, proceed the charging step.
 - * Refer to "Electric charging label symbol table" on page 9-20.
4. Risk of failure, fire, injury, etc. expected when using the charging connector with unmatched symbol.

Electric charging label



The electric charging label is attached on the charging door.

1 ~ 3: Warning for high voltage

4: Identifier for charging door



5: For more details, refer to "How to check the symbol on the charging label (if equipped)" on page 9-17.

6: Charging voltage and current - (~) AC single phase.

7: Identifiers for charging type. For more details, refer to "Electric charging label symbol table" on page 9-20.

Electric charging label symbol table

AC and Trickle charger charging

Supply Type	Configuration	Type of Accessory	Voltage range	Identifier
AC	7P	Vehicle connector and vehicle inlet	≤ 480V RMS	
AC	5P	Vehicle connector and vehicle inlet	≤ 250 V RMS	

Abbreviation **A**

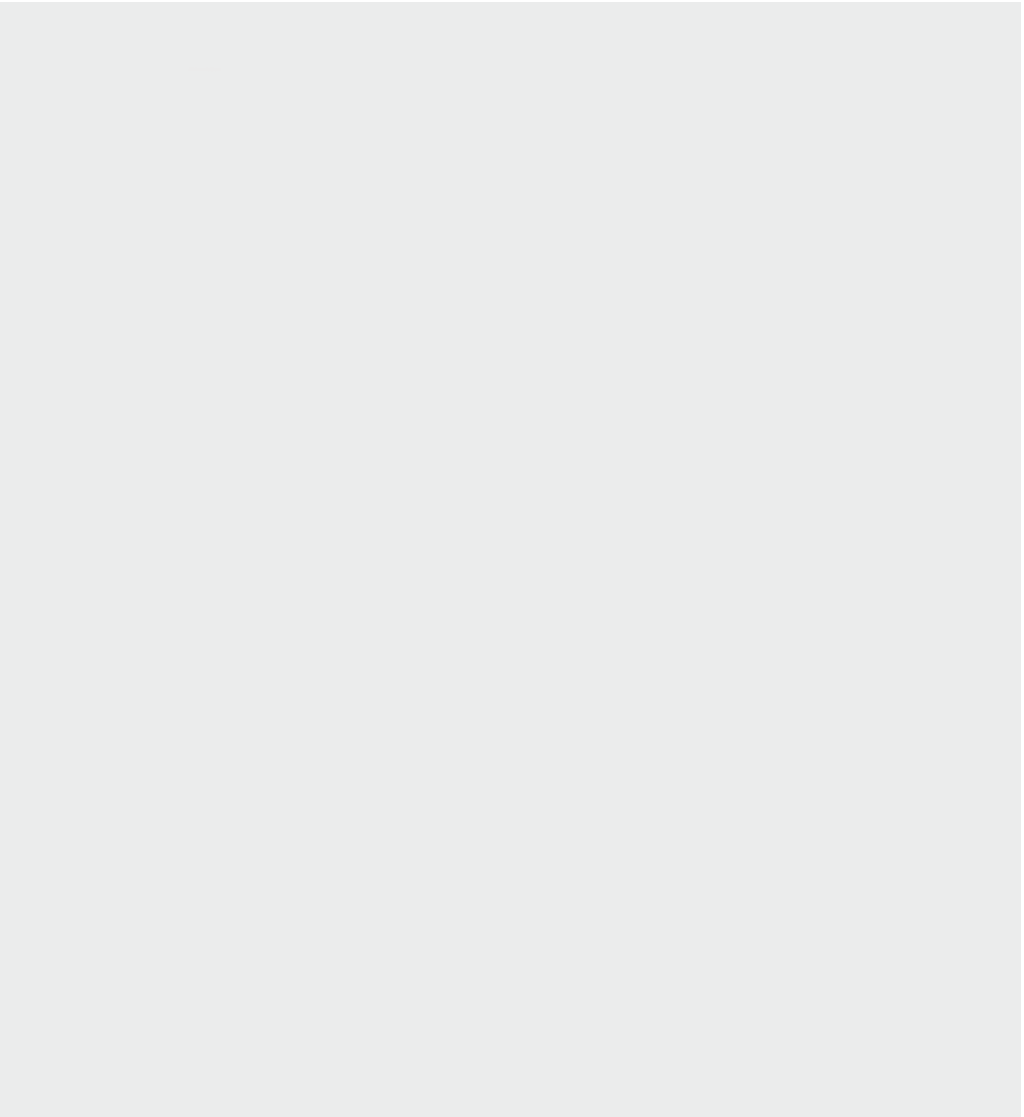

Abbreviation

ABS

Anti-lock Brake System

BAS

Brake Assistant System

BCA

Blind-Spot Collision-Avoidance Assist

BCW

Blind-Spot Collision Warning

BVM

Blind-Spot View Monitor

CO

Carbon Monoxide

CC

Cruise Control

CD

Charge Depleting

CRS

Child Restraint System

CS

Charge Sustaining

DAW

Driver Attention Warning

DBC

Downhill Brake Control

DRL

Daytime Running Light

EBD

Electronic Brake force Distribution

ECM

Electric Chromic Mirror

EPS

Electric Power Steering

ESC

Electronic Stability Control

ESS

Emergency Stop Signal

FCA

Forward Collision-Avoidance Assist

HAC

Hill-start Assist Control

HBA

High Beam Assist

HDA

Highway Driving Assist

HMSL

High Mounted Stop Lamp

HPCU

Hybrid Power Control Unit

HSG

Hybrid Starter Generator

HUD

Head-Up Display

ICCB

In-Cable Control Box

ISLA

Intelligent Speed Limit Assist

Abbreviation

LATCH

Lower Anchors and Tether for Children

LFA

Lane Following Assist

LKA

Lane Keeping Assist

MCB

Multi-Collision Brake

MDPS

Motor Driven Power Steering

MIL

Malfunction Indicator Lamp

MSLA

Manual Speed Limit Assist

NSCC

Navigation-based Smart Cruise Control

ODS

Occupant Detection System

PCA

Reverse Parking Collision-Avoidance Assist

PDW

Reverse Parking Distance Warning

RCCA

Rear Cross-Traffic Collision-Avoidance Assist

RCCW

Rear Cross-Traffic Collision Warning

RVM

Rear View Monitor

SBW

Shift-By-Wire

SCC

Smart Cruise Control

SEA

Safe Exit Assist

SEW

Safe Exit Warning

SRS

Supplemental Restraint System

SRSCM

SRS Control Module

SVM

Surround View Monitor

TBT

Turn By Turn

TCS

Traction Control System

TIN

Tyre Identification Number

TPMS

Tyre Pressure Monitoring System

VESS

Virtual Engine Sound System

VIN

Vehicle Identification Number

VSM

Vehicle Stability Management

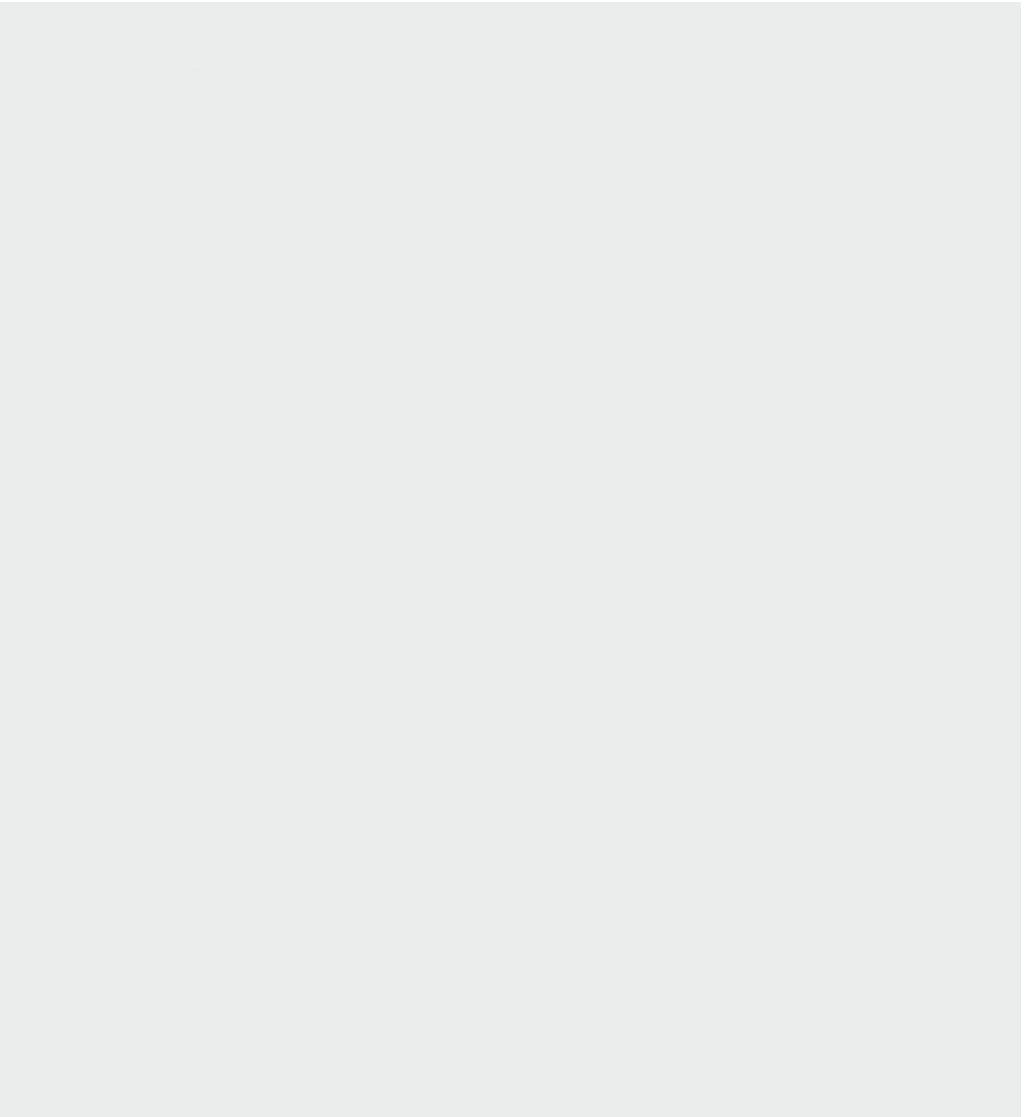

Index

A

AC charge	1-12
AC charging connector lock	1-8
air bag	
air bag collision sensors	4-65
curtain air bag	4-63
driver's and passenger's front air bag	4-56
how does the air bag system operate	4-48
inflation conditions	4-67
non-inflation conditions	4-68
passenger's front air bag on/off switch	4-58
side air bag	4-61
SRS care	4-70
SRS components and functions	4-53
to deactivate/reactivate the passenger's front air bag	4-59
warning and indicator	4-51
air bag - supplemental restraint system	4-47
air bag collision sensors	4-65
air cleaner filter	8-39
air ventilation seat	5-182
all wheel drive (AWD) system	6-26
ambient light	5-178
anti-lock brake system (ABS)	6-46
appearance care	8-97
exterior care	8-97
interior care	8-102
ashtray	5-179
audio system	5-196
radio	5-197
USB port	5-197
auto hold	6-43
automatic climate control system	5-162
air conditioning	5-171
controlling air intake	5-169

controlling fan speed	5-170
heating and air conditioning	
automatically	5-164
mode selection	5-167
temperature control	5-168
turning off the front air climate control	5-171
automatic transmission (dial SBW)	6-17
automatic transmission shift indicator	5-78
automatic transmission shift indicator in manual shift mode	5-79
AWD	
AWD mode	6-27
safe operation	6-29

B

battery	8-46
battery saver function	5-138
before driving	6-6
blind-spot collision-avoidance assist (BCA)	6-101
blind-spot view monitor (BVM)	6-140
bonnet	5-49
bonnet open warning	5-49
closing the bonnet	5-50
opening the bonnet	5-49
bonnet open warning	5-49
brake assistant system (BAS)	6-57
brake fluid	8-37
brake system	6-35
anti-lock brake system (ABS)	6-46
auto hold	6-43
brake assistant system (BAS)	6-57
downhill brake control (DBC)	6-51
electronic parking brake (EPB)	6-37
electronic stability control (ESC) system	6-48

emergency stop signal (ESS)	6-56	air conditioning	5-157
good braking practices	6-57	air conditioning refrigerant label	5-159
hill-start assist control (HAC)	6-53	checking the amount of air conditioner refrigerant and compressor lubricant	5-160
multi-collision brake (MCB)	6-53	climate control air filter	5-159
power brakes	6-35	heating	5-157
trailer stability assist (TSA)	6-56	system operation	5-157
vehicle stability management (VSM) system	6-54	ventilation	5-157
bulb replacement	8-81	closing the bonnet	5-50
bulb replacement precaution	8-77	coat hook	5-189

C

care of seat belts	4-35	components of the hybrid/plug-in hybrid vehicle	1-47
cargo security screen	5-191	hybrid vehicle components	1-51
centre console storage	5-177	if an accident occurs	1-55
changing plug-in hybrid mode (plug-in hybrid vehicle)	1-30	plug-in hybrid vehicle components	1-47
charging Information	1-4	service interlock connector	1-55
charging precautions	1-10	when the hybrid vehicle shuts off	1-56
charging status	1-6	cruise control (CC)	6-142
charging the plug-in hybrid vehicle	1-4	cup holder	5-179
AC charge	1-12	curtain air bag	4-63
AC charging connector lock	1-8		
charging Information	1-4		
charging precautions	1-10		
charging status	1-6		
charging time	1-4		
charging type	1-5		
how to disconnect charging connector in emergency	1-28		
scheduled charging	1-9		
trickle charger (portable charging cable)	1-14		
charging time	1-4		
charging type	1-5		
child restraint system (CRS)	4-36		
installing a CRS	4-39		
ISOFIX anchorage system	4-40		
types	4-38		
climate control air filter	8-41		
climate control system	5-157		

D

daytime running light (DRL)	5-138
defogging (windscreen)	5-172
defrosting (windscreen)	5-172
door lock	5-18
child-protector rear door lock	5-25
door lock/unlock features	5-23
from inside the vehicle	5-20
rear occupant alert (ROA)	
system	5-25
downhill brake control (DBC)	6-51
drive mode	6-59
drive mode integrated control system	6-59
drive mode	6-59
smart shift on trip computer	6-63

driver attention warning (DAW)	6-133	tyre pressure gauge	7-39
driver position memory system	5-27	emergency starting	
driver's 3-point system with emergency locking retractor	4-26	jump-starting	7-6
driver's and passenger's front air bag	4-56	push-starting	7-8
driving info display	5-96	emergency stop signal (ESS)	6-56
driving the hybrid/plug-in hybrid vehicle	1-29	emergency towing	7-36
energy flow	1-42	emission control system	8-105
hybrid system gauge	1-32	engine compartment	3-9, 8-5
LCD display messages	1-35	engine oil and filter	8-28
special features	1-31	engine overheats	7-8
starting the vehicle	1-29	engine start/stop button	6-12
warning and indicator lights	1-34	starting the engine	6-14
driving the plug-in hybrid vehicle		starting the engine with smart key	6-15
changing plug-in hybrid mode (plug-in hybrid vehicle)	1-30	exterior features	5-194
		roof rack	5-194
<hr/>			
E		F	
economical operation	6-219	flat tyre (with spare tyre)	7-16
electronic child safety lock system	5-23	flat tyre (with tyre mobility kit)	7-27
electronic parking brake (EPB)	6-37	floor mat anchor(s)	5-190
electronic stability control (ESC) system	6-48	forward collision-avoidance assist (FCA) - front view camera only	6-65
emergency	7-3	forward collision-avoidance assist (FCA) - sensor fusion type	6-78
emergency starting	7-6	forward/reverse parking distance warning (PDW)	5-132
flat tyre (with spare tyre)	7-16	front seat adjustment for manual seat	4-7
flat tyre (with tyre mobility kit)	7-27	front seat adjustment for power seat	4-8
hazard warning flasher	7-3	front seat headrest	4-11
if the engine will not start	7-5	fuel filler door	5-51
in case of an emergency whilst driving	7-4	fuel gauge	5-75
road warning	7-3	fuel requirements	2-2
towing	7-35	fuses	8-61
emergency commodity	7-39	driver's side fuse panel	8-66
first aid kit	7-39	engine compartment fuse panel	8-71
triangle reflector	7-39		

engine compartment fuse panel (battery terminal cover)	8-76
engine compartment fuse replacement	8-64
inner panel fuse replacement	8-63

G

gauges	5-73
fuel gauge	5-75
odometer	5-76
plug-in hybrid mode indicator	5-75
speedometer	5-73
glove box	5-177
good braking practices	6-57

H

headrest	
front seat headrest	4-11
rear seat headrest	4-21
head-up display (HUD)	5-117
heated steering wheel	5-63
HEV (hybrid electric vehicle) system	1-3
HEV/PHEV powertrain	2-6
highway driving assist (HDA)	6-173
hill-start assist control (HAC)	6-53
hybrid starter & generator (hsg) belt	8-36
hybrid vehicle components	1-51

I

immobiliser system	5-17
indicator lights	5-113
infotainment system	5-196
audio system	5-196
inside rear view mirror	5-65
installing a CRS	4-39
instrument cluster	5-71

automatic transmission shift indicator	5-78
automatic transmission shift indicator in manual shift mode	5-79
gauges	5-73
outside temperature gauge	5-78
plug-in hybrid mode indicator	5-75
shift indicator pop-up	5-79
transmission shift indicator	5-78

intelligent speed limit assist (ISLA)

interior features	5-178
air ventilation seat	5-182
ambient light	5-178
ashtray	5-179
cargo security screen	5-191
coat hook	5-189
cup holder	5-179
floor mat anchor(s)	5-190
power outlet	5-185
seat warmer	5-180
side curtain	5-189
sound mood lamp	5-178
sun visor	5-183
USB charger	5-183
wireless smart phone charging system	5-186
interior light	5-153
automatic turn off function	5-153
glove box lamp	5-156
luggage room lamp	5-155
map lamp	5-154
room lamp	5-155
vanity mirror lamp	5-156
ISOFIX anchorage system	4-40

J

jump-starting	7-6
----------------------	-----

K

key	5-7
battery replacement	5-7

immobiliser system	5-17
mechanical key	5-9, 5-12
key positions	6-8
starting the engine	6-10

L

lane following assist (LFA)	6-169
lane keeping assist (LKA)	6-94
LCD display	5-80
LCD display modes	5-81
LCD display messages	5-97
LCD displays	5-92
driving info display	5-96
LCD display messages	5-97
service mode	5-96
trip information (trip computer)	5-92
LCD windows	
distance to empty	5-77
light bulbs	8-77
bulb replacement	8-81
bulb replacement precaution	8-77
light bulb position (front)	8-79
light bulb position (rear)	8-80
light bulb position (side)	8-81
lighting	5-138
battery saver function	5-138
daytime running light (DRL)	5-138
front fog light	5-142
headlight escort function	5-138
headlight levelling device	5-146
high beam assist (HBA)	5-143
one-touch lane change	5-142
operating high beam	5-140
operating turn signals	5-141
rear fog light	5-143
lighting control	
auto light	5-140
head light (low beam)	5-140
position and tail lamp	5-139
luggage board	5-193
luggage net holder	5-190
Luggage side tray	5-194

luggage tray	5-193
---------------------	-------

M

maintenance	
appearance care	8-97
battery	8-46
brake fluid	8-37
climate control air filter	8-41
emission control system	8-105
engine oil and filter	8-28
fuses	8-61
lights bulbs	8-77
replacing rear wiper blades	8-44
tyres and wheels	8-50
washer fluid	8-38
wiper blades	8-42
maintenance services	8-6
owner maintenance precautions	8-6
owner's responsibility	8-6
manual speed limit assist (MSLA)	6-124
mechanical key	5-9, 5-12
mirrors	5-65
day/night rear view mirror	5-66
electric chromic mirror (ECM)	5-66
inside rear view mirror	5-65
outside rear view mirror	5-66
multi-collision brake (MCB)	6-53

N

navigation-based smart cruise control (NSCC)	6-163
-----------------------------------------------------	-------

O

odometer	5-76
one-touch lane change	5-142
opening the bonnet	5-49
outside rear view mirror	5-66
outside temperature gauge	5-78
owner maintenance	8-7

owner maintenance schedule 8-7

roof rack 5-194

P

Pan-European eCall system 7-40
panoramic sunroof 5-56
power sunshade 5-57
resetting the sunroof 5-59
PHEV (plug-in hybrid electric vehicle) system 1-2
plug-in hybrid mode indicator 5-75
plug-in hybrid vehicle components 1-47
power brakes 6-35
power outlet 5-185
power sunshade 5-57
power tailgate 5-32
power window lock button 5-46
pre-tensioner seat belt 4-30
push-starting 7-8

R

rear cross-traffic collision-avoidance assist (RCCA) system 6-180
rear occupant alert (ROA) system 5-25
rear seat adjustment 4-15
rear seat headrest 4-21
rear view monitor (RVM) 5-119
record your key number 5-7
remote key 5-8
remote smart parking assist (RSPA) 6-198
removable towing hook 7-36
reverse parking collision-avoidance assist (PCA) 6-191
reverse parking distance warning (PDW) 5-128
risk of burns when parking or stopping vehicle 2-5

S

safe exit assist (SEA) 6-118
safe exit warning (SEW) 6-114
scheduled charging 1-9
scheduled maintenance items 8-25
air cleaner filter 8-26
air conditioning refrigerant 8-27
automatic transmission fluid 8-26
brake discs, pads, calipers and rotors 8-27
brake fluid 8-27
brake hoses and lines 8-27
coolant 8-26
cooling system 8-26
drive shafts and boots 8-27
fluid levels 8-28
fuel lines, fuel hoses and connections 8-25
propeller shaft 8-28
spark plugs 8-26
steering gear box, linkage & boots/lower arm ball joint 8-27
suspension mounting bolts 8-27
vacuum crankcase ventilation hoses 8-25
vapour hose and fuel filler cap 8-25
scheduled maintenance service 8-9
scheduled maintenance service precaution 8-9
seat 4-3
feature of seat leather 4-6
front seat adjustment for manual seat 4-7
front seat adjustment for power seat 4-8
rear seat adjustment 4-15
seat belt 4-23
care of seat belts 4-35

driver's 3-point system with emergency locking retractor precautions	4-26	starting the engine with smart key	6-15
pre-tensioner seat belt warning	4-33	steering wheel	5-61
seat leather	4-30	electric power steering (EPS)	5-61
seat warmer	4-24	horn	5-65
seatback pocket	4-6	tilt & telescopic steering wheel	5-62
service interlock connector	5-180	storage compartment	5-176
service mode	4-14	centre console storage	5-177
shift indicator pop-up	1-55	glove box	5-177
side air bag	5-96	luggage board	5-193
side curtain	5-79	luggage net holder	5-190
small pocket	4-61	luggage side tray	5-194
smart cruise control (SCC)	5-189	luggage tray	5-193
smart key	4-14	sun visor	5-183
precautions	6-146	surround view monitor (SVM)	5-124
smart tailgate with auto open	5-12		
sound mood lamp	5-39		
special driving conditions	5-178		
specifications	6-220		
air conditioner compressor label	9-2	T	
air conditioning system	9-14	tailgate	5-29
bulb wattage	9-5	emergency tailgate safety release	5-31
declaration of conformity	9-6	power tailgate	5-32
dimensions	9-16	smart tailgate with auto open	5-39
engine	9-2	theft-alarm system	5-13
engine number	9-13	towing	7-35
fuel label	9-15	emergency towing	7-36
gross vehicle weight	9-3	emergency towing precautions	7-38
lubricants and capacities	9-9	removable towing hook	7-36
luggage volume	9-4	towing service	7-35
refrigerant label	9-14	towing service	7-35
tyre specification and pressure label	9-13	trailer stability assist (TSA)	6-56
tyres and wheels	9-7	trailer towing (for europe)	
vehicle certification label	9-12	driving with a trailer	6-233
vehicle identification number (VIN)	9-11	hitches	6-231
speedometer	5-73	maintenance	6-236
starting the engine	6-14	safety chains	6-232
		trailer brakes	6-232
		transmission shift indicator	5-78
		trickle charger (portable charging cable)	1-14
		trip information (Trip computer)	
		distance to empty	5-77

energy flow	5-95
range	5-95
trip information (trip computer)	
accumulated driving information	
mode	5-94
digital speedometer	5-95
drive info display	5-94
fuel economy	5-93
trip modes	5-93
tyre pressure monitoring system (TPMS)	7-10
tyres and wheels	8-50
checking tyre inflation pressure	8-51
low aspect ratio tyre	8-59
recommended cold tyre inflation pressures	8-50
tyre care	8-50
tyre maintenance	8-56
tyre replacement	8-54
tyre rotation	8-52
tyre sidewall labeling	8-56
tyre traction	8-55
wheel alignment and tyre balance	8-53
wheel replacement	8-55

U

USB charger	5-183
--------------------	-------

V

vehicle break-in process	2-5
vehicle handling instructions	2-6
vehicle identification number (VIN)	9-11
vehicle modifications	2-4
vehicle stability management (VSM) system	6-54
vehicle weight	6-241

W

warning and indicator lights	5-105
indicator lights	5-113
warning lights	5-105
warning lights	5-105
washer fluid	8-38
welcome system	5-152
window opening and closing	5-45
windows	5-43
power window lock button	5-46
window opening and closing	5-45
windscreen defrosting and defogging	5-172
defogging logic	5-175
defroster	5-174
winter driving	6-225
wiper blades	8-42
wipers and washers	5-147
operating rear window wiper and washer switch	5-151
wireless smart phone charging system	5-186

