

FOREWORD

Dear Customer,

Thank you for selecting your new Kia vehicle.

As a global car manufacturer focused on building high-quality vehicles with exceptional value, Kia is dedicated to providing you with a customer service experience that exceeds your expectations.

This Owner's Manual will acquaint you with the operation of features and equipment that are either standard or optional on this vehicle, along with the maintenance needs of this vehicle. Therefore, you may find certain descriptions and illustrations not applicable to your vehicle. You are advised to read this publication carefully and follow the instructions and recommendations. Please always keep this manual in the vehicle for your and any subsequent owner's reference.

If you need technical assistance, visit an authorized Kia dealership where factory trained technicians, recommended special tools, and genuine Kia replacement parts can be provided.

All information contained in this Owner's Manual was accurate at the time of publication. However, as Kia continues to make improvements to its products, the company reserves the right to make changes to this manual or any of its vehicles at any time without notice and without incurring any obligations.

Please drive safely, and enjoy your Kia vehicle!

© 2022 Kia Corporation

All rights reserved. May not be reproduced or translated in whole or in part without the written consent of Kia Corporation.

Printed in Korea

How to use this manual

We want to help you get the greatest possible driving pleasure from your vehicle. Your Owner's Manual can assist you in many ways.

We strongly recommend that you read the entire manual. In order to minimize the chance of death or injury, you must read the WARNING and CAUTION sections in the manual.

Illustrations complement the words in this manual to best explain how to enjoy your vehicle. By reading your manual, you learn about features, important safety information, and driving tips under various road conditions.

The general layout of the manual is provided in the Table of Contents. Use the index when looking for a specific area or subject, it has an alphabetical listing of all information in your manual.

Chapters: This manual has nine chapters plus an index. Each chapter begins with a brief list of contents so you can tell at a glance if that chapter has the information you want.

You will find various WARNINGS, CAUTIONS, and NOTICES in this manual. These WARNINGS were prepared to enhance your personal safety. You should carefully read and follow ALL procedures and recommendations provided in these WARNINGS, CAUTIONS and NOTICES.

WARNING

A WARNING indicates a situation in which harm, serious bodily injury or death could result if the warning is ignored.

CAUTION

A CAUTION indicates a situation in which damage to your vehicle could result if the caution is ignored.

NOTICE

A NOTICE indicates interesting or helpful information is being provided.

Table of Contents

Electric vehicle guide	①
Introduction	②
Your vehicle at a glance	③
Safety features of your vehicle	④
Features of your vehicle	⑤
Driving your vehicle	⑥
What to do in an emergency	⑦
Maintenance	⑧
Specifications & Consumer information	⑨
Abbreviation	Ⓐ
Index	Ⓛ

Review of electric vehicle	1-3
Main components of electric vehicle	1-4
• High Voltage (HV) battery (lithium-ion polymer)	1-4
• High voltage battery warmer system	1-5
EV menu	1-6
• EV mode screen.....	1-7
• Next departure.....	1-8
• Charging and climate.....	1-8
• Nearby stations.....	1-9
• EV settings	1-10
Charge types for electric vehicle	1-13
• Charging information.....	1-13
• Charging time information	1-13
• Charging types.....	1-14
Charge indicator lamp for electric vehicle	1-15
• Charging status.....	1-15
Charging connector lock	1-15
• Locking charging cable	1-15
• When the charging connector is locked	1-15
Scheduled charging	1-16
Charging electric vehicle	1-17
• Charging door	1-17
• Precautions for charging electric vehicle	1-18
• AC charge.....	1-20
• DC charge.....	1-22
• Portable charge	1-23
Charging the electric vehicle (Abrupt stop)	1-35
Driving electric vehicle	1-35
• Starting the vehicle.....	1-35
• Stopping the vehicle	1-36

1 Electric vehicle guide

- Virtual Engine Sound System (VESS).....1-36
- Distance to empty.....1-36
- ECO driving 1-38
- Environment contribution 1-38
- Energy consumption 1-38
- Power/Charge gauge.....1-39
- State of charge (SOC) gauge for high voltage battery1-39
- Warning and indicator lights (related to electric vehicle) 1-40
- LCD display messages.....1-41
- 12V Aux. Battery Saver+..... 1-46

Safety precautions for electric vehicle 1-47

Electric vehicle guide

Review of electric vehicle

An electric vehicle is driven using a battery and an electric motor. While general vehicles use an internal combustion engine and gasoline as fuel, electric vehicles use electrical energy that is charged & stored inside the high voltage battery.

As a result, electric vehicles are eco-friendly in that they do not require fuel and do not emit exhaust gases.

Characteristics of electric vehicles

It is driven using the electrical energy that is charged & stored inside the high voltage battery. This method prevents air pollution since fuel, like gasoline, is not required, negating the emission of exhaust gases.

A high performance electric motor is used in the vehicle as well. Compared to standard, internal combustion engine vehicles, engine noise and vibrations are much more minimal when driving.

When decelerating or driving downhill, regenerative braking is utilized to charge the high voltage battery. This minimizes energy loss and increases the distance to empty.

When the battery charge is not sufficient, AC charge (L2-Normal), DC charge and Trickle charge (L1-Trickle) are available. (Refer to "Charge types for electric vehicle" on page 1-13.)

Battery information

The vehicle is composed of a high voltage battery that drives the motor, air conditioner, and charges an auxiliary battery (12 V) that drives all other 12 V systems.

The auxiliary battery is automatically charged when the vehicle is in  mode or the high voltage battery is being charged.

* NOTICE

What does regenerative braking do?

It uses the electric motor when decelerating and recaptures & transforms kinetic to electrical energy in order to charge the high voltage battery.

Main components of electric vehicle

- **On-Board Charger (OBC):** Transforms (inverts) AC power to DC power, to charge the high voltage battery
- **Inverter:** Transforms direct current into alternating current to supply power to the motor, and transforms alternating current into direct current to charge the high voltage battery.
- **LDC:** Transforms (converts) power from the high voltage battery to low voltage (12 V) to supply power to the vehicle (DC-DC).
- **VCU:** Functions as a supervisory controller of electric vehicle
- **Motor:** Uses electrical energy stored inside the high voltage battery to drive the vehicle (functions like an engine in a standard vehicle).
- **Reduction gear:** Delivers rotational force of the motor to the tires at appropriate speeds and torque.
- **High voltage battery (lithium-ion polymer):** Stores and supplies power necessary for the electric vehicle to operate (12 V auxiliary battery provides power to the vehicle features such as lights and wipers).

* OBC: On-Board Charger

* LDC: Low Voltage DC-DC Converter

* VCU: Vehicle Control Unit

High Voltage (HV) battery (lithium-ion polymer)

The HV battery powers the vehicle and peripheral devices.

The charge amount of the HV battery may gradually decrease when the vehicle is not driven or charged.

The battery capacity of the HV battery may decrease over time when the vehicle is stored in high temperatures and temporarily in low temperatures.

Distance to empty may vary depending on the driving conditions (cargo, rain, snow, wind, road surfaces), even if the charge amount is the same. The HV battery may expend more energy when driving a fast pace or uphill. These actions may reduce the distance to empty.

The high voltage battery is used when using the air conditioner/heater and/or use the pre-conditioning prior to departures. This may reduce the distance to empty. Make sure to set moderate temperatures when using the air conditioner/heater.

Natural degradation may occur with the high voltage battery depending on the number of years the vehicle was used and/or the number of charging cycles. This will reduce the distance to empty over time.

When the charge capacity and distance to empty keep falling, contact an authorized Kia dealer/service partner for inspection and maintenance.

If the vehicle will not be in use for an extended period of time, charge the high voltage battery once every three months to prevent it from discharging. Also, if the charge amount is not enough, immediately charge to full and store the vehicle.

AC (L2-Normal) charging is recommended to keep the high voltage battery in optimal condition.

If the HV battery is only charged to 80%, and you minimize the number of DC fast charging, you can keep the HV battery performance in optimal condition. (vs charging the HV battery to 100% an/or charging every drive cycle.)

The value of the high voltage battery charge level may vary according to the charging conditions (state of charger, outside temperature, battery temperature, etc.). In order to fully charge the battery, the current of the high voltage battery will be gradually decreased, so that the longevity and safety of the battery can be secured.

High voltage battery warmer system

The high voltage battery warmer system prevents reduction of battery output when battery temperature is low. If the charging connector is connected, the warmer system automatically operates according to the battery temperature.

Charging time may shorten compare to vehicles without the high voltage battery warmer system. But, electricity charge may increase because of high voltage battery warmer system operation.

⚠ WARNING

- Do not remove or disassemble high voltage components and high voltage battery connectors and/or wiring (orange cabling). Also, be careful not to damage high voltage components and the high voltage battery. It may cause serious injury and significantly impact the performance and durability of the vehicle.
- When inspection and maintenance is required for high voltage components and the high voltage battery, have the vehicle inspected by an authorized Kia dealer/service partner.

⚠ CAUTION

- Make sure to use a designated charger when charging the HV battery. Using different types of chargers may have a serious impact on vehicle durability.
- Make sure that the HV battery charge gauge does not reach E (Empty). If the vehicle is kept at E (Empty) for a long period, it may damage the high voltage battery and the high voltage battery may have to be replaced, depending on the level of degradation.
- If the vehicle is in a collision, contact an authorized Kia dealer/service partner to inspect whether the high voltage battery is still connected.
- If the vehicle is kept with insufficient charge for a long period, it may damage the high voltage battery and the high voltage battery may have to be replaced depending on the level of degradation.

- If the vehicle is in a collision, we recommend to visit an authorized Kia dealer/service partner to inspect whether the high voltage battery is still connected.

*** NOTICE**

The high voltage battery warmer system operates when the charging connector is connected to the vehicle.

However, the high voltage warmer system may not operate when battery temperature drops below -35 °C (-95 °F).

EV menu (if equipped)

If you select the **EV** menu at the multi-media system home screen or press the **EV** button on the left side of the air intake control button, you can enter **EV** menu.



* The image of **EV** menu screen in this manual may differ from the actual screen depending on the vehicle specification and the version of the multi-media system software.

*** NOTICE**

The infotainment system may change after software updates. For more information, refer to the manual provided in the infotainment system and the quick reference guide.

EV mode screen

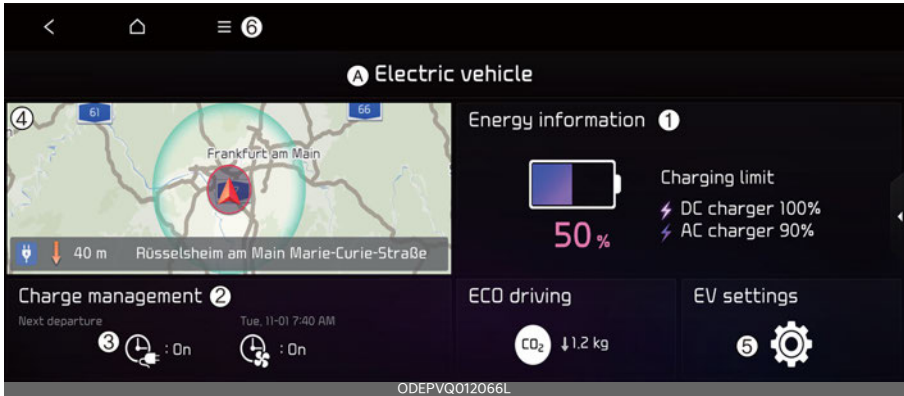

A. Electric Vehicle

- 1 Energy Information
- 2 Next Departure
- 3 Charging and Climate
- 4 Nearby Stations
- 5 EV Settings
- 6 Menu

Next departure

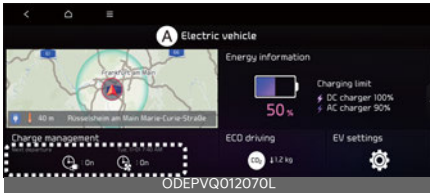

A: Electric vehicle

Select **EV** → **Next departure** on the screen. You can set the date and time of when to charge the battery, climate control temperature, and other various functions.

Departure time

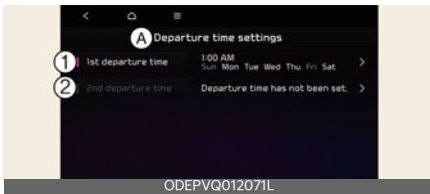

A: Departure time settings

- 1 1st departure time
- 2 2nd departure time

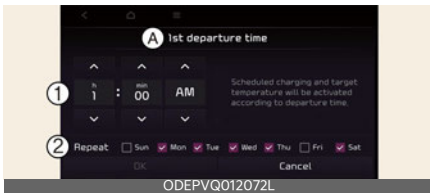

A: 1st departure time

- 1 Departure Time
 - 2 Departure Day
1. Set anticipated departure time for scheduled charging and target temperature.
 2. Select the day of the week to activate scheduled charging and target temperature for departure time.

* NOTICE

The infotainment system may change after software updates. For more information, refer to the manual provided in the infotainment system and the quick reference guide.

Charging and climate

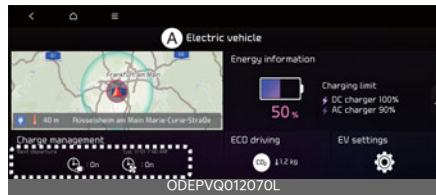

A: Electric Vehicle

Select **EV** → **Scheduled charging and target temperature** on the screen.

* NOTICE

Vehicle must be connected with the charging connector at the time pre-scheduled time for the scheduled charging.

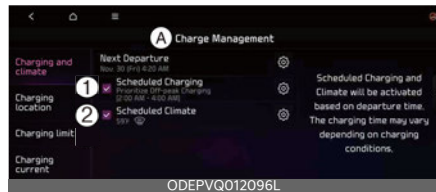

A: Charge Management

- 1 Scheduled Charging
- 2 Scheduled Climate

You can set the date and time of when to charge the battery and the climate control temperature. Also, you may select the time to start charging using the Off-peak time settings.

Off-peak time settings



A: Off-peak time settings

1 Set start time

2 Set end time

3 Charging options

- If selected, starts charging only on the designated off-peak time. If deselected, starts charging only on the scheduled time.
- Set the most inexpensive time to complete charging.
 - Off-peak tariffs prioritised:** If selected, starts charging at off-peak time (may keep on charging pass off-peak time to charge 100%).
 - Off-peak tariffs only:** If selected, charges only within off-peak time (may not charge 100%).

Target temperature settings

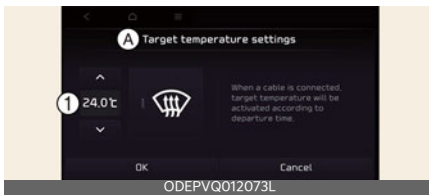

A: Target temperature settings

1 Target temperature

If the target temperature (1) is set with the cable connected, the cabin temperature will be adjusted to the target temperature at departure time. In cold weather, pre-scheduled heating helps

enhance electric vehicle performance by heating the vehicle in advance.

* NOTICE

The infotainment system may change after software updates. For more information, refer to the manual provided in the infotainment system and the quick reference guide.

Nearby stations

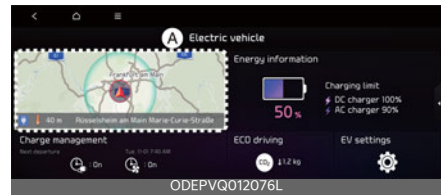

A: Electric Vehicle

Select the map from the infotainment system screen. Stations around the current location are searched.

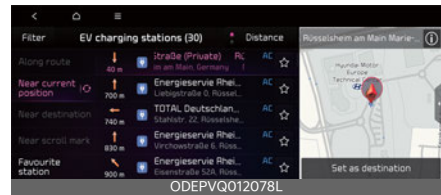

Select the icon on the screen.

Around the course, around the current site, around the selected destination or charging stations of interest will be searched. If you choose the charging station, the detailed information will be provided.

*** NOTICE**

The infotainment system may change after software updates. For more information, refer to the manual provided in the infotainment system and the quick reference guide.

EV settings

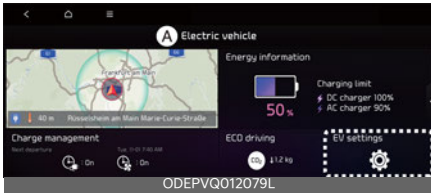

A: Electric vehicle

Select the icon on the screen. You can set the charging limit, charging current, battery conditioning mode and utility mode functions.

Charging limit

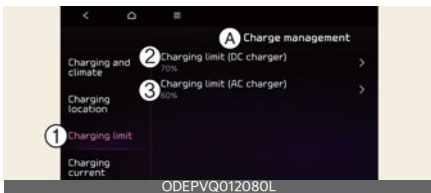

A: Charge management

- 1 Charging limit**
- 2 DC charger**
- 3 AC charger**

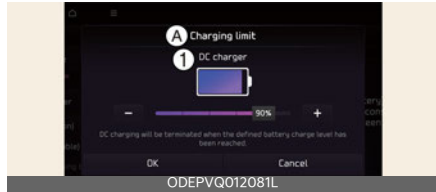

A: Charging limit

1 DC charger

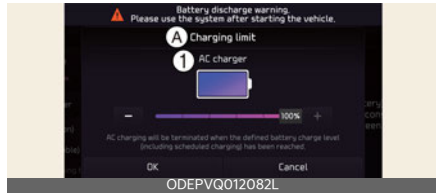

A: Charging limit

1 AC charger

- The target battery charge level can be selected when charged with AC charger or DC charger.
- The charging level can be changed by 10%.
- If the target battery charge level is lower than the high voltage battery charge level, the battery will not be charged.

*** NOTICE**

The infotainment system may change after software updates. For more information, refer to the manual provided in the infotainment system and the quick reference guide.

Charging current

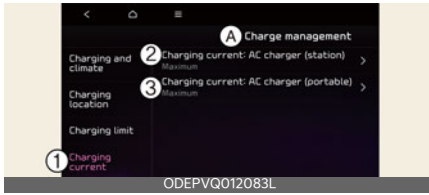

A: Charge management

1 Charging current

2 AC charger (station)

3 AC charger (portable)

- You can adjust the charging current for an AC charger. Select an appropriate charging current.
- If the charging process does not start or abruptly stops in the middle, reselect another proper current and re-try charging the vehicle.
- Charging time varies depending on which charging current is selected.

* NOTICE

The infotainment system may change after software updates. For more information, refer to the manual provided in the infotainment system and the quick reference guide.

Winter mode

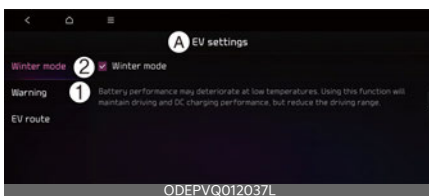

A: EV Settings

1 Winter mode

2 Winter mode

You can select or deselect **Winter mode**.

The Winter mode is efficient during the winter time when the high voltage battery temperature is low.

This mode is recommended to improve driving and DC charging performances during winter by raising the battery temperature to an adequate level.

However, the driving distance may be reduced as the energy is required to increase battery temperature.

Also, if the battery temperature is low during driving or when scheduled air conditioner/heater is activated, this mode is operated to improve driving performance.

However, the mode is not operated to ensure driving distance when the battery level is low.

* NOTICE

This mode is available for the vehicles equipped with the battery heater.

Utility mode

The high voltage battery is used instead of the 12V auxiliary battery for operating the convenient features of the vehicle. When driving is not necessary such as while camping or when stopping the vehicle for a long time, it is possible to use the electrical devices (audio, lights, air conditioner, heater, etc.) for long hours.

System setting and activation

System setting

The driver can activate the Utility mode function when the following conditions are satisfied.

- The vehicle is in (🚗) mode and the gear is shifted to P (Park).
- The EPB (Electronic Parking Brake) is not a malfunction.
- **Utility mode** is selected on the instrument cluster screen.

System activation

When the system is activated:

- The (🚗) indicator will turn off, and the **UTIL** indicator will appear on the cluster and the EPB is applied.
- All electric devices are usable but the vehicle cannot be driven.
- The EPB can be canceled by pressing the EPB switch.

Gear cannot be shifted out of P (Park). If a shift attempt is made, a warning message will be displayed on the infotainment system screen.

System deactivation

The Utility mode can be deactivated by pressing the START/STOP button to the OFF position. The function cannot be deactivated from the **EV settings**.

Range warning

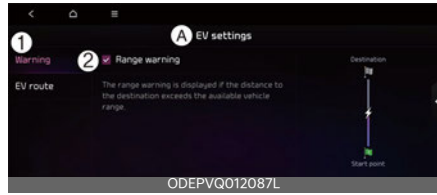

A: **EV settings**

1 Warning

2 Range warning

If the destination set in the navigation cannot be reached with the remaining battery, a warning message is displayed.

EV route



A: **EV settings**

1 EV route

2 Show EV route on the map

You can apply electric car-related functions for guiding the route. It allows you to check the distance that you can go with the current battery amount. Travelable and non-travelable sections on your way to the destination are displayed on the screen. The search station icon is also displayed so that you can find nearby stations immediately.

Charge types for electric vehicle

Charging information

- **AC Charge:** The electric vehicle is charged by plugging into a AC charger installed at your home or a public charging station. (For further details, refer to "AC charge" on page 1-20.)
- **DC Charge:** You can charge at high speeds at public charging stations. Refer to the respective company's manual that is provided for each DC charger type. Battery performance and durability can deteriorate if the DC charger is used constantly.

Use of DC charge should be minimized in order to help prolong high voltage battery life.

- **Portable Charge:** The Electric vehicle can be charged by using household electricity. The electrical outlet at your home must comply with regulations and can safely accommodate the Voltage/Current (Amps)/Power (Watts) ratings specified on the portable charge.

Charging time information







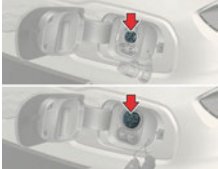
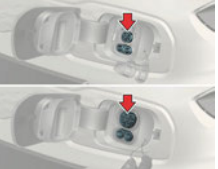
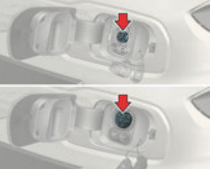

Charging type		Charging time
AC charge		Takes approx. 9 hours 20 minutes at room temperature when charged from 10% to 100%.
DC charge	100 kW charger	Takes about 47 minutes at room temperature when charged from 10% to 80%. Can be charged to 100%.
	50 kW charger	Takes about 64 minutes at room temperature when charged from 10% to 80%. Can be charged to 100%.
Portable charge		Takes approx. 29 hours at room temperature when charged from 10% to 100%.

* NOTICE

Depending on the condition and durability of the high voltage battery, charger specifications, and ambient temperature, the time required for charging the high voltage battery may vary.

Charging types

- Actual charger image and charging method may vary in accordance with the charger manufacturer.
- A maximum diagnosis time of 3 minutes may be added to check the battery condition during the battery charging process.

Category	AC Charge	DC Charge	Portable Charge
Charging Inlet (Vehicle)	 <p>ODEPVQ012001L_2</p>	 <p>ODEPVQ012002L_2</p>	 <p>ODEPVQ012001L_2</p>
Charging Connector	 <p>ODEPVQ012099L_2</p>	<p>Type A</p>  <p>OCVQ011006L</p> <p>Type B</p>  <p>OCVQ011061</p>	 <p>ODEPVQ012099L_2</p>
Charging Outlet	 <p>OCVQ011007L</p>	 <p>OCVQ011008L</p>	<p>Type A</p>  <p>OCVQ011009L</p> <p>Type B</p>  <p>ODEPVQ012093</p>
How to Charge	Use AC charger installed at home or public charging station	Use the DC charger at public charging station	Use household current

Charge indicator lamp for electric vehicle

Charging status

When charging the high voltage battery, the charge level can be checked from outside the vehicle.



Details	Operation of charging indicator lamp		
	(1)	(2)	(3)
Not charged	OFF	OFF	OFF
Charging (0~33%)	Blinking	OFF	OFF
Charging (34~66%)	ON	Blinking	OFF
Charging (67%~99%)	ON	ON	Blinking
Charging completed (100%) (Turns off in approximately 5 seconds)	ON	ON	ON
Error while charging	Blinking	Blinking	Blinking
Charging 12V auxiliary battery or reserved air conditioner is operating	OFF	OFF	Blinking
Reserved charging is operating or interruptions that temporarily prevent charging (e.g. power failure) (Turns off after approximately 3 minutes)	OFF	Blinking	OFF

- * When charging, the indicator lamp blinks according to each level of the battery.
- * When charging fails, the indicator lamp blinks in red.

Charging connector lock

Locking charging cable



You may select when the charging connector can be locked and unlocked in the charging inlet. Press the AUTO/ LOCK mode button (AUTO) to change between AUTO mode and LOCK mode.

When the charging connector is locked

Details	LOCK	AUTO
Before charging	O	X
While charging	O	O
Finished charging	O	X

LOCK mode (button indicator OFF)

The connector locks when the charging connector is plugged into the charging inlet. The connector is locked until all doors are unlocked by the driver. This mode can be used to prevent charging cable theft.

- If the charging connector is unlocked when all doors are unlocked, but the charging cable is not disconnected within approximately 15 seconds, the connector will be automatically locked again.
- If the charging connector is unlocked when all doors are unlocked, but all doors are locked again, immediately, the connector will be automatically locked again.

AUTO mode (button indicator ON)

The connector locks when the charging starts. The connector unlocks when charging is complete. This mode can be used when charging in a public charging station.

If the connector does not unlock automatically after the charging is completed in AUTO mode, the connector will unlock when all the doors are unlocked.

Scheduled charging

- You can set reserved charging using the infotainment system. Refer to the infotainment system for detailed information about setting reserved charging.
- Scheduled charging can only be done when using a AC charger or the portable charging cable (ICCB: In-Cable Control Box).
- When scheduled charging is set and the AC charger or the portable charging cable (ICCB: In-Cable Control Box) is connected for charging, the scheduled charge release button is illuminated (for approximately 3 minutes) to indicate that scheduled charging is set.



- When scheduled charging is set, charging is not initiated immediately when the AC charger or portable charging cable (ICCB: In-Cable Control Box) is connected.

- If charging is required immediately, turn off the scheduled charge using the infotainment system and Kia Connect application, or press the vehicle's scheduled charging deactivation button ().



- When the scheduled charge is set, the charge start time is calculated by itself. In some cases, charging may start immediately after connecting the charger.
- If you press the scheduled charging deactivation () button to immediately charge the battery, charging must be initiated approximately 3 minutes after the charging cable has been connected.

When you press the scheduled charging deactivation () button for immediate charging, the scheduled charge setting is not completely deactivated. If you need to completely deactivate the scheduled charge setting, use the infotainment system to finalize the deactivation.

Refer to "AC charge" on page 1-20 or "Portable charge" on page 1-23 for details about connecting the AC charger and the portable charger (ICCB: In-Cable Control Box).

Charging electric vehicle

Charging door

Opening the charging door



Operation

- Press the right center edge of the charging door.
- The charging door is not open when the vehicle is locked.

Closing the charging door

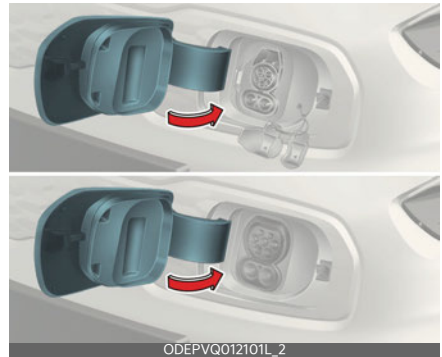

Operation

- Close the charging door by pressing rear center edge of the charging door.

Precautions for charging electric vehicle

AC charger



AC charging cable (Type A) (if equipped)



AC charging cable (Type B) (if equipped)



DC charger



* Actual charger image and charging method may vary in accordance with the charger manufacturer.

Unlock charging connector in emergency



If the charging cable does not detach due to battery discharge and failure of the electric wires, open the hood and slightly pull the emergency cable as shown above. The charging connector will then unlock.

WARNING

- Electromagnetic waves that are generated from the charger can seriously impact medical electric devices, such as an implantable cardiac pacemaker. When using electronic medical devices, such as an implantable cardiac pacemaker, make sure to ask the medical team and manufacturer whether charging your electric vehicle will impact the operation of the medical electric devices, such as an implantable cardiac pacemaker.
- Check to make sure there is no water or dust on the charging cable connector and plug before connecting to the charger and charging inlet. Connecting while there is water or dust on the charging cable connector and plug may cause a fire or electric shock.
- Be careful not to touch the charging connector, charging plug, and the charging inlet when connecting the charger connector cable to the charging outlet and the charging inlet on the vehicle.

- Comply with the following in order to prevent electrical shock when charging:
 - Use a waterproof charger.
 - Do not touch the charging connector and charging plug with your hands wet, or do not stand in water or snow while connecting the charging cable.
 - Be careful when there is lightning.
 - Be careful when the charging connector and plug are wet.
- Immediately stop charging when you discover abnormal symptoms (e.g., smell, smoke, etc.)
- Replace the charging cable if the cable coating is damaged to prevent electrical shock.
- When connecting or removing the charging cable, make sure to hold the charging connector handle.
- Only use the charging cable (if equipped) certified by Kia. If you use a separate extension cable such as a reel or use an uncertified cable, it may cause abnormalities of electrical outlets, leading to fire or explosion.
- If you pull the cable itself (without using the handle), the internal wires may be disconnected or get damaged. This may lead to electric shock or fire.
- Do not leave the vehicle with the charging door open. An open charging door may indicate that the vehicle door has been unlocked and may be subject to vehicle theft.

⚠ CAUTION

- Always keep the charging connector and charging plug in clean and dry condition. Be sure to keep the charging cable in a condition where there is no water or moisture.
- Make sure to use the designated charger for charging the electric vehicle. Using any other charger may cause failure.
- Before charging the battery, turn the vehicle [OFF].
- When the vehicle is switched [OFF] while charging, the cooling fan inside the motor compartment may automatically operate. Do not touch the cooling fan while charging.
- Be careful not to drop the charging connector. The charging connector can be damaged.
- Do NOT use a extension cord, when using the L1-Trickle charger, as this may overheat and/or cause damage.

*** NOTICE**

When charging or right after charging the high voltage battery, the cooling will be made using air conditioner system in order to control the high voltage battery temperature.

At this time, the noise might occur by the air conditioner compressor and cooling fan, but this is due to normal operation.

AC charge



* Actual charger image and charging method may vary in accordance with the charger manufacturer.

How to connect AC charger

1. Depress the brake pedal and apply the parking brake.
2. Turn OFF all switches, shift to P (Park), and turn OFF the vehicle. If charging is initiated without the gear in P (Park), the charging will start after the gear is automatically shifted to P (Park).
3. Open the charging door.



For more details, refer to "Charging door" on page 1-17.

4. Check if there is dust on the charging connector and charging inlet.
5. Hold the charging connector handle and connect it to the vehicle charging inlet. Push the connector all the way in. If the charging connector and charging terminal are not connected properly, this may cause a fire.

For more details, refer to "Charging status" on page 1-15.

6. Connect the charging plug to the electric outlet at a AC charging station to start charging.
7. Check if the charging indicator light (S) of the high voltage battery in the instrument cluster is turned ON. Charging is not active when the charging indicator light (S) is OFF. When the charging connector and charging plug are not connected properly, reconnect the charging cable to charge.



8. After charging has started, the estimated charging time is displayed on the instrument cluster for about 1 minute.

If you open the driver seat door while charging, the estimated charging time is also displayed on the instrument cluster for about 1 minute. When scheduled charging or scheduled air conditioner/heater is set, the estimated charging time is displayed as "-".



A: Remaining Time

Checking charging status

When charging the high voltage battery, the charge level can be checked from outside the vehicle.

For more details, refer to "Charge indicator lamp for electric vehicle" on page 1-15.

How to disconnect AC charger

1. When charging is complete, remove the charging plug from the electrical outlet of the AC charging station.



2. Hold the charging connector handle (1) and pull it out.

Type A



Type B



3. Make sure to completely close the charging door.
4. Close the protection caps of the charging connector and the charging plug to protect them from foreign substances.

5. If the personal charging connector is used, store the connector in the cable compartment.

* NOTICE

- If you cannot open the charging door due to freezing weather, tap lightly or remove any ice near the charging door. Do not try to forcibly open the charging door. If you open it by force, the charging door may be damaged.
- When the charging connector and the charging inlet are connected, you can choose the mode by pressing button. The charging connector will be locked at a different time depending on the selected mode.
 - LOCK Mode: When the charging connector is properly connected, the charging connector will be automatically locked.
 - AUTO Mode: When the charging connector is properly connected and charging is initiated, the charging connector will be locked.
- Even though charging is possible with the START/STOP button in the ON/START position, for your safety, start charging when the START/STOP button is in the OFF position and the vehicle shifted to P (Park). After charging has started, you can use electrical components such as the radio by pressing the START/STOP button to the ACC or ON position.
- During AC charging, the radio reception may be bad.
- During charging, the gear cannot be shifted from P (Park) to any other gear.

- Depending on the condition and durability of the high voltage battery, charger specifications, and ambient temperature, the time required for charging the battery may vary.

DC charge



You can charge at high speeds at public charging stations. Refer to the respective company's manual that is provided for each DC charger type.

Battery performance and durability can deteriorate if the DC charger is used constantly.

Use of DC charge should be minimized in order to help prolong high voltage battery life.

Actual charger image and charging method may vary in accordance with the charger manufacturer.

How to connect DC charger

1. Depress the brake pedal and apply the parking brake.
2. Turn OFF all switches, shift to P (Park), and turn OFF the vehicle.
3. Open the charging door.

For more details, refer to "Charging door" on page 1-17.

4. Check whether there is dust or foreign substances inside the charging connector and charging inlet.

5. Hold the charging connector handle and connect it to the vehicle charging inlet. Push the connector all the way in. If the charging connector and charging terminal are not connected properly, this may cause a fire. Refer to the manual for each type of DC charger for how to charge and remove the charger.

6. Check if the charging indicator light (S) of the high voltage battery in the instrument cluster is turned ON. Charging is not active when the charging indicator light (S) is OFF. When the charging connector is not connected properly, reconnect the charging cable to charge it again. During cold weather, DC charging may not be available to prevent high voltage battery degradation.



7. After charging has started, the estimated charging time is displayed on the instrument cluster for about 1 minute. If you open the driver seat door while charging, the estimated charging time is also displayed on the instrument cluster for about 1 minute.

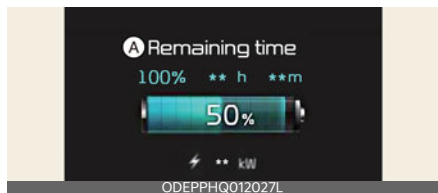

A: Remaining Time

Checking charging status

When charging the high voltage battery, the charge level can be checked from outside the vehicle.

For more details, refer to "Charge indicator lamp for electric vehicle" on page 1-15.

How to disconnect DC charger

1. Remove the charging connector when DC charging is completed, or after you stop charging using the DC charger. Refer to each respective DC charger manual for details about how to disconnect the charging connector.
2. Make sure to completely close the charging door.

* NOTICE

- If you use a DC charger when the vehicle is already fully charged, some DC chargers will send out an error message. When the vehicle is fully charged, do not charge the vehicle.
- If you cannot open the charging door due to freezing weather, tap lightly or remove any ice near the charging door. Do not try to forcibly open the charging door.
- To control the temperature of the high voltage battery while charging, the air conditioner is used to cool down the battery which may generate noise from operation of the air conditioner compressor and cooling fan. Also, the air conditioner's performance may be degraded during summer due to operation of the cooling system for the high voltage battery.
- Even though charging is possible with the START/STOP button in the ON/START position, for your safety, start charging when the START/STOP button is in the OFF position and the

vehicle shifted to P (Park). After charging has started, you can use electrical components such as the radio by pressing the START/STOP button to the ACC or ON position.

During charging, the gear cannot be shifted from P (Park) to any other gear.

- Depending on the condition and durability of the high voltage battery, charger specifications, and ambient temperature, the time required for charging the battery may vary.

Portable charge

Type A



Type B



- 1 Code and Plug (Code set)
- 2 Control Box
- 3 Charging Cable and Charging Connector

Portable Charge can be used when AC Charge or DC Charge is not available by using household electricity.

Setting the charge level of the portable charger

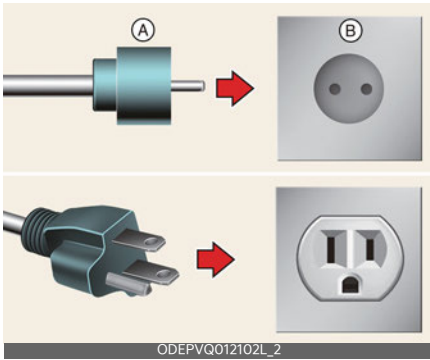

- A: Plug
- B: Electric Outlet

1. Check the rated current of the electric outlet prior to connecting the plug to the outlet.
2. Connect the plug to a household electric outlet.
3. Check the display window on the control box.

4. Press the button (1) on the back of the control box for 2~8 seconds to adjust the charge level. (Refer to charging cable type and example for setting the charge level.)

Type A



Type B



5. The charge level on the display window of the control box changes every time you press the button (1).
6. When setting the charge level is complete, start charging according to the portable charge procedure.

Example for setting the ICCB charge level (Type A)

Control box display window

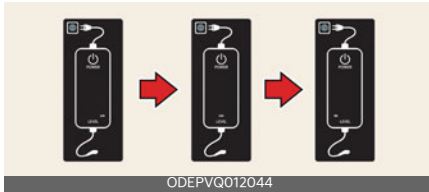

* The example is only for reference and may vary according to the surrounding environment

Outlet current	ICCB charge level
14~16A	12A
12~13A	10A
10~11A	8A

⚠ CAUTION

Please make sure that charge level selection matches the capacity of your circuit breaker to avoid blown fuse.

Example for setting the ICCB charge level (Type B)

Control box display window



* The example is only for reference and may vary according to the surrounding environment

Outlet current	ICCB charge level
14~16A	12A
12~13A	10A
10~11A	8A
8~9A	6A

⚠ CAUTION

Please make sure that charge level selection matches the capacity of your circuit breaker to avoid blown fuse.

How to connect portable charger (ICCB: In-Cable Control Box)

1. Connect the plug to a household electric outlet.

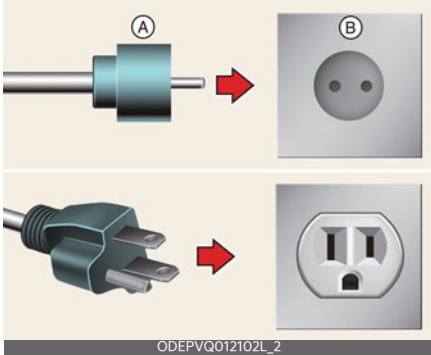

- A: Plug
- B: Electric Outlet

2. Check if the power lamp (green) appears on the control box.

Type A



Type B



3. Depress the brake pedal and apply the parking brake.
4. Turn OFF all switches, shift to P (Park), and turn OFF the vehicle. If charging is initiated without the gear in P (Park), the charging will start after the gear is automatically shifted to P (Park).
5. Open the charging door.
For more details, refer to "Charging door" on page 1-17.
6. Open the protection caps of the charging connector and the charging plug. Check if there are any foreign substances or dust.
7. Hold the charging connector handle and connect it to the vehicle charging inlet. Push the connector all the way in. If the charging connector and charging terminal are not connected properly, this may cause a fire.
8. Charging starts automatically (charging lamp appears).

Type A



Type B



9. Check if the charging indicator light (S) of the high voltage battery in the instrument cluster is turned ON. Charging is not active when the charging indicator light (S) is OFF. When the charging connector is not connected properly, reconnect the charging cable to charge it again.



10. After charging has started, the estimated charging time is displayed on the instrument cluster for about 1 minute.



A: Remaining Time

If you open the driver seat door while charging, the estimated charging time is also displayed on the instrument cluster for about 1 minute. When scheduled charging or scheduled air conditioner/heater is set, the estimated charging time is displayed as "-".

Checking charging status

When charging the high voltage battery, the charge level can be checked from outside the vehicle.

For more details, refer to "Charge indicator lamp for electric vehicle" on page 1-15.

*** NOTICE**

- If you cannot open the charging door due to freezing weather, tap lightly or remove any ice near the charging door. Do not try to forcibly open the charging door.
- When the charging connector and the charging inlet are connected, you can choose the mode by pressing button. The charging connector will be locked at a different time depending on the selected mode.
 - LOCK Mode: When the charging connector is properly connected, the charging connector will be automatically locked.
 - AUTO Mode: When the charging connector is properly connected and charging is initiated, the charging connector will be locked.
- Even though charging is possible with the START/STOP button in the ON/START position, for you safety, start charging when the START/STOP button is in the OFF position and the vehicle shifted to P (Park). After charging has started, you can use electrical components such as the radio by pressing the START/STOP button to the START or ON position. During charging, the gear cannot be shifted from P (Park) to any other gear.
- Depending on the condition and durability of the high voltage battery, charger specifications, and ambient temperature, the time required for charging the battery may vary.

Charging status indicator lamp for portable charger (Type A)







Indicator		Status
PLUG	(Green) 	<ul style="list-style-type: none"> ON: Power on Blink: Plug temperature sensor failure
	(Red) 	<ul style="list-style-type: none"> ON: Plug high temperature protection Blink: Plug high temperature warning
POWER		<ul style="list-style-type: none"> ON: Power on
CHARGE		<ul style="list-style-type: none"> Blink: Charging in power saving mode * (Only the CHARGE indicator appears)
FAULT		<ul style="list-style-type: none"> Blink: Charging interrupted
CHARGE LEVEL		<ul style="list-style-type: none"> Charging current 12 A
		<ul style="list-style-type: none"> Charging current 10 A
		<ul style="list-style-type: none"> Charging current 8 A





Indicator		Status
VEHICLE	(Green) 	<ul style="list-style-type: none"> Charging connector plugged
	(Blue) 	<ul style="list-style-type: none"> Charging
	(Red) 	<ul style="list-style-type: none"> Blink: Charging impossible

* NOTICE

The charging current changes (3 level) whenever the button (1) is pressed for 1 sec with the charger plugged into an electrical outlet but not the vehicle.



No	Control Box	Status/Diagnosis/Countermeasure
1	 <p>ODEPVQ012056</p>	<ul style="list-style-type: none"> • Charging connector plugged into vehicle (Green ON) • Plug temperature sensor failure (Green blink) • Plug high temperature protection (Red blink) • Plug high temperature warning (Red ON) <p>* Have the system inspected by a professional workshop. Kia recommends to visit an authorized Kia dealer/service partner.</p>
2	 <p>ODEPVQ012057</p>	<ul style="list-style-type: none"> • Charging connector plugged into vehicle (Green ON)
3	 <p>ODEPVQ012058</p>	<ul style="list-style-type: none"> • While charging <ul style="list-style-type: none"> - Charge indicator (Green blink) - Vehicle indicator (Blue ON)
4	 <p>ODEPVQ012059</p>	<ul style="list-style-type: none"> • Before plugging charging connector into vehicle (Red blink) <ul style="list-style-type: none"> - Abnormal temperature - ICCB (In-Cable Control Box) failure <p>* Have the system inspected by a professional workshop. Kia recommends to visit an authorized Kia dealer/service partner.</p>

No	Control Box	Status/Diagnosis/Countermeasure
5	 <p data-bbox="273 459 378 475">ODEPVQ012060</p>	<ul style="list-style-type: none"> • Plugged into vehicle (Red blink) <ul style="list-style-type: none"> - Diagnostic device failure - Current leakage - Abnormal temperature <p>* Have the system inspected by a professional workshop. Kia recommends to visit an authorized Kia dealer/service partner.</p>
6	 <p data-bbox="273 751 378 767">ODEPVQ012061</p>	<ul style="list-style-type: none"> • After plugging charging connector into vehicle (Red blink) <ul style="list-style-type: none"> - Communication failure <p>* Have the system inspected by a professional workshop. Kia recommends to visit an authorized Kia dealer/service partner.</p>
7	 <p data-bbox="273 1043 378 1059">ODEPVQ012062</p>	<ul style="list-style-type: none"> • Plug temperature sensor failure (Green blink) • Plug high temperature protection (Red blink) • Plug high temperature warning (Red ON) <p>* Have the system inspected by a professional workshop. Kia recommends to visit an authorized Kia dealer/service partner.</p>
8	 <p data-bbox="273 1335 378 1351">ODEPVQ012063</p>	<ul style="list-style-type: none"> • Power saving mode <ul style="list-style-type: none"> - 3 minutes after charging starts (Green blink)

Charging status indicator lamp for portable charger (Type B)



Indicator		Details
POWER		On: Power on
CHARGE		On: Charge Blink: Current limit due to high plug temperature or high internal temperature
FAULT		Blink: Charging interrupted
CHARGE LEVEL	12	12 A
	10	10 A
	08	8 A
	06	6 A
	The charging current changes whenever the button (1) is pressed for less than 1 sec with the charger plugged into an electrical outlet but not the vehicle.	
<p>Control box</p> <p>OCVQ011021L</p>		

1

Status/Diagnosis/Countermeasure

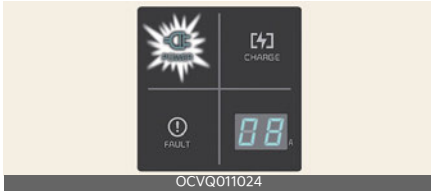

- Charging connector plugged into vehicle (**POWER** Green ON)
- Plug connected to an electric outlet (**POWER** Green ON)

Plugged into vehicle (POWER Green ON, FAULT Red Blink)



- Diagnostic device failure
- Current leakage
- Abnormal temperature

While charging



- Charge indicator (**POWER** Green ON/**CHARGE** Blue ON)
- Charging current

Leakage current failure (POWER Green ON, FAULT Red Blink)



- After disconnecting and reconnecting the power plug, press and release the button for 2 seconds or longer to clear the error.

Before plugging charging connector into vehicle (POWER Green ON, FAULT Red blink)



- Abnormal temperature
- ICCB (In-Cable Control Box) failure

Power saving mode



- Charge level indicator is turned off if there is no status change for more than 1 minute.

How to disconnect portable charger (ICCB: In-Cable Control Box)

1. Hold the charging connector handle (1) and pull it out.

Type A



Type B



2. Make sure to completely close the charging door.
3. Disconnect the plug from the household electric outlet. Do not pull the cable when disconnecting the plug.

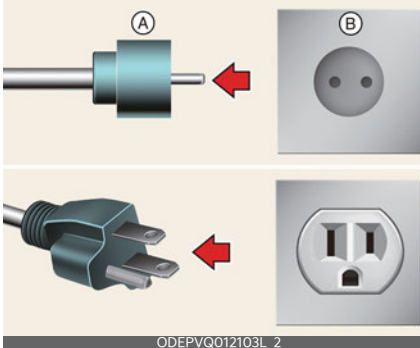

A: Plug

B: Electric Outlet

4. Close the protection caps of the charging connector and the charging

plug to protect them from foreign substances.

5. If the personal charging connector is used, store the connector in the cable compartment.

Precautions for portable charger (ICCB: In-Cable Control Box)

- Use the portable charger that is certified by an authorized Kia dealer/service partner.
- Do not try to repair, disassemble, or adjust the portable charger.
- Do not use an extension cord or adapter.
- Stop using immediately when failure occurs.
- Do not touch the plug and charging connector with wet hands.
- Do not touch the terminal part of the AC charging connector and the AC charging inlet on the vehicle.
- Do not connect the charging connector to voltage that does not comply with regulations.
- Do not use the portable charger if it is worn out, exposed, or there exists any type of damage on the portable charger.
- If the ICCB case and AC charging connector is damaged, cracked, or the wires are exposed in any way, do not use the portable charger.
- Do not let children operate or touch the portable charger.
- Keep the control box free of water.
- Keep the normal charging connector or plug terminal free of foreign substances.
- Do not step on the cable or cord. Do not pull the cable or cord and do not twist or bend it.

- Do not charge when there is lightning.
- Do not drop the control box or place a heavy object on the control box.
- Do not place an object that can generate high temperatures near the charger when charging.
- Charging with the worn out or damaged household electric outlet can result in a risk of electric shock. If you are in doubt to the household electric outlet condition, have it checked by a licensed electrician.
- Stop using the portable charger immediately if the household electric outlet or any components is overheated or you notice burnt odors.

we recommend to visit an authorized Kia dealer/service partner.

* NOTICE

To prevent charging cable theft, the charging connector cannot be disconnected from the inlet when the doors are locked or the charging connector is in the LOCK mode. Unlock all doors to disconnect the charging connector from the inlet.

However, if the vehicle is in the charging connector AUTO mode, the charging connector automatically unlocks from the inlet when charging is completed.

If the charging connector is disconnected while the release button is not pressed, the connector and the inlet may be damaged.

For more details, refer to "Charging connector lock" on page 1-15.

If the release button does not work even after the all doors are unlocked, pull the emergency lift cable in the motor room and press the release button in the connector to disconnect it from the vehicle. If the release button still does not work,

Charging the electric vehicle (Abrupt stop)

Action to be taken when charging stops abruptly

When the high voltage battery does not charge, check the followings:

- Check the charging setting for the vehicle. Refer to "EV settings" on page 1-10 (e.g. When scheduled charging is set, charging is not initiated immediately when the AC charger or portable charger (ICCB: In-Cable Control Box) is connected.)
- Check the operation status of AC charger, portable charger and DC charger. (Refer to "Charging status" on page 1-15)
 - * Actual method for indicating the charging status may vary in accordance with the charger manufacturer.
- When the vehicle does not charge and a warning message appears on the cluster, check the corresponding message. Refer to "LCD display messages" on page 1-41.
- If the vehicle is properly charged when charged with another normally working charger, contact the charger manufacturer.
- If the vehicle does not charge when charged with another normally working charger, we recommend that you contact an authorized Kia dealer/service partner for inspection.
- If charging fails and the service warning light (⚠️) is lit in the cluster, we recommend that you contact an authorized Kia dealer/service partner.

Driving electric vehicle

This section describes how to start and stop the vehicle, what is displayed on the various gauges and LCD displays, and so on.

Starting the vehicle

1. Holding the smart key, sit in the driver's seat.
2. Fasten the seat belt before starting the vehicle.
3. Make sure to engage the parking brake.
4. Check the position of the accelerator pedal and the brake pedal and the clearance with your right foot.
5. Make sure to depress and hold the brake pedal.
6. While depressing the brake pedal, shift to P (Park).
7. Depress and hold the brake pedal while pressing the START/STOP button.
8. When the (🚗) indicator is ON, you can drive the vehicle. When the (🚗) indicator is OFF, you cannot drive the vehicle. Restart the vehicle.

Vehicle ON



9. Depress and hold the brake pedal and shift to the desired position
10. Release the parking brake and slowly release the brake pedal. Check if the vehicle slowly moves forward, then depress the accelerator pedal.

Stopping the vehicle

1. Hold down the brake pedal while the vehicle is parked.
2. Shift to P (Park).
3. Engage the parking brake.
4. Press the START/STOP button and turn off the vehicle.
5. Check if the (🚗) indicator is turned OFF in the instrument cluster. When the (🚗) indicator is ON and the gear is in a position other than P (Park), the driver can accidentally depress the accelerator pedal, causing the vehicle to move unexpectedly.

Vehicle OFF



Virtual Engine Sound System (VESS)

The Virtual Engine Sound System (VESS) generates an engine sound for pedestrians to hear the vehicle because there is no sound while the Electric Vehicle (EV) is operating.

If the vehicle is in the ready mode and the gear is not in P (Park), the VESS will operate.

When the gear is shifted to R (Reverse), an additional warning sound will be heard.

⚠️ WARNING

The sound system only plays a supplementary role. The system is not designed to and does not replace the care of drivers. Drivers should always pay attention to their surroundings while driving.

⚠️ CAUTION

- The vehicle does not generate an engine sound. Be aware of your driving environment and drive safely.
- After you park the vehicle or while you are waiting at a traffic light, check whether there are children or obstacles around the vehicle.
- Check if there is something behind the vehicle when driving in reverse. Pedestrians may not hear the sound of the vehicle.

Distance to empty



The distance to empty is displayed differently according to the selected drive mode in the Drive Mode Integrated Control System.

For more information, refer to "Drive mode integrated control system" on page 6-31.

- On average, a vehicle can drive about 427 km.

- Under certain circumstances where the air conditioner/heater is ON, the distance to empty is impacted, resulting in a possible distance range from 280~500 km. When using the heater during cold weather or driving at high speed, the high voltage battery consumes a lot more electricity. This may reduce the distance to empty significantly.
- After '---' has been displayed, charge the vehicle immediately. The vehicle can drive an additional 3~8 km (2~5 miles) depending on driving speed, heater/air conditioner, weather, driving style, and other factors. Drive your vehicle for approximately 50 km/h (30 mph) to the nearest charging station.
- Distance to empty that is displayed on the instrument cluster after completing a recharge may vary significantly depending on previous operating patterns.
When previous driving patterns include high speed driving, resulting in the high voltage battery using more electricity than usual, the estimated distance to empty is reduced. When the high voltage battery uses little electricity in **ECO** mode, the estimated distance to empty increases.
- Distance to empty may depend on many factors such as the charge amount of the high voltage battery, weather, temperature, durability of the battery, geographical features, and driving style. When the outside temperature drops, such as in winter, the distance to empty may decrease due to battery performance degradation.
- Natural degradation may occur with the high voltage battery depending on the number of years the vehicle is used. This may reduce the distance to empty.

Tips for improving Distance to empty

- If you operate the air conditioner/heater too much, the driving battery uses too much electricity. This may reduce the distance to empty. Therefore, it is recommended that you set the cabin temperature to 22 °C (72 °F) **AUTO**. This setting that has been certified by various assessment tests to maintain optimal energy consumption rates while maintaining a comfortable temperature. Turn off the heater and air conditioner if you do not need them. However, continuously turning it on and off is not recommended.
- When the heater or air conditioning system is on the energy consumption is reduced if recirculation mode is selected instead of selecting the fresh mode. The fresh mode requires large amount of energy consumption as the outside air has to be re-heated or cooled.
- When using the heater or air conditioning system, use the **DRIVER ONLY** or scheduled air conditioner/heater function.
- Depress and hold the accelerator pedal to maintain speed and drive economically.
- Gradually depress and release the accelerator pedal when accelerating or decelerating.
- Always maintain specified tire pressures.

- Do not use unnecessary electrical components while driving.
- Do not load unnecessary items in the vehicle.
- Do not mount parts that may increase air resistance.

ECO driving

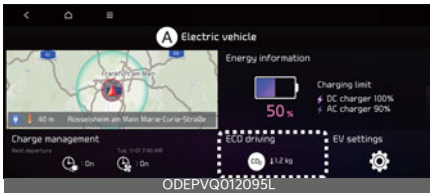

A: Electric vehicle

In order to check the ECO driving history, select **ECO driving** menu on the screen.

Electric energy economy history



A: ECO driving

1 Energy consumption history

It is possible to check the history of electric energy economy with the date and distance of previous driving. The icon is displayed on the most efficient electric energy economy record.

Environment contribution

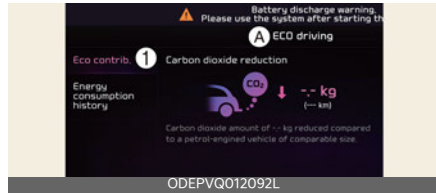

A: ECO driving

1 Carbon dioxide reduction

Information on CO2 reduction compared to gasoline-fueled vehicles is displayed.

Energy consumption

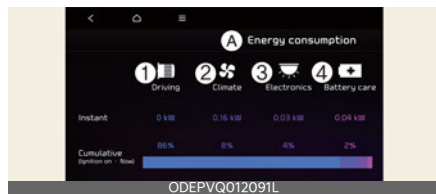

A: Energy information

1 Energy consumption

2 Driving

3 Climate

4 Electronics

5 Battery care

In order to check the current energy consumption for each system of the vehicle, select **ECO driving** menu on the screen.

1. **Driving** shows the total power and energy consumption of the driving motor's driving energy and regenerative energy.
2. **Climate** shows the power and energy consumption which are used by the heater or air conditioner.
3. **Electronics** shows the power and energy consumption which are used by the vehicle systems including the cluster, infotainment system (speaker

and navigation), headlamp, vehicle control unit, etc.

4. **Battery care** shows the momentary power and energy consumption which are used when:

- Operating the winter mode to increase the battery temperature during winter to improve the driving performance.
- Cooling down the battery temperature during summer to prevent over temperature of the battery.

* NOTICE

The infotainment system may change after software updates. For more information, refer to the manual provided in the infotainment system and the quick reference guide.

Power/Charge gauge

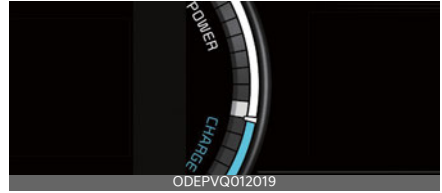

The Power/Charge Gauge shows the energy consumption rate of the vehicle and the charge/discharge status of the regenerative brakes.

- Power: It shows the energy consumption rate of the vehicle when driving uphill or accelerating. The more electric energy is used, the higher the gauge level.
- Charge: It shows the charging status of the battery when it is being charged by the regenerative brakes (decelerating or driving on a downhill road). The more electric energy is charged, the lower the gauge level.

State of charge (SOC) gauge for high voltage battery



The SOC gauge shows the charging status of the high voltage battery.

If the gauge is near the "O (L)" level, there is not enough energy in the high voltage battery. Full gauge indicates that the driving battery is fully charged.

When driving on highways or motorways, make sure to check in advance if the driving battery is charged enough.



When there are 2 gauge bars (near the "0 (L)" area) on the SOC gauge, the warning light (🔋⚡) turns ON to alert you of the battery level.

When the warning light (🔋⚡) turns ON, the vehicle can drive an additional 20~30 km (12~18 miles) depending on the driving speed, heater/air conditioner, weather, driving style, and other factors. Charging is required.

*** NOTICE**

When there are 1~2 gauge bars left for the high voltage battery, the vehicle speed is limited and then eventually the vehicle will turn OFF. Charge the vehicle immediately.

Warning and indicator lights (related to electric vehicle)

Ready indicator 🚗

- This indicator appears:
 - When the vehicle is ready to be driven.
 - ON: Normal driving is possible.
 - OFF: Normal driving is not possible, or a problem has occurred.
 - Blinking: Emergency driving.

When the ready indicator goes OFF or blinks, there is a problem with the system. In this case, we recommend to visit an authorized Kia dealer/service partner.

Service warning light ⚠️

This warning light appears:

- When the START/STOP button is in the ON position.
 - It appears for approximately 3 seconds and then goes off.
- When there is a problem with related parts of the electric vehicle control system, such as sensors, etc.

When the warning light appears while driving, or does not go OFF after starting the vehicle, we recommend to visit an authorized Kia dealer/service partner.

Power down indicator light 🚫

This indicator light appears:

- When the START/STOP button is in the ON position.
 - It appears for approximately 3 seconds and then goes off.
- When the power is limited for the safety of the high-powered parts of an electric vehicle. The power is limited for the following reasons. (Unless both Service warning light and Power down indicator light appear at the same time, it is not a failure.)
 - The high voltage battery level is too low or voltage is decreasing
 - The temperature of the high voltage battery is too high or too low
 - The temperature of the motor is high

*** NOTICE**

- Do not accelerate or start the vehicle suddenly when the power down indicator light is ON.

- When the power is limited for the safety of the high-powered parts of an electric vehicle, the power down indicator light appears. Your vehicle may not be driven, or may roll back on a slope with the indicator light ON.

Charging indicator light

This warning light appears:

- When the charging connector is connected to charge the high voltage battery.

High voltage battery level warning light

This warning light appears:

- When the high voltage battery level is low.
- When the warning light turns ON, charge the battery immediately.

Regenerative brake warning light (red color) (yellow color)

This warning light appears:

- When the regenerative brake does not operate and the brake does not perform well. This causes the brake warning light (red) and Regenerative Brake Warning Light (yellow) to appear simultaneously.

In this case, drive safely and we recommend that you have your vehicle inspected by an authorized Kia dealer/service partner.

The operation of the brake pedal may be more difficult than normal and the braking distance can increase.

LCD display messages

Shift to P to start charging



A: Shift to P to start charging

This message is displayed if you connect the charging cable without the gear in the P (Park) position.

Shift to P (Park) before connecting the charging cable.

Low battery

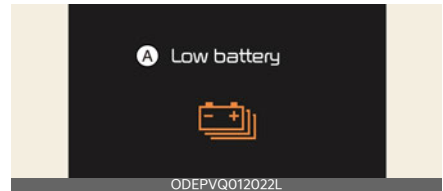

A: Low battery

When the high voltage battery level reaches around 8% or less, this warning message is displayed.

The warning light on the instrument cluster () will turn on simultaneously. Charge the battery immediately.

Charge immediately. Power limited



A: Charge immediately. Power limited

When the high voltage battery level reaches around 5% or less, this warning message is displayed.

The warning light on the instrument cluster (⚠️) and the power down indicator light (🛑) will turn on simultaneously. The vehicle's power will be reduced to minimize the energy consumption of the high voltage battery. Charge the battery immediately.

Check electric vehicle system

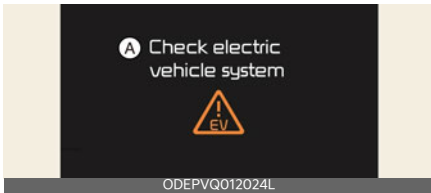

A: Check electric vehicle system

This warning message is displayed when there is a problem with the electric vehicle control system.

⚠️ WARNING

Refrain from driving when the warning message is displayed.

If this occurs, park the vehicle in a safe location and we recommend that you tow your vehicle to the nearest authorized Kia dealer/service partner and have the vehicle inspected.

Power limited

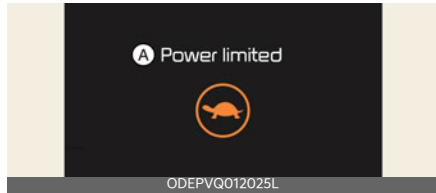

A: Power limited

In the following cases, this warning message is displayed when the vehicle's power is limited for safety.

- When the power is limited for the safety of the high-powered parts of an electric vehicle. The power is limited for the following reasons. (Unless both Service warning light and Power down indicator light appear at the same time, it is not a failure.)
- The high voltage battery level is too low or voltage is decreasing.
- The temperature of the high voltage battery is too high or too low.
- The temperature of the motor is high.

⚠️ WARNING

When this warning message is displayed, do not accelerate or start the vehicle suddenly. Charge the battery immediately when the high voltage battery level is not enough.

* NOTICE

When the power is limited for the safety of the high-powered parts of an electric vehicle, the power down indicator light appears. Your vehicle may not be driven, or may roll back on a slope with the indicator light ON.

Power limited due to low EV battery temperature. Charge battery

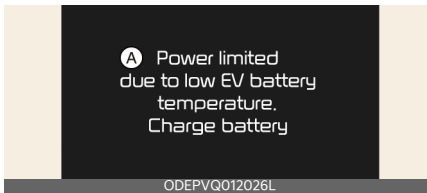

A: Power limited due to low EV battery temperature. Charge battery

The warning message is displayed to protect the electric vehicle system when you turn off the vehicle while outside temperature is low. If the high voltage battery charging level is low and parked outside in low temperature for a long time, vehicle power could be limited. Charging the battery before driving, increases the battery temperature, and helps increase power.

⚠ CAUTION

- If this warning message is still displayed even when the ambient temperature is sufficiently high, have the vehicle inspected by an authorized Kia dealer/service partner.
- When the battery temperature is extremely low in winter, the battery temperature optimization is conducted for normal driving conditions. The optimization time may vary depending on the battery temperature and charging conditions.
- If the high voltage battery level and temperature is too low, the power may be limited. When the warning message is displayed, please charge the vehicle immediately.



A: Charge immediately. Power limited

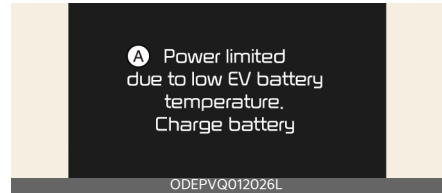

A: Power limited due to low EV battery temperature. Charge battery

Battery overheated! Stop safely and leave the vehicle

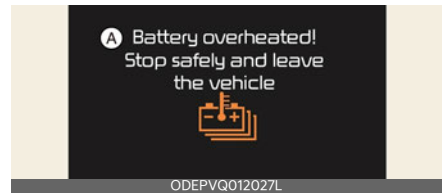

A: Battery overheated! Stop safely and leave the vehicle

This warning message is displayed to protect battery and electric vehicle system when the high voltage battery temperature is too high.

Turn off the START/STOP button and stop the vehicle so that the battery temperature decreases.

⚠ WARNING

If this warning is still displayed even after the START/STOP button has been turned off for sufficient time, refrain from driving and have the vehicle inspected by an authorized Kia dealer/ service partner.

Stop safely and check power supply

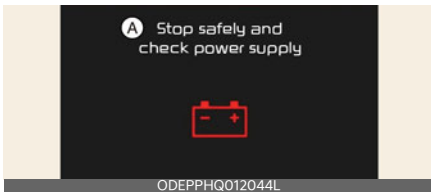

A: Stop safely and check power supply

This warning message is displayed when a failure occurs in the 12 V power supply system.

If this occurs, park the vehicle in a safe location and we recommend that you tow your vehicle to the nearest authorized Kia dealer/service partner and have the vehicle inspected.

Unplug vehicle to start



A: Unplug vehicle to start

This message is displayed when you start the vehicle, without unplugging the charging cable, and will not shift out of park. Unplug the charging cable, and then turn on the vehicle.

Charging door open

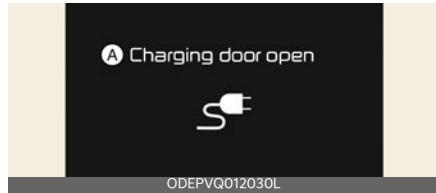

A: Charging door open

This message is displayed when the vehicle is driven with the charging door opened. Close the charging door and then start driving.

Remaining Time

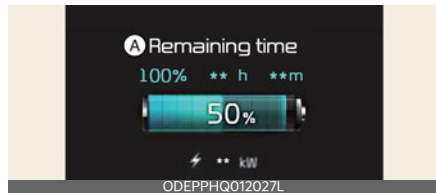

A: Remaining Time

* The remaining charging time in the LCD image may differ from actual charging time.

This message is displayed to notify the remaining time to charge the battery, to the selected target battery charge level, and the charge voltage level.

Charging stopped. Please check the charger

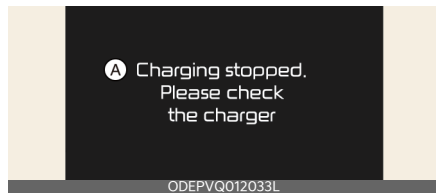

A: Charging stopped. Please check the charger

This warning message is displayed when charging is stopped for the reasons below:

- There is a problem with the external AC charger or DC charger.
- The external AC charger stopped charging
- The charging cable is damaged.

If this occurs, check whether there is any problem with the external AC or DC charger and charging cable.

If the same problem occurs when charging the vehicle with a well-functioning external charger or genuine Kia portable charger, have your vehicle inspected by an authorized Kia dealer/service partner.

Charging interrupted. Please check the cable connection

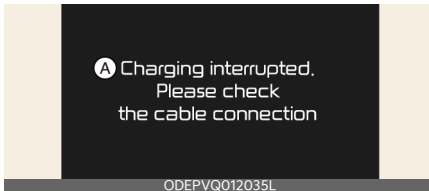

A: Charging interrupted. Please check the cable connection

This warning message is displayed for the reasons below:

- The charging connector is not correctly connected to the charging inlet.
- The charging connector lock release button is pressed.

If this occurs, separate the charging connector and re-connect it.

Check whether there is any problem (external damage, foreign substances, etc.) with the charging connector and charging inlet.

If the same problem occurs when charging the vehicle with a replaced charging cable or genuine Kia portable charger, we recommend that you have your vehicle inspected by an authorized Kia dealer/service partner.

Check regenerative brakes

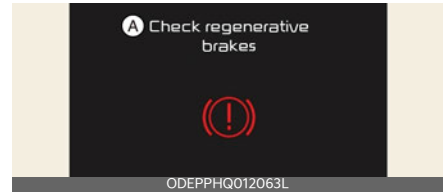

A: Check regenerative brakes

This warning message is displayed when the regenerative brake system does not work properly.

In this case, we recommend to visit an authorized Kia dealer/service partner.

Check virtual engine sound system

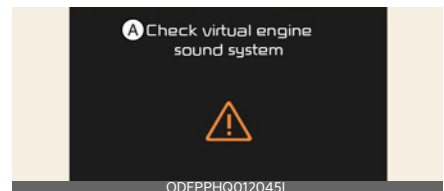

A: Check virtual engine sound system

This message is displayed when there is a problem with the Virtual Engine Sound System (VESS).

In this case, we recommend to visit an authorized Kia dealer/service partner.

Check Active Air Flap system



A: Check Active Air Flap system

This warning message is displayed in the following situations:

- There is a malfunction with the actuator flap
- There is a malfunction with the actuator air flap controller
- The air flap does not open

When all of the above conditions are fixed, the warning will disappear.

Refill motor system coolant

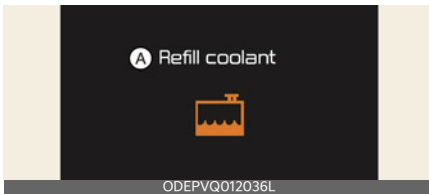

A: Refill motor system coolant

This message is displayed when the coolant is low. If the warning message is displayed, stop driving and check the amount of coolant. Driving under coolant for a prolonged period of time can cause serious problems with the vehicle's electrical equipment and make normal driving impossible.

12V Aux. Battery Saver+ (if equipped)

The Aux. Battery Saver+ is a function that monitors the charging status of the 12V auxiliary battery. If the auxiliary battery level is low, the main high voltage battery charges the auxiliary battery.

The Aux. Battery Saver+ function will be ON when the vehicle is delivered.

Cycle Mode

When the START/STOP button is in the OFF position with all doors, hood and tailgate closed, the Aux. Battery Saver+ activates according to the auxiliary battery status.

Automatic Mode

When the START/STOP button is in the ON position with the charging connector plugged in, the function activates according to the auxiliary battery status to prevent over discharge of the auxiliary battery.

⚠ WARNING

When the function is activating, the charging indicator lamp will appear and 360V high voltage electricity will be flowing in the vehicle. Do not touch, separate or disassemble all the electric and electronic components and devices including the high voltage electric wire, connector. This may cause electric shock and lead to fatal injuries. Also, do not modify your vehicle in any way. This may affect your vehicle performance and lead to an accident.

⚠ CAUTION

- The Aux. Battery Saver+ function cannot prevent battery discharge if the auxiliary battery is damaged, worn out, used as a power supply or unauthorized electronic devices are used.
- If the Aux. Battery Saver+ function was activated, the high voltage battery level may have decreased.

*** NOTICE**

The Aux. Battery Saver+ activates maximum of 20 minutes. If the Aux. Battery Saver+ function activates more than 10 times consecutively when in the automatic mode, the function will stop activating, judging that there is a problem with the auxiliary battery. In this case, drive the vehicle for some period of time or if the auxiliary battery returns to normal, the function will start activating.

Safety precautions for electric vehicle**If an accident occurs**

If towing is required, tow the vehicle with a flatbed equipment or dollies with all wheels off the ground.

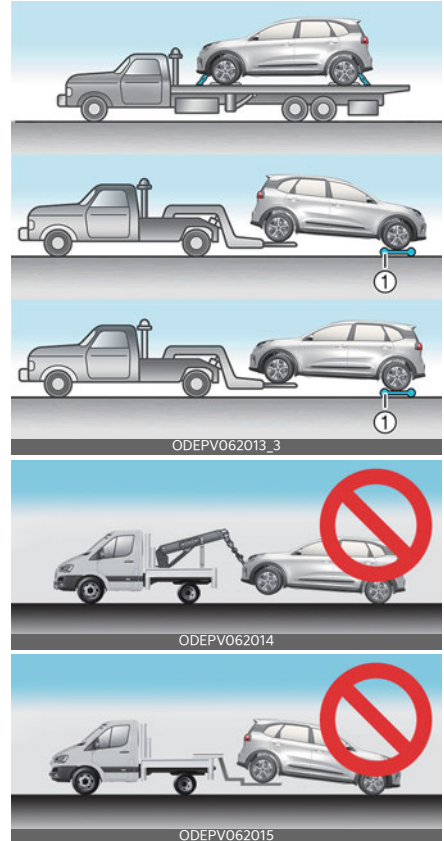
**1 Dollies**

If you must tow the vehicle using only two wheels, lift the rear wheels off the ground and tow the vehicle.

If necessary to roll the vehicle so that it can be rolled onto a flatbed tow truck perform the following:

- First, depress the brake pedal and release the parking brake.
- Wait 3 minutes or more before opening the driver door and the vehicle will remain in ACC mode and in N (Neutral).
- If the driver door is opened within the 3 minute period, the vehicle will automatically shift to P (Park), the vehicle will turn OFF and the front wheels will be remained locked.

Service interlock connector



Pull or cut the service interlock connector to cut off the high voltage of the battery in an emergency. Service interlock connector cannot be reused when cut.

Service plug

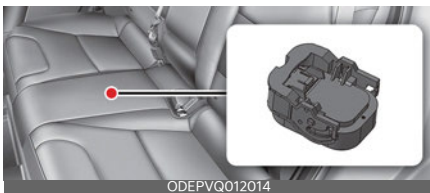

⚠ DANGER

Never touch the safety plug. Safety plug is attached to high voltage hybrid battery system. Touching safety plug will result in death or serious injury. Service personnel should follow procedure in service manual.

Other precautions for electric vehicle

- When you paint, apply heat treatment to the vehicle as a result of an accident, and/or weld on the vehicle, the performance of the high voltage battery can be reduced. If heat treatment is required, have the vehicle serviced by an authorized Kia dealer/service partner and have the HV battery removed, prior to any repairs.

⚠ WARNING

- When a vehicle accident occurs, move the vehicle to a safe place, turn OFF the vehicle and remove the auxiliary battery (12 V) terminal to prevent high voltage electricity from flowing.
- If electric wires are exposed from inside or outside the vehicle, do not touch the wires. Also, do not touch the high voltage electric wire (orange), connector, or any of the electric components and devices. This may cause electric shock and lead to injuries.
- When a vehicle accident occurs and the high voltage battery is damaged, harmful gas and electrolytes may leak. Be careful not to touch the leaked liquid.

When you suspect leakage of inflammable gas and other harmful gases, open the windows and evacuate to a safe place. If any leaked fluid comes in contact with your eyes or skin, immediately clean the affected area thoroughly with tap water or saline solution and have doctors inspect it as soon as possible.

- If a small scale fire occurs, use a fire extinguisher (ABC, BC) that is meant for electrical fires. If it is impossible to extinguish the fire in the early stage, maintain a safe distance away from the vehicle and immediately call your local fire emergency responders. Also, advise them that an electric vehicle is involved.

If the fire spreads to the high voltage battery, large amounts of water is needed to put out the fire. Using small amounts of water or fire extinguishers not meant for electrical fires could cause serious injury or death from electrical shocks.

- If you cannot put out the fire immediately, the high voltage battery may explode. Evacuate to a safe place and do not let other people approach the site.

Contact the fire department and notify them of an electric vehicle fire.

If the vehicle is flooded with water, immediately turn OFF the vehicle and evacuate to a safe place. Contact the fire department or an authorized Kia dealer/service partner.

- If you tow the vehicle while the front wheels are touching the ground, the vehicle motor may generate electricity and the motor components may be damaged or a fire may occur.



ODEPV062015

- When a vehicle fire occurs due to the battery, there is a risk of a second fire. Contact your local fire emergency responders when towing the vehicle.
- When you clean the motor compartment, do not use high pressure water to wash. This may cause an electric shock due to a discharge in high voltage electricity, or damage the vehicle's electric system.
- Never disconnect the service interlock connector except in an emergency situation. Serious problems may occur, such as the vehicle will not start.

⚠ CAUTION

Use, remodel, or install only Kia Genuine Parts or those of an equivalent standard. If not, this may damage the electric power system.

*** NOTICE**

Putting the excessive force to the switch lever while shutting down the high voltage battery may severely damage the service interlock connector.

Vehicle modifications.....	2-2
Vehicle handling instructions	2-2

Introduction

Vehicle modifications

This vehicle should not be modified. Modification of your vehicle could affect its performance, safety or durability and may even violate governmental safety and emissions regulations.

In addition, damage or performance problems resulting from any modification may not be covered under warranty.

- Use of unauthorized electronic devices may cause abnormal operation of the vehicle, wire damage, battery discharge, or fire. For your safety, do not use unauthorized electronic devices.

Vehicle handling instructions

As with other vehicles of this type, failure to operate this vehicle correctly may result in loss of control, accident, or vehicle rollover.

Specific design characteristics (higher ground clearance, track, etc.) give this vehicle a higher center of gravity than other types of vehicles. In other words, it is not designed for cornering at the same speeds as conventional 2-wheel-drive vehicles.

Avoid sharp turns and abrupt maneuvers. Again, failure to operate this vehicle correctly may result in loss of control, accident, or vehicle rollover.

Be sure to read the "Reducing the risk of a rollover" on page 6-110.

Your vehicle at a glance **3**

Exterior overview	3-2
Interior overview	3-4
Instrument panel overview	3-7
Motor room compartment.....	3-10

Your vehicle at a glance

Exterior overview

Front view



ODEPV012001

* The actual features in your vehicle may not necessarily be available due to the selected options or regions.

- | | |
|----------------------------------|------------|
| 1. Hood | 5-20 |
| 2. Head lamp | 5-42, 8-36 |
| 3. Wheel and tire | 8-15, 9-5 |
| 4. Outside rear view mirror | 5-26 |
| 5. Front windshield wiper blades | 5-48, 8-11 |
| 6. Windows | 5-16 |
| 7. Front ultrasonic sensors | 6-98 |
| 8. Front radar | 6-34, 6-70 |
| 9. Front view camera | 6-34 |
| 10. Charging door | 5-21 |

11. Day time running lamp/Position lamp

8-36

Rear view



ODEPV012002L

* The actual features in your vehicle may not necessarily be available due to the selected options or regions.

1. Doors	5-9
2. Rear combination lamp	8-36
3. High mounted stop lamp	8-36
4. Tailgate	5-15
5. Antenna	5-73
6. Wide-rear view camera	6-88
7. Rear ultrasonic sensors	8-95, 6-98
8. Rear wiper	5-48, 8-11
9. Rear turn signal lamp	8-36, 8-38
10. Backup lamp/Rear fog lamp	8-36

Interior overview

Left-hand drive

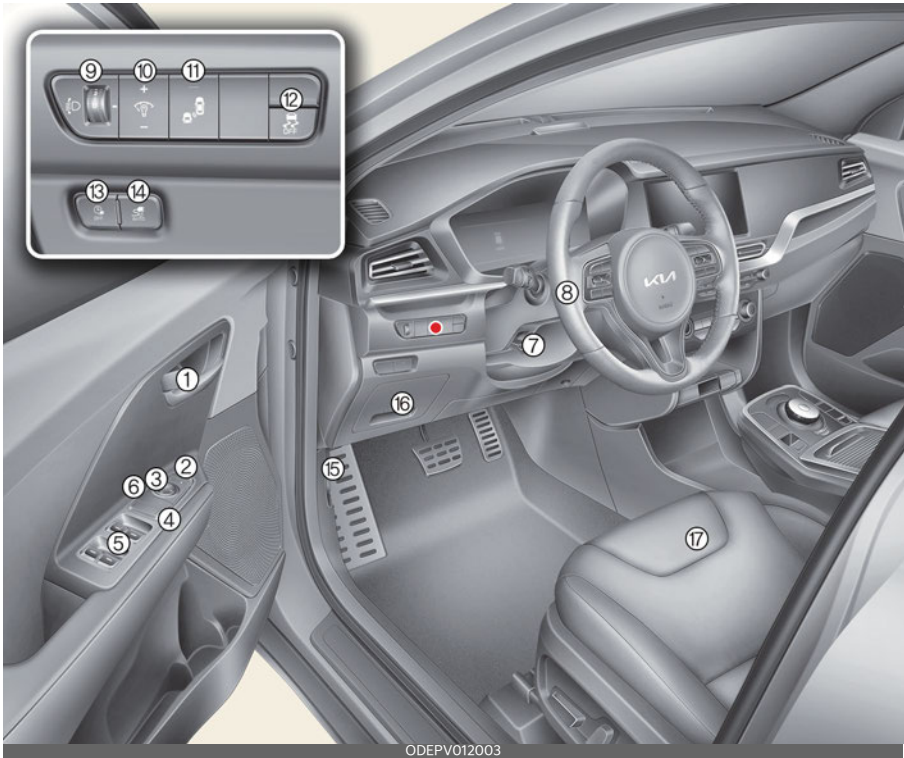

Right-hand drive

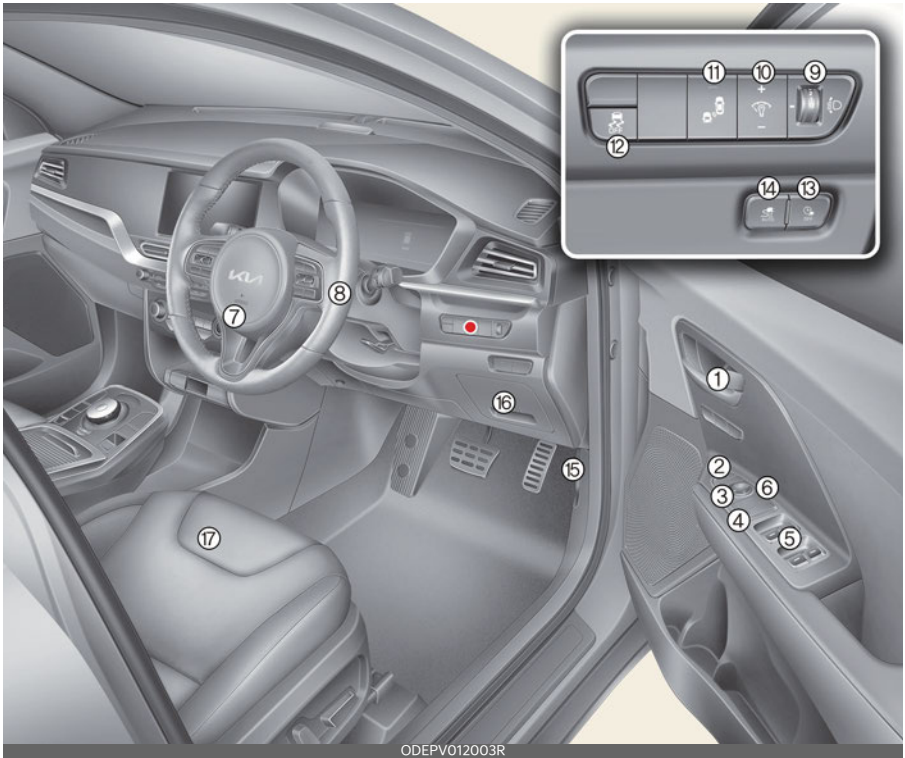

3

* The actual features in your vehicle may not necessarily be available due to the selected options or regions.

- | | |
|--|------|
| 1. Inside door handle | 5-9 |
| 2. Outside rearview mirror folding switch | 5-26 |
| 3. Outside rearview mirror control switch | 5-26 |
| 4. Central door lock/unlock switch | 5-11 |
| 5. Power window switches | 5-18 |
| 6. Power window lock | 5-19 |
| 7. Steering wheel tilt/telescopic lever | 5-23 |
| 8. Steering wheel | 5-23 |
| 9. Headlamp leveling adjustment switch | 5-47 |
| 10. Instrument cluster illumination control button | 5-30 |
| 11. Blind-Spot Safety button | 6-51 |
| 12. ESC OFF button | 6-28 |
| 13. Scheduled charging deactivation button | 1-16 |

14.Charging connector AUTO/LOCK button	1-15
15.Hood release lever	5-20
16.Instrument panel fuse	8-22
17.Seat	4-3

Instrument panel overview

Left-hand drive

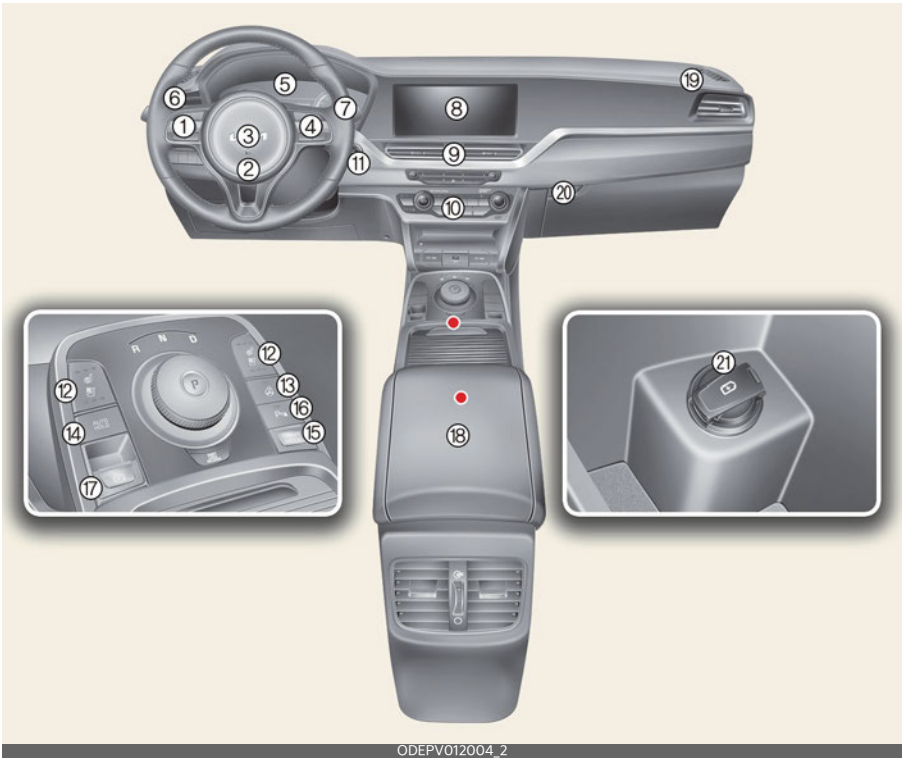

3

Right-hand drive

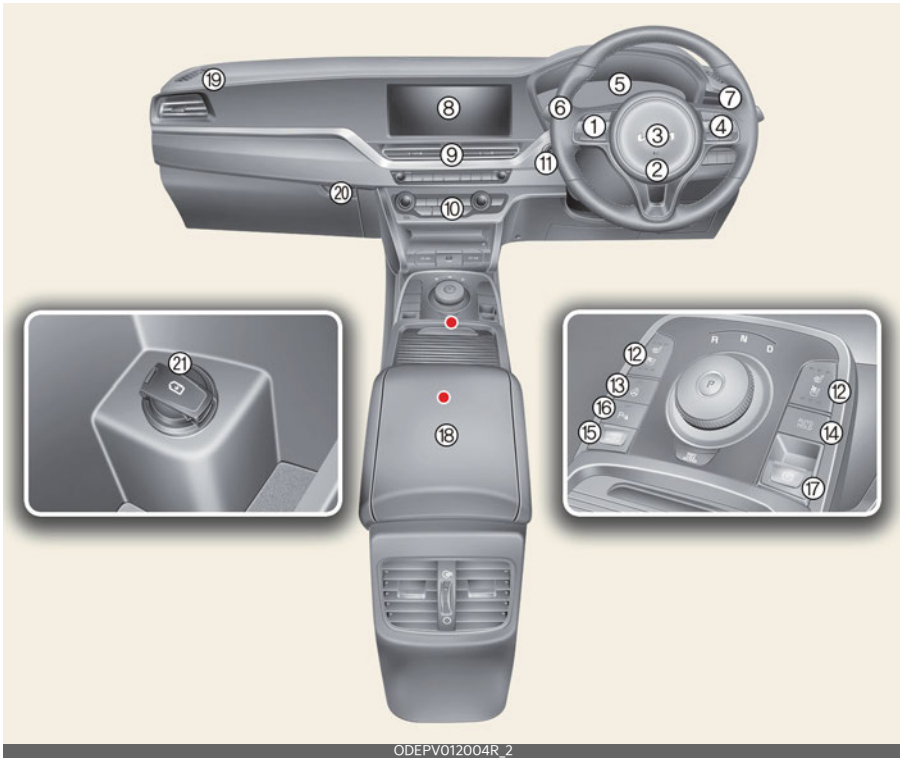

ODEPV012004R_2

* The actual features in your vehicle may not necessarily be available due to the selected options or regions.

- | | |
|---|------------|
| 1. Audio remote control button | 5-73 |
| 2. Driver's front air bag | 4-34 |
| 3. Horn | 5-23 |
| 4. Driving Assist button | 6-70 |
| 5. Instrument cluster | 5-28 |
| 6. Light control/turn signals lever, Wiper and washer control lever | 5-43, 5-48 |
| 7. Wiper and washer control lever, Light control/turn signals lever | 5-43, 5-48 |
| 8. Infotainment system | 5-73 |
| 9. Hazard warning flasher switch | 7-2 |
| 10. Climate control system | 5-55 |
| 11. START/STOP button | 6-8 |
| 12. Front seat warmer and air ventilation seat button | 5-67 |
| 13. Steering wheel heater button | 5-23 |

14.AUTO HOLD button	6-26
15.Drive mode button	6-31
16.Parking Safety button	6-95, 6-98
17.EPB switch	6-23
18.Center console storage box	5-64
19.Passenger's front air bag	4-34
20.Glove box	5-64
21.USB charger	5-69

Motor room compartment

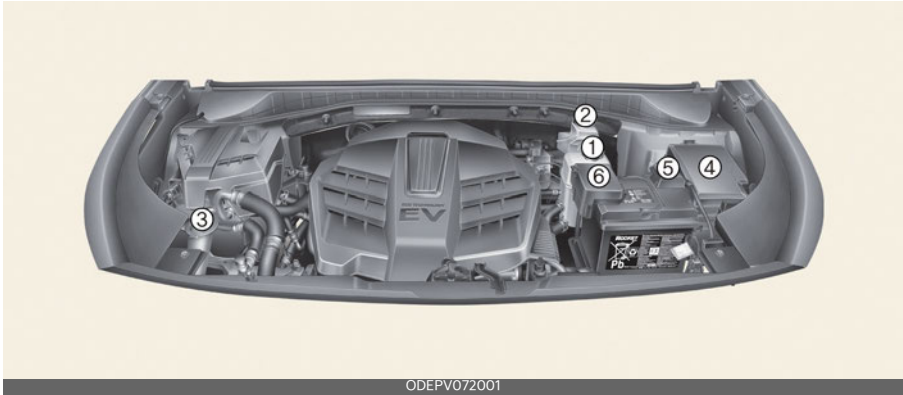

ODEPV072001

* The actual motor compartment in the vehicle may differ from the illustration.

- | | |
|--------------------------------------|-----------|
| 1. Coolant reservoir | 8-8 |
| 2. Brake fluid reservoir | 8-8 |
| 3. Windshield washer fluid reservoir | 8-9 |
| 4. Fuse box | 8-22 |
| 5. Negative battery terminal (-) | 7-3, 8-13 |
| 6. Positive battery terminal (+) | 7-3, 8-13 |

Seat	4-3
• Feature of seat leather	4-4
• Adjusting the front seat.....	4-4
• Passenger walk-in switch.....	4-5
• Seatback pocket.....	4-5
• Adjusting the rear seat	4-7
Headrest	4-9
• Adjusting the headrest	4-9
• Adjusting the headrest forward and backward (for front seats)	4-9
• Removing/reinstalling the headrest	4-9
Seat belts	4-11
• Seat belt restraint system.....	4-12
• Seat belt precautions.....	4-17
• Care of seat belts	4-19
Child restraint system (CRS)	4-20
• Our recommendation: Children always in the rear	4-20
• Selecting a Child Restraint System (CRS)	4-20
• Installing a Child Restraint System (CRS).....	4-22
ISOFIX anchorage and top-tether anchorage (ISOFIX Anchorage System) for children	4-22
• Securing a Child Restraint System with the "ISOFIX Anchorage" system	4-23
• Securing a Child Restraint System with the "Top-tether Anchorage" system	4-23
• Securing a Child Restraint System with a lap/shoulder belt.....	4-24
• Suitability of each seating position for belted & ISOFIX Child Restraint Systems (CRS) according to UN regulations (Information for use by vehicle users and CRS manufacturers)	4-25
Air bag - supplemental restraint system	4-26
• Air bag warning and indicator light	4-29
• Passenger's front air bag ON/OFF switch	4-29

4 Safety features of your vehicle

- SRS components and functions4-32
- Driver's and passenger's front air bags4-34
- Side air bag.....4-36
- Curtain air bag4-37
- Air bag collision sensors4-38
- Air bag inflation conditions.....4-39
- Air bag non-inflation conditions4-40
- SRS care 4-41
- Additional safety precautions.....4-42
- Adding equipment to or modifying your air bag-equipped vehicle.....4-43
- Air bag warning labels.....4-43

Safety features of your vehicle

Seat

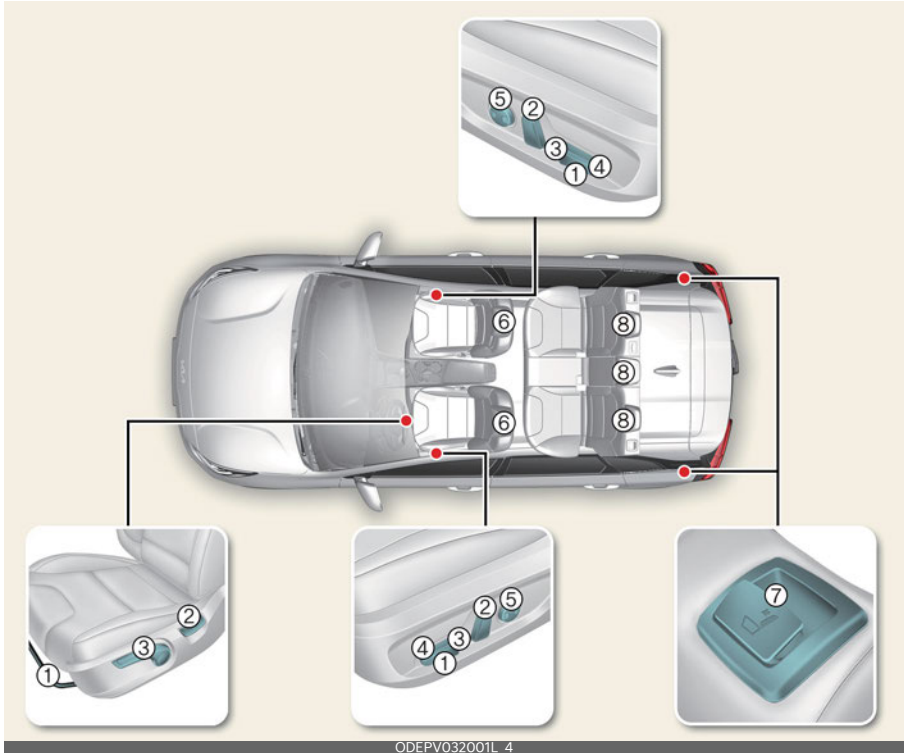

ODEPV032001L_4

* The actual features in your vehicle may not necessarily be available due to the selected options or regions.

* The picture above is based on LHD vehicle. For RHD vehicle, the operation of front seat are located on the opposite side.

Front seat

- 1 Forward and backward
- 2 Seatback angle
- 3 Seat cushion height
- 4 Seat cushion tilt
- 5 Lumbar support
- 6 Headrest

2nd-row seat

- 7 Seatback folding
- 8 Headrest

Feature of seat leather (if equipped)

- Our car seats are upholstered with a combination of artificial and genuine leather. The genuine leather is made from the outer skin of an animal, which goes through a special process to be available for use. Since it is a natural substance, each part differs in thickness or density. Also, wrinkles could appear depending on the temperature and humidity.
- The seat cover is made of stretchable material to improve comfort of passengers.
- The parts contacting the body are curved and the side supporting area is high which provides driving comfort and stability.
- Wrinkles may appear naturally from usage. It is not a fault of the product.

⚠ CAUTION

- Wrinkles or abrasions which appear naturally from usage are not covered by warranty.
- Belts with metallic accessories, zippers or keys inside the back pocket may damage the seat fabric.
- Make sure not to wet the seat. It may change the leather.
- Jeans or clothes which could bleach may contaminate the surface of the seat covering fabric.

Adjusting the front seat

Operation

- The seat can be adjusted using the control levers located on the outside of the seat cushion.

*** INFORMATION**

Adjust the seat before driving, and make sure the seat is locked securely by trying to move without using the lever. If the seat moves, it is not locked properly.

Manual seat



ODEPV032003

- 1 Forward/backward
- 2 Seatback angle
- 3 Cushion height

Power seat (if equipped)



- 1 Forward/backward
- 2 Seatback angle
- 3 Cushion height
- 4 Cushion tilt

Lumbar support (if equipped)



- 1 Increase support
- 2 Decrease support

* NOTICE

Do not continue to operate the lumbar support when the lumbar support provides its maximum support. Damage to the lumbar support motor could occur.

Passenger walk-in switch (if equipped)

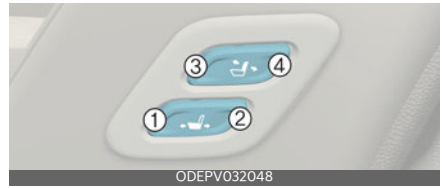

Operation

- To move the front passenger seat forward, press the switch (1). To move the front passenger seat rearward, press the switch (2).
- To recline the front passenger seat forward, press the switch (3). To recline the front passenger seat rearward, press the switch (4).

Seatback pocket (if equipped)



⚠ WARNING

- Loose objects in the driver's foot area could interfere with the operation of the foot pedals, possibly causing an accident.
- When you return the seatback to its upright position, hold the seatback and return it slowly and be sure there are no other occupants around the seat. If the seatback is returned without being held and controlled, the back of the seat could spring forward resulting in accidental injury to a person struck by the seatback.

- Riding in a vehicle with the seatback reclined could lead to serious or fatal injury in an accident.
- If a seat is reclined during an accident, the occupant's hips may slide under the lap portion of the seatbelt, applying great force to the unprotected abdomen. Serious or fatal internal injuries could result. The driver must advise the passenger to keep the seatback in an upright position whenever the vehicle is in motion.
- Do not use a sitting cushion that reduces friction between the seat and passenger. The passenger's hips may slide under the lap portion of the seat belt during an accident or a sudden stop. Serious or fatal internal injuries could result because the seat belt can't operate normally.
- Never attempt to adjust any seat while the vehicle is moving. This could result in loss of control, and an accident causing death, serious injury, or property damage.
- Do not allow anything to interfere with the normal position of the seatback. Storing items against a seatback or in any other way interfering with proper locking of a seatback could result in serious or fatal injury in a sudden stop or collision.
- Always drive and ride with your seatback upright and the lap portion of the seat belt snug and low across the hips. This is the best position to protect you in case of an accident.
- In order to avoid unnecessary and perhaps severe air bag injuries, always sit as far back as possible from the steering wheel while maintaining comfortable control of the vehicle. We recommend that your chest is at least 250 mm (10 inches) away from the steering wheel.
- The rear seatback must be securely latched. If not, passengers and objects could be thrown forward resulting in serious injury or death in the event of a sudden stop or collision.
- Luggage and other cargo should be laid flat in the cargo area. If objects are large, heavy, or must be piled, they must be secured. Under no circumstances should cargo be piled higher than the seatbacks. Failure to follow these warnings could result in serious injury or death in the event of a sudden stop, collision or rollover.
- No passenger should ride in the cargo area or sit or lie on folded seatbacks while the vehicle is moving. All passengers must be properly seated in seats and restrained properly while riding.
- When resetting the seatback to the upright position, make sure it is securely latched by pushing it forward and backwards.
- After adjusting the seat, always check that it is securely locked into place by attempting to move the seat forward or backward without using the lock release lever. Sudden or unexpected movement of the driver's seat could cause you to lose control of the vehicle resulting in an accident.
- Do not adjust the seat while wearing seat belts. Moving the seat cushion forward may cause strong pressure on the abdomen.
- Use extreme caution so that hands or other objects are not caught in the seat mechanisms while the seat is moving.

- Do not put a cigarette lighter on the floor or seat. When you operate the seat, gas may gush out of the lighter and cause fire.
- If there are occupants in the rear seats, be careful while adjusting the front seat position.
- Use extreme caution when picking small objects trapped under the seats or between the seat and the center console. Your hands might be cut or injured by the sharp edges of the seat mechanism.
- The power seat is operable with the START/STOP button in OFF position. Therefore, children should never be left unattended in the car.
- Do not put heavy or sharp objects in the seatback pockets. In an accident they could come loose from the pocket and injure vehicle occupants.

⚠ CAUTION

- The power seat is driven by an electric motor. Stop operating once the adjustment is completed. Excessive operation may damage the electrical equipment.
- When in operation, the power seat consumes a large amount of electrical power. To prevent unnecessary charging system drain, don't adjust the power seat longer than necessary while the vehicle is not running.
- Do not operate two or more power seat control switches at the same time. Doing so may result in power seat motor or electrical component malfunction.
- Do not store small or heavy objects. It might fly off and cause injuries.

Adjusting the rear seat

Folding rear seatback



Operation

1. Lower the rear headrests to the lowest position.
2. Pull on the seatback folding lever, then fold the seat toward the front of the vehicle.

Unfolding rear seatback

1. While pulling on the seatback folding lever, lift and pull the seatback backward. Pull the seatback firmly until it clicks into place.
2. Return the rear seat belt to the proper position
3. If you want to tilt the rear seatback a bit more, while pulling on the seatback folding lever and push the top of the rear seatback towards the rear. (if equipped)

⚠ WARNING

- Never attempt to adjust while the vehicle is moving or the rear seat is occupied as the seat may suddenly move and cause the passenger on the seat to be injured.
- The purpose of the fold-down rear seatbacks is to allow you to carry longer objects that could not be accommodated in the cargo area. Never allow passengers to sit on top of the folded down seatback while the vehicle is moving. This is not a proper

seating position and no seat belts are available for use. This could result in serious injury or death in case of an accident or sudden stop. Objects carried on the folded down seatback should not extend higher than the top of the front seatbacks. This could allow cargo to slide forward and cause injury or damage during sudden stops.

- Do not fold the rear seats if passengers, pets or luggage are in the rear seats. It may cause injury or damage to passengers, pets or luggage.
 - When you return the seatback to its upright position, hold the seatback and return it slowly. If the seatback is returned without holding it, the back of the seat could spring forward resulting in injury caused by being struck by the seatback.
 - Cargo should always be secured to prevent it from being thrown about the vehicle in a collision and causing injury to the vehicle occupants. Do not place objects in the rear seats, since they cannot be properly secured and may hit the front seat occupants in a collision.
 - Make sure the vehicle is off, the gear is in P (Park), and the parking brake is securely applied whenever loading or unloading cargo. Failure to take these steps may allow the vehicle to move if the shift dial is inadvertently moved to another position.
 - Never attempt to adjust while the vehicle is moving or the rear seat is occupied as the seat may suddenly move and cause the passenger on the seat to be injured.
- Do not allow your hands or fingers to get caught in the seat mechanisms while adjusting the seats.
 - When returning the rear seatbacks to the upright position, remember to return the rear shoulder belts to their proper position. Routing the seat belt webbing through the rear seat belt guides will help keep the belts from being trapped behind or under the seats.
 - When you fold the rear seatback, insert the buckle in the pocket between the rear seatback and cushion. Doing so can prevent the buckle from being damaged by the rear seatback.

⚠ CAUTION

Avoid excessive force when unfolding rear seat back.

Headrest

The seats are equipped with a headrest for the occupant's safety and comfort.

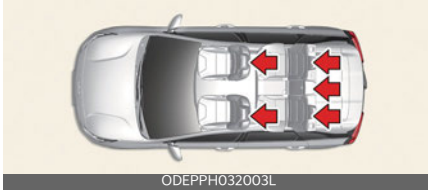

Adjusting the headrest forward and backward (for front seats) (if equipped)



Adjusting the headrest

Front

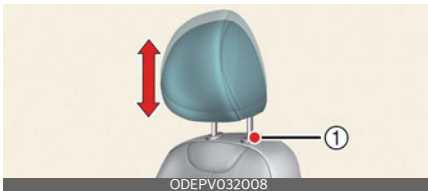

Rear

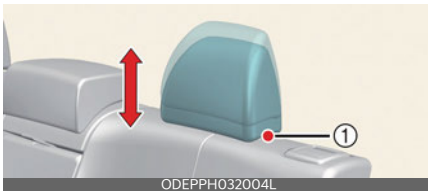

Operation

- Pull the headrest fully forward and release it.

Removing/reinstalling the headrest

Front

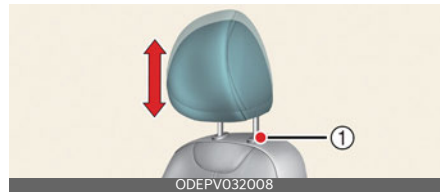

Rear

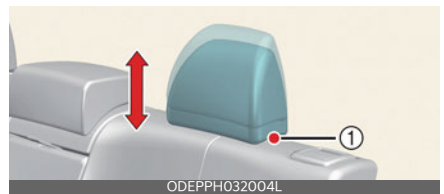

Operation

- Pull up the headrest to raise it.
- Push and hold the release button (1) to lower the headrest.

Operation

- Push and hold the release button (1) while pulling the headrest up.
- Do it in reverse order to reinstall the headrest.

⚠ WARNING

- For maximum effectiveness in case of an accident, the headrest should be adjusted so the middle of the headrest is at the same height of the center of gravity of an occupant's head. Generally, the center of gravity of most people's head is similar with the height of the top of their eyes. Also, adjust the headrest as close to your head as possible. For this reason, the use of a cushion that holds the body away from the seatback is not recommended.



⚠ CAUTION

- When there is no occupant in the rear seats, adjust the height of the headrest to the lowest position. The rear seat headrest can reduce the visibility of the rear area.
- If you recline the seatback towards the front with the headrest and seat cushion raised, the headrest may come in contact with the sun visor or other parts of the vehicle.



- Do not operate the vehicle with the headrests removed or reversed as severe injury to the occupants may occur in the event of an accident. Headrests may provide protection against neck injuries when properly adjusted.
- Do not adjust the headrest position of the driver's seat while the vehicle is in motion.
- Make sure the headrest locks in position after adjusting it to properly protect the occupants.
- Never allow anyone to ride in a seat with the headrests removed.
- Always make sure the headrest locks into position after reinstalling and adjusting it properly.

Seat belts

Seat belts are designed to bear upon the bony structure of the body, and should be worn low across the front of the pelvis, chest and shoulders.

WARNING

- For maximum restraint system protection, the seat belts must always be used whenever the car is moving.
 - Seat belts are most effective when seatbacks are in the upright position.
 - Children age 13 and younger must always be properly restrained in the rear seat. Never allow children to ride in the front passenger seat. If a child over 13 must be seated in the front seat, he/she must be properly belted and the seat should be moved as far back as possible.
 - Never wear the shoulder belt under your arm or behind your back. An improperly positioned shoulder belt can cause serious injuries in a crash. The shoulder belt should be positioned midway over your shoulder across your collarbone.
 - Never wear a seat belt over fragile objects. If there is a sudden stop or impact, the seat belt can damage it.
 - Avoid wearing twisted seat belts. A twisted belt can't do its job as well. In a collision, it could even cut into you. Be sure the belt webbing is straight and not twisted.
 - Be careful not to damage the belt webbing or hardware. If the belt webbing or hardware is damaged, replace it.
 - Seat belts are designed to bear upon the bony structure of the body, and should be worn low across the front of the pelvis or the pelvis, chest and shoulders, as applicable; wearing the lap section of the belt across the abdominal area must be avoided. Seat belts should be adjusted as firmly as possible, consistent with comfort, to provide the protection for which they have been designed.
- A slack belt will greatly reduce the protection afforded to the wearer. Care should be taken to avoid contamination of the webbing with polishes, oils and chemicals, and particularly battery acid. Cleaning may safely be carried out using mild soap and water. The belt should be replaced if webbing becomes frayed, contaminated or damaged. It is essential to replace the entire assembly after it has been worn in a severe impact even if damage to the assembly is not obvious. Belts should not be worn with straps twisted. Each belt assembly must only be used by one occupant; it is dangerous to put a belt around a child being carried on the occupant's lap.
- No modifications or additions should be made by the user which will either prevent the seat belt adjusting devices from operating to remove slack, or prevent the seat belt assembly from being adjusted to remove slack.
 - When you fasten the seat belt, be careful not to latch the seat belt in buckles of other seat. It's very dangerous and you may not be protected by the seat belt properly.
 - Do not unfasten the seat belt and do not fasten and unfasten the seat belt repeatedly while driving. This could result in loss of control, and an accident causing death, serious injury, or property damage.

- When fastening the seat belt, make sure that the seat belt does not pass over objects that are hard or can break easily.
- Make sure there is nothing in the buckle. The seat belt may not be fastened securely.

Seat belt restraint system

Seat belt warning light

Front seat belt warning light

Driver's seat

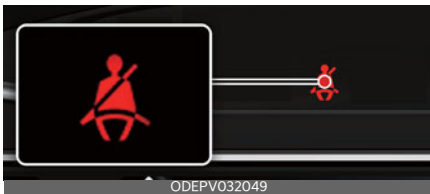

Passenger's seat



Operating condition(s)

- When the vehicle is running
 - The front seat belt warning light will appear for approximately 3~6 seconds.
- When the front seat belt is unfastened
 - For driver's seat, the front seat belt warning chime will sound for approximately 5 seconds. (if equipped)
 - The front seat belt warning light will stay appear. (if equipped)

- When the front seat belt is unfastened during driving and the vehicle speed is under approximately 20 km/h (12 mph)
 - The front seat belt warning light will appear
- When the vehicle speed is over approximately 20 km/h (12 mph)
 - The warning chime will sound for approximately 100 seconds
 - The front seat belt warning light will blink.

Rear passenger seat belt warning lights (if equipped)



- 1 Driver's side
- 2 Center
- 3 Passenger's side

Operating condition(s)

- When the vehicle is running
 - Rear passenger's seat belt warning light will appear for approximately 6 seconds.
- When the seat belt is unfastened during driving and the vehicle speed is under approximately 20 km/h (12 mph)
 - Rear passenger's seat belt warning light will blink for approximately 70 seconds.
- When the vehicle speed is over approximately 20 km/h (12 mph)

- Rear passenger's seat belt warning chime will sound for approximately 35 seconds
- Rear passenger's seat belt warning light will blink.

Non-operating condition(s)

- When the rear door is opened or closed, and the vehicle speed is under 10 km/h (6 mph)
 - Seat belt warning light and the seat belt warning chime will not work even if the vehicle speed is over approximately 20 km/h (12 mph).

⚠ WARNING

Riding in an improper position adversely affects the front seat belt warning system. It is important for the driver to instruct the passenger to properly be seated as instructed in this manual.

*** NOTICE**

- Although the front passenger seat is not occupied, the seat belt warning light will blink or appear for 6 seconds.
- The front passenger's seat belt warning may operate when luggage is placed.

Fastening and releasing the seat belt

3-point system with emergency locking retractor

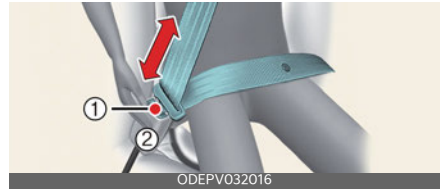

Operation

- To fasten the seat belt, insert the metal tab into the buckle (2).
- To release the seat belt, press the release button (1) in the locking buckle.

*** INFORMATION**

There will be an audible "click" when the tab locks into the buckle.



- 1 Rear right seat belt fastening buckle
- 2 Rear center seat belt fastening buckle (with the "CENTER" mark)
- 3 Rear left seat belt fastening buckle

⚠ WARNING

- You should place the lap belt portion as low as possible and snugly across your hips, not on your waist. If the lap belt is located too high on your waist, it may increase the chance of injury in the event of a collision. Both arms should not be under or over the belt.

Rather, one should be over and the other under, as shown in the illustration. Never wear the seat belt under the arm near the door.

- Prior to fastening the rear seat belts, ensure the latch matches the seat belt buckle. Forcefully fastening the left or right seat belt to the center buckle can result in an improper fastening scenario that will not protect you in an accident.

⚠ CAUTION

Do NOT fold down the left portion of the rear seatback when the rear center seat belt is buckled. ALWAYS UNBUCKLE the rear center seat belt before folding down the left portion of the rear seatback. If the rear center seat belt is buckled when the left portion of the rear seatback is folded down, distortion and damage to the top portion of the seatback and seat belt garnish may result, causing the seatback to lock into the folded down position.

*** NOTICE**

- The belt should be placed as low as possible on your hips, not on your waist. If the belt is too high, it could increase the possibility of you being injured in an accident.
- When using the rear center seat belt, the buckle with the "CENTER" mark must be used.

Adjusting height of the shoulder belt

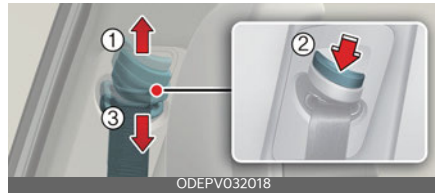

Operation

- Pull the height adjuster up (1).
- Press the height adjuster button (2) and push the height adjuster down (3).

⚠ WARNING

- After a collision, the seat belt system should be inspected to ensure it is operating normally. Replace any belts that are not functioning appropriately.
- Verify the shoulder belt anchor is locked into position at the appropriate height. Never position the shoulder belt across your neck or face.

⚠ CAUTION

- Do not force to lock the left or right seat belt into the center seat belt buckle. Make sure to lock the rear center seat belt into the center seat belt buckle. If not, the improperly fastened seat belt will not be able to provide protection.
- When pulling out to wear the seat belt, the tongue should be slowly pulled out of the seat belt guide so that the seat belt guide does not come off the trim.

* NOTICE

If you are not able to pull out the seat belt from the retractor, firmly pull the belt out and release it. Then you will be able to pull the belt out smoothly.

Pre-tensioner seat belt

Your vehicle is equipped with front driver and passenger, and rear passengers' seat belt pre-tensioners.

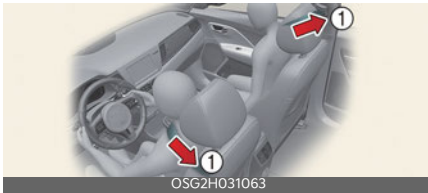

Your vehicle is equipped with driver's and front passenger's pre-tensioner seat belts.

The purpose of the pre-tensioner is to make sure that the seat belts fit tightly against the occupant's body in certain collisions.

The pre-tensioner seat belts may be activated in crashes where the collision is severe enough.

When the vehicle stops suddenly, or if the occupant tries to lean forward too quickly, the seat belt retractor will lock into position. In certain frontal collisions, the pre-tensioner will activate and pull the seat belt into tighter contact against the occupant's body.

1 Retractor pre-tensioner

The purpose of the retractor pre-tensioner is to make sure that the shoulder belts fit in tightly against the occupant's upper body in certain frontal collisions.

If the system senses excessive tension on the driver or passenger's seat belt when the pre-tensioner system activates, the load limiter inside the retractor pre-tensioner will release some of the pressure on the affected seat belt.

The seat belt pre-tensioner system consists mainly of the following components. Their locations are shown in the illustration:

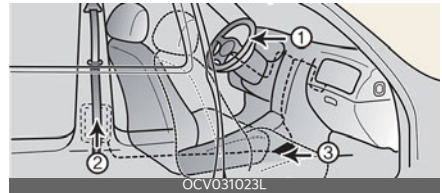

- 1 SRS air bag warning light
- 2 Front retractor pre-tensioner assembly
- 3 SRS control module

Operating condition(s)

- When the vehicle stops suddenly, or if the occupant tries to lean forward too quickly, the seat belt retractor will lock into position.
- In certain frontal collisions, the pre-tensioner will activate and pull the seat belt into tighter contact against the occupant's body.
- When the system senses excessive tension on the driver or passenger's seat belt when the pre-tensioner system activates, the load limiter inside the retractor pre-tensioner will release some of the pressure on the affected seat belt.

⚠ WARNING

- For your safety, be sure that the belt webbing is not loose or twisted and always sit properly on your seat.
- To obtain maximum benefit from a Seat belt pre-tensioner:
 1. The seatbelt must be working correctly and adjusted to the proper position. Please read and follow all of the important information and precautions about your vehicle's occupant safety features - including seat belts and air bags - that are provided in this manual.
 2. Be sure you and your passengers always wear seat belts properly.
- Pre-tensioner seat belts systems are designed to operate only one time. After activation, Seat belt pre-tensioners must be replaced. All seat belts of any type should always be replaced after they have been worn during a collision.
- The Seat belt pre-tensioner assembly mechanisms become hot during activation. Do not touch the seat belt pre-tensioner assemblies for several minutes after they have been activated.
- Do not attempt to inspect or replace the seat belt pre-tensioners yourself. Have the system inspected by a professional workshop. Kia recommends visiting an authorized Kia dealer/service partner.
- Do not attempt to service or repair the seat belt pre-tensioner system in any manner.
- Improper handling of the seat belt pre-tensioner assemblies, and failure to heed the warnings not to strike, modify, inspect, replace, service or repair the seat belt pre-tensioner

assemblies may lead to improper operation or inadvertent activation and serious injury.

- Always wear the seat belts when driving or riding in a motor vehicle.
- If the vehicle or seat belt pre-tensioner must be discarded, contact a professional workshop. Kia recommends visiting an authorized Kia dealer/service partner.
- Body work on the front area of the vehicle may damage the seat belt pre-tensioner system. Therefore, have the system serviced by a professional workshop. Kia recommends to visit an authorized Kia dealer/service partner.

⚠ CAUTION

If the seat belt pre-tensioner is not working properly, the SRS air bag warning light will appear even if there is no malfunction of the SRS air bag. If the SRS air bag warning light does not appear when the vehicle is in ON position, or if it remains illuminated after illuminating for approximately 3~6 seconds, or if it illuminates while the vehicle is being driven, have the system inspected by a professional workshop. Kia recommends visiting an authorized Kia dealer/service partner.

*** NOTICE**

- The pre-tensioner will activate not only in a frontal collision but also in a side collision, if the vehicle is equipped with a side or curtain air bag.
- When the seat belt pre-tensioners are activated, a loud noise may be heard and fine dust, which may appear to be smoke, may be visible in the passen-

ger compartment. These are normal operating conditions and are not hazardous.

- Although it is harmless, the fine dust may cause skin irritation and should not be breathed for prolonged periods. Wash all exposed skin areas thoroughly after an accident in which the seat belt pre-tensioners were activated.
- Because the sensor that activates the SRS air bag is connected with the seat belt pre-tensioner, the SRS air bag warning light on the instrument cluster will appear for approximately 3–6 seconds after the START/STOP button has been turned to the "ON" position, and then it should turn off.

Seat belt precautions

WARNING

All occupants of the vehicle must wear their seat belts at all times. Seat belts and child restraints reduce the risk of serious or fatal injuries for all occupants in the event of a collision or sudden stop. Without a seat belt, occupants could be shifted too close to a deploying air bag, strike the interior structure or be thrown from the vehicle. Properly worn seat belts greatly reduce these hazards. Always follow the precautions about seat belts, air bags and occupant seat contained in this manual.

Infant or small child

You should be aware of the specific requirements in your country. Child and/or infant seats must be properly placed and installed in the rear seat.

Refer to "Child restraint system (CRS)" on page 4-20.

WARNING

Every person in your vehicle needs to be properly restrained at all times, including infants and children. Never hold a child in your arms or lap when riding in a vehicle. The violent forces created during a crash will tear the child from your arms and throw the child against the interior. Always use a child restraint appropriate for your child's height and weight.

NOTICE

Small children are best protected from injury in an accident when properly restrained in the rear seat by a child restraint system that meets the requirements of the Safety Standards of your country. Before buying any child restraint system, make sure that it has label certifying that it meets Safety Standards of your country. The restraint must be appropriate for your child's height and weight. Check the label on the child restraint for this information. Refer to "Child restraint system (CRS)" on page 4-20.

Larger children

Children who are too large for child restraint systems should always occupy the rear seat and use the available lap/shoulder belts. The lap portion should be fastened in such a way that it is snug on the hips and as low as possible. Periodically check whether the belt is properly fastened. A child's squirming could put the belt out of position. In the event of an accident, children are afforded the most safety when they are restrained by a proper restraint system in the rear seat. If a larger child (over age 13) must be seated in the front seat, the child should be securely restrained by the available lap/shoulder belt and the seat should be placed in the rearmost position. Children aged 13 and under should be restrained securely in the rear seat. NEVER place a child aged 13 or under in the front seat. NEVER place a rear facing child seat in the front seat of a vehicle. If the shoulder belt portion slightly touches the child's neck or face, try placing the child closer to the center of the vehicle. If the shoulder belt still touches their face or neck they need to be returned to a child restraint system.

WARNING

- Never allow a shoulder belt to be in contact with a child's neck or face while the vehicle is in motion.
- If seat belts are not properly worn and adjusted on children, there is a risk of death or serious injury.

Pregnant women

The use of a seat belt is recommended for pregnant women to lessen the chance of injury in an accident. When a seat belt is used, the lap belt portion should be placed as low and as snugly as possible on the hips, not across the abdomen. For specific recommendations, consult a physician.

WARNING

Pregnant women must never place the lap portion of the safety belt over the area of the abdomen where the fetus is located or above the abdomen where the belt could crush the fetus during an impact.

Injured person

A seat belt should be used when an injured person is being transported. When this is necessary, you should consult a physician for recommendations.

One person per belt

Two people (including children) should never attempt to use a single seat belt. This could worsen the injuries in the event of an accident.

Do not lie down

To reduce the chance of injuries in the event of an accident and to achieve maximum effectiveness of the restraint system, all passengers should be sitting up and the front seats should be in an upright position when the car is moving. A seat belt cannot provide proper protection if the person is lying down in the rear seat or if the front seat is in a reclined position.

⚠ WARNING

Riding with a reclined seatback increases your chance of serious or fatal injuries in the event of a collision or sudden stop. The protection of your restraint system (seat belts and air bags) is greatly reduced by reclining your seat. Seat belts must be snug against your hips and chest to work properly. The more the seatback is reclined, the greater the chance that an occupant's hips will slide under the lap belt causing serious internal injuries or the occupant's neck could strike the shoulder belt. Drivers and passengers should always sit well back in their seats, properly belted, and with the seatbacks upright.

Care of seat belts

Seat belt systems should never be disassembled or modified. In addition, care should be taken to ensure that seat belts and belt hardware are not damaged by seat hinges, doors, or other abuse.

⚠ WARNING

- When you return the rear seatback to its upright position after the rear seatback was folded down, be careful not to damage the seat belt webbing or buckle. Be sure that the webbing or buckle does not get caught or pinched in the rear seat. A seat belt with damaged webbing or buckle will not be as strong and could possibly fail during a collision or sudden stop, resulting in serious injury. If the webbing or buckles are damaged, get them replaced immediately.

- Seat belts can become hot in a vehicle that has been closed up in sunny weather. They could burn infants and children.

Periodic inspection

It is recommended that all seat belts be inspected periodically for wear or damage of any kind. Any damaged parts should be replaced as soon as possible.

Keep belts clean and dry

If belts become dirty, they can be cleaned by using a mild soap solution and warm water. Bleach, dye, strong detergents, or abrasives should not be used since they may damage and weaken the fabric.

When to replace seat belts

The entire in-use seat belt assembly or assemblies should be replaced if the vehicle has been involved in an accident. This should be done even if no damage is visible. In such case, have the system replaced by a professional workshop. Kia recommends to consult an authorized Kia dealer/service partner.

Child restraint system (CRS)

Our recommendation: Children always in the rear

Infants and younger children must be restrained in an appropriate rearward-facing or forward-facing CRS that has first been properly secured to the seat of the vehicle. Read and comply with the instructions for installation and use provided by the manufacturer of the Child Restraint System.

Children under the age of 13 should always ride in the rear seats; they must always be restrained properly to minimize the risk of injury in case of accident, sudden stop, or sudden maneuver. According to accident statistics, children are safer when properly restrained in the rear seats than when they are in the front seat. Children too large for a Child Restraint System must use the seat belts provided.

Most countries have regulations requiring that children travel in approved child restraint systems.

Laws governing the age or height/weight restrictions at which seat belts can be used instead of Child Restraint System differ among countries, so you should be aware of the specific requirements in your country/the country where you are driving.

Child Restraint Systems must be properly installed in the vehicle seat. Always use a commercially available Child Restraint System that meets the requirements of your country.

WARNING

- Always properly restrain children in the vehicle. Children of all ages are safer when riding in the rear seats. Never place a rearward-facing Child Restraint System on the front passenger seat, unless the air bag is deactivated.
- Always follow the Child Restraint System manufacturer's instructions for installation and use.
- Always properly restrain your child in the Child Restraint System.
- Do not use an infant carrier or a child safety seat that "hooks" over a seat-back, it may not provide adequate protection in an accident.
- After an accident, have the system checked by a professional workshop. Kia recommends visiting an authorized Kia dealer/service partner.

Selecting a Child Restraint System (CRS)

Operation

- Select a Child Restraint System based on your child's height and weight. The required label or the instructions for use typically provide this information.
- Select a Child Restraint System that fits the vehicle seating position where it will be used.

INFORMATION

- Make sure the Child Restraint System has a label certifying that it meets the applicable Safety Standards of your country. A Child Restraint System may only be installed if it was approved in accordance with the requirements of

ECE-R44 or ECE-R129 or relevant regulation.

- Select a Child Restraint System based on your child's height and weight. The required label or the instructions for use typically provide this information.
- Select a Child Restraint System that fits the vehicle seating position where it will be used. For the suitability of Child Restraint Systems on the vehicle's seating positions, please refer to "Suitability of each seating position for belted & ISOFIX Child Restraint Systems (CRS) according to UN regulations (Information for use by vehicle users and CRS manufacturers)" on page 4-25.
- Read and comply with the warnings and instructions for installation and use provided with the Child Restraint System.

Child restraint system types

Forward/rearward-facing Child Restraint System



A rearward-facing Child Restraint System provides restraint with the seating surface against the back of the child. The harness system holds the child in place and, in an accident, keeps the child positioned in the child restraint system and reduces stress to the fragile neck and spinal cord.

All children under the age of one year must always ride in a rearward-facing

Child Restraint System. There are different types of rearward-facing child restraint system: infant-only child restraint systems can only be used facing rearward. Convertible and 3-in-1 Child Restraint Systems typically have higher height and weight limits for the rearward-facing position, allowing you to keep your child rearward-facing for a longer period of time.

Keep using child restraint systems in the rearward-facing position as long as the children are within the height and weight limits specified by the child restraint system's manufacturer.

A forward-facing Child Restraint System provides restraint for the child's body with a harness. Keep children in a forward-facing child restraint system with a harness until they reach the maximum height or weight limit allowed by your child restraint system's manufacturer.

Once your child outgrows the forward-facing Child Restraint System, your child is ready for a booster seat.

Booster seats

A booster seat is a Child Restraint System designed to improve the fit of the vehicle's seat belt system. A booster seat positions the seat belt so that it fits properly over the stronger parts of your child's body. Keep your children in booster seats until they are big enough to fit in a seat belt properly.

For a seat belt to fit properly, the lap belt must lie comfortably across the upper thighs, not the stomach. The shoulder belt should lie comfortably across the shoulder and chest and not across the neck or face. Children under the age of 13 should always ride in the rear seats; they must always be restrained properly

to minimize the risk of injury in case of accident, sudden stop, or sudden maneuver.

Installing a Child Restraint System (CRS)

Operation

1. Properly secure the Child Restraint System to the vehicle.
2. Make sure the Child Restraint System is firmly secured.
3. Secure the child in the Child Restraint System.

⚠ WARNING

- Before installing your Child Restraint System always: Read and follow the instructions provided by the manufacturer of the Child Restraint System. Failure to follow all warnings and instructions could increase the risk of the serious injury or death if an accident occurs.
- If the vehicle's headrest prevents proper installation of a Child Restraint System, the headrest of the respective seating position shall be readjusted or entirely removed.

⚠ CAUTION

A Child Restraint System in a closed vehicle can become very hot. To prevent burns, check the seating surface and buckles before placing your child in the Child Restraint System.

ISOFIX anchorage and top-tether anchorage (ISOFIX Anchorage System) for children

ISOFIX anchorages are metal bars built into the vehicle. There are two lower anchors for each ISOFIX seating position that will accommodate a Child Restraint System with lower attachments.



- 1 ISOFIX anchor position indicator
- 2 ISOFIX anchor

ISOFIX anchorages have been provided in the left and right outboard rear seating positions.

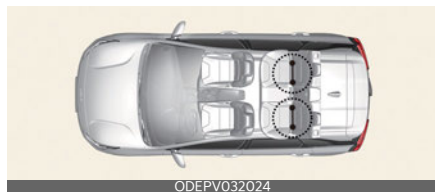

⚠ WARNING

Do not attempt to install a Child Restraint System using ISOFIX anchorages in the rear center seating position. There are no ISOFIX anchorages provided for this seat. Using the outboard seat anchorages, for the CRS installation

on the rear center seating position, can damage the anchorages.

Securing a Child Restraint System with the "ISOFIX Anchorage" system

When not using the ISOFIX system, all Child Restraint Systems must be secured to a rear seat with the lap part of a lap/shoulder belt.

Operation

1. Move the seat belt buckle away from the ISOFIX anchorages.
2. Move any other objects away from the anchorages.
3. Place the Child Restraint System on the vehicle seat, then attach the seat to the ISOFIX anchorages according to the instructions provided by the Child Restraint System manufacturer.
4. Follow the instructions of the Child Restraint System's manufacturer for proper installation and connection of the ISOFIX attachments on the Child Restraint System to the ISOFIX anchorages.

⚠ WARNING

Take the following precautions when using the ISOFIX system:

- Read and follow all installation instructions provided with your Child Restraint System.
- To prevent the child from reaching and taking hold of unretracted seat belts, buckle all unused rear seat belts and retract the seat belt webbing behind the child. Children can be strangled if a shoulder belt becomes wrapped around their neck and the seat belt tightens.

- NEVER attach more than one Child Restraint System to a single anchorage. This could cause the anchor or attachment to come loose or break.
- Always have the ISOFIX (i- Size) system inspected by your dealer after an accident. An accident can damage the ISOFIX system and may not properly secure the Child Restraint System.

Securing a Child Restraint System with the "Top-tether Anchorage" system

Type A



Type B

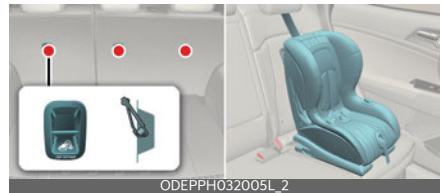

Operation

1. Route the Child Restraint System seat strap over the seatback.
2. Connect the top-tether to the top-tether anchorage.
3. Tighten the top-tether according to the instructions of your Child Restraint System's manufacturer.

⚠ WARNING

Take the following precautions when installing the top-tether:

- Read and follow all installation instructions provided with your Child Restraint System.
- NEVER attach more than one Child Restraint System to a single ISOFIX top-tether anchorage. This could cause the anchorage or attachment to come loose or break.
- Do not attach the top-tether to anything other than the correct top-tether anchorage. It may not work properly if attached to something else.
- Child restraint anchorages are designed to withstand only those loads imposed by correctly fitted child restraints. Under no circumstances are they to be used for adult seat belts, harnesses, or for attaching other items or equipment to the vehicle.

Securing a Child Restraint System with a lap/shoulder belt

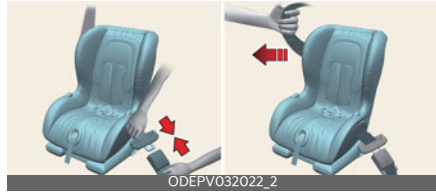

Operation

1. Place the Child Restraint System on a rear seat and route the lap/shoulder belt around or through the Child Restraint System.
2. Fasten the lap/shoulder belt latch into the buckle.
3. Remove as much slack from the belt as possible by pushing down on the Child Restraint System while feeding the shoulder belt back into the retractor.
4. Push and pull on the Child Restraint System to confirm that the seat belt is holding it firmly in place.
5. If your Child Restraint System manufacturer recommends the use of a top-tether with the lap/shoulder belt, see Securing a child restraint system seat with the "top-tether anchorage" system section in this chapter.
6. To remove the Child Restraint System, press the release button on the buckle, and then pull the lap/shoulder belt out of the Child Restraint System and allow the seat belt to retract fully.

Suitability of each seating position for belted & ISOFIX Child Restraint Systems (CRS) according to UN regulations (Information for use by vehicle users and CRS manufacturers)

- Yes: Suitable for fitment of the designated category of CRS
- No: Not suitable for fitment of the designated category of CRS
- "-": Not applicable
- The table is based on LHD vehicle. Except for the front passenger seat, the table is valid for RHD vehicle. For RHD vehicle front passenger seat, please use information for the seating position number 3.
- All type vehicle is allowed.

F: Forward facing

R: Rearward facing

CRS categories		Seating positions (Rear center 3-point belt type)					
		1	2	3	4	5	6
Universal belted CRS	All mass groups	-	-	Yes ¹ (F, R)	Yes (F, R)	Yes (F, R)	Yes (F, R)
i-size CRS	ISOFIX CRF: F2, F2X, R1, R2	-	-	No	Yes (F, R)	No	Yes (F, R)
Carry-cot (ISOFIX lateral facing CRS)	ISOFIX CRF: L1, L2	-	-	No	No	No	No
ISOFIX infant* CRS (*: ISOFIX baby CRS)	ISOFIX CRF: R1	-	-	No	Yes (R)	No	Yes (R)
ISOFIX toddler CRS - small	ISOFIX CRF: F2, F2X, R2, R2X	-	-	No	Yes (F, R)	No	Yes (F, R)
ISOFIX toddler CRS - large* (*: not booster seats)	ISOFIX CRF: F3, R3	-	-	No	Yes (F, R)	No	Yes (F, R)
Booster Seat - reduced width	ISO CRF: B2	-	-	No	Yes	No	Yes
Booster Seat - full width	ISO CRF: B3	-	-	No	Yes	No	Yes

* 1. For fitment of universal belted Child Restraint Systems on the seat number 3, Seat back angle should be at its fully forward position.

Seat Number	Position in the vehicle	Seating positions
1	Front left	
2	Front center	
3	Front right	
4	2nd row left	
5	2nd row center	
6	2nd row right	

* Never place a rearward facing Child Restraint System on the front passenger seat, unless the air bag is deactivated.

* For semi-universal or vehicle specific CRS (ISOFIX or belted CRS), please see the vehicle list provided in the manual of CRS.

Air bag - supplemental restraint system

Left-hand drive

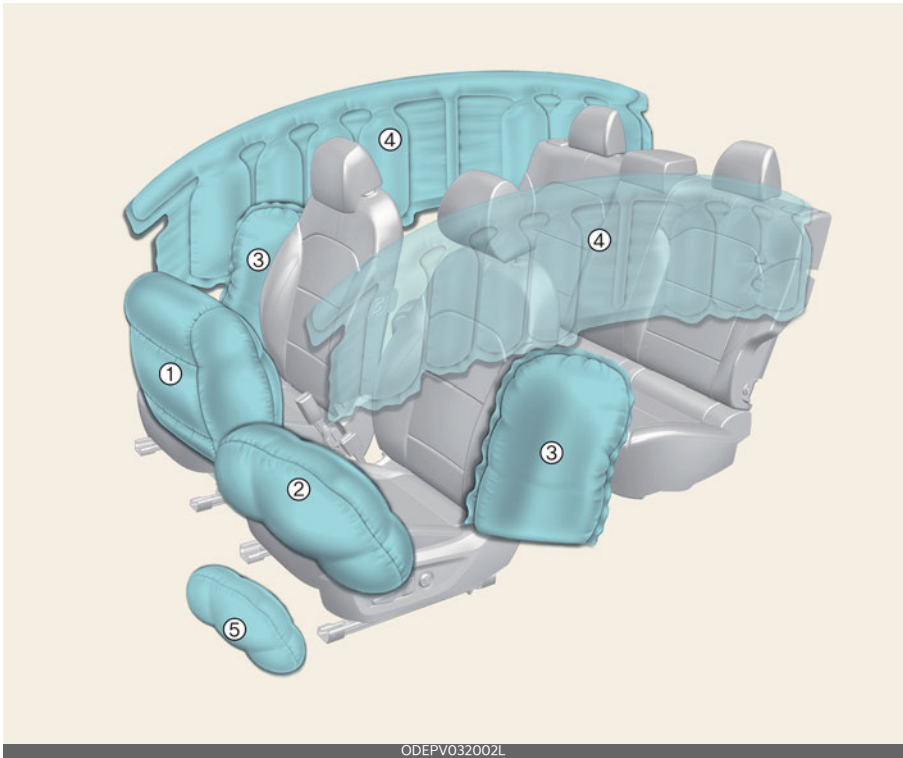

ODEPV032002L

* The actual features in your vehicle may not necessarily be available due to the selected options or regions.

- 1 Passenger's front air bag
- 2 Driver's front air bag
- 3 Side air bag
- 4 Curtain air bag
- 5 Driver's knee air bag

Right-hand drive

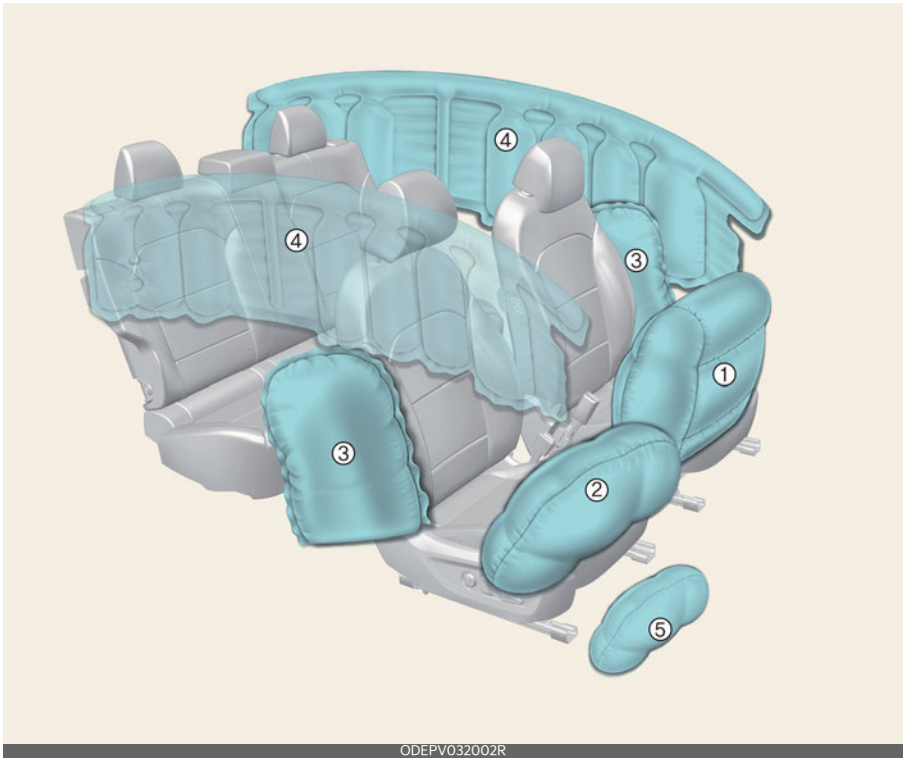

4

* The actual features in your vehicle may not necessarily be available due to the selected options or regions.

- 1 Passenger's front air bag
- 2 Driver's front air bag
- 3 Side air bag
- 4 Curtain air bag
- 5 Driver's knee air bag

How does the air bag system operate?

- Air bags are activated (able to inflate if necessary) only when the START/STOP button is in the ON position and it can be activated within about 3 minutes after the vehicle is in OFF position.
- Air bags inflate instantly in the event of serious frontal or side collision (if a side air bag or a curtain air bag is present) in order to help protect the occupants from serious physical injury.
- Generally, air bags are designed to inflate based upon the severity of a collision and its direction, etc. These two factors determine whether the sensors produce electronic deployment/inflation signal.
- Air bags will inflate based upon the severity of a collision and its direction, etc. Air bags will not inflate in every crash or collision situation.
- The front air bags will completely inflate and deflate in an instant. It is virtually impossible for you to see the air bags inflate during an accident. It is much more likely that you will simply see the deflated air bags hanging out of their storage compartments after the collision.
- In order to help provide protection in a severe collision, the air bags must inflate rapidly. The speed of air bag inflation is due to the extremely short time when a collision occurs and the need to get the air bag between the occupant and the vehicle structures before the occupant impacts those structures. This speed of inflation reduces the risk of serious or life-threatening injuries in a severe collision

and is thus a necessary part of air bag design.

- However, air bag inflation can also cause injuries, including facial abrasions, bruises, and broken bones, because the inflation speed also causes the air bags to expand with a great deal of force.
- There are even circumstances under which contact with the steering wheel air bag can cause fatal injuries, especially if the occupant is positioned excessively close to the steering wheel.

WARNING

- Even in vehicles with air bags, you and your passengers must always wear the safety belts provided in order to minimize the risk and severity of injury in the event of a collision or in most rollover situations.
- SRS and pre-tensioners contain explosive chemicals. If scraping a vehicle without removing SRS and pre-tensioners from a vehicle, it may cause fire. Before scraping a vehicle, contact a professional workshop. Kia recommends visiting an authorized Kia dealer/service partner.
- Keep the SRS parts and wirings away from water or any liquid. If the SRS components are inoperative due to exposure to water or liquids, it may cause fire or severe injury.
- To avoid severe personal injury or death caused by deploying air bags in a collision, the driver should sit as far back from the steering wheel air bag. The front passenger should always move their seat as far back as possible and sit back in their seat.

- Air bag inflates instantly in an event of a collision, passengers may be injured by the air bag expansion force if they are not in a proper position.
- Air bag inflation may cause injuries including facial or bodily abrasions, injuries from broken glasses or burns.

Noise and smoke

When the air bags inflate, they make a loud noise and leave smoke and powder in the air inside of the vehicle. This is normal and is a result of the ignition of the air bag inflator. After the air bag has inflated, you may feel substantial discomfort in breathing due to the contact between your chest and both the seat belt and the air bag, as well as from breathing the smoke and powder.

Open your doors and/or windows as soon as possible after an impact in order to reduce discomfort and prevent prolonged exposure to the smoke and powder.

Though the smoke and powder are non-toxic, they may cause skin irritation (eyes, nose, throat, etc.). If this is the case, wash and rinse with cold water immediately and consult the doctor if the symptom persists.

⚠ WARNING

- When the air bags deploy, the air bag related parts in the steering wheel and/or instrument cluster and/or in both sides of the roof rails above the front and rear doors are very hot. To prevent injury, do not touch the air bag storage areas internal components immediately after an air bag has inflated.

- Do not install or place any accessories near air bag deployment areas, such as the instrument cluster, windows, pillars, and roof rails.

Air bag warning and indicator light

Air bag warning light

Operating condition(s)

- When the vehicle is running
 - The air bag warning light should appear for approximately 3~6 seconds and go off.

Malfunction

- The air bag warning light does not turn on briefly when the vehicle is running.
- The air bag warning light stays on after illuminating for approximately 3~6 seconds.
- The air bag warning light comes on while the vehicle is moving.

Passenger's front air bag ON/OFF switch (if equipped)

The passenger's front air bag can be deactivated by the passenger's front air bag ON/OFF switch if a child restraint is installed on the front passenger's seat or if the front passenger's seat is unoccupied by a person.





ODEPPH032008L_2

Operation

- Insert the mechanical key into the passenger's front air bag ON/OFF switch.
- Turn the key to activate/deactivate passenger's front air bag.
 - When the child restraint is installed on the front passenger's seat.
 - When the seat is unoccupied.

* INFORMATION

To ensure the safety of your child, the passenger's front air bag must be deactivated when it should be necessary to install a rearward facing child seat on the front passenger seat in exceptional circumstances.

Front passenger air bag ON/OFF indicator (if equipped)



ODEPPH032008L_2

Operating condition(s)

- After the vehicle is running
 - The front passenger air bag ON/OFF indicator appears for approximately 4 seconds.

- When the passenger's front air bag ON/OFF switch is set to the ON/OFF position
 - The front passenger air bag ON/OFF indicator appears.

Non-operating condition(s)

- When the vehicle is running within approximately 3 minutes after the vehicle is turned off
 - The front air bag ON/OFF indicator will not appear.

WARNING

- The front air bag ON/OFF switch could turn by using a similar small rigid device. Always check the status of the front air bag ON/OFF switch and Front passenger air bag ON/OFF indicator.
- The driver is responsible for the proper position of the passenger's front air bag ON/OFF switch.
- Deactivate the passenger's front air bag only when the vehicle is in OFF position, or the malfunction may occur in the SRS Control Module. And there may be a danger that the driver's and/or front passenger's and/or side and curtain air bag may fail to trigger, or not trigger correctly during a collision.
- Never install a rearward facing child seat on the front passenger's seat unless the passenger's front air bag has been deactivated. The infant or child could be severely injured or killed by an air bag deployment in case of an accident.

- Even though your vehicle is equipped with the passenger's front air bag ON/OFF switch, do not install a child restraint system in the front passenger's seat. A child restraint system must never be placed in the front seat. Children who are too large for child restraint systems should always occupy the rear seat and use the available lap/shoulder belts. In the event of an accident, children are afforded the most safety when they are restrained by a proper restraint system in the rear seat.
- As soon as the child seat is no longer needed on the front passenger's seat, reactivate the front passenger's air bag.
- Never place or insert any object into any small opening near side airbag labels attached to the vehicle seats. When the air bag deploys, the object may affect the deployment and result in unexpected accident or bodily harm.
- No objects (such as crash pad cover, cellular phone holder, cup holder, perfume or stickers) should be placed over or near the air bag modules on the steering wheel, instrument cluster, windshield glass, and the front passenger's panel above the glove box. Such objects could cause harm if the vehicle is in a crash severe enough to cause the air bags to deploy. Do not place any objects over the air bag or between the air bag and yourself.

CAUTION

- If the passenger's front air bag ON/OFF switch is not working properly, the air bag warning light on the instrument panel will appear. And, the passenger's front air bag OFF indicator (OFF) will not appear (The passenger's front air bag ON indicator comes on), the SRS Control Module reactivate the passenger's front air bag and the passenger's front air bag will inflate in frontal impact crashes even if the passenger's front air bag ON/OFF switch is set to the OFF position (OFF). In this case, have the system inspected by a professional workshop. Kia recommends visiting an authorized Kia dealer/service partner.
- If the SRS air bag warning light blinks or does not appear when the vehicle is in ON position, or if it appears while the vehicle is being driven, have the system inspected by a professional workshop. Kia recommends visiting an authorized Kia dealer/service partner.

NOTICE

- When the passenger's front air bag ON/OFF switch is set to the ON position, the passenger's front air bag is activated and child or infant seat should not be installed on the front passenger's seat.
- When the passenger's front air bag ON/OFF switch is set to the OFF position, the passenger's front air bag is deactivated.

SRS components and functions

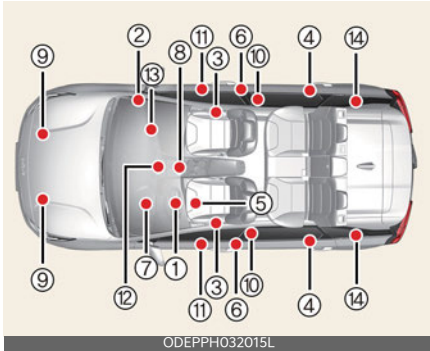

* The actual features in your vehicle may not necessarily be available due to the selected options or regions.

- 1 Driver's front air bag module
 - 2 Passenger's front air bag module
 - 3 Side air bag modules*
 - 4 Curtain air bag modules*
 - 5 Driver's knee air bag*
 - 6 Retractor pre-tensioner assemblies
 - 7 Air bag warning light
 - 8 SRS control module (SRSCM)/rollover sensor*
 - 9 Front impact sensors
 - 10 Side impact sensors*
 - 11 Side pressure sensors*
 - 12 Passenger's front air bag ON/OFF indicator (front passenger's seat only)*
 - 13 Passenger's front air bag ON/OFF switch*
 - 14 Retractor pre-tensioner assemblies*
- * : if equipped

Operating condition(s)

- START/STOP button is in ON position
 - The SRS air bag warning light will appear for approximately 6 seconds and go out.

⚠ WARNING

If any of the following conditions occurs, this indicates a malfunction of the SRS. In this case, have the system inspected by a professional workshop. Kia recommends visiting an authorized Kia dealer/service partner.

- The light does not turn on briefly when you turn the vehicle ON.
- The light stays on after illuminating for approximately 6 seconds.
- The light comes on while the vehicle is in motion.
- The light blinks when the vehicle is in ON position.

Driver's front air bag (1)



Driver's front air bag (2)



Driver's front air bag (3)



Passenger's front air bag



The air bag modules are located both in the center of the steering wheel and in the front passenger's panel above the glove box. When the SRSCM detects a sufficiently severe impact to the front of the vehicle, it will automatically deploy the front air bags.

Upon deployment, tear seams molded directly into the pad covers will separate under pressure from the expansion of the air bags. Further opening of the covers then allows full inflation of the air bags.

A fully inflated air bag, in combination with a properly worn seat belt, slows the driver's or the passenger's forward motion, reducing the risk of head and chest injury.

After complete inflation, the air bag immediately starts deflating, enabling the driver to maintain forward visibility and the ability to steer or operate other controls.

⚠ WARNING

- Do not install or place any accessories (drink holder, CD holder, sticker, etc.) on the front passenger's panel above the glove box in a vehicle with a passenger's air bag. Such objects may become dangerous projectiles and cause injury if the passenger's air bag inflates.
- When installing a container of liquid air freshener inside the vehicle, do not

place it near the instrument cluster nor on the instrument panel surface. It may become dangerous projectiles and cause injury if the passenger's air bag inflates.

- If an air bag deploys, there may be a loud noise followed by a fine dust released in the vehicle. These conditions are normal and are not hazardous - the air bags are packed in this fine powder. The dust generated during air bag deployment may cause skin or eye irritation as well as aggravate asthma for some persons. Always wash all exposed skin areas thoroughly with cold water and a mild soap after an accident in which the air bags were deployed.
- The SRS can function only when the START/STOP button is in the ON position and within approximately 3 minutes after the vehicle is in OFF position. If the SRS air bag warning light does not appear, or continuously remains on after illuminating for about 6 seconds when the START/STOP button is in ON position, or after the vehicle is started, comes on while driving, the SRS is not working properly. In this case, have the system inspected by a professional workshop. Kia recommends visiting an authorized Kia dealer/service partner.
- Before you replace a fuse or disconnect a battery terminal, press START/STOP button to OFF position. Never remove or replace the air bag related fuse(s) when the START/STOP button is in the ON position. Failure to heed this warning will cause the SRS air bag warning light to appear.

Driver's and passenger's front air bags

Driver's front air bag/Passenger's front air bag



Driver's knee air bag



The indications of the system's presence are the words **AIR BAG** intagliated on the air bag pad cover on the steering wheel, on the cover of the driver's side knee bolster located below the steering wheel, and the passenger's side front panel pad above the glove box.

⚠ WARNING

- The driver's hands should be placed on the steering wheel at the 9:00 and 3:00 positions. The passenger's arms and hands should be placed on their laps.
- Always use seat belts and child restraints - every trip, every time, everyone! Air bags inflate with considerable force and in the blink of an eye. Seat belts help keep occupants in proper position to obtain maximum benefit from the air bag. Even with air bags, improperly and unbelted occupants can be severely injured when the air bag inflates. Always follow the precautions about seat belts, air bags

and occupant safety contained in this manual.

- To reduce the chance of serious or fatal injuries and receive the maximum safety benefit from your restraint system:
 - Never place a child in any child or booster seat in the front seat.
 - ABC - Always Buckle Children in the back seat. It is the safest place for children of any age to ride.
 - Front and side air bags can injure occupants improperly positioned in the front seats.
 - Move your seat as far back as practical from the front air bags, while still maintaining control of the vehicle.
 - You and your passengers should never sit or lean unnecessarily close to the air bags. Improperly positioned drivers and passengers can be severely injured by inflating air bags.
 - Never lean against the door or center console - always sit in an upright position.
 - No objects should be placed over or near the air bag modules on the steering wheel, instrument panel, and the front passenger's panel above the glove box, because any such object could cause harm if the vehicle is in a crash severe enough to cause the air bags to deploy.
 - If the SRS air bag warning light remains appeared while the vehicle is being driven, have the system inspected by a professional workshop. Kia recommends visiting an authorized Kia dealer/service partner.

- Air bags can only be used once - have the system replaced by a professional workshop.
Kia recommends visiting an authorized Kia dealer/service partner.
- The SRS is designed to deploy the front air bags only when an impact is sufficiently severe. Additionally, the air bags will only deploy once. Seat belts must be worn at all times.
- Front air bags are not intended to deploy in side-impact, rear-impact or rollover crashes. In addition, front air bags will not deploy in frontal crashes below the deployment threshold.
- A child restraint system must never be placed in the front seat. The infant or child could be severely injured or killed by an air bag deployment in case of an accident.
- Children age 13 and under must always be properly restrained in the rear seat. Never allow children to ride in the front passenger seat. If a child over age 13 must be seated in the front seat, he or she must be properly belted and the seat should be moved as far back as possible.
- For maximum safety protection in all types of crashes, all occupants including the driver should always wear their seat belts whether or not an air bag is also provided at their seating position to minimize the risk of severe injury or death in the event of a crash. Do not sit or lean unnecessarily close to the air bag while the vehicle is in motion.
- Sitting improperly or out of position can result in serious or fatal injury in a crash. All occupants should sit upright with the seat back in an

upright position, center on the seat cushion with their seat belt on, legs comfortably extended and their feet on the floor until the vehicle is parked.

- The SRS air bag system must deploy very rapidly to provide protection in a crash. If an occupant is out of position because of not wearing a seat belt, the air bag may forcefully contact the occupant causing serious or fatal injuries.

Side air bag (if equipped)

Your vehicle is equipped with a side air bag in each front seat.



* The actual air bags in the vehicle may differ from the illustration.

The purpose of the air bag is to provide the vehicle's driver and/or front passenger with protection in addition to that offered by the seat belt alone.

The side air bags are designed to deploy only during certain side-impact collisions, depending on the crash severity. The side air bags and driver's center air bag are not designed to deploy in all side impact situations.

⚠ WARNING

- Do not allow the passengers to lean their heads or bodies onto doors, put their arms on the doors, stretch their arms out of the window, or place objects between the doors and passengers when they are seated on seats equipped with side and/or curtain air bags.
- The side air bags are supplemental to the driver's and the passenger's seat belt systems and is not a substitute for them. Therefore your seat belts must be worn at all times while the

vehicle is in motion. The air bags deploy only in certain side impact or rollover conditions severe enough to cause significant injury to the vehicle occupants.

- For best protection from the side air bag system and to avoid being injured by the deploying side air bag, both front seat occupants should sit in an upright position with the seat belt properly fastened.
- Do not use any accessory seat covers.
- Use of seat covers could reduce or prevent the effectiveness of the system.
- To prevent unexpected deployment of the side air bag and driver's center air bag that may result in personal injury, avoid impact to the side impact sensor when the START/STOP button is in ON position and within approximately 3 minutes after the vehicle is in OFF position.
- If the seat or seat cover is damaged, have the system serviced by a professional workshop.

Kia recommends visiting an authorized Kia dealer/service partner.

- Do not place any objects over the air bag or between the air bag and yourself. Also, do not attach any objects around the area the air bag inflates such as the door, side door glass, front and rear pillar.
- Do not place any objects between the door and the seat. They may become dangerous projectiles if the side air bag inflates.
- Do not install any accessories on the side or near the side air bags.

Curtain air bag (if equipped)

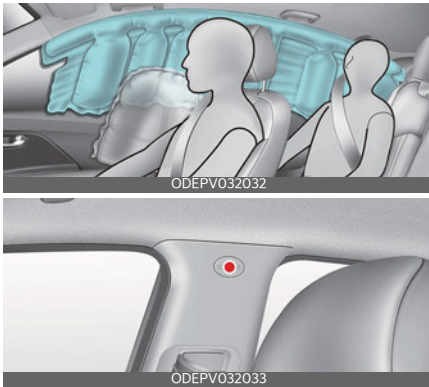

* The actual air bags in the vehicle may differ from the illustration.

Curtain air bags are located along both sides of the roof rails above the front and rear doors.

They are designed to help protect the heads of the front seat occupants and the rear outboard seat occupants during certain side impact collisions.

The curtain air bags are designed to deploy during certain side impact collisions, depending on the crash severity. The curtain air bags are not designed to deploy in all side impact situations, or during collisions from the front or rear of the vehicle or in most rollover situations.

⚠ WARNING

- Failure to follow the instructions mentioned can result in injury or death to the vehicle occupants in an accident.
 - Do not hang heavy items on the coat hooks for safety reasons.
 - In order for side and curtain air bags to provide the best protection, both front seat occupants and both outboard rear occupants should sit in an upright position with the seat belts properly fastened.

Importantly, children should sit in a proper child restraint system in the rear seat.

- When children are seated in the rear outboard seats, they must be seated in the proper child restraint system.
 - Make sure to put the child restraint system as far away from the door side as possible, and secure the child restraint system in a locked position.
- Do not allow the passengers to lean their heads or bodies onto doors, put their arms on the doors, stretch their arms out of the window, or place objects between the doors and passengers when they are seated on seats equipped with side and/or curtain air bags.
- Never try to open or repair any components of the curtain air bag system. If necessary, have the system serviced by a professional workshop. Kia recommends visiting an authorized Kia dealer/service partner.

- Do not place any objects over the air bag. Also, do not attach any objects around the area the air bag inflates such as the door, side door glass, front and rear pillar, roof side rail.
- Do not hang hard or breakable objects on the clothes hanger.

Air bag collision sensors



ODEPV032034



* The actual features in your vehicle may not necessarily be available due to the selected options or regions.

- 1 Supplemental Restraint System (SRS) control module
- 2 Front impact sensor
- 3 Side pressure sensors (front door)
- 4 Side impact sensor (B-pillar)

⚠ WARNING

- Do not hit or allow any objects to impact the locations where air bag or sensors are installed.

This may cause unexpected air bag deployment, which could result in serious personal injury or death.

- If the installation location or angle of the sensors is altered in any way, the air bags may deploy when they should not or they may not deploy when they should, causing severe injury or death.



Therefore, do not try to perform maintenance on or around the air bag sensors. Have the system serviced by a professional workshop. Kia recommends visiting an authorized Kia dealer/service partner.

- Problems may arise if the sensor installation angles are changed due to the deformation of the front bumper, body or B pillar where side collision sensors are installed. In this case, have the system serviced by a professional workshop. Kia recommends to visit an authorized Kia dealer/service partner.

- Your vehicle has been designed to absorb impact and deploy the air bag(s) in certain collisions. Use only Kia Genuine Parts or those of an equivalent standard to install bumper guards or replace a bumper. If not, it may adversely affect your vehicle's collision and air bag deployment performance.

Air bag inflation conditions

* The actual air bags in the vehicle may differ from the illustration.

Air bag inflation conditions	
 <p>ODEPV032039</p>	<p>Front air bags are designed to inflate in a frontal collision depending on the intensity, speed or angles of impact of the front collision.</p>
 <p>ODEPV032032</p>	<p>Side and/or curtain air bags are designed to inflate when an impact is detected by side collision sensors depending on the strength, speed or angles of impact resulting from a side impact collision.</p>
 <p>ODEPV032040</p>	

*** INFORMATION**

Side and curtain air bags







Side and curtain air bags are designed to inflate when an impact is detected by side impact sensors depending on the severity of impact resulting from side collision.

Although the front air bags (driver's and front passenger's air bags) are designed to inflate only in frontal collisions, they also may inflate in other types of collisions if the front impact sensors detect a sufficient impact. Side air bags (side and/or curtain air bags) are designed to inflate only in side impact collisions, but they may inflate in other collisions if the side impact sensors detect a sufficient impact.

If the vehicle chassis is impacted by bumps or objects on unimproved roads or sidewalks, air bags may deploy. Drive carefully on unimproved roads or on surfaces not designed for vehicle traffic to prevent unintended air bag deployment.

Air bag non-inflation conditions

* The actual air bags in the vehicle may differ from the illustration.

Air bag non-inflation conditions	
 <p>ODEPV032039</p>	In certain low-speed collisions the air bags may not deploy.
 <p>ODEPV032041</p>	Air bags are not designed to inflate in rear collisions.
 <p>ODEPV032043</p>	<p>Heavy braking lowers the front portion of the vehicle causing it to "ride" under a vehicle with a higher ground clearance.</p> <p>Air bags may not inflate in this "under-ride" situation because deceleration forces that are detected by sensors may be significantly reduced by such "under-ride" collisions.</p>
 <p>ODEPV032042</p>	In an angled collision, the force of impact may send the occupants in a direction where the air bags would not be able to provide any additional benefit; thus, the sensors may not deploy any air bags.
 <p>ODEPV032040</p>	<p>Front air bags may not inflate in side impact collisions.</p> <p>However, if equipped with side and curtain air bags, the air bags may inflate depending on the intensity, vehicle speed and angles of impact.</p>
 <p>ODEPV032044</p>	Air bags may not inflate in rollover accidents because the vehicle cannot detect the rollover. However, side and/or curtain air bags may inflate when the vehicle is rolled over following (or after) side impact collision.
 <p>ODEPV032045</p>	Air bags may not inflate if the vehicle collides with objects such as utility poles or trees, meaning the point of impact is concentrated in one area and the full force of the impact is not delivered to the sensors.

⚠ WARNING

- The SRS is designed to deploy the front air bags only when an impact is sufficiently severe and when the impact angle is less than 30° from the forward longitudinal axis of the vehicle.
- Front air bags are not intended to deploy in side-impact, rear-impact or rollover crashes. In addition, front air bags will not deploy in frontal crashes below the deployment threshold.
- The air bags deploy only in certain side impact or rollover conditions severe enough to cause significant injury to the vehicle occupants.
- If an air bag deploys, there may be a loud noise followed by a fine dust released in the vehicle. These conditions are not hazardous.
- The air bags are packed in this fine power. The dust generated during air bag deployment it may cause skin or eye irritation as well as aggravate asthma for some persons. Always wash all exposed skin areas thoroughly with cold water and a mild soap after an accident in which the air bags were deployed.
- For cleaning the air bag pad covers, use only a soft, dry cloth or one which has been moistened with plain water.
- Solvents or cleaners could adversely affect the air bag covers and proper deployment of the system.
- Keep the SRS parts and wirings away from water or any liquid. If the SRS components are inoperative due to exposure to water or liquids, it may cause fire or severe injury.

- If any of the following conditions occurs, this indicates a malfunction of the SRS. In this case, have the system inspected by a professional workshop. Kia recommends visiting an authorized Kia dealer/service partner.
 - The light does not turn on briefly when you turn the vehicle ON.
 - The light stays on after illuminating for approximately 6 seconds.
 - The light comes on while the vehicle is in motion.
 - The light blinks when the START/STOP button is in ON position.
- Before you replace a fuse or disconnect a battery terminal, turn the START/STOP button to OFF position. Never remove or replace the air bag related fuse(s) when the START/STOP button is in the ON position. Failure to heed this warning will cause the SRS air bag warning light to appear.
- Do not tamper with or disconnect wiring or other components of the SRS system, including the addition of any kind of badges to the pad covers or modifications to the body structure. Doing so could adversely affect SRS performance and lead to possible injury. If necessary, have the system serviced by a professional workshop. Kia recommends visiting an authorized Kia dealer/service partner.
- If your vehicle was flooded and has soaked carpeting or water on flooring, you shouldn't try to start the vehicle; In this situation, have your vehicle inspected by a professional workshop. Kia recommends to contact an authorized Kia dealer/service partner.
- Air bags can only be used once. If the air bags inflate, have the system replaced by a professional workshop. Kia recommends visiting an authorized Kia dealer/service partner.
- If components of the air bag system must be discarded, or if the vehicle must be scrapped, certain safety precautions must be observed, such as removing SRS and pre-tensioners from a vehicle due to the risk of fire. Failure to follow these precautions and procedures could increase the risk of personal injury. An authorized Kia dealer knows these precautions and can give you the necessary information.

* NOTICE

The side and/or curtain air bags may inflate when the vehicle is rolled over by a side impact collision, if the vehicle is equipped with side air bags and curtain air bags.

SRS care

The SRS is virtually maintenance-free, and there are no parts you can safely service by yourself.

If the SRS air bag warning light does not appear, or continuously remains on, have the system inspected by a professional workshop. Kia recommends visiting an authorized Kia dealer/service partner.

WARNING

- Modification to SRS components or wiring, including the addition of any kind of badges to the pad covers or modifications to the body structure, can adversely affect SRS performance and lead to possible injury.
- If components of the air bag system must be discarded, or if the vehicle must be scrapped, certain safety precautions must be observed. An authorized Kia dealer knows these precautions and can give you the necessary information. Failure to follow these precautions and procedures could increase the risk of personal injury.

Additional safety precautions

- **Never let passengers ride in the cargo area or on top of a folded-down back seat.** All occupants should sit upright, fully back in their seats with their seat belts on and their feet on the floor.
- **Passengers should not move out of or change their seat while the vehicle is moving.** A passenger who is not wearing a seat belt during a crash or emergency stop can be thrown against the inside of the vehicle, against other occupants, or out of the vehicle.
- **Each seat belt is designed to restrain one occupant.** If more than one person uses the same seat belt, they could be seriously injured or killed in a collision.
- **Do not use any accessories on seat belts.** Devices claiming to improve occupant comfort or reposition the seat belt can reduce the protection provided by the seat belt and increase the chance of serious injury in a crash.
- **Passengers should not place hard or sharp objects between themselves and the air bags.** Carrying hard or sharp objects on your lap or in your mouth can result in injuries if an air bag inflates.
- **Keep occupants away from the air bag covers.** All occupants should sit upright, fully back in their seats with their seat belts on and their feet on the floor. If occupants are too close to the air bag covers, they could be injured if the air bags inflate.
- **Do not attach or place objects on or near the air bag covers.** Any object attached to or placed on the front or side air bag covers could interfere with the proper operation of the air bags.
- **Do not modify the front seats.** Modification of the front seats could interfere with the operation of the supplemental restraint system sensing components or side air bags.
- **Do not place items under the front seats.** Placing items under the front seats could interfere with the operation of the supplemental restraint system sensing components and wiring harnesses.
- **Never hold an infant or child on your lap.** The infant or child could be seriously injured or killed in the event of a crash. All infants and children should be properly restrained in appropriate child safety seats or seat belts in the rear seat.

WARNING

- Sitting improperly or out of position can cause occupants to be shifted too close to a deploying air bag, strike the interior structure or be thrown from the vehicle resulting in serious injury or death.
- Always sit upright with the seatback in an upright position, centered on the seat cushion with your seat belt on, legs comfortably extended and your feet on the floor.

Adding equipment to or modifying your air bag-equipped vehicle

Modifying your vehicle by changing your vehicle's frame, bumper system, front end or side sheet metal, or ride height may affect the operation of your vehicle's air bag system.

Air bag warning labels

Left-hand drive



Right-hand drive



Air bag warning label (Type A)



Air bag warning label (Type B)

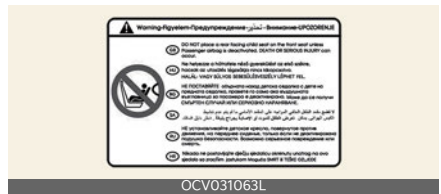

Air bag warning labels are attached to alert the passengers to potential risks of the air bag system.

Note that these government warnings focus on the risks to children. We also want you to be aware of the risks that adults are exposed to, which have been described in previous pages.

WARNING

- Never place a rear facing child restraint in the front passenger seat, unless the passenger-side air bag is deactivated. An inflating passenger-side air bag could impact the rear-facing child restraint and kill the child.
- Extreme Hazard! Do not use a rearward facing child restraint on a seat protected by an air bag in front of it!
- Never put a child restraint in the front passenger's seat. If the front passenger air bag inflates, it can cause serious or fatal injuries.
- NEVER use a rearward facing child restraint on a seat protected by an ACTIVE AIR BAG in front of it. DEATH or SERIOUS INJURY to the CHILD can occur.

- When children are seated in the rear outboard seats of a vehicle equipped with side and/or curtain air bags, be sure to install the child restraint system as far away from the door side as possible, and securely lock the child restraint system in position.
Inflation of side and/or curtain air bags could cause serious injury or death to an infant or child.
-

*** NOTICE**

If equipped with rollover sensor

- The air bags inflate instantly in the event of a rollover (if equipped with a side air bag or curtain air bag) in order to help protect the occupants from serious physical injury.
 - The side and/or the curtain air bag may deploy when the rollover sensor detects the situation as a rollover.
-

Features of your vehicle **5**

Keys	5-5
• Record your key number.....	5-5
• Using the smart key.....	5-5
• Removing the mechanical key from the smart key.....	5-5
• Replacing the key battery.....	5-6
Theft-alarm system	5-7
• Armed stage.....	5-7
• Theft-alarm stage.....	5-7
• Disarmed stage.....	5-7
Immobilizer system	5-8
• Vehicles with smart key system.....	5-8
Door locks	5-9
• Door locks outside the vehicle.....	5-9
• Door locks inside the vehicle.....	5-11
• Automatic door lock and unlock features.....	5-12
• Deadlocks.....	5-13
• Child-protector rear door lock.....	5-13
• Rear Occupant Alert (ROA).....	5-14
Tailgate	5-15
• Opening/closing the manual tailgate.....	5-15
• Tailgate emergency safety release.....	5-15
Windows	5-16
• Controlling windows switch.....	5-18
• Resetting the power windows.....	5-18
• Power windows automatic reversal.....	5-18
• Power windows lock button.....	5-19
Hood	5-20
• Opening the hood.....	5-20
• Closing the hood.....	5-20

5 Features of your vehicle

Charging door	5-21
• Opening the charging door	5-21
• Closing the charging door	5-21
Steering wheel	5-23
• Adjusting the steering wheel angle and height	5-23
• Heated steering wheel	5-23
• Horn	5-23
Mirrors	5-25
• Interior rear view mirror	5-25
• Outside rear view mirror	5-26
Instrument cluster	5-28
• Adjusting instrument cluster illumination	5-30
LCD display	5-31
• Changing LCD display modes	5-31
• LCD display modes	5-31
• LCD display messages	5-37
Warning and indicator lights	5-39
Lighting	5-42
• Battery saver function	5-42
• Headlamp escort function	5-42
• Daytime Running Light (DRL)	5-43
• Traffic change (For Europe)	5-43
• Lighting controls	5-43
• High Beam Assist (HBA)	5-45
• Headlamp leveling adjustment switch	5-47
Wipers and washers	5-48
• Wipers	5-48
• Washers	5-48
Welcome system	5-50
• Door handle lamp	5-50

Features of your vehicle **5**

• Headlamp escort function.....	5-50
• Interior lighting.....	5-50
Interior lights.....	5-51
• Map lamp.....	5-51
• Room lamp.....	5-51
• Luggage room lamp	5-51
• Vanity mirror lamp	5-52
Climate control system	5-52
Automatic climate control system.....	5-55
• Operating the climate control system	5-56
• Controlling heating and air conditioning automatically.....	5-59
• Controlling the temperature	5-59
• Driver only mode.....	5-59
• Changing temperature scale	5-59
• Controlling fan speed.....	5-59
• Climate information screen selection	5-60
• Heat button.....	5-60
• OFF mode.....	5-61
Windshield defrosting and defogging	5-63
• Defrosting/defogging the windshield	5-63
• Rear window/outside mirror defroster	5-63
• Auto defogging for automatic climate control	5-63
Storage compartment	5-64
• Center console storage/glove box	5-64
• Luggage board.....	5-64
• Sunglass holder	5-65
• Luggage net holder.....	5-65
• Cargo security screen	5-65
Interior features.....	5-66
• Ambient lights.....	5-66
• Cup holders	5-66

5 Features of your vehicle

- Ashtray..... 5-67
- Seat warmer/ventilation..... 5-67
- Sun visor 5-69
- USB charger 5-69
- Power outlet 5-70
- Wireless smart phone charging system..... 5-70
- Coat hook 5-72
- Floor mat anchors..... 5-73
- Audio system..... 5-73**
 - Antenna 5-73
 - USB port..... 5-73
 - How vehicle radio works..... 5-74

Features of your vehicle

* The information provided may differ according to which functions are applicable to your vehicle.

Keys

Record your key number

The key code number is stamped on the key code tag attached to the key set.

If you lose your keys, Kia recommends contacting an authorized Kia dealer/service partner. Remove the key code tag and store it in a safe place. Also, record the key code number and keep it in a safe place (not in the vehicle).

Using the smart key



ODEPV042002L

- 1 Lock
- 2 Unlock
- 3 Tailgate unlock

Operation

- Press the corresponding button.

Non-operating condition(s)

- Being close to a radio transmitter such as a radio station or an airport which can interfere with normal operation of the smart key.
- Being near a mobile two-way radio system or a cellular phone.
- Another vehicle's smart key is being operated close to your vehicle.

* INFORMATION

- If you press the tailgate unlock button for longer than a second, the lock will be released or the tailgate will be opened according to the options of the vehicle.
- If any door, hood or tailgate remains open, the hazard warning lights will not operate.
- After pressing unlock button, the doors will lock automatically unless you open any door within 30 seconds.
- After pressing the lock/unlock button, The hazard warning lights will flash.
- If no further action for operating/driving the vehicle is taken, the vehicle will be turned off 10 minutes after starting the vehicle remotely.

Removing the mechanical key from the smart key

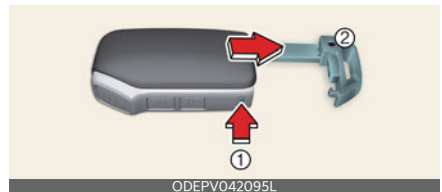

ODEPV042095L

- 1 Tab
- 2 Mechanical key

Operation

1. Press and hold the tab (1).
2. Pull the mechanical key (2) out.

Replacing the key battery

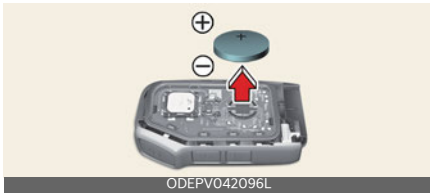

Operation

1. Pry open the key cover gently.
2. Replace the old battery with a new battery.

* INFORMATION

The battery is CR2032 (3V).

⚠ WARNING

- Never leave the keys in your vehicle with unsupervised children. Leaving children unattended in a vehicle with the Smart key is dangerous even if the START/STOP button is not in the ACC or ON position. Children copy adults and they could press the START/STOP button. The key would enable children to operate power windows or other controls, or even make the vehicle move, which could result in serious bodily injury or death.
- **THIS PRODUCT CONTAINS A BUTTON BATTERY**

If swallowed, a lithium button battery can cause severe or fatal injuries within 2 hours.

Keep batteries out of reach of children.

If you think batteries may have been swallowed or placed inside any part of the body, seek immediate medical attention.

⚠ CAUTION

- The smart key is designed to give you years of trouble-free use, however it can malfunction if exposed to moisture or static electricity. If you are unsure how to use or replace the battery, Kia recommends to contact an authorized Kia dealer/service partner.
- Using the wrong battery can cause the smart key to malfunction. Be sure to use the correct battery.
- To avoid damaging the smart key, don't drop it, get it wet, or expose it to heat or sunlight.



- An inappropriately disposed battery can be harmful to the environment and human health. Dispose the battery according to your local law(s) or regulation.

* NOTICE

- If, for some reason, you happen to lose your smart key, you will not be able to start the vehicle. Tow the vehicle, if necessary, contact a professional workshop. Kia recommends to contact an authorized Kia dealer/service partner.
- A maximum of 2 smart keys can be registered to a single vehicle. If you lose a smart key, Kia recommends to contact an authorized Kia dealer/service partner.
- When the smart key does not work properly, open and close the door with the mechanical key. If you have a problem with the smart key, Kia recommends to contact an authorized Kia dealer/service partner.

Theft-alarm system



The system provides an audible alarm and the hazard warning lights blink if triggered. The system is operated in 3 stages.

Armed stage

Operation

1. Lock the doors by pressing the lock button on the key or door handle.
2. The hazard warning lights will blink once to indicate that the system is armed.
3. The chime will sound for approximately 3 seconds if any doors remain open.

Operating condition(s)

- 30 seconds after all doors are closed and locked.
- START/STOP button is in the OFF position.

Theft-alarm stage

Operation

1. The horn will sound.
2. The hazard warning lights will blink continuously for approximately 30 seconds.
3. Unlock the doors with the key to turn off the system.

Disarmed stage

Operation

1. The hazard warning lights will blink twice after the doors are unlocked.
2. After pressing the door unlock button, if any door (or tailgate) is not opened within 30 seconds, the system will be rearmed.

Operating condition(s)

- Door unlock button is pressed.
- The button of the front outside door is pressed while carrying the smart key.
- The vehicle is started. (within 3 seconds)
- After pressing the unlock button, the hazard warning lights will blink and the chime will sound twice (in smart key) to indicate that the system is disarmed.
- After pressing the unlock button, if any door (or tailgate) is not opened within 30 seconds, the system will be rearmed.

⚠ CAUTION

- Do not attempt to alter this system or add other devices to it. Electrical problems could result that may make your vehicle inoperable.
- Do not change, alter or adjust the theft-alarm system because it could cause the theft-alarm system to malfunction. In this case, have the system serviced by a professional workshop. Kia recommends visiting an authorized Kia dealer/service partner. Malfunctions caused by improper alterations, adjustments or modifications to the theft-alarm system are

not covered by your vehicle manufacturer warranty.

- Do not attempt to alter this system or add other devices to it. Electrical problems could result that may make your vehicle inoperable.

*** NOTICE**

Avoid trying to start the engine while the alarm is activated. The vehicle starting motor is disabled during the theft-alarm stage.

Immobilizer system

The immobilizer system checks, determines, and verifies the key whenever the vehicle is in the ON position.

Whenever the START/STOP button is changed to the ON position, the immobilizer system checks and verifies if the key is valid or not.

If the key is valid, the vehicle will start.

If the key is invalid, the vehicle will not start.

Vehicles with smart key system

Deactivating the immobilizer system

Operation

- Change the START/STOP button to the ON position.

Activating the immobilizer system

Operation

Change the START/STOP button to the OFF position. The immobilizer system activates automatically. Without a valid smart key for your vehicle, the vehicle will not start.

⚠ WARNING

In order to prevent theft of your vehicle, do not leave spare keys anywhere in your vehicle. Your immobilizer password is a customer unique password and should be kept confidential. Do not leave this number anywhere in your vehicle.

⚠ CAUTION

- Do not put metal accessories near the START/STOP button. Metal accessories may interrupt the transponder signal and may prevent the vehicle from being started.
- The transponder in your START/STOP button is an important part of the immobilizer system. It is designed to give years of trouble-free service, however you should avoid exposure to moisture, static electricity and rough handling. Immobilizer system malfunction could occur.
- Do not change, alter or adjust the immobilizer system because it could cause the immobilizer system to malfunction. In this case, have the system serviced by a professional workshop. Kia recommends visiting an authorized Kia dealer/service partner.
Malfunctions caused by improper alterations, adjustments or modifications to the immobilizer system are not covered by your vehicle manufacturer warranty.
- Do not attempt to alter this system or add other devices to it. Electrical problems could result that may make your vehicle inoperable.

*** NOTICE**

- When starting the vehicle, do not use the key with other immobilizer keys around. Otherwise the vehicle may not start or may stop soon after it starts. Keep each key separately in order to avoid a starting malfunction.
- If you need additional keys or lose your keys, Kia recommends visiting an authorized Kia dealer/service partner.

Door locks**Door locks outside the vehicle****Locking/unlocking with the smart key****Operation**

1. Press the front door handle button (driver's side).
2. Hazard warning lights will blink and the chime will sound.
 - Locking: Once
 - Unlocking: Twice

Operating condition(s)

- All doors are closed
- Smart key is detected within 0.7~1 m (28~40 inches)

Non-operating condition(s)

- Smart key is in the vehicle.
- The vehicle is in ACC or ON position.
- Doors (except tailgate) is opened.

⚠ CAUTION

When leaving your vehicle with a smart key, be sure to close all doors (including hood and tailgate) and check by pressing the front door handle button. If the button is unpressed, the doors are unlocked.

* NOTICE

- After pressing the button, the doors will lock automatically unless you open any door within 30 seconds.
- By pulling the driver-side exterior door handle, you can find whether the door has locked or not.
- Make sure the doors are closed securely.
- If the door is locked/unlocked multiple times in rapid succession with either the vehicle key or door lock switch, the system may stop operating temporarily to protect the circuit and prevent damage to system components.
- Always place the vehicle in the OFF position, engage the parking brake, close all windows, and lock all doors when leaving your vehicle unattended.
- If the Welcome Mirror/Light function is selected, the outside rear view mirror will automatically unfold when the doors are unlocked.

Limitation(s)

- Smart key is detected within 0.7~1 m (28~40 inches).

Locking/unlocking with the mechanical key



Operation

1. Pull out the mechanical key from smart key.
2. Insert the mechanical key into the keyhole outside of driver's door.
3. Turn the key to unlock.

⚠ WARNING

- If you don't close the door securely, the door may open again.
- Be careful that someone's body and hands are not trapped when closing the door.
- If people must spend a longer time in the vehicle while it is very hot or cold outside, there is risk of injuries or danger to life. Do not lock the vehicle from the outside when there are people in it.

⚠ CAUTION

Do not frequently repeat opening and closing of doors, or apply excessive force to a door while the door closer is operating.

*** NOTICE**

- When locking the door with a mechanical key, be aware that only the driver's door can be locked/unlocked.
- To lock all doors, operate the central lock switch inside the vehicle. Open the car door using the inner handle, then close the door and lock the driver's door with a mechanical key.
- Refer to "Door locks inside the vehicle" on page 5-11 to lock from inside the vehicle.
- Be careful not to lose or scratch the cover when removing it.
- When the key cover freezes and does not open, tap it lightly or indirectly warm (hand temperature, etc.) it up.
- Do not apply excessive force to the door and door handle. It may be damaged.
- If the door is locked/unlocked multiple times in rapid succession with either the vehicle key or door lock switch, the system may stop operating temporarily in order to protect the circuit and prevent damage to system components.

Door locks inside the vehicle

Unlocking with the door handle



- 1 Door lock switch
- 2 Door handle

Operation

1. To unlock a door, pull the door lock switch (1) to the "Unlock" position.
2. To lock a door, push the door lock switch (1) to the "Lock" position.
3. Pull the door handle (2) to open a door.

Locking/unlocking with the central locking switch



- 1 Door lock button
- 2 Door unlock button

Operation

1. To lock all vehicle doors, press the left side (1) of the switch.
2. To unlock all vehicle doors, press the right side (2) of the switch.

*** INFORMATION**

Any door is opened, the doors will not lock even though the central door lock switch is pressed.

⚠ WARNING

- If a power door lock ever fails to function while you are in the vehicle, try one or more of the following techniques to exit:
 - Operate the door unlock feature repeatedly (both electronic and manual) while simultaneously pulling on the door handle.
 - Operate the other door locks and handles, front and rear.

- Lower a front window and use the mechanical key to unlock the door from outside.
- Move to the cargo area and open the tailgate.
- Do not pull the inner door handle of driver's (or passenger's) door while the vehicle is moving.
- The doors should always be fully closed and locked while the vehicle is in motion to prevent accidental opening of the door. Locked doors will also discourage potential intruders when the vehicle stops or slows down.
- Be careful when opening doors and watch out for vehicles, motorcycles, bicycles or pedestrians approaching the vehicle in the path of the door. Opening a door when something is approaching can result in an accident to cause vehicle damage or serious injury.
- Leaving your vehicle unlocked can invite theft or possible harm to you or others from someone hiding in your vehicle while you are gone. Always remove the smart key, engage the parking brake, close all windows and lock all doors when leaving your vehicle unattended.
- **Unattended children, the elderly or pets**
An enclosed vehicle can become extremely hot, causing death or severe injury such as heatstroke to unattended children, the elderly or pets who cannot escape the vehicle. When left or trapped in a hot vehicle, make sure to stay hydrated and avoid sun exposure through the vehicle's windshield. Furthermore, children might operate features of the vehicle that could injure them, or they could

encounter other harm, possibly from someone gaining entry to the vehicle. Never leave children or animals unattended in your vehicle.

Automatic door lock and unlock features

Your vehicle is equipped with features that will automatically lock or unlock your vehicle based on settings you select in the infotainment system screen.

Auto lock enable on speed

When this feature is set in the infotainment system screen, all the doors will be locked automatically when the vehicle exceeds 15 km/h (9 mph).

Auto lock enable on shift

When this feature is set in the infotainment system screen, all the doors will be locked automatically when the vehicle is shifted out of P (Park) while the vehicle is running.

Auto unlock on shift to P

When this feature is set in the infotainment system screen, all the doors will be locked automatically when the vehicle is shifted out of P (Park) while the vehicle is running.

Auto unlock vehicle off

When this feature is set in the infotainment system screen, all the doors will be unlocked automatically when the vehicle is turned off.

Impact sensing door unlock system

All doors will automatically unlock when an impact causes the air bags to deploy.

Speed sensing door unlock system (if equipped)

All doors will automatically lock after the vehicle speed exceeds 15 km/h (9 mph).

Additional unlock safety feature air bag deployment

When this feature is set in the infotainment system screen, all the doors will be unlocked automatically when the vehicle is turned off.

Deadlocks (if equipped)

Some vehicles are equipped with deadlock system. Deadlocks prevent opening of a door from either inside or outside the vehicle once the deadlocks have been activated providing an additional measure of vehicle security.

To lock the vehicle using the dead lock function, the doors must be locked by using the smart key. To unlock the vehicle, the smart key must be used again.

Child-protector rear door lock

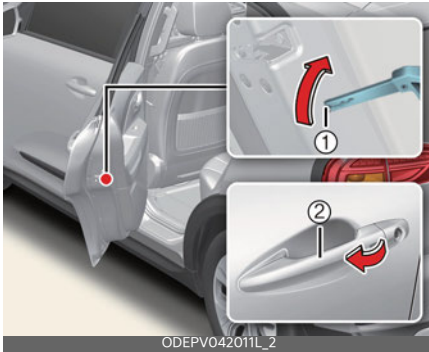

Operation

1. Insert the mechanical key.
2. Turn the child safety lock to the lock position (1).

3. To allow a rear door to be opened from inside the vehicle, unlock the child safety lock.
4. To open the rear door, pull the outside door handle (2).

⚠ WARNING

- If children accidentally open the rear doors while the vehicle is in motion, they could fall out and be severely injured or killed. To prevent children from opening the rear doors from the inside, the rear door safety locks should be used whenever children are in the vehicle.
- The system does not detect every obstacle approaching the vehicle exit.
- The driver and passenger are responsible for the accident occurred while exiting the vehicle. Always check the surrounding before you exit the vehicle.

Rear Occupant Alert (ROA) (if equipped)

The Rear Occupant Alert (ROA) is provided to help prevent exiting the vehicle with a rear passenger left in the vehicle.

Operation

- Select **Convenience** → **Rear Occupant Alert** on the Settings menu.

Alert operation

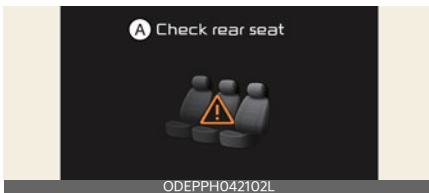

A: Check rear seats

When you turn off the vehicle and open the driver's door after opening and closing the rear door or tailgate, the warning message appears on the cluster.

⚠ WARNING

Rear Occupant Alert provides information to the driver to check the rear seats but it does not detect whether there is an object or passenger in the back seats. Always make sure to check the rear seats before you leave the vehicle.

⚠ CAUTION

The door open and close history is initialized when the driver turns off the engine and locks the vehicle door. Even though the rear door is not opened again, an alert may occur if the previous history is not initialized. For example, if driver does not lock the vehicle door and opens the door to get off after the alert sounds, the alert may go off.

Tailgate

Opening/closing the manual tailgate



Operation

1. Press the outside handle switch (1) to open the tailgate.
2. Pull up the tailgate.
3. Push down the tailgate to close it. Make sure that the tailgate is securely latched.

Operating condition(s)

- The tailgate is locked or unlocked using the key or central door lock switch.

Tailgate emergency safety release

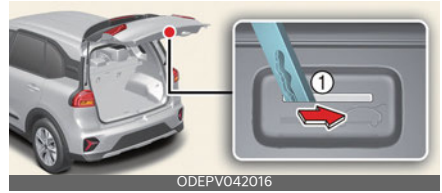

Operation

1. Insert the mechanical key into the keyhole.
2. Move the mechanical key to the right (1).
3. Push the tailgate upward.

⚠ WARNING

- For emergencies, be fully aware of the location of the emergency tailgate safety release lever in the vehicle and how to open the tailgate if you are accidentally locked in the luggage compartment.
- No one should be allowed to occupy the cargo area of the vehicle at any time. The cargo area is a very dangerous location in the event of a crash.
- Use the release lever for emergencies only. Use with extreme caution, especially while the vehicle is in motion.
- Do not grasp the part supporting the tailgate (gas lifter), as this may cause serious injury.



Windows

Left-hand drive

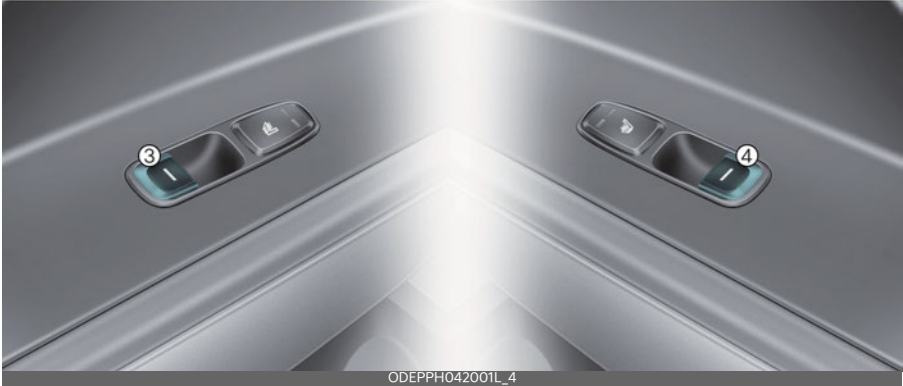

ODEPPH042001L_4

Right-hand drive



ODEPV042001R_4

- 1 Driver's door power window switch
- 2 Front passenger's door power window switch
- 3 Rear door (left) window switch
- 4 Rear door (right) window switch
- 5 Power window lock switch

Controlling windows switch



- Type A: 1
- Type B (if equipped): 1, 2

Operation

- Press or pull the switch to the first (1)/second (2) detent position.

* INFORMATION

Only type B can use auto up/down function (2).

Operating condition(s)

- The vehicle is in the ON position

⚠ WARNING

Do not install any accessories in the area of windows. It may impact jam protection.

* NOTICE

- While driving with the rear windows down, your vehicle may demonstrate a wind buffeting or pulsation noise. This noise is a normal occurrence and can be reduced or eliminated by taking the following actions. If the noise occurs with one or both of the rear windows down, partially lower both front windows approximately one inch.

- In cold and wet climates, power windows may not work properly due to freezing conditions.

Resetting the power windows

Operation

1. Close the window.
2. Pull the power window switch.
 - Approximately 1 second

Operating condition(s)

- The vehicle is in the ON position.

Power windows automatic reversal

Operation

1. Windows will stop and move down.
 - Approximately 30 cm (12 inches)
2. Windows will move down.
 - Approximately 2.5 cm (1 inch)

Operating condition(s)

- Object or part of the body is detected
- Force is detected

⚠ WARNING

- Always check for obstructions before raising any window to avoid injuries or vehicle damage. If an object less than 4 mm (0.16 inches) in diameter is caught between the window glass and the upper window channel, the automatic reverse window may not detect the resistance and will not stop and reverse direction.

- The automatic reverse feature is not activated while resetting power window system. Make sure body parts or other objects are safely out of the way before closing the windows to avoid injuries or vehicle damage.
- Always double check to make sure all arms, hands, head and other obstructions are safely out of the way before closing a window.
- Do not allow children play with the power windows. Keep the driver's door power window lock button in the LOCK position (pressed). SERIOUS INJURY can result from unintentional window operation by the child.
- Do not extend heads or any limbs outside the window while the vehicle is in motion.

* NOTICE

The automatic reverse feature for the window is only active when the "auto up" feature is used by fully pulling up the switch. The automatic reverse feature will not operate if the window is raised using the halfway position on the power window switch.

Power windows lock button



ODEPV042020

Operation

1. Push the power windows lock button.
 - Rear passenger window is inoperable.
2. The front driver and passenger window can be operated.

⚠ WARNING

- NEVER leave the keys in your vehicle with unsupervised children, when the vehicle is running.
- NEVER leave any child unattended in the vehicle. Even very young children may inadvertently cause the vehicle to move, entangle themselves in the windows, or otherwise injure themselves or others.

⚠ CAUTION

- To prevent possible damage to the power window system, do not open or close two windows or more at the same time. This will also ensure the longevity of the fuse.
- Never try to operate the main switch on the driver's door and the individual door window switch in opposite directions at the same time. If this is done, the window will stop and cannot be opened or closed.

Hood

Opening the hood



- 1 Hood release lever
- 2 Hood secondary latch
- 3 Hood
- 4 Support rod

Operation

1. Pull the hood release lever (1).
2. Push the secondary latch (2) to the left.
3. Lift the hood (3) upwards.
4. Pull out the support rod (4).
5. Hold the hood opened with the support rod.

⚠ WARNING

- Open the hood after turning off the engine on a flat surface, shifting the gear to the P (Park) position and setting the parking brake.

- Grasp the support rod in the area wrapped in rubber. The rubber will help prevent you from being burned by hot metal when the engine is hot.
- The support rod must be inserted completely into the hole provided in the hood whenever you inspect the engine compartment. This will prevent the hood from falling and possibly injuring you.

Closing the hood



Operation

1. Before closing the hood, check the following:
 - All filler caps in the engine compartment must be correctly installed.
 - Gloves, rags or any other combustible material must be removed from the engine compartment.
2. Lower the hood until it is about 30 cm (12 inches) above the closed position and let it drop. Make sure that it locks into place.
3. Check that the hood has engaged properly.
 - If the hood can be raise slightly, it is not properly engaged.
 - Open it again and close it with a little more force.

⚠ WARNING

- Before closing the hood, ensure that all obstructions are removed from the hood opening. Closing the hood with an obstruction present in the hood opening may result in property damage or severe personal injury.
- Do not leave gloves, rags or any other combustible material in the engine compartment. Doing so may cause a heat-induced fire.
- Always double check to be sure that the hood is firmly latched before driving away. If it is not latched, the hood could open while the vehicle is being driven, causing total loss of visibility, which might result in an accident.
- Do not move the vehicle with the hood raised. The view will be blocked and the hood could fall or be damaged.

Charging door**Opening the charging door****Operation**

- Press the right center edge of the charging door.
- The charging door is not open when the vehicle is locked.

Closing the charging door**Operation**

- Close the charging door by pressing rear center edge of the charging door.

⚠ WARNING

Do not leave the vehicle with the charging door open. An open charging door may indicate that the vehicle door has been unlocked and may be subject to vehicle theft.

⚠ CAUTION

- The charging door opens to the right. Check the surrounding while the charging door is open or close. Be aware of your head or limbs from being hit or stuck to the charging door.
- Do not hold the hinge to prevent damaging the charging door and causing other accidents.

*** NOTICE**

- If the charging door does not open because ice has formed around it, tap lightly or push on the door to break the ice and release the door. If necessary, use hand temperature to melt down the ice or move the vehicle to a warm place and allow the ice to melt. Do not pry on the charging door or use unauthorized tools to open the charging door.
- After closing the charging door, push the door again to ensure that the charging door is completely closed.
- Make sure that the charging door is closed before driving the vehicle. If the charging door is opened, mechanical parts of the charging door can be damaged.
- After closed the charging door, be sure to check the warning light is off.
- After charging the vehicle, close the charging inlet by the charging inlet cover properly. If the charging inlet cover is closed improperly, the charging inlet and the charging door can be damaged.

- Do not pry on the charging door while the charging door is opening. The charging door may stop moving. Also, the electrical mechanism of the charging door and its related parts can be severely damaged.
- While washing the vehicle, do not spray a high pressure water to the charging door directly. The high pressure can damage the charging door.

Steering wheel

Adjusting the steering wheel angle and height

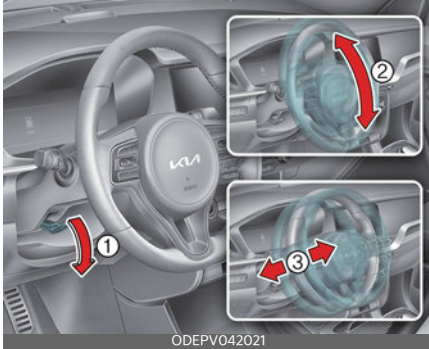

Operation

1. Pull the lock-release lever (1) down.
2. Adjust the steering wheel to the desired angle (2) and height (3).
3. Pull the lock-release lever up.

Heated steering wheel (if equipped)

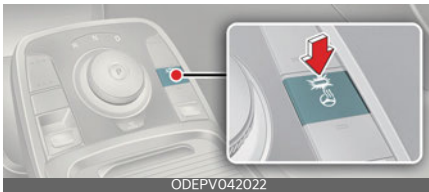

Operation

- Press the button to turn the heated steering wheel ON or OFF.
- The heated steering wheel reverts to the OFF position whenever the vehicle is restarted.

Operating condition(s)

- The vehicle should be in the ON position.

Horn

Operating the horn



Operation

- Press the area around the horn symbol on your steering wheel.

⚠ WARNING

- Never adjust the angle and height of the steering wheel while driving. You may lose steering control and cause severe personal injury, death or accidents.
- After adjusting, push the steering wheel both up and down to be certain it is locked in position.
- If the steering wheel becomes too warm, turn the system off. The heated steering wheel may cause burns even at low temperatures, especially if used for long periods of time.

⚠ CAUTION

- Do not install any type of grip cover for the steering wheel, it may impair the function of the heated steering wheel system.
- When cleaning the heated steering wheel, do not use an organic solvent such as paint thinner, benzene, alcohol and gasoline. Doing so may damage the surface of the steering wheel.

- If the surface of the steering wheel is damaged by a sharp object, damage to the heated steering wheel components could occur.
 - Do not strike the horn severely to operate it, or hit it with your fist. Do not press on the horn with a sharp-pointed object.
 - When cleaning the steering wheel, do not use an organic solvent such as thinner, benzene, alcohol and gasoline. Doing so may damage the steering wheel.
- When the abnormality is detected in the electric power steering system, a deadly accident prevention purposes, steering assist functions will be stopped. At this time, the instrument cluster warning light turns on or blinks and the power to manipulate the steering will be off. Please check immediately after moving the vehicle to a safe zone.
 - The steering effort increases if the steering wheel is rotated continuously when the vehicle is not in motion. However, after a few minutes, it will return to its normal conditions.

* NOTICE

- Be sure to adjust the steering wheel to the desired position before driving.
- After adjustment, sometimes the lock-release lever may not lock the steering wheel. It is not a malfunction. This occurs when two gears engage. In this case, adjust the steering wheel again and then lock the steering wheel.
- The following symptoms may occur during normal vehicle operation:
 - The MDPS warning light does not appear.
 - The steering effort is high immediately after pressing the START/STOP button to ON position. This happens as the MDPS system performs the diagnostics. When the diagnostics is completed, the steering effort will return to its normal condition.
 - A click noise may be heard from the MDPS relay after START/STOP button is in ON position.
 - Motor noise may be heard when the vehicle is at a stop or at a low driving speed.
- If the Electric Power Steering System does not operate normally, the warning light will appear or blink on the instrument cluster. The steering wheel may become difficult to control or operate abnormally. In this case, have the system inspected by a professional workshop. Kia recommends visiting an authorized Kia dealer/service partner.
- When you operate the steering wheel in low temperature, abnormal noise could occur. If temperature rises, the noise will disappear. This is a normal condition.
- When jump starting the vehicle after battery discharge, the steering wheel may not function properly. It is a temporary situation due to low battery voltage, and upon stable battery charging, the steering wheel will function normally again. Please move the steering wheel around to make sure the steering wheel is functioning properly before driving the vehicle.
- A click noise may be heard from the MDPS relay after turning the

START/STOP button is ON or OFF position.

- The steering effort can suddenly increase, if the operation of the MDPS system is stopped to prevent serious accidents when MDPS control unit detects malfunction of the MDPS system by self-diagnosis.
- The heated steering wheel will turn off automatically approximately 30 minutes after the heated steering wheel is turned on.

Mirrors

Interior rear view mirror

* Make the adjustment before you start driving.

Adjusting the day/night rear view mirror (if equipped)

Type A

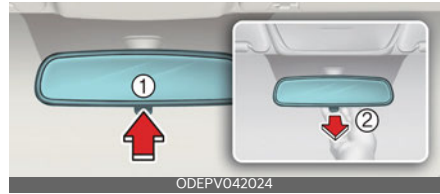

Type B

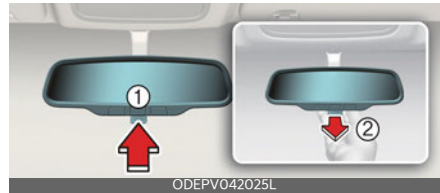

A: Day

B: Night

Operation

- Push the day/night lever (1) during daytime.
- Pull the day/night lever (2) to reduce headlamp glare during low light and nighttime driving conditions.

Electric Chromic Mirror (ECM) (if equipped)

The sensor detects the light level and automatically controls the headlamp glare during low light and nighttime driving conditions.

⚠ WARNING

- Do not place objects in the rear seat or cargo area which would interfere with your vision out the rear window.
- Do not adjust the rear view mirror while the vehicle is moving. This could result in loss of control, and an accident which could cause DEATH, SERIOUS INJURY, or property damage.
- Do not modify the inside mirror and don't install a wide mirror. It could result in injury, during an accident or deployment of the air bag.

Outside rear view mirror

Adjusting the outside rear view mirror



Operation

1. Move the outside rear view mirror switch (1) to select the left or right side of the mirror.
2. Adjust the mirror adjustment control (2) to move the selected mirror.

Folding the outside rear view mirror

Manual type (if equipped)



Operation

Grasp the housing of the mirror and fold it toward the rear of the vehicle.

Electric type (if equipped)



Operation

- Press the button to fold or unfold the mirror.

⚠ WARNING

- The outside rear view mirror is convex. Objects seen in the mirror are closer than they appear.
- Use your interior rear view mirror or direct observation to determine the actual distance of following vehicles when changing lanes.
- Do not adjust or fold the outside rear view mirrors while the vehicle is moving. This could result in loss of control, and an accident which could cause DEATH, SERIOUS INJURY, or property damage.

⚠ CAUTION

- Do not scrape ice off the mirror face; this may damage the surface of the glass. If ice should restrict the movement of the mirror, do not force the mirror for adjustment. To remove ice, use a deicer spray, or a sponge or soft cloth with warm water.
- If the mirror is jammed with ice, do not adjust the mirror by force. Use an approved spray de-icer (not cooling system antifreeze) to release the frozen mechanism or move the vehicle to a warm place and allow the ice to melt.
- The mirrors stop moving when they reach the maximum adjusting angles, but the motor continues to operate while the switch is pressed. Do not press the switch longer than necessary, the motor may be damaged.
- Do not attempt to adjust the outside rear view mirror by hand. Doing so may damage the parts.
- The electric type outside rear view mirror operates even though the vehicle is in the OFF position. However, to prevent unnecessary battery discharge, do not adjust the mirrors longer than necessary while the vehicle is not running.
- In case it is an electric type outside rear view mirror, don't fold it by hand. It could cause motor failure.
- We recommend following the procedures in an orderly manner to change or initialize the auto reversing user settings. If you move to the next step before completing the previous one, the changed angle may not be changed or initialization may not work properly.

Instrument cluster

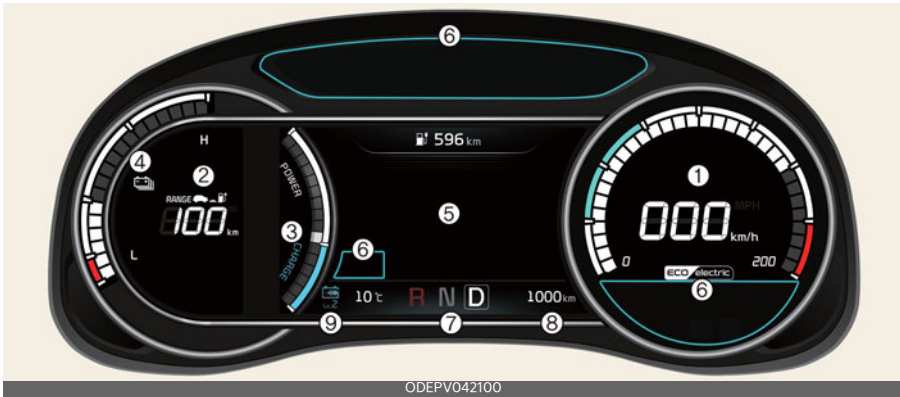

ODEPV042100

1. Speedometer

- MPH, km/h
- The speed of the vehicle in kilometers per hour (km/h) or miles per hour (mph).

2. Distance to empty

- Estimated distance the vehicle can be driven with the remaining electric energy.

3. Power/Charge gauge

- The energy consumption rate of the vehicle and the charge/discharge status of the regenerative brakes.

4. Battery SOC (State of Charge) gauge

- Charging status of the high voltage battery.

5. LCD display

- Refer to "LCD display" on page 5-31.

6. Warning and indicator lights

- Refer to "Warning and indicator lights" on page 5-39.

7. Transmission shift indicator

- The indicator displays which gear is selected.

Reduction gear shift indicator

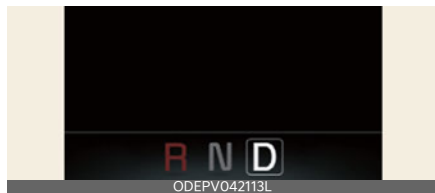

ODEPV042113L

This indicator displays which gear is selected.

- Park: P
- Reverse: R
- Neutral: N
- Drive: D

Shift indicator pop-up



The pop-up indicates the current gear position displayed continuously into other positions (P/R/N/D).

8. Odometer

- The odometer indicates the total distance that the vehicle has been driven.

9. Regenerative braking level indicator

- Refer to "Regenerative braking system" on page 6-14.

* NOTICE

- When the remaining battery is lower than 10% for the high voltage battery, the vehicle speed is limited and then eventually the vehicle will turn OFF. Charge the vehicle immediately.
- If the vehicle is not on level ground or the battery power has been interrupted, the distance to empty function may not operate correctly.
- The distance to empty may differ from the actual driving distance as it is an estimate of the available driving distance.
- The distance to empty may vary significantly based on driving conditions, driving habits, and condition of the vehicle.

- Use a clean soft microfiber cloth to gently wipe any finger prints off the touch screen.
- The instrument cluster for the right-hand drive vehicle may be on the opposite side show differently.
- If the vehicle is not on level ground or the battery power has been interrupted, the distance to empty function may not operate correctly.
- The distance to empty may differ from the actual driving distance as it is an estimate of the available driving distance.
- As the period of use of the vehicle or total mileage increases, the vehicle's mileage may decrease to protect the battery.
- The fuel economy and distance to empty may vary significantly based on driving conditions, driving habits, and condition of the vehicle.
- Use a clean soft microfiber cloth to gently wipe any finger prints off the screen.

Adjusting instrument cluster illumination (if equipped)

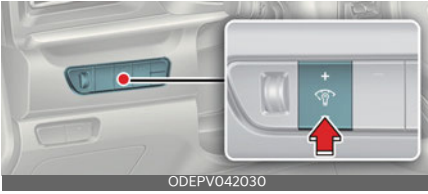

Operation

Press the illumination control button (+) or (-).

Operating condition(s)

- The vehicle is ON position
- Light switch is in parking light/AUTO*/low beam position

LCD display

Changing LCD display modes

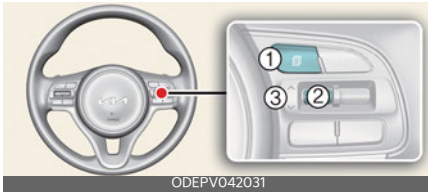

ODEPV042031

- 1 : MODE button for changing modes
- 2 : MOVE switch for changing items
- 3 : SELECT/RESET button for setting or resetting the selected item

LCD display modes

*: if equipped

		Mode				
		Trip Computer	Turn By Turn (TBT)*	Driving Assist	User Settings	Master Warning
^ v Up/ Down	Consumption info	Route Guidance	Lane Keeping Assist* Smart Cruise Control*	Driver Assistance*	The Master Warning mode displays warning messages related to the vehicle when one or more systems is not operating normally.	
	Drive Info	Destination Info	Driver Attention Warning*	Door		
	Accumulated Info		Intelligent Speed Limit Warning*	Lights		
	Driving Style		TPMS	Sound		
	Energy Flow			Convenience		
				Service Interval		
				Other		
				Language		
		Reset				

SMART/ECO pedal guide



1 ECO driving guide

2 Accelerator pedal percentage

Press drive mode button to ECO/ECO+ mode. The SMART/ECO pedal guide will appear on the instrument cluster.

Trip computer mode

* You may change through items in the following order.

Consumption info display



A: Consumption Info

1 Average

2 Instant

1. Average energy consumption

The average energy consumption is calculated by the total driving distance and the high voltage battery consumption since the last average energy consumption reset.

- **At vehicle start:** The average energy consumption will reset automatically whenever it has passed 4 hours after turning OFF the vehicle.

- **After recharging:** The average energy consumption will reset automatically when driving speed exceeds 1 km/h (1 mph), after recharging more than 10%.
- **Off:** Press and hold the OK button on the steering wheel when the average energy consumption is displayed.

2. Instant energy consumption

Displays the instant energy consumption during the last few seconds when the vehicle speed is more than approximately 10 km/h (6 mph).

Accumulated info



A: Accumulated info

1 Accumulated trip distance

2 Average energy consumption

3 Total driving time

The information is accumulated starting from the last reset.

To manually reset the information, press and hold the OK button on the steering wheel when viewing the **Accumulated Info**.

* NOTICE

- The average energy consumption is not displayed for more accurate calculation if the vehicle does not drive more than 10 seconds or approximately 50 m (0.03 miles) since the vehicle is in ON position.

- Energy consumption is calculated after the vehicle has run for more than 300 meters.

Drive info



A: Drive info

- 1 Accumulated trip distance
 - 2 Average fuel efficiency
 - 3 Total driving time
- The information after one ignition cycle. Drive Info screen will reset when the driver's door is opened after turning off the vehicle, or the vehicle is turned on after 3 minutes have passed.

Driving style

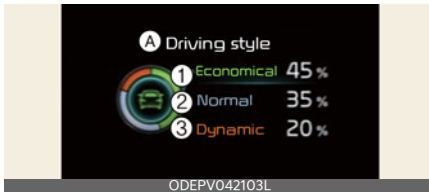

A: Driving style

- 1 Economical
 - 2 Normal
 - 3 Aggressive
- This display shows whether the driver's driving style is Economical, Normal or Aggressive.

Energy flow



A: Energy flow

The hybrid system informs the driver about its energy flow in various operating modes. While driving, the current energy flow is specified in 11 modes.

Turn By Turn (TBT) mode

This mode displays the Navigation status.

Driving Assist mode

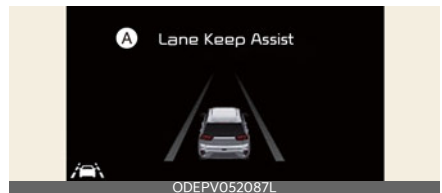

A: Lane Keep Assist

This mode displays the state of:

- Lane Keeping Assist
- Intelligent Speed Limit Warning
- Smart Cruise Control
- Lane Following Assist
- Driver Attention Warning

Master warning mode

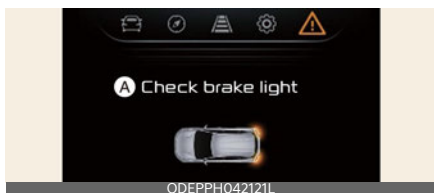

A: Check brake light

This mode informs you of the following situations:

- Driver assistance system malfunction, limitation or radar/camera blockage
- LED headlamp malfunction
- Lamp malfunction
- TPMS failure, low tire pressure, etc.

At this time, the Master warning light () will appear. If the warning situation is solved, the master warning light will be turned off and the Master Warning icon will disappear.

Service Interval

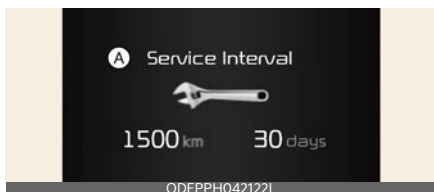

A: Service In

1 Service interval schedule

It calculates and displays when you need a scheduled maintenance service (mileage or days).

To reset the service interval, select **Convenience** → **Service Interval** → **Reset** from the Settings menu.

* NOTICE

- If the remaining mileage or time reaches 1,500 km (900 miles) or 30 days, the message **Service in** is displayed for several seconds each time you set the vehicle to the ON position.
- If you do not have your vehicle serviced according to the already inputted service interval, **Service required** message is displayed for several seconds each time you set the vehicle to the ON position.
- If any of the following conditions occurs, the mileage and days may be incorrect.
 - The battery cable is disconnected.
 - The battery is discharged.

User settings mode

In this mode, you can change the settings of the instrument cluster, doors, lights, etc.

* The information provided may differ depending on which functions are applicable to your vehicle.

1. Driver Assistance (if equipped)

Items	Explanation
Lane Safety	<ul style="list-style-type: none"> Lane Departure Warning/Lane Keeping Assist
Driver Attention Warning	<ul style="list-style-type: none"> High Sensitivity/Normal Sensitivity/Off
SCC Reaction	<ul style="list-style-type: none"> Fast/Normal/Slow
Leading Vehicle Departure Alert	Activate/Deactivate
Forward Collision-Avoidance Assist	Activate/Deactivate
Forward Collision Warning	<ul style="list-style-type: none"> Early/Normal/Late
Blind-Spot Collision Warning Sound	Activate/Deactivate
Rear Cross-Traffic Collision Warning	Activate/Deactivate
Speed Limit Warning	Activate/Deactivate

2. Door (if equipped)

Items	Explanation
Automatically Lock	<ul style="list-style-type: none"> Enable on shift/Enable on speed/Off
Automatically Unlock	<ul style="list-style-type: none"> On shift to P/Vehicle Off/On key out (if equipped)/Off

* INFORMATION

• Automatically Lock

- **Enable On Shift:** All doors will be automatically unlocked when the vehicle is shifted to P (Park) to R (Reverse), N (Neutral), or D (Drive). (With the Engine ON, it is activated.)
- **Enable On Speed:** All doors will be automatically locked when the vehicle speed is over 15 km/h (9 mph).

• Automatically Unlock

- **On Shift to P:** All doors will be automatically unlocked if the gear is shifted to the P (Park) position. (With the Engine ON, it is activated.)
- **Vehicle Off/On key out (if equipped):** All doors will be automatically unlocked when the ignition key is removed from the ignition switch or the ENGINE START/STOP button is set to the OFF position.

3. Lights (if equipped)

Items	Explanation
One Touch Turn Signal	<ul style="list-style-type: none"> Off/3/5/7 Flashes
Ambient Brightness	<ul style="list-style-type: none"> Off/1/2/3/4
Ambient Light Color	<ul style="list-style-type: none"> 8 colors
Headlight Delay	Activate/Deactivate

4. Sound (if equipped)

Items	Explanation
Parking Distance Warning Volume	<ul style="list-style-type: none"> High/Low

5. Convenience (if equipped)

Items	Explanation
Utility Mode	Yes/No
Welcome Mirror/Light	<ul style="list-style-type: none"> On door unlock/On door unlock
Wiper/Lights Display	Activate/Deactivate
Auto Rear Wiper (in R)	Activate/Deactivate
Icy Road Warning	Activate/Deactivate
Smart Regeneration	Activate/Deactivate
Rear Occupant Alert	Activate/Deactivate

6. Service Interval (if equipped)

Items	Explanation
Enable Service Interval	Activate/Deactivate
Adjust Interval	<ul style="list-style-type: none"> Time/Distance
Reset	<ul style="list-style-type: none"> Yes/No

7. Other (if equipped)

Items	Explanation
Energy Consumption Reset	<ul style="list-style-type: none"> After Refueling/After Ignition
Speed Unit	<ul style="list-style-type: none"> km/h, MPH
Temperature Unit	<ul style="list-style-type: none"> °C, °F
Tire Pressure Unit	<ul style="list-style-type: none"> psi/kPa/bar

8. Language







Items	Explanation
Language	Activate

9. Reset

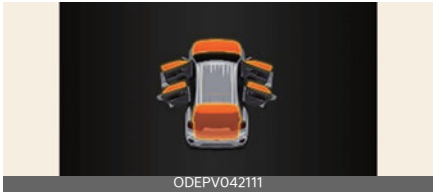
Items	Explanation
Reset	<ul style="list-style-type: none"> Yes/No

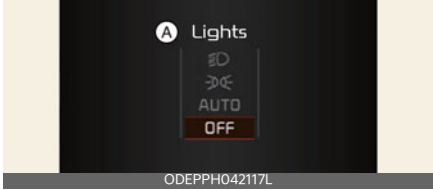
LCD display messages

* For EV warning messages, refer to "LCD display messages" on page 1-41.

LCD displays	Displayed contents
	<p>Door, hood, tailgate, sunroof open</p>
	<p>Low tyre pressure warning display A: Low tyre pressure</p>
	<ul style="list-style-type: none"> • A: Lights • 1:  • 2:  • 3: AUTO • 4: OFF (O)
	<ul style="list-style-type: none"> • A: Front wipers • 1: OFF (O) • 2: INT • 3: LO (1) • 4: HI (2)
<p>Low washer fluid</p>	<p>The washer fluid level in the reservoir is nearly empty</p>
<p>Icy road warning</p>	<p>The temperature on the outside temperature gauge is below approximately 4 °C (40 °F).</p>
<p>Low key battery</p>	<p>The battery in the smart key is flat</p>
<p>Press START button while turning wheel</p>	<p>The steering wheel does not unlock normally when the START/STOP button is pressed</p>
<p>Steering wheel unlocked</p>	<p>The steering wheel does not lock when the START/STOP button changes to the OFF position</p>
<p>Check steering wheel lock system</p>	<p>The steering wheel does not lock normally when the START/STOP button changes to the OFF position</p>
<p>Check haptic steering wheel system</p>	<p>There is a problem with the haptic steering wheel system</p>
<p>Key not in vehicle</p>	<p>The smart key is not in the vehicle when you press the START/STOP button</p>

LCD displays	Displayed contents
Key not detected	The smart key is not detected when you press the START/STOP button
Press START button again	The START/STOP button cannot be operated due to a problem with the START/STOP button system
Press START button with key	The START/STOP button is pressed while the "Key not detected" warning message is displayed
Check BRAKE SWITCH fuse	The brake switch fuse is disconnected
Refill coolant	The coolant is low

*** INFORMATION**

- If there is no problem with the operation and the messages above are constantly displayed, have your vehicle inspected by a professional workshop. Kia recommends to contact an authorized Kia dealer/service partner.
- **Press START button again**
 - You could start the vehicle by pressing the START/STOP button once more.
 - If the warning message is displayed each time you press the START/STOP button, have the vehicle inspected by a professional workshop. Kia recommends visiting an authorized Kia dealer/service partner.
- **Check BRAKE SWITCH fuse**
 - You need to replace the fuse with a new one before starting the vehicle.
 - If that is not possible, you can start the vehicle by pressing the START/STOP button for 10 seconds in the ACC position.













*** NOTICE**

















- Some driving information stored in the trip computer resets if the battery is disconnected.
- If any of the following conditions occurs, the mileage and days may be incorrect.
 - The battery cable is disconnected.
 - The battery is discharged.
- If sunroof open warning is displayed in the cluster, the Driving Information message may not be displayed.
- To set the charging time and/or climate time, refer to the manual provided in the infotainment system and the quick reference guide.
- If the icy road warning appears while driving, you should drive more attentively and safely refraining from over-speeding, rapid acceleration, sudden braking or sharp turning, etc.

Warning and indicator lights

Once you set the vehicle to the ON position, the symbols shown below will light up. If these symbols remain on or malfunction, we recommend having the vehicle inspected by an authorized Kia dealer/service partner.

The information provided may differ according to which functions are applicable to your vehicle.

Symbol	Time	Notes
	Continuously	Ready indicator appears when the vehicle is ready to be driven.
	Off	<ul style="list-style-type: none"> Normal driving is not possible, or a problem has occurred.
	Blinking	<ul style="list-style-type: none"> Emergency driving, there is a problem with the system.
	6 seconds	Service warning light appears for approximately 3 seconds and then goes off.
	Continuously	<ul style="list-style-type: none"> When there is a problem with related parts of the electric vehicle control system, such as sensors, etc.
	3 seconds	Power down indicator light appears for approximately 3 seconds.
	Continuously	<ul style="list-style-type: none"> The high voltage battery level is too low or voltage is decreasing The temperature of the high voltage battery is too high or too low The temperature of the motor is high
	Continuously	Charging indicator light appears when the charging connector is connected to charge the high voltage battery.
	Continuously	High voltage battery level warning light appears when the high voltage battery level is low. When the warning light turns ON, charge the battery immediately.
	3 seconds	Charging system warning light appears for approximately 3 seconds and then goes off.
	Continuously	<ul style="list-style-type: none"> Whenever there is a malfunction with either the LDC (Low DC-DC converter) or electrical charging system.
	Continuously	Seat belt warning light informs the driver that the seat belt is not fastened. Refer to "Seat belts" on page 4-11.
	6 seconds	The air bag warning light appears for about 6 seconds and then turns off.
	Continuously	<ul style="list-style-type: none"> There is a malfunction with the Safety Restraint System (SRS) air bag operation.
	3 seconds	Parking brake & brake fluid warning light appears for approximately 3 seconds.
	Continuously	<ul style="list-style-type: none"> Red: When the parking brake is applied. Red: When the brake fluid level in the reservoir is low. Red: When the regenerative brake does not operate. Yellow: Regenerative brake warning light appears when the regenerative brake does not operate and the brake does not perform well.
	3 seconds	The ABS warning light appears for about 3 seconds and then goes off.
	Continuously	<ul style="list-style-type: none"> Whenever there is a malfunction with the ABS.
	Continuously	Electronic Brake Force Distribution (EBD) system warning light appears when there is a problem with the Electronic Brake Force Distribution system.
		3 seconds
	Continuously	<ul style="list-style-type: none"> Whenever there is a malfunction with the electric power steering.
	Continuously	Master warning light appears when there is a malfunction in various vehicle functions. To identify the details of the warning, refer to the LCD display warning message.
EPB	3 seconds	Electronic Parking Brake EPB warning light appears for about 3 seconds and then goes off.
	Continuously	<ul style="list-style-type: none"> Whenever there is a malfunction with the Electronic Parking Brake EPB

Symbol	Time	Notes
	3 seconds	Low tire pressure warning light appears for approximately 3 seconds and then goes off.
	Continuously	<ul style="list-style-type: none"> When one or more of your tires are significantly underinflated.
	Blinking	<ul style="list-style-type: none"> When there is a malfunction with the TPMS. Refer to "Tire Pressure Monitoring System (TPMS) (if equipped)" on page 7-5.
	3 seconds	Forward Safety warning light appears for approximately 3 seconds and then goes off.
	Continuously	<ul style="list-style-type: none"> Yellow: When Forward Collision-Avoidance Assist is Off/Disabled/Malfunction. Refer to "Forward Collision-Avoidance Assist (FCA) (Sensor Fusion) (if equipped)" on page 6-34.
	Blinking	<ul style="list-style-type: none"> Red: When Forward Collision-Avoidance Assist is operating Refer to "Forward Collision-Avoidance Assist (FCA) (Sensor Fusion) (if equipped)" on page 6-34.
	Continuously	Lane safety indicator light appears: <ul style="list-style-type: none"> Green: When Lane Keeping Assist operating conditions are satisfied. White: When Lane Keeping Assist operating conditions are not satisfied. Yellow: Whenever Lane Keeping Assist is off or there is a malfunction with Lane Keeping Assist. Refer to "Lane Keeping Assist (LKA) (if equipped)" on page 6-45.
	Continuously	Lane Following Assist indicator light appears: <ul style="list-style-type: none"> Green: When Lane Following Assist is activated Gray: When Lane Following Assist operating conditions are not satisfied Refer to "Lane Following Assist (LFA) (if equipped)" on page 6-83.
	3 seconds	LED headlight warning light appears for approximately 3 seconds and then goes off.
	Continuously	<ul style="list-style-type: none"> Whenever there is a malfunction with the LED headlight.
	Blinking	<ul style="list-style-type: none"> Whenever there is a malfunction with a LED headlight related part.
	Continuously	Icy road warning light and outside temperature gauge blinks and then appears. Also, the warning chime sounds 1 time.
	3 seconds	Electronic Stability Control indicator light appears for about 3 seconds and then goes off.
	Continuously	<ul style="list-style-type: none"> Whenever there is a malfunction with ESC system.
	3 seconds	The ESC OFF indicator light appears for approximately 3 seconds and then goes off.
	Continuously	<ul style="list-style-type: none"> When you deactivate ESC system by pressing the ESC OFF button. Refer to "Electronic Stability Control (ESC)" on page 6-28.
	Continuously	When the vehicle detects the smart key in the vehicle in ACC/ON position
	Blinking	When the key is not in the vehicle Whenever there is a malfunction with the immobilizer system.
	2 seconds	When the vehicle cannot detect the smart key.
	Blinks	When the turn signal light is on
	Continuously	When high-beam headlamps are on.
	Continuously	When low-beam headlamps are on.
	Continuously	When the light switch is in the ON position
	Continuously	When the front fog lights are on.
	Continuously	When the rear fog lights are on.
	Continuously	When HBA is activated.
AUTO HOLD	Continuously	When AUTO HOLD is activated.

Symbol	Time	Notes
ECO ECO+ SPORT	Continuously	When you select each mode as drive mode. Refer to "Drive mode integrated control system" on page 6-31.

*** INFORMATION**

• **Dual-diagonal braking system**

Your vehicle is equipped with dual diagonal braking systems. This means you still have braking on two wheels even if one of the dual systems should fail.

With only one of the dual systems working, more than normal pedal travel and greater pedal pressure are required to stop the vehicle. Also, the vehicle will not stop in as short a distance with only a portion of the brake system working.

• **Ready Indicator** 

When the ready indicator goes OFF or blinks, there is a problem with the system. In this case, Kia recommend that you have your vehicle inspected by an authorized Kia dealer/service partner.

▲ WARNING

• **Parking brake & brake fluid warning light** 

- Driving the vehicle with a warning light ON is dangerous. If the parking brake & brake fluid warning light appears with the parking brake released, it indicates that the brake fluid level is low.
- In this case, have the vehicle inspected by a professional workshop. Kia recommends visiting an authorized Kia dealer/service partner.

• **Electronic Brake force Distribution (EBD) system warning light** 

- When both ABS and parking brake & brake fluid warning lights are on, the brake system will not work normally and you may experience an unexpected and dangerous situation during sudden braking.
- In this case, avoid high speed driving and abrupt braking. We recommend you have the vehicle inspected by an authorized Kia dealer/service partner as soon as possible.

• **Safe stopping**

- The TPMS cannot alert you to severe and sudden tire damage caused by external factors.
- If you notice any vehicle instability, immediately take your foot off the accelerator pedal, apply the brakes gradually with light force, and slowly move to a safe position off the road.

*** NOTICE**

- Make sure that all warning lights are OFF after starting the vehicle. If any light is still ON, this indicates a situation that needs attention.
- **Power down indicator light** 
 - Do not accelerate or start the vehicle suddenly when the power down indicator light is ON.

When the power is limited for the safety of the high-powered parts of an electric vehicle, the power down

indicator light appears. Your vehicle may not be driven, or may roll back on a slope with the indicator light ON.

- **Electronic Brake force Distribution (EBD) system warning light** 
 - When the ABS warning light is on or both ABS and Parking Brake & Brake Fluid warning lights are on, the speedometer, odometer, or trip-meter may not work. Also, the MDPS warning light may appear and the steering effort may increase or decrease.
 - In this case, avoid high speed driving and abrupt braking. We recommend you have the vehicle inspected by an authorized Kia dealer/service partner as soon as possible.
 - The Electronic Parking Brake **EPB** warning light may appear when the Electronic Stability Control (ESC) indicator light comes on to indicate that the ESC is not working properly (This does not indicate malfunction of the EPB).
 - Continuous driving with the LED Headlight warning light on or blinking can reduce LED headlight life.
 - If the icy road warning light appears while driving, you should drive more attentively and safely refraining from over-speeding, rapid acceleration, sudden braking or sharp turning, etc.
-

Lighting

Battery saver function

Operation

- The position lamp will turn off automatically.

Operating condition(s)

- The vehicle is off and the driver's door is opened.

* INFORMATION

- However, the position lamps stay ON even when the driver side door is opened if the light switch is operated after the vehicle is turned off.
 - If necessary, to keep the lamps on turn the position lamps OFF and ON again using the headlamp switch on the steering column after the vehicle is turned off.
-

▲ CAUTION

To prevent the battery from being discharged, do not leave the headlight and interior light on for a prolonged time while the vehicle is not running.

Headlamp escort function

Operation

- The headlamps remain on for approximately 5 minutes if the vehicle is in ACC or OFF position with the headlamps ON.
- The headlamps turn off after 15 seconds if The driver door is opened and closed.

- To turn the headlamps OFF:
 - Press the lock button on the key twice
 - Turn the headlamp switch to OFF position

Operating condition(s)

- The vehicle is in ACC or OFF position with the headlamps ON
- The driver's door is opened and closed

Daytime Running Light (DRL)

Operating condition(s)

- The vehicle is in the ON position
- The headlamp switch is in the OFF position
- The parking brake is disengaged

Traffic change (For Europe)

The distribution of light from low-beam headlamps is asymmetrical. If you go to a country with opposite traffic direction, this asymmetrical distribution will dazzle drivers in oncoming vehicles. To avoid dazzling other drivers, ECE regulations require various technical solutions (e.g., automatic change system, adhesive sheet, downward aim). This vehicle's headlamps are designed not to dazzle oncoming drivers. Thus, you need not change your headlamps when in a country with opposite traffic direction.

Lighting controls

Operating lights

Type A



Type B



Type C



5

Operation

- 1 OFF (O)
- 2 AUTO
 - The headlamps and tailamps will turn ON or OFF automatically depending on the external ambient light level.
- 3 Position & Taillamp (☞☞)
- 4 Low beam (☞D)

*** INFORMATION**

The vehicle must be in the ON position to turn on the headlights.

⚠ CAUTION

- Never place anything over the sensor located on the instrument cluster as this will ensure better auto-light system control.
- Don't clean the sensor using a window cleaner, the cleaner may leave a light film which could interfere with sensor operation.
- If your vehicle has window tint or other types of metallic coating on the front windshield, the Auto light system may not work properly.

Operating turn signals



Operation

- Move the lever up or down (A).

*** NOTICE**

If an indicator flash is abnormally quick or slow, a bulb may be burned out or have a poor electrical connection in the circuit.

One-Touch Lane-Change function

Operation

- Move the turn signal lever up or down (B).
- Release the lever.

*** INFORMATION**

- You can activate or deactivate the One Touch Turn Signal function or choose the number of blinking (3, 5, or 7) by selecting **Lights → One Touch Turn Signal** from the Settings menu.
- The infotainment system may change after software updates. For more information, refer to the manual provided in the infotainment system and the quick reference guide.
- If an indicator stays on and does not flash or if it flashes abnormally, one of the turn signal bulbs may be burned out and will require replacement.

Operating fog lights (if equipped)



Operation

- Turn the fog light switch (1) to the dedicated position.
- Rear: (Ⓡ)

Operating condition(s)

- The headlamps are turned ON.

⚠ CAUTION

When in operation, the fog lights consume large amounts of vehicle electrical power. Only use the fog lights when visibility is poor.

Operating high beam

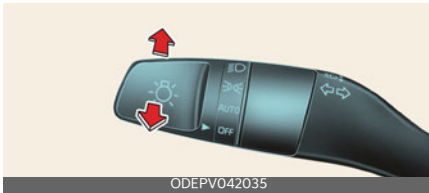

Operation

- Push the lever to use high beam.
- Pull the lever towards you to flash the headlights (HID).

⚠ WARNING

Do not use high beam when there are other vehicles. Using high beam could obstruct the other driver's vision.

*** NOTICE**

- If you push the lever away from you, the lever will return to its original position. The high beam indicator will light when the headlight high beams are switched on.
- It will return to the normal (low beam) position when released after pulling the lever towards you. The headlight switch does not need to be on to use this flashing feature.

High Beam Assist (HBA) (if equipped)



High Beam Assist is a function that automatically adjusts the headlamp range (switches between high beam and low beam) according to the brightness of other vehicles and road conditions.

Operating condition

1. Place the light switch in the AUTO position.
2. Turn on the high beam by pushing the lever away from you.
3. High Beam Assist (HBA) indicator will appear.
4. High Beam Assist will turn on when vehicle speed is above 40 km/h (25 mph).
5. The details of operation with the light switch while High Beam Assist is on are below.
 - 1) If the light switch is pushed away, High Beam Assist will turn off and the high beam will be on continuously.
 - 2) If the light switch is pulled towards you when the high beam is off, the high beam will be on without cancellation of High Beam Assist. (When you take your hands off the switch the lever will move to the middle and the high beam will turn off.)
 - 3) If the light switch is pulled towards you when the high beam is on by High Beam Assist, the low beam will

be on and High Beam Assist will turn off.

- 4) If the light switch is turned to the headlamp position (☞) from AUTO position, High Beam Assist will turn off and the low beam will be on continuously.

When High Beam Assist is operating, the high beam switches to low beam in the below conditions.

- When the headlamp is detected from the oncoming vehicle.
- When the tail lamp is detected from the front vehicle.
- When headlamp/tail lamp of bicycle/motorcycle is detected.
- When the surrounding is so bright that high beams are not needed.
- When streetlights or other lights are detected.
- When the light switch is not in the AUTO position.
- When vehicle speed is below 30 km/h (19 mph).

Warning light and message

When High Beam Assist is not working properly, a warning message (**Check High Beam Assist (HBA) system**) will come on for a few second. After the message disappears, the master warning light (▲) will appear.

Have the function checked by a professional workshop. Kia recommends to visit an authorized Kia dealer/service partner.

▲ CAUTION

The driver must be cautious in the below situations as the function may not operate in the following conditions:

When the light from on-coming or front vehicle is poor

- When the light from the oncoming or front vehicle is not detected because of lamp damage, or because it is hidden from sight, etc.
- When the lamp of the oncoming or front vehicle is covered with dust, snow or water.
- When the front vehicle's headlamps are off but the fog lamps on and etc.

When external conditions intervene

- When there is a lamp that has a similar shape as a vehicle's lamps.
- When the headlamp is not repaired or replaced at an authorized dealer
- When headlamp aiming is not properly adjusted.
- When driving on a narrow curved road, rough road, downhill or uphill.
- When only part of the vehicle in front is visible on a crossroad or curved road.
- When there is a traffic light, reflecting sign, flashing sign or mirror ahead.
- When there is a temporary reflector or flash ahead (construction area).
- When the road conditions are bad such as being wet, iced or covered with snow.
- When a vehicle suddenly appears from a curve.
- When the vehicle is tilted from a flat tire or being towed.
- When the Lane Safety indicator (yellow) appears (if equipped) and etc.

When front visibility is poor

- When the lamp of the oncoming or front vehicle is covered with dust, snow or water.
- When the light from the oncoming or front vehicle is not detected because of exhaust fume, smoke, fog, snow, etc.
- When the front window is covered with foreign matters.
- When it is hard to see because of fog, heavy rain or snow and etc.
- Do not disassemble a front view camera temporarily for tinted window or attaching any types of coatings and accessories. If you disassemble the camera and assemble it again, have the function checked by a professional workshop. Kia recommends to visit an authorized Kia dealer/service partner and have the function checked to need a calibration.
- When you replace or reinstall the windshield glass, or front view camera, have the function checked by a professional workshop. Kia recommends to visit an authorized Kia dealer/service partner.
- Be careful that water doesn't get into High Beam Assist unit and do not remove or damage related parts of High Beam Assist.
- Do not place objects on the crash pad that reflect light such as mirrors, white paper, etc. The function may not be able to function if sunlight is reflected.
- At times, High Beam Assist may not operate due to function limitations. The function is for your convenience only. It is the responsibility of the driver for safe driving practices and always check the road conditions for your safety.

- When the function does not operate normally, change the lamp position manually between the high beam and low beam.

Headlamp leveling adjustment switch (if equipped)



Operation

- The higher the number of the switch position is, the lower the headlight beam level.
- Always keep the headlamp beam at the proper leveling position, or your headlamps may dazzle other road users.

Loading condition	Switch position
Driver only	0
Driver + Front passenger	0
Full set of passengers (including driver)	1
Full set of passengers (including driver) + Maximum permissible loading	2
Driver + Maximum permissible loading	3

Wipers and washers

Wipers

Controlling the wipers

Type A



Type B



Type C



Operation

- 1 Front wiper speed control
 - MIST (1x): Single wipe
 - OFF (0): Off
 - INT (---): Intermittent control wipe
 - LO (1): Low wiper speed
 - HI (2): High wiper speed
- 2 Rear wiper speed control
 - HI (2): Continuous wipe
 - LO (1): Intermittent wipe
 - OFF (0): Off

Washers

Controlling washers

Type A



Type B



Type C



Operation

1. Move the wiper speed control switch to OFF (0) position.
2. Pull the lever gently toward you to spray washer fluid on the windshield.
3. Operate the wipers so they perform several cycles.

WARNING

Do not use the washer in freezing temperatures without first warming the windshield with the defrosters; the washer solution could freeze on the windshield and obscure your vision.

⚠ CAUTION

- When the START/STOP button is in ON position and the windshield wiper switch is placed in the AUTO mode, use caution in the following situations to avoid any injury to the hands or other parts of the body:
 - Do not touch the upper end of the windshield glass facing the rain sensor.
 - Do not wipe the upper end of the windshield glass with a damp or wet cloth.
 - Do not put pressure on the windshield glass.
- When washing the vehicle, set the wiper switch in the OFF (0) position to stop the auto wiper operation.
The wiper may operate and be damaged if the switch is set in the AUTO mode while washing the vehicle.
- Do not remove the sensor cover located on the upper end of the driver or passenger side windshield glass. Damage to system parts could occur and may not be covered by your vehicle warranty.
- When starting the vehicle in winter, set the wiper switch in the OFF (0) position. Otherwise, wipers may operate and ice may damage the windshield wiper blades. Always remove all snow and ice and defrost the windshield properly prior to operating the windshield wipers.
- When tinting the windshield, be careful of any fluid getting into the sensor located in the top center of the front windshield. It may damage the related parts.
- To prevent possible damage to the washer pump, do not operate the

washer when the fluid reservoir is empty.

- To prevent possible damage to the wipers or windshield, do not operate the wipers when the windshield is dry.
- To prevent damage to the wiper blades, do not use gasoline, kerosene, paint thinner, or other solvents on or near them.
- To prevent damage to the wiper arms and other components, do not attempt to move the wipers manually.
- To prevent possible damage to the wipers and washer system, use anti-freezing washer fluids in the winter season or cold weather.

*** NOTICE**

If there is heavy accumulation of snow or ice on the windshield, defrost the windshield for about 10 minutes, or until the snow and/or ice is removed before using the windshield wipers to ensure proper operation. If you do not remove the snow and/or ice before using the wiper and washer, it may damage the wiper and washer system.

Welcome system (if equipped)

The surroundings or the interior will be lit up when the driver approaches or exits the vehicle.

Door handle lamp



Operation

- Door handle lamp will turn on for approximately 15 seconds.

Operating condition(s)

- All the doors (and tailgate) are closed and locked.

Headlamp escort function

Operation

- The headlamps remain on for approximately 5 minutes if the vehicle is in ACC or OFF position with the headlamps ON.
- The headlamps turn off after 15 seconds if the driver door is opened and closed.

Operating condition(s)

- Vehicle is in the ACC position.
- The driver door is opened and closed.

Interior lighting

Operation

- The room lamp will turn on.
 - For approximately 30 seconds.

Operating condition(s)



- The map lamp switch is in DOOR mode.
- All the doors (and tailgate) are closed and locked.

Interior lights

Map lamp



Operation

- Press or touch the lamp (1) to turn the map lamp ON.
-  (2): DOOR mode
-  (3): Front and rear room lamps on and off.

* INFORMATION

DOOR mode

- The map lamp and room lamp come on approximately 30 seconds.
 - When a door is opened.
 - When doors are unlocked with a smart key as long as the doors are not opened.
- The map lamp and room lamp will stay on
 - If a door is opened with the vehicle in the ACC or OFF position. (5 minutes)
 - If the door is opened with the vehicle in the ON position. (continuously)
- The map lamp and room lamp will go out
 - If the vehicle is changed to the ON position or all doors are locked. (immediately)

* NOTICE

The DOOR mode and ROOM mode can not be selected at a time.

Room lamp (if equipped)



Operation

- Press the switch to turn the room lamp on and off.

Luggage room lamp

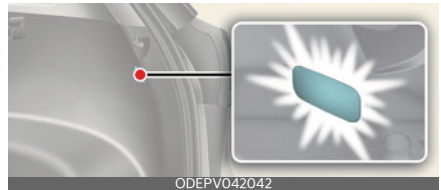

Operation

- Open the tailgate. The lamp will turn on.

Vanity mirror lamp (if equipped)



Operation

- ☀️: The lamp will turn on if this button is pressed.
- ⊙: The lamp will turn off if this button is pressed.

* NOTICE

To prevent unnecessary charging system drain, close the vanity mirror cover after using the mirror.

Climate control system

Climate control system components

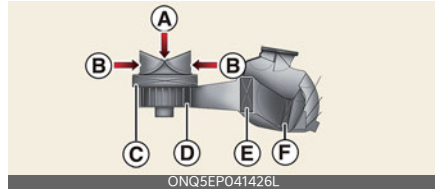

- A: Outside air
- B: Recirculated air
- C: Climate control air filter
- D: Blower
- E: Evaporator core
- F: Heater core

The climate control air filter installed behind the front trunk filters the dust or other pollutants that come into the vehicle from the outside through the heating and air conditioning system.

If dust or other pollutants accumulate in the filter over a period of time, the air flow from the air vents may decrease. This leads to moisture accumulating on the inside of the windshield even when the outside (fresh) air position is selected.

If this happens, have the climate control air filter replaced by a professional workshop. Kia recommends visiting an authorized Kia dealer/service partner.

Air conditioning refrigerant label

Example Type A



Example Type B



- 1 Classification of refrigerant
- 2 Amount of refrigerant
- 3 Classification of Compressor lubricant
- 4 Caution
- 5 Flammable Refrigerant
- 6 A registered technician must service the air conditioning system
- 7 Service manual

You can find out which air conditioning refrigerant is applied your vehicle at the label inside of the motor room.

Refer to "Refrigerant label" on page 9-8 for more detail on the location of air conditioning refrigerant label.

⚠ WARNING

- **Vehicles equipped with R-134a**



Because the refrigerant is at very high pressure, the air conditioning system should only be serviced by trained and certified technicians. It is important that the correct type and amount of oil and refrigerant is used. Otherwise, it may cause damage to the vehicle and personal injury.

- **Vehicles equipped with R-1234yf***



Since the refrigerant is mildly flammable and operated at high pressure, the air conditioning system should only be serviced by trained and certified technicians.

It is important that the correct type and amount of oil and refrigerant are used. All refrigerants should be reclaimed with proper equipment. Venting refrigerants directly to the atmosphere is harmful to individuals and environment. Failure to heed these warnings can lead to serious injuries.

⚠ CAUTION**• AC repair**

It is important that the correct type and amount of oil and refrigerant is used, otherwise, damage to the vehicle may occur. To prevent damage, the air conditioning system in your vehicle should only be serviced by trained and certified Kia technicians.

- The air conditioning system should only be used with the windows and sunroof closed to prevent condensation inside the vehicle that may cause damage to electrical components.
-

*** NOTICE**

- Replace the filter according to the maintenance schedule. If the vehicle is being driven in severe conditions such as dusty or rough roads, more frequent air conditioner filter inspections and changes are required.
 - When the air flow rate suddenly decreases, have the system checked by a professional workshop. Kia recommends visiting an authorized Kia dealer/service partner.
-

Automatic climate control system



- 1 Temperature control knob
- 2 **AUTO** (automatic control) button
- 3 Front windshield defroster button
- 4 Rear window defroster button
- 5 Air conditioning **A/C** button
- 6 Air intake control button
- 7 OFF button
- 8 Fan speed control knob
- 9 Mode selection button
- 10 Climate button
- 11 Driver only select button
- 12 **HEAT** button

Operating the climate control system

Left-hand drive

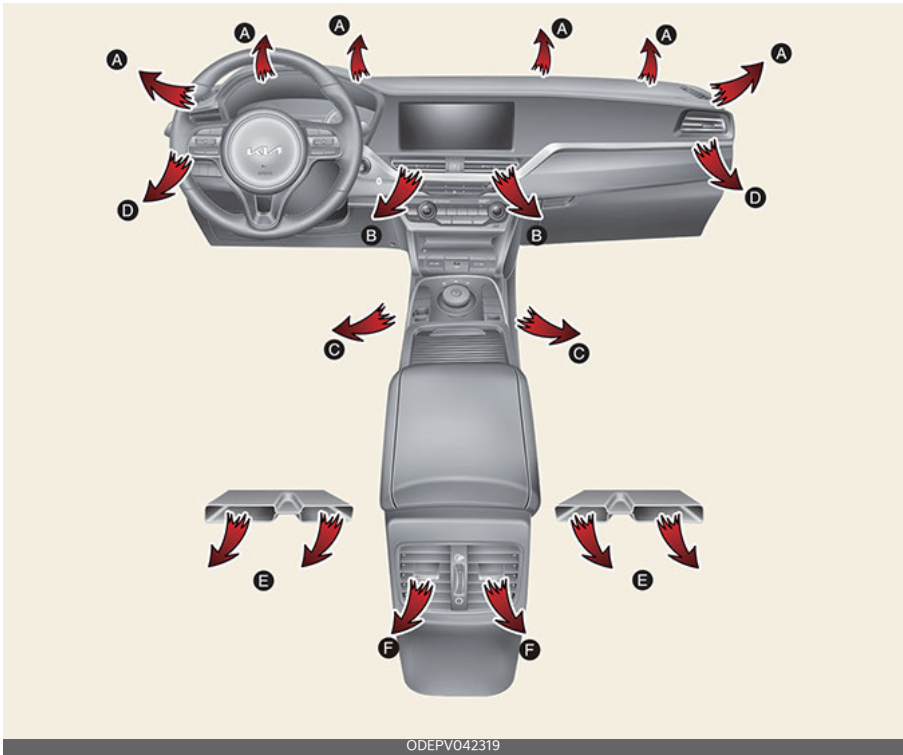

Right-hand drive

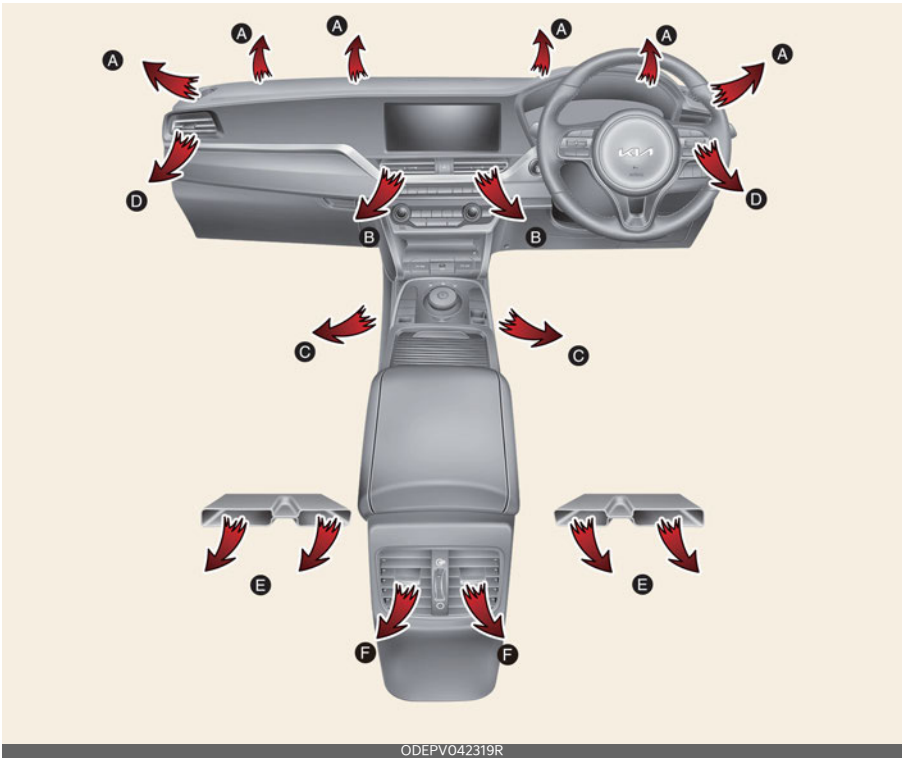

5

Mode	Operation	Air flow
	Air flow is directed toward the upper body and face.	B, D, F
	Air flow is directed towards the face and the floor.	B, C, D, E, F
	Air flow is directed toward the face, the floor and the windshield.	A, B, C, D, E, F
	Most of the air flow is directed to the floor, with a small amount of air directed to the windshield, side-window defrosters, and side air vents.	A, C, D, E
	Most of the air flow is directed to the floor and the windshield, with a small amount directed to the side-window defrosters and side air vents.	A, C, D, E
	Most of the air flow is directed to the windshield, with a small amount of air directed to the side-window defrosters and side air vents.	A, D

Operation

1. Start the vehicle.
2. Set the mode-selection buttons as desired. To improve the effectiveness of heating and cooling:
 - Heating: (☀️)
 - Cooling: (❄️)
3. Set the temperature control to the desired temperature level.
4. Set the air intake control to the position for outside (fresh) air if required.
5. Set the position of the fan speed control so that it runs at the desired speed.
6. If desired, turn the air conditioning ON with the temperature set high in order to dehumidify the air before it enters into the cabin.
If the windshield fogs up, select the Front Defrost (👤) mode.

Selecting air flow modes



Operation

- Select the direction of the air flow through the ventilation system.
- The air flow outlet ports are enabled in the following sequence:



Controlling the air intake



Operation

- Select the outside (fresh) air position or recirculated air position.
- Outside (fresh) air position: Air enters the vehicle from outside. The indicator light will turn off.
- Recirculated air position: Air from the passenger compartment will be drawn back into the heating system. The indicator light appears.

Controlling the vents

Front/Center (if equipped)

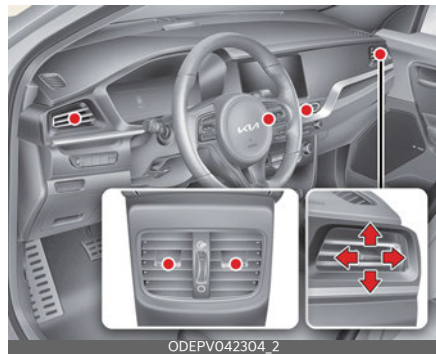

Operation

- Adjust the direction of air delivered from the vents.

Air conditioning A/C

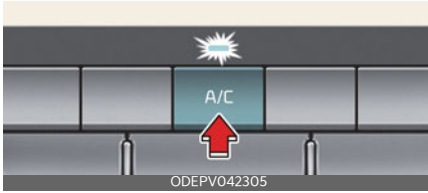

Operation

- Press the **A/C** button.

Controlling heating and air conditioning automatically



Operation

1. Set the desired temperature.
2. Press the **AUTO** button to control:
 - Mode
 - Fan speed
 - Air intake
 - Air conditioning

Controlling the temperature

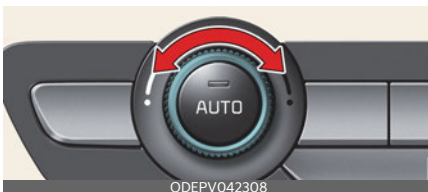

Operation

- Turn the knob left or right to the desired temperature.

Driver only mode



Operation

1. Press the **DRIVER ONLY** button.
2. The air will mostly blow in the direction of the driver's seat area.

Changing temperature scale

Operation

- While pressing the **OFF** button, press and hold the **AUTO** button for more than 3 seconds.
- The display will change from °C to °F, or from °F to °C.

* INFORMATION

If the battery has been discharged or disconnected, the temperature mode display will reset to Centigrade.

Controlling fan speed

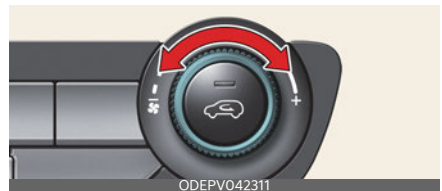

Operation

- Turn the knob left or right to adjust the speed.

Climate information screen selection (if equipped)

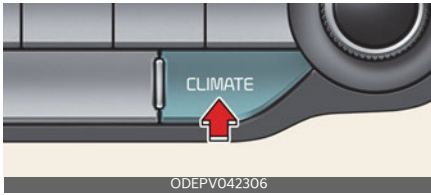

Operation

- Press the climate information screen selection button to display climate information on the screen.

Heat button



Operation

- Electric vehicle uses a PTC heater to control the heating of the vehicle.
- If you press the button manually to turn off the function, only the ventilation function works.
- To turn on the PTC heater when the HEAT button indicator is OFF, press the HEAT button (indicator ON) and set the desired temperature.

* PTC: Positive Temperature Coefficient

⚠ WARNING

- Do not use the (🌀) or (🌀) position during cooling operation in extremely humid weather. The difference between the temperature of the outside air and the windshield could cause the outer surface of the windshield to fog up, causing loss of visibility. In this case, set the mode selection to the (🌀) position and fan speed control to the lower speed.
- Continued use of the climate control system operation in Recirculation mode for a prolonged period of time may cause drowsiness to the occupants in the cabin. This may lead to loss of vehicle control which may lead to an accident.
- Continued use of the climate control system operation in Recirculation mode with the air conditioning OFF may allow humidity to increase inside the cabin. This may cause condensation to accumulate on the windshield and obscure visibility.
- Do not sleep in your vehicle or remain parked in your vehicle with the windows up and either the heater or the air conditioning ON for prolonged periods of time. Doing so may increase the levels of carbon dioxide in the cabin which may lead to serious injury or death.

⚠ CAUTION

To prevent damage to the conductors bonded to the inside surface of the rear window, never use sharp instruments or window cleaners containing abrasives to clean the window.

* NOTICE

- When the air conditioning is turned on by Auto defogging system, if you try to turn off the air conditioning, the air conditioning will not be turned off.
- To maintain the effectiveness and efficiency of the Auto Defogging System, do not select Recirculation mode while the system is operating.
- When the Auto Defogging System is operating, the fan speed adjustment knob, the temperature adjustment knob, and the air intake control button are all disabled.
- Do not remove the sensor cover located on the upper end of the driver side windshield glass.
Damage to system parts could occur and may not be covered by your vehicle warranty.
- If the battery (12V) is discharged or disconnected, Auto dehumidify settings will be reset. Readjust the settings to turning Auto dehumidify option ON or OFF.
- The infotainment system may change after software updates. For more information, refer to the manual provided in the infotainment system and the quick reference guide.

OFF mode

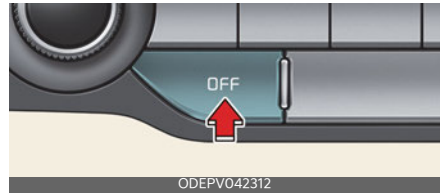

Operation

- Press the front blower OFF button to turn off the front air climate control system.

⚠ WARNING

- Continuously using the climate control system in the recirculated air position may fog the glass, obscure visibility and make the air in the passenger compartment stale.
- Do not sleep in a vehicle with the air conditioning or heating system on. It may cause serious harm or death due to a drop in the oxygen level and/or body temperature.
- Continuously using the climate control system in the recirculated air position can cause drowsiness or sleepiness, and loss of vehicle control. Set the air intake control to the outside (fresh) air position as much as possible while driving.

⚠ CAUTION

Operating the blower when the START/STOP button is in the ON position could cause the battery to discharge. Operate the blower when the vehicle is running.

* NOTICE

- Prolonged use of the air conditioning with the re circulated air position selected will result in excessively dry air in the passenger compartment.
- To turn the automatic operation off, select any button or switch of the following:
 - Mode selection button
 - Air conditioning button
 - Front-windshield defroster button (Press the button one more time to deselect the front windshield defroster function. The AUTO sign will illuminate on the information display once again.)
 - Fan speed control knob

The selected function will be controlled manually while other functions operate automatically.

- For your convenience and to improve the effectiveness of the climate control, use the AUTO button and set the temperature to 22 °C (72 °F).
- Never place anything over the sensor located on the instrument panel to ensure better control of the heating and cooling system.
- To help improve microphone voice input sound, fan speed may automatically slow down for a couple of minutes when you activate voice recognition or hands free.

- When charging or right after charging the high voltage battery, the cooling will be made using air conditioner system in order to control the high voltage battery temperature.
At this time, the noise might occur by the air conditioner compressor and cooling fan, but this is due to normal operation.
-

Windshield defrosting and defogging

Defrosting/defogging the windshield



Operation

1. Set the fan speed to the desired position.
2. Select the desired temperature.
3. Select (🌀) or (🌀).
4. Outside (fresh) air and air conditioning will be selected automatically.

Rear window/outside mirror defroster



Operation

- Press the Rear-window defroster button. The indicator lights up when the defroster is ON.
- It turns OFF after approximately 20 minutes or when the vehicle is in OFF position.

⚠ CAUTION

Conductors

To prevent damage to the conductors bonded to the inside surface of the rear window, never use sharp instruments or window cleaners containing abrasives to clean the window.

Auto defogging for automatic climate control



Operation

• For Europe

- Air conditioning will turn ON.
- Air intake control will change to Fresh mode.
- Mode will change to defrost to direct airflow to the windshield.
- Fan speed will increase.

• Except Europe

- Air conditioning will turn ON.
- Air intake control will change to Fresh mode.
- Fan speed will increase.
- Mode will change to defrost to direct airflow to the windshield

Operating or canceling auto defogging

Operation

- Select 'Climate → Defog/Defrost options → Auto defog' from the Settings menu.

Storage compartment

Center console storage/glove box

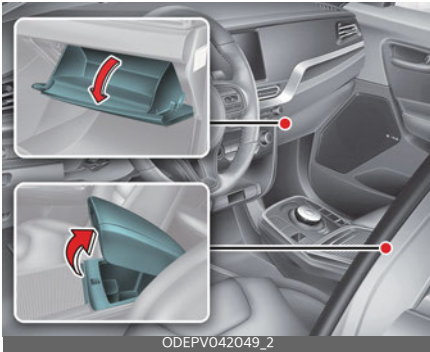

Operation

- Pull the lid upward to open the center console storage.
- Push the button of the glove box, and it will open.

⚠ WARNING

- To reduce the risk of personal injury in the event of sudden stop or collision, do not place uncovered or unsecured bottles, glasses, cans, etc., in the storage compartment while the vehicle is in motion.
- Do not store glasses, gas lighter, portable battery, canned beverage, spray can, propane cylinder, cosmetic tube or other flammable/explosive materials in the vehicle. These items may catch fire and/or explode if the vehicle is exposed to hot temperatures for extended periods.
- To reduce the risk of injury in an accident or sudden stop, always keep the glove box door closed while driving.

⚠ CAUTION

- To avoid possible theft, do not leave valuables in the storage compartment.
- Always keep the storage compartment covers closed while driving. Do not attempt to place so many items in the storage compartment that the storage compartment cover cannot close securely.
- Do not keep food in the glove box for a long time.

* NOTICE

If the armrest does not open in the event of a collision, slide the armrest from the driver's side to the passenger's side seat.

Luggage board (if equipped)



- Lift the luggage board up.
- Fold the rear luggage board to the front.

Sunglass holder



Operation

- Press the cover and the holder will slowly open.
- Push to close the holder.

Luggage net holder (if equipped)



There are 4 holders located in the cargo area.

⚠ WARNING

Avoid eye injury. DO NOT overstretch the luggage net, ALWAYS keep your face and body out of the luggage net's recoil path. DO NOT use when the strap has visible signs of wear or damage.

⚠ CAUTION

To prevent damage to the goods or the vehicle, care should be taken when carrying fragile or bulky objects in the luggage compartment.

Cargo security screen (if equipped)

Installing cargo security screen

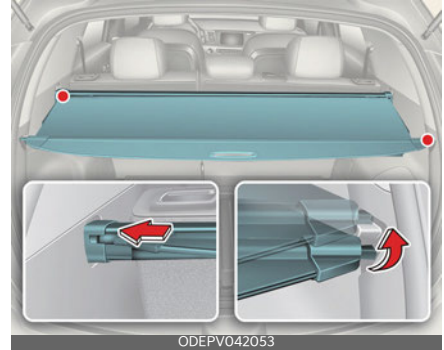

Operation

1. Pull the cargo security screen towards the rear of the vehicle by the handle.
2. Insert the guide pin into the guide.

⚠ WARNING

- Do not place objects on the cargo security screen. Such objects may move around inside the vehicle and possibly injure vehicle occupants during an accident or when braking.
- Never allow anyone to ride in the luggage compartment. It is designed for luggage only.
- Maintain the balance of the vehicle and locate the weight as forward as possible.

*** NOTICE**

- Since the cargo security screen may be damaged or malformed, do not put luggage on it when it is used.
- Pull out the cargo security screen using the handle in the center to prevent the guide pin from falling out of the guide.
- The cargo security screen may not automatically slide back in if the cargo security screen is not fully pulled out. Fully pull it out and then let go.

Removing cargo security screen



Operation

1. Push the guide pin in the direction.
2. Pull the cargo security screen out.
3. Keep the cargo security screen in the tray.

Interior features

Ambient lights (if equipped)

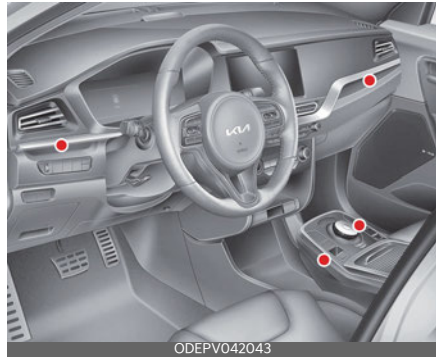

The ambient lights are installed in the front crash pad, front doors, and the top/bottom of the center console.

Cup holders

Front



Operation

- To open the cover, push the knob to the direction of the arrow (2) while pressing down the knob (1).
- To use the cup holder, press the button (1). The half part of the cup holder (2) will appear.

- Cups or small drink cans can be placed in the cup holders.

⚠ WARNING

- Do not place uncovered cups with hot liquid in the cup holder while the vehicle is in motion. If the hot liquid spills, you burn yourself. Such a burn to the driver could lead to loss of control of the vehicle.
- To reduce the risk of personal injury in the event of sudden stop or collision, do not place uncovered or unsecured bottles, glasses, cans, etc., in the cup holder while the vehicle is in motion.
- Keep cans or bottles out of direct sun light and do not put them in a vehicle that is heated up. It may explode.

*** NOTICE**

- Keep your drinks sealed while driving to prevent spilling your drink. If liquid spills, it may get into the vehicle's electrical/electronic system and damage electrical/electronic parts.
- When cleaning spilled liquids, do not dry the cup holder at high temperature. This may damage the cup holder.

Ashtray (if equipped)



Use the ashtray by putting it to the cup holder.

⚠ WARNING

Ashtray use

- Do not use the vehicle's ashtrays as waste receptacles.
- Putting lit cigarettes or matches in an ashtray with other combustible materials may cause a fire.

Seat warmer/ventilation (if equipped)

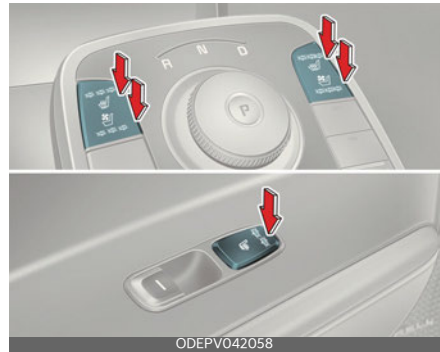

The seat warmer/ventilation is provided to warm/cool the seats.

* The seat ventilation is provided only on the front seats.

Operation

- Push either of the buttons to warm the driver's seat or the front passenger's seat.
- It defaults to the OFF position when the vehicle is in the ON position.
- The temperature setting of the seat will change as follows:

Temperature	Duration	
	Warmer	Ventilation
OFF	-	-
High	30 minutes	continuous
Medium	60 minutes	-
Low	-	continuous

⚠ WARNING

The seat warmers can cause a **SERIOUS BURN**, even at low temperatures and especially if used for long periods of time. Passengers must be able to feel if the seat is becoming too warm so they can turn it off, if needed.

Seat warmers consumes huge amount of electricity. Please avoid using seat warmers while the vehicle is off in order to prevent the battery discharge.

People who cannot detect temperature change or pain to the skin should use extreme caution, especially the following types of passengers:

- Infants, children, elderly or handi-capped persons, or hospital outpatients
- Persons with sensitive skin or those that burn easily
- Fatigued individuals
- Intoxicated individuals
- Individuals taking medication that can cause drowsiness or sleepiness (sleeping pills, cold tablets, etc.)

⚠ CAUTION

- When cleaning the seats, do not use an organic solvent such as paint thinner, benzene, alcohol and gasoline. Doing so may damage the surface of the heater or seats.
- To prevent overheating the seat warmer, do not place anything on the seats that insulates against heat, such as blankets, cushions or seat covers while the seat warmer is in operation.
- Do not place heavy or sharp objects on seats equipped with seat warmers. Damage to the seat warming components could occur.
- Do not change the seat cover. It may damage the seat warmer or air ventilation system.
- When cleaning the seats, do not use an organic solvent such as paint thinner, benzene, alcohol and gasoline. Doing so may damage the air ventilation seat.

*** NOTICE**

With the seat warmer buttons in the ON position, the heating system in the seat turns off or on automatically depending on the seat temperature.

Sun visor

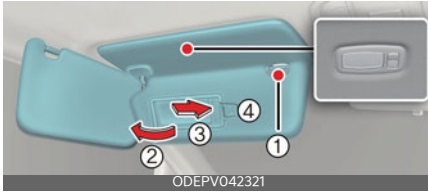

Operation

1. Pull down and unsnap it from the bracket (1).
2. Swing it to the side (2).
 - Pull down and slide the mirror cover (3) to use the vanity mirror.
 - The ticket holder (4) is provided for the purpose of holding a tollgate ticket.

⚠ WARNING

For your safety, do not block your view when using the sun visor.

*** NOTICE**

- Do not put several tickets in the ticket holder at one time. This could cause damage to the ticket holder.
- Always have the switch in the off position when the vanity mirror lamp is not in use. If the sun visor is closed without the lamp off, it may discharge the battery or damage the sun visor.

USB charger (if equipped)

Center console



Center console storage



The USB charger allows drivers and passengers to charge their digital devices such as smart phones and tablets.

⚠ CAUTION

- Use the USB car charger with the vehicle on. Otherwise, Vehicle battery can be discharged.
- Use the official USB cable of the manufacturer of the digital device to be charged.
- Make sure that any foreign object, drinks, and water do not come into contact with the USB car charger. Water or foreign object can damage the USB charger.
- Do not use the device those current consumption exceeds 2.1 A.

- Do not connect an electrical device that generates excessive electromagnetic noise to the USB car port. If you do so, noise can be caused or vehicle electronic devices can be interrupted while audio or AV is on.
- If the charger is connected incorrectly, it can cause serious damage on the devices. Please note that damages due to incorrect usage are not covered by warranty service.

Power outlet



The power outlet allows drivers and passengers to charge their digital devices such as smart phones and tablets.

Operating condition(s)

- The devices should draw less than 15 A when The vehicle is in the ON position.

⚠ WARNING

- Use the power outlet only when the vehicle is on and remove the accessory plug after use. Using the accessory plug for prolonged periods of time with the vehicle off could cause the battery to discharge.
- Only use 12 V electric accessories which are less than 15 A in electric capacity.
- Adjust the air-conditioner or heater to the lowest operating level when using the power outlet.
- Close the cover when not in use.

- Some electronic devices can cause electronic interference when plugged into a vehicle's power outlet. These devices may cause excessive audio static and malfunctions in other electronic systems or devices used in your vehicle.
- Push the plug in as far as it will go. If good contact is not made, the plug may overheat and the fuse may open.
- Plug in battery equipped electronic devices with reverse current protection. The current from the battery may flow into the vehicle's electrical/electronic system and cause system malfunction.
- Do not put a finger or a foreign object (pen, etc.) into a power outlet and do not touch with a wet hand. You may get an electric shock.

Wireless smart phone charging system (if equipped)

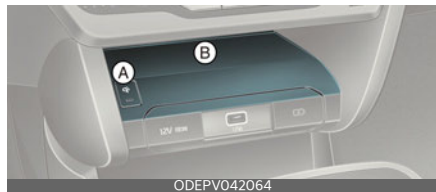

- A: Indicator
- B: Charging pad

Operation

- Place the smart phone on the center of the wireless charging pad.
- The indicator light will change to orange once the wireless charging begins.
- You can choose to turn the wireless charging function ON or OFF from the Settings menu.

Operating condition(s)

- The wireless charging system is designed for one smart phone equipped with Qi only.

* INFORMATION

- If the wireless charging does not work, gently move your smart phone around the pad until the charging indicator light turns orange. Depending on the smart phone, the charging indicator light may not turn green even after the charging is complete.
- If the wireless charging is not functioning properly, the orange light will blink and flash for ten seconds then turn off. In such cases, remove the smart phone from the pad and replace it on the pad again, or double check the charging status.
- The system warns you with a message on the instrument cluster if the smart phone is still on the wireless charging unit after the vehicle is turned OFF and the front door is opened.

⚠ WARNING

If any metallic object such as coins is located between the wireless charging system and the smart phone, the charging may be disrupted. Also, the metallic object may heat up.

⚠ CAUTION

- When the interior temperature of the wireless charging system rises above a set temperature, the wireless charging will cease to function. After the interior temperature drops below the threshold, the wireless charging function will resume.
- If there is any metallic object between the smart phone and the wireless charging pad, immediately remove the smart phone. Remove the metallic object after it has completely cooled down.
- The wireless charging may not function properly when there is a heavy accessory cover on the smart phone.
- The wireless charging will stop when using the wireless smart key search function to prevent radio wave disruption.
- The wireless charging will stop when the smart key is moved out of the vehicle with the ignition in ON.
- The wireless charging will stop when any of the doors is opened (applicable for vehicles equipped with smart keys).
- The wireless charging will stop when the vehicle is turned OFF.
- The wireless charging will stop when the smart phone is not in complete contact with the wireless charging pad.
- Items equipped with magnetic components such as credit card, telephone card, bankbook, any transportation ticket and such may become damaged during wireless charging.
- Place the smart phone on the center of the charge pad for best results. The smart phone may not charge when placed near the rim of the charging pad. When the smart phone does get charged, it may heat up excessively.
- For smart phones without built-in wireless charging system, an appropriate accessory has to be equipped.
- Smart phones of some manufacturers may display messages on weak cur-

rent. This is due to the particular characteristic of the smart phone and does not imply a malfunction on wireless charging function.

- The indicator light of some manufacturers' smart phones may still be yellow after the smart phone is fully charged. This is due to the particular characteristic of the smart phone and not a malfunction of the wireless charging.
- When any smart phone without a wireless charging function or a metallic object is placed on the charging pad, a small noise may sound. This small sound is due to the vehicle discerning compatibility of the object placed on the charging pad. It does not affect your vehicle or the smart phone in any way.
- The wireless cellular phone charging system may not support certain cellular phones, which are not verified for the Qi specification (Qi).
- For certain cellular phones with their own protection, the wireless charging speed may decrease and the wireless charging may stop.

*** NOTICE**

For some manufacturers' smart phones, the system may not warn you even though the smart phone is left on the wireless charging unit. This is due to the particular characteristic of the smart phone and not a malfunction of the wireless charging.

Coat hook

Rear grab handle



B-pillar



A coat hook is located on the rear grab handle and the B-pillar.

The B-pillar grab handle can also be used for easier access to the vehicle.

⚠ WARNING

Do not hang other objects such as hangers or hard objects except clothes. Also, do not put heavy, sharp or breakable objects in the clothing's pockets. In an accident or when the curtain air bag is inflated, it may cause vehicle damage or body injury.

⚠ CAUTION

Do not hang heavy clothes, since they may damage the hook.

Floor mat anchors

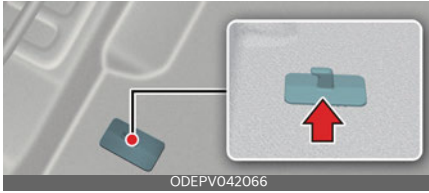

Make sure the floor mat is attached to the anchors to keep it from sliding forward.

⚠ WARNING

• After market floor mat

- Do not install after market floor mats that are not capable of being securely attached to the vehicle's floor mat anchors. Unsecured floor mats can interfere with pedal operation.
- Use floor mats not too thick and designed to be properly secured on the floor to avoid the interference with pedals. Make sure that installing the floor mats without removing plastic films on carpets may damage or break floor mat fix rings, resulting in the mats to be unsecured. Especially for a driver's seat, the unsecured mats may cause unintended acceleration/ brake. Ensure to remove all the plastic films on the carpets before installing the mats.

Audio system

Antenna

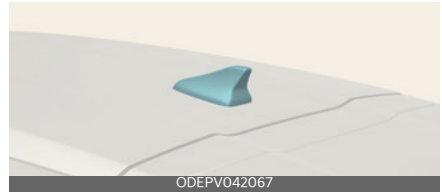

• Shark-fin Antenna

- The shark-fin antenna transmits and receives wireless signals such as AM/FM, DAB, GNSS, LTE etc.

* The signals which antenna can transmit and receive vary by the vehicle option.

⚠ CAUTION

- Be careful of antenna damage by checking the height of the vehicle before entering low-ceiling spaces such as automated parking lots or automated washing machines.
- Be careful not to contact the antenna when loading cargo on the roof rack. Antenna transmission/reception performance may be degraded.

USB port



You can use the USB port to plug in an USB.

⚠ WARNING**Cell phone use**

Do not use a cellular phone while driving. Stop at a safe location to use a cellular phone.

⚠ CAUTION

- Depending on the size, length, or shape of the USB stick, if you forcibly close the tray cover, the USB device may be damaged or deformed or the cover may not reopen as the device is stuck. When the stick is stuck, forcibly opening the cover can also cause damage to the device. If the USB stick does not fit into the space, do not close the cover and try another USB stick with different specifications.
- When using a communication system such as a cellular phone or a radio set inside the vehicle, a separate external antenna must be fitted. When a cellular phone or a radio set is used with only the internal antenna, it may interfere with the vehicle's electrical system and adversely affect the safe operation of the vehicle.

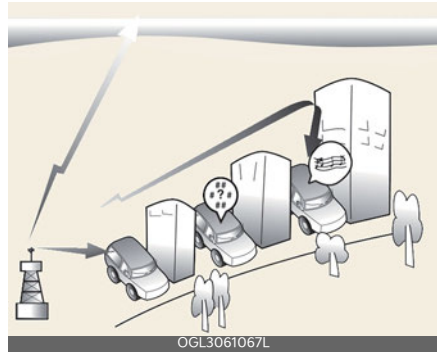
How vehicle radio works**FM reception**

AM and FM radio signals are broadcast from transmitter towers located around your city. They are intercepted by the radio antenna on your vehicle. This signal is then processed by the radio and sent to your vehicle speakers.

However, in some cases the signal coming to your vehicle may not be strong and clear.

This can be due to factors, such as the distance from the radio station, closeness of other strong radio stations or the presence of buildings, bridges or other large obstructions in the area.

AM reception

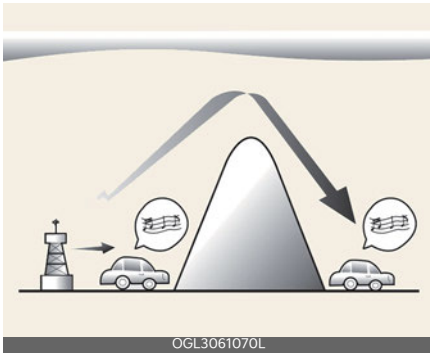

AM broadcasts can be received at greater distances than FM broadcasts. This is because AM radio waves are transmitted at low frequencies. These long distance, low frequency radio waves can follow the curvature of the earth rather than traveling straight. In addition, they curve around obstructions resulting in better signal coverage.

FM radio station

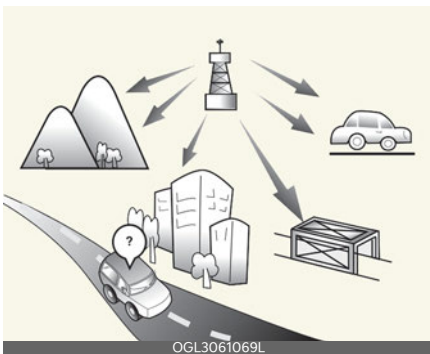

FM broadcasts are transmitted at high frequencies and do not bend to follow the earth's surface. Because of this, FM broadcasts generally begin to fade within short distances from the station. Also, FM signals are easily affected by buildings, mountains, and obstructions.

This can lead to undesirable or unpleasant listening conditions which might lead you to believe a problem exists with your radio.

The following conditions are normal and do not indicate radio trouble:

- **Fading** - As your vehicle moves away from the radio station, the signal will weaken and sound will begin to fade. When this occurs, we suggest that you select another station with a stronger signal.

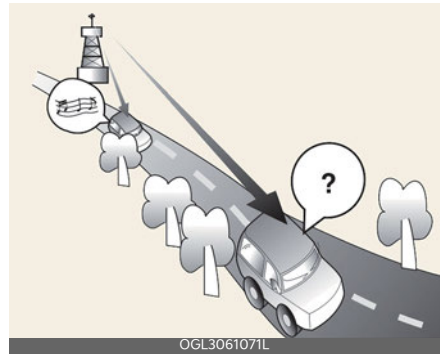

- **Flutter/Static** - Weak FM signals or large obstructions between the transmitter and your radio can disturb the signal causing static or fluttering noises to occur. Reducing the treble level may lessen this effect until the disturbance clears.
- **Station Swapping** - As an FM signal weakens, another more powerful signal near the same frequency may begin to play. This is because your radio is designed to lock onto the clearest signal. If this occurs, select another station with a stronger signal.

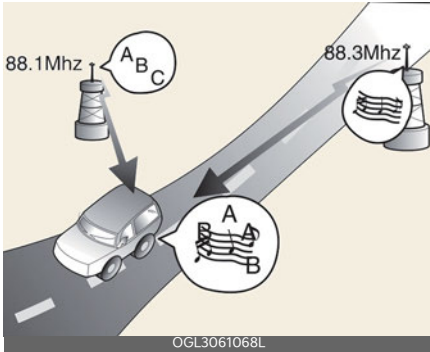

- Multi-Path Cancellation - Radio signals being received from several directions can cause distortion or fluttering. This can be caused by a direct and reflected signal from the same station, or by signals from two stations with close frequencies. If this occurs, select another station until the condition has passed.

Using a cellular phone or a two-way radio

When a cellular phone is used inside the vehicle, noise may be produced from the audio system. This does not mean that something is wrong with the audio equipment. In such a case, try to operate mobile devices as far from the audio equipment as possible.

⚠ CAUTION

When using a communication system such as a cellular phone or a radio set inside the vehicle, a separate external antenna must be fitted. When a cellular phone or a radio set is used with only the internal antenna, it may interfere with the vehicle's electrical system and adversely affect the safe operation of the vehicle.

⚠ WARNING

Cell phone use

Do not use a cellular phone while driving. Stop at a safe location to use a cellular phone.

Before driving	6-5
• Necessary vehicle inspections.....	6-5
• Good driving practices	6-5
• Good braking practices.....	6-6
Vehicle power	6-8
• Starting the vehicle.....	6-8
Reduction gear	6-10
• Changing gear.....	6-10
• Shift-lock system.....	6-11
• LCD display messages.....	6-12
Regenerative braking system	6-14
• Adjusting regenerative braking with paddle shifter	6-14
• One pedal driving	6-14
Smart regeneration system	6-15
• Operating smart regeneration system	6-15
• Smart regeneration system malfunction and limitations.....	6-16
Brake system	6-20
• In the event of brake failure.....	6-20
• Brake disc cleaning	6-20
• Parking brake	6-22
• AUTO HOLD	6-26
Vehicle safety system	6-28
• Anti-lock Brake System (ABS)	6-28
• Electronic Stability Control (ESC)	6-28
• Hill-start Assist Control (HAC)	6-29
• Vehicle Stability Management (VSM).....	6-29
• Emergency Stop Signal (ESS)	6-30
• Brake Assist System (BAS)	6-30
Drive mode integrated control system	6-31
• DRIVE MODE	6-31

6 Driving your vehicle

- DRIVE MODE characteristics 6-32
- Active air flap 6-33**
 - Active air flap malfunction..... 6-33
- Forward Collision-Avoidance Assist (FCA) (Sensor Fusion). 6-34**
 - Forward Collision-Avoidance Assist setting..... 6-34
 - Forward Collision-Avoidance Assist warning and control 6-36
 - Detecting sensors 6-37
 - Forward Collision-Avoidance Assist malfunction 6-39
 - Limitation of Forward Collision-Avoidance Assist 6-40
- Lane Keeping Assist (LKA) 6-45**
 - To activate/deactivate Lane Keeping Assist..... 6-46
 - Lane Keeping Assist settings 6-47
 - Lane Keeping Assist activation 6-47
 - Non-operating conditions of Lane Keeping Assist..... 6-49
- Blind-Spot Collision Warning (BCW)..... 6-51**
 - Blind-Spot Collision Warning setting and activation..... 6-52
 - Warning message and function control 6-53
 - Blind-Spot Collision Warning malfunction and limitations..... 6-55
- Manual Speed Limit Assist (MSLA)..... 6-58**
- Intelligent Speed Limit Warning (ISLW) 6-60**
 - Intelligent Speed Limit Warning activation/deactivation 6-61
 - Operation..... 6-61
 - Display 6-61
 - Driver's Attention..... 6-63
- Driver Attention Warning (DAW) 6-63**
 - Driver Attention Warning..... 6-63
 - Leading vehicle departure warning..... 6-66
- Cruise Control (CC)..... 6-67**
 - Cruise Control operation switches 6-67
 - To set Cruise Control speed:..... 6-68

• To increase Cruise Control set speed:	6-68
• To decrease the cruising speed:	6-68
• To temporarily accelerate with Cruise Control on:	6-68
• To cancel Cruise Control, do one of the following:	6-69
• To resume cruising speed at more than approximately 30 km/h (20 mph).....	6-69
• To turn Cruise Control off, do one of the following:.....	6-69
Smart Cruise Control (SCC)	6-70
• Smart Cruise Control operation switches.....	6-70
• Set Smart Cruise Control reaction.....	6-75
• Vehicle distance setting	6-75
• When the lane ahead is clear:	6-75
• When there is a vehicle ahead of you in your lane:.....	6-76
• To convert to Cruise Control mode:	6-78
• Detecting sensor.....	6-78
• Limitations of Smart Cruise Control.....	6-80
Lane Following Assist (LFA).....	6-83
• Lane Following Assist settings.....	6-83
• Lane Following Assist malfunction and limitations.....	6-85
Rear View Monitor (RVM)	6-88
Rear Cross-Traffic Collision Warning (RCCW)	6-89
• Setting and activating Rear Cross-Traffic Collision Warning	6-89
• Warning message and function control.....	6-90
Reverse Parking Distance Warning (PDW)	6-95
• Operation of Reverse Parking Distance Warning.....	6-96
• Non-operational conditions of Reverse Parking Distance Warning.....	6-96
• Reverse Parking Distance Warning	6-97
• Self-diagnosis	6-97
Forward/Reverse Parking Distance Warning (PDW)	6-98
• Operation of Forward/Reverse Parking Distance Warning.....	6-98

6 Driving your vehicle

- Non-operational conditions of Forward/Reverse Parking
 - Distance Warning 6-101
- Self-diagnosis 6-102
- Declaration of conformity 6-103**
- Special driving conditions 6-110**
- Winter driving 6-113**
- Vehicle weight..... 6-117**
 - Base curb weight 6-117
 - Vehicle curb weight 6-117
 - Cargo weight..... 6-117
 - GAW (Gross axle weight)..... 6-117
 - GAWR (Gross axle weight rating) 6-117
 - GVW (Gross vehicle weight) 6-117
 - GVWR (Gross vehicle weight rating) 6-117
 - Overloading..... 6-117
 - Loading Your Vehicle 6-118

Driving your vehicle

Before driving

Necessary vehicle inspections

Be sure to check the following fluid levels on a regular basis at the exact interval:

- Brake fluid
- Washer fluid

For more details, refer to "Maintenance" on page 8-3.

⚠ WARNING

Focus on the road while driving. The driver's primary responsibility is in the safe and legal operation of the vehicle. Use of any handheld devices, other equipment or vehicle systems that distract the driver should not be used during vehicle operation.

Before entering vehicle

- Be sure that all windows, outside mirrors, and outside lights are clean.
- Check the condition of the tires.
- Check under the vehicle for any sign of leaks.
- Make sure there are no obstacles behind you if you intend to back up.

Before starting the vehicle

- Close and lock all doors.
- Position the seat so that all controls are easily reached.
- Buckle your seat belt.
- Adjust both inside and outside rear view mirrors.
- Be sure that all lights work.
- Check all gauges.
- Check the operation of warning lights when the vehicle is in the ON position.

- Release the parking brake and make sure the brake warning light is off.

⚠ WARNING

- Always check the surrounding areas near your vehicle for people, especially children, before putting a vehicle into D (Drive) or R (Reverse).
- Securely store items in your vehicle. When you make a sudden stop or turn the steering wheel rapidly, loose objects may drop on the floor and it could interfere with the operation of the foot pedals, possibly causing an accident.
- Do not drive while under the influence of alcohol, drugs, or other impairing substances. Drinking and driving is dangerous. Even a small amount of alcohol will affect your reflexes, perceptions and judgment.

Driving while under the influence of drugs or other impairing substances is as dangerous as or more dangerous than driving drunk.

- Always wear appropriate shoes when operating your vehicle. Unsuitable shoes (high heels, ski boots, sandals, etc.) may interfere with your ability to use the brake and accelerator pedals.

Good driving practices

- Never shift from P or N to any other position with the accelerator pedal pressed.
- Never shift to P when the vehicle is moving.
- Stop the vehicle completely before shifting to R or D.
- Never change the gear to N and coast down the hill. This is extremely hazardous. Always make sure that the vehicle is in R or D when it is moving.

- Always use the parking brake. Do not depend on P to keep the vehicle from moving.
- Exercise extreme caution when driving on a slippery surface. Be especially careful when braking, accelerating, or shifting gears. The vehicle speed can change abruptly, causing the tires to lose traction and the vehicle to lose control.
- The risk of a rollover is greatly increased if you lose control of your vehicle at highway speeds.
- Losing control often occurs if two or more wheels drop off the roadway and the driver oversteers to reenter the roadway.
- In the event your vehicle leaves the roadway, do not steer sharply. Instead, slow down before pulling back into the travel lanes.

WARNING

- If your vehicle becomes stuck in snow, mud, sand, etc., then you may attempt to rock the vehicle free by moving it forward and backward. Do not attempt this procedure if people or objects are anywhere near the vehicle. During the rocking operation the vehicle may suddenly move forward or backward as it becomes unstuck, causing injury or damage to nearby people or objects.
- When driving uphill or downhill, always shift to D (Drive) for driving forward or shift to R (Reverse) for driving backwards, and check the gear position indicated on the cluster before driving. Driving in the opposite direction of the selected gear can lead to a dangerous situation by shutting off the vehicle and affecting the braking performance.
- ALWAYS wear your seat belt. In a collision, an unbelted occupant is significantly more likely to be seriously injured or killed than a properly belted occupant.
- Avoid high speeds when cornering or turning.
- Do not make quick steering wheel movements, such as sharp lane changes or fast, sharp turns.

- Never exceed posted speed limits.

Good braking practices

- Be sure the parking brake is not engaged and the parking brake indicator light is off before driving.
- The vehicle will not stop as quickly if the brakes are wet. Apply the brakes lightly until the braking action returns to normal.
- If you get a flat tire while driving, apply the brakes gently and keep the vehicle straight ahead while it slows down. Pull the vehicle slowly and safely off the road and stop in a safe place.
- Be cautious when parking on a hill. Firmly engage the parking brake and shift to P.
- If your vehicle is facing downhill, turn the front wheels into the curb to help keep the vehicle from rolling. If your vehicle is facing uphill, turn the front wheels away from the curb to help keep the vehicle from rolling.
- Block the wheels if there is no curb or if it is required by other conditions to keep the vehicle from rolling.

- The parking brake can freeze in the engaged position under certain conditions such as snow or ice around or near the rear brakes or if the brakes are wet.

If there is risk of the parking brake freezing, apply it only temporarily while shifting to P and block the rear wheels so that the vehicle cannot roll. Then, release the parking brake.

- Do not hold the vehicle on an incline with the accelerator pedal. This can cause the reduction gear to overheat. Always use the brake pedal or parking brake.
- Do not pump the brake pedal as the vehicle is equipped with ABS.
- The vehicle is equipped with electronic hydraulic brake. Due to malfunction or power instability, the brake booster may not operate normally and cause the brake pedal to feel stiff, resulting in longer braking distances. In this case, stop the vehicle by depressing the brake pedal stronger than usual. Have the system inspected by a professional workshop. Kia recommends visiting an authorized Kia dealer/service partner.
- The sound of electronic hydraulic brake operating or its motor may be heard temporarily when:
 - Repeatedly depressing the brake pedal
 - Opening driver's door
 - Depressing the brake pedal with the vehicle off
- In below cases, some electric brake pump noise and motor vibration may occur temporarily. This is normal operation.
 - When the pedal is pushed down very quickly

- When the pedal is pushed down multiple times in short intervals
- When the ABS function is activated during braking

* NOTICE

- When stepping on the brake pedal under a certain driving or weather condition, you may witness your car make a sound of squealing or some other noises. This is not a brake malfunction but a normal phenomenon.
- When driving on the road to which deicing chemicals are applied, the vehicle may witness noises from the brake or abnormal abrasion of tires because of such deicing chemicals. You should operate brake additionally so that you would be able to remove the deicing chemicals on the brake disk and pad under a safe traffic condition.

Vehicle power

Starting the vehicle

START/STOP button



Operation

- OFF
 - Press the START/STOP button in P to turn the vehicle off.
- ACC (Accessory)
 - Press the START/STOP button once without depressing the brake pedal.
 - The steering wheel is unlocked.
 - The electrical accessories can be operated.
 - Turns off automatically after approximately 1 hour to prevent battery discharge.
- ON
 - Press the START/STOP button twice without depressing the brake pedal.
 - The warning lights can be checked.
- START/RUN
 - Press the START/STOP button while depressing the brake pedal in P or N.
 - Start the vehicle in P for the safety.

START/STOP button interlock system

The START/STOP button will not change to the OFF position unless the vehicle is in P (Park).

Vehicles equipped with an anti-theft steering column lock

The steering wheel is locked when:

- The vehicle is in the OFF position
- The doors are opened

Starting the vehicle with smart key

The vehicle will check for the smart key when:

- The vehicle doors are opened
- The START/STOP button is pressed

If the smart key is not in the vehicle, the indicator (🔑) and the message will appear on the instrument cluster.

⚠ WARNING

- Never press the START/STOP button while the vehicle is in motion. This would result in loss of directional control and braking function, which could cause an accident.
- Before leaving the driver's seat, always make sure the gear is shifted to P (Park) position, set the parking brake fully and shut the vehicle off. Unexpected and sudden vehicle movement may occur if these precautions are not taken.
- Never reach for the START/STOP button or any other controls through the steering wheel while the vehicle is in motion. The presence of your hand or arm in the area could cause loss of vehicle control, an accident and serious bodily injury or death.

- Do not place any movable objects around the driver's seat as they may move while driving, interfere with the driver and lead to an accident.
- The vehicle will start, only when the smart key is in the vehicle. Never allow children or any person who is unfamiliar with the vehicle touch the START/STOP button or related parts. Pushing the START/STOP button while the smart key is in the vehicle may result in unintended vehicle activation and/or unintended vehicle movement.

⚠ CAUTION

- In an emergency situation while the vehicle is in motion, you are able to turn the vehicle off and to the ACC position by pressing the START/STOP button for more than 2 seconds or 3 times repeatedly within 3 seconds. If the vehicle is still moving, to restart the vehicle:
 - Press the START/STOP button when vehicle speed is over approximately 5 km/h (3 mph).
- If the vehicle is turned off while the vehicle is in motion, do not attempt to move the gear to the P (Park) position. If the traffic and road conditions permit, you may put the gear in the N (Neutral) position while the vehicle is still moving and press the START/STOP button in an attempt to restart the vehicle.
- Do not press the START/STOP button for more than 10 seconds except when the stop lamp fuse is blown.

- You can also start the vehicle when the gear is in the N (neutral) position, but for safety, be sure to start the vehicle only when the gear is in the P (Park) position.

*** NOTICE**

- If you leave the START/STOP button in the ACC or ON position for a long time, the battery will discharge.
- If you press the START/STOP button without pressing the brake pedal, the vehicle will not start and the START/STOP button changes as follow:
 - OFF → ACC → ON → OFF or ACC
- If the steering wheel doesn't unlock properly, the START/STOP button will not work. Press the START/STOP button while turning the steering wheel right and left to release the tension.
- You are able to turn off the vehicle only when the vehicle is not in motion.
- If the battery is weak or the smart key does not work correctly, you can start the vehicle by pressing the START/STOP button with the smart key. When you press the START/STOP button directly with the smart key, the smart key should contact the button at a right angle.



- When the stop lamp fuse is blown, you cannot start the vehicle normally. Replace the fuse with a new one. If it is not possible, you can start the vehicle by pressing the START/STOP button for 10 seconds while it is in the ACC position. The vehicle can start without pressing the brake pedal. But for your safety always press the brake pedal before starting the vehicle.

Reduction gear

Changing gear



Operation

- Turn the shift dial.
- Press P button to shift to P (Park).

Gear position



The indicator in the instrument cluster displays the gear position when the START/STOP button is in ON position.

Automatic shift to P (Park)

Operating condition(s)

- The driver door is opened in R (Reverse), N (Neutral), D (Drive) while vehicle is in ON position.
- The vehicle is in OFF position while the gear is in R (Reverse), N (Neutral), D (Drive).

Non-operating condition(s)

- When the vehicle is above certain speed

Shift-lock system

Shift-lock system prevents shifting the gear from P (Park) into N (Neutral)/R (Reverse)/D (Drive) or N (Neutral) into R (Reverse)/D (Drive) unless the brake pedal is depressed.

Overriding shift-lock system



Operation

1. When vehicle is in ON position, make sure the parking brake is disengaged.
2. Press AUTO HOLD button to deactivate AUTO HOLD function.
3. Shift to P (Park) and turn OFF the vehicle.
4. Depress the brake pedal and press P RELEASE button to shift to N (Neutral).

⚠ WARNING

- ALWAYS check the surrounding areas near your vehicle for people, especially children, before shifting a vehicle into D (Drive) or R (Reverse).
- Before leaving the driver's seat, always make sure the gear is in the P (Park) position, then set the parking brake, and place the Power button in the OFF position. Unexpected and sudden vehicle movement can occur if these precautions are not followed.
- Shifting into P (Park) while the vehicle is in motion may cause you to lose control of the vehicle.

- After the vehicle has stopped, always make sure P (Park) gear position is selected, apply the parking brake, and turn the vehicle off.
- Do not use the P (Park) position in place of the parking brake.
- When you park the vehicle, make sure Electronic Parking Brake is applied even though the gear is in the P (Park) position.
- If equipped with Electronic Parking Brake, parking brake is applied automatically when the gear is shifted to P (Park).

⚠ CAUTION

- Always come to a complete stop before shifting into or out of R (Reverse); you may damage the reduction gear if you shift into R (Reverse) while the vehicle is in motion, except on "Rocking the vehicle" (refer to "Rocking the vehicle" on page 6-111).
- With the exception of parking in neutral gear, always park the vehicle in P (Park) for safety and engage the parking brake.
- Before parking in N (Neutral) gear, first make sure the parking ground is level and flat. Do not park in N (Neutral) gear on any slopes or gradients. If parked and left in N (Neutral), the vehicle may move and cause serious damage and injury.

* NOTICE

- Always depress the brake pedal while shifting to another gear.
- You cannot shift the gear while the charging cable is connected.

LCD display messages

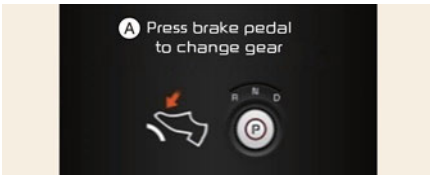
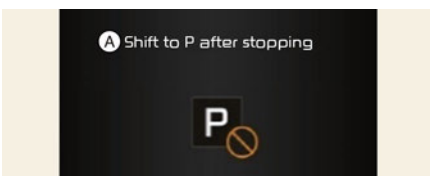
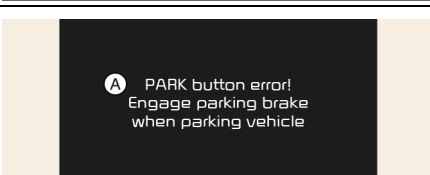
Message	Content
 <p>ODEPV052145L</p>	<p>A: Shifting conditions not met</p> <ul style="list-style-type: none"> • When driving speed is too fast to shift the gear. • When the gear is shifted while the vehicle is in Utility mode.
 <p>ODEPV052146L</p>	<p>A: Press brake pedal to change gear</p> <ul style="list-style-type: none"> • When the brake pedal is not depressed while shifting the gear.
 <p>ODEPV052147L</p>	<p>A: Shift to P after stopping</p> <ul style="list-style-type: none"> • When the gear is shifted to P (Park) while the vehicle is moving.
 <p>ODEPV052148L</p>	<p>A: This gear is already selected</p> <ul style="list-style-type: none"> • When the selected gear button is pressed again.
 <p>ODEPV052149L</p>	<p>A: PARK button error! Engage parking brake when parking vehicle</p> <ul style="list-style-type: none"> • When there is a problem with function engaging P (Park) position.

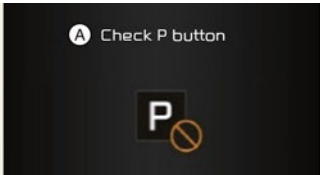
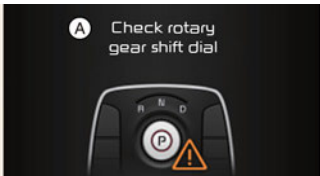
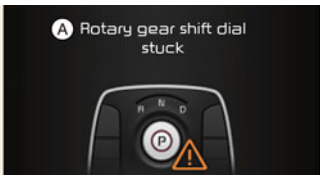
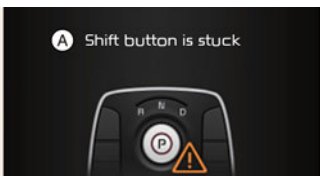
Message	Content
 <p>ODEPV052150L</p>	<p>A: Check P button</p> <ul style="list-style-type: none"> When there is problem with the P button.
 <p>ODEPV052151L</p>	<p>A: Check rotary gear shift dial</p> <ul style="list-style-type: none"> When there is problem with the shift dial.
 <p>ODEPV052152L</p>	<p>A: Rotary gear shift dial stuck</p> <ul style="list-style-type: none"> When the shifter dial is continuously stuck or there is problem with the shifter dial.
 <p>ODEPV052153L</p>	<p>A: Shift button is stuck</p> <ul style="list-style-type: none"> When the shift button is stuck.

Regenerative braking system

The regenerative braking system allows you to charge the battery when you use the brakes to stop the vehicle.

Adjusting regenerative braking with paddle shifter



Operation

- Pull the left side (⏪) of the paddle shifter to increase regenerative braking and deceleration.
- Pull the right side (⏩) of the paddle shifter to decrease regenerative braking and deceleration.

Non-operating condition(s)

- The left side (⏪) and right side (⏩) of paddle shifters are pulled simultaneously.
- Decelerating the vehicle by depressing the brake pedal.
- Cruise Control or Smart Cruise Control is operating.

- The regenerative braking system is activated in 100% charge.

Regenerative braking system according to DRIVE MODE

- Initial setting of the regenerative braking level and adjustable range vary according to the selected drive mode.
- For more details, refer to "Drive mode integrated control system" on page 6-31.

Drive mode	Initial setting
ECO+	2
ECO	2
NORMAL	1
SPORT	1

One pedal driving

The driver can stop the vehicle by pulling and holding the left side paddle shifter.

Operation

- Pull and hold the left side (⏪) of the paddle shifter while coasting.
- When the vehicle speed is above 3 km/h (2 mph), regenerative braking level will return to the previously set level when the paddle shifter is released.
- When the vehicle speed is below 3 km/h (2 mph), the vehicle stopping control will be maintained when the paddle shifter is released.
- While one pedal driving function is operating, the driver can control the vehicle stopping position by accelerator pedal.

Operating condition(s)

- The driver's door is closed.
- The driver's seat belt is fastened.
- EPB is automatically activated when:
 - The driver's door is opened.
 - Seat belt is not fastened
 - The hood is opened.
 - The tailgate is opened.
 - Vehicle stops for more than approximately 5 minutes
 - At the request of other systems.

Smart regeneration system

The Smart Regeneration System controls the regenerative braking automatically according to the road gradient and driving condition of the vehicle in front.

The system minimizes the unnecessary operation of the brake and acceleration pedal, improving the electric efficiency and assisting the driver.

Operating smart regeneration system

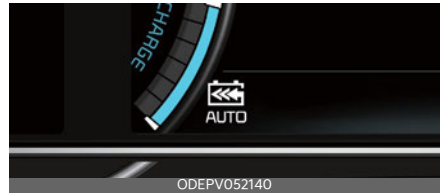

Operation

1. Select **Convenience** → **Smart Regeneration** from the Settings menu.
2. Pull and hold the right side (↵) of the paddle shifter for more than approximately 1 second.
 - **AUTO** symbol will be displayed on the cluster.
 - The regenerative braking level can be adjusted based on the driver's deceleration style.

Operating condition(s)

- When the vehicle speed is above approximately 10 km/h (6 mph)
- The road gradient changes
- Distance from the vehicle ahead reduces or increases
- Speed of the vehicle ahead reduces or increases

Detecting sensor

Front radar



Always make sure the radar sensor cover is clean and free of dirt, snow, and debris.

Dirt, snow, or foreign substances on the lens may adversely affect the sensing performance of the sensor. In this case, the system operation may stop temporarily and not operate normally.

Temporarily canceling smart regeneration system

Operating condition(s)

- The vehicle is shifted to N (Neutral), R (Reverse) or P (Park).
- Cruise Control or Smart Cruise Control is operating.
- ESC (Electronic Stability Control) or ABS is operating.

Setting default smart regeneration system level

Operation

- Pull the paddle shifter when the smart regeneration system is ON. The level adjustment by smart regeneration system will operate above set level.

Resuming smart regeneration system

Operation

- Pull and hold the right side of the paddle shifter for more than approximately 1 second again.

Turning smart regeneration system off

Operation

- Pull and hold the right side of the paddle shifter for more than approximately 1 second.

Smart regeneration system malfunction and limitations

Smart regeneration system malfunction



A: Check smart recuperation system

The message will appear when the system is not functioning normally. The system will be canceled and the word **AUTO** on the cluster will disappear and instead display regenerative braking level. Check for foreign substances on the front radar. Remove any dirt, snow, or foreign material that could interfere with the radar sensors. If the system still does not operate normally, have the vehicle inspected by a professional workshop. Kia recommends visiting an authorized Kia dealer/service partner.

Limitations of smart regeneration system

Driving on a curved road



When driving on the curve, the system may not detect the vehicle in your lane and the regenerative braking level will reduce automatically, making you feel that the vehicle is accelerating.

Also, if the system suddenly recognizes the vehicle in front, the regenerative braking level will increase automatically, making you feel that the vehicle is decelerating.

The driver must maintain a safe braking distance, and if necessary, depress the brake pedal to reduce your driving speed in order to maintain a safe distance.



The smart regeneration system may recognize a vehicle in an adjacent lane when driving on a curved road. In this case, the system increase the braking level and slow the vehicle.

Always pay attention to road and driving conditions while driving. If necessary, depress the brake pedal to reduce your driving speed in order to maintain a safe distance. Also, when necessary, you may

depress the accelerator pedal to prevent the system from unnecessarily decelerating your vehicle.

Always check the traffic conditions around the vehicle.

Driving on a sloped road



When driving on an uphill or downhill, the system may not detect the vehicle in your lane and the regenerative braking level will reduce automatically, making you feel that the vehicle is accelerating. Also, if the system suddenly recognizes the vehicle in front, the regenerative braking level will increase automatically, making you feel that the vehicle is decelerating.

The driver must maintain a safe braking distance, and if necessary, depress the brake pedal to reduce your driving speed in order to maintain a safe distance.

Changing lanes

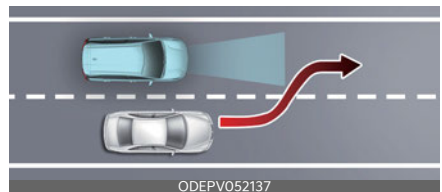

When a vehicle changes lanes in front of you, the smart regeneration system may not immediately detect the vehicle, especially if the vehicle changes lanes abruptly. In this case, you must maintain

a safe braking distance, and if necessary, depress the brake pedal to reduce your driving speed in order to maintain a safe distance.

Recognizing the vehicle

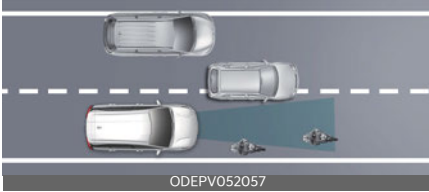

Some vehicles in your lane cannot be recognized by the sensor:

- Narrow vehicles such as motorcycles or bicycles
- Vehicles offset to one side
- Slow-moving vehicles or sudden-decelerating vehicles
- Stopped vehicles (When the vehicle ahead drives away, the system may not detect a stopped vehicle.)
- Vehicles with small rear profile such as trailers with no loads

A vehicle ahead cannot be recognized correctly by the sensor if any of following occurs:

- When the vehicle is pointing upwards due to overloading in the luggage compartment
- While the steering wheel is operating
- When driving to one side of the lane
- When driving on narrow lanes or on curves

Apply the brake or accelerator pedal if necessary.

⚠ WARNING

- When vehicle speed is under 10 km/h (6 mph), the Smart Regeneration System is canceled. The driver must adjust the vehicle speed by depressing the accelerator or brake pedal according to the road condition ahead and driving condition.
- Smart Regeneration System relies on front view camera in the vehicle. Foreign substances on the front view camera may cause the malfunction of Smart Recuperation System. Be sure to maintain clear view for the front view camera.
- The Smart Regeneration System will not operate when the Forward Safety warning light on the cluster appears. The driver must adjust the vehicle speed by depressing the accelerator or brake pedal according to the road condition ahead and driving condition.
- The Smart Regeneration System which automatically controls the regenerative braking level when coasting is only a supplemental system for the driver's convenience. Do not solely rely on this system to stop the vehicle. The system cannot completely stop the vehicle in all situations nor avoid all collisions. The brake control may be insufficient depending on the speed of the vehicle in front and when the vehicle in front suddenly stops, a vehicle cuts in suddenly and there is a steep slope. Always look ahead cautiously to prevent unexpected and sudden situations from occurring.
- When the Smart Regeneration System is canceled automatically, adjust the vehicle speed directly by depressing

the accelerator or brake pedal according to the road and driving conditions ahead.

- When using the Smart Regeneration System take the following precautions:
 - If an emergency stop is necessary, you must apply the brakes.
 - Keep a safe distance according to road conditions and vehicle speed. If the vehicle to vehicle distance is too close during a high-speed driving, a serious collision may result.
 - Always maintain sufficient braking distance and decelerate your vehicle by applying the brakes if necessary.
 - The Smart Regeneration System is designed to detect and monitor the vehicle ahead in the roadway through radar signals. It is not designed to detect oncoming vehicles, pedestrians, bicycles, motorcycles, or smaller wheeled objects such as luggage bags, shopping carts, or strollers.
 - Vehicles moving in front of you with a frequent lane change may cause a delay in the system's reaction or may cause the system to react to a vehicle actually in an adjacent lane. Always drive cautiously to prevent unexpected and sudden situations from occurring.
 - The Smart Regeneration System may not recognize complex driving situations so always pay attention to driving conditions and control your vehicle speed.

CAUTION

- Do not apply license plate frame or foreign objects such as a bumper sticker or a bumper guard near the radar sensor. Doing so may adversely affect the sensing performance of the radar.
- Always keep the radar sensor and lens cover clean and free of dirt and debris.
- Use only a soft cloth to wash the vehicle. Do not spray pressurized water directly on the sensor or sensor cover.
- Be careful not to apply unnecessary force on the radar sensor or sensor cover. If the sensor is forcibly moved out of proper alignment, the Smart Regeneration System may not operate correctly. In this case, a warning message may not be displayed. Have the vehicle inspected by a professional workshop. Kia recommends visiting an authorized Kia dealer/service partner.
- If the front bumper becomes damaged in the area around the radar sensor, the Smart Regeneration System may not operate properly. Have the vehicle inspected by a professional workshop. Kia recommends visiting an authorized Kia dealer/service partner.
- Use only Kia Genuine Parts or those of an equivalent standard to repair or replace a damaged sensor or sensor cover. Do not apply paint to the sensor cover.

* NOTICE

The Smart Regeneration System may not operate temporarily due to:

- Electrical interference
 - Modifying the suspension
 - Differences of tire abrasion or tire pressure
 - Installing different type of tires
-

Brake system

In the event of brake failure

Operation

- Make an emergency stop with the parking brake.

Operating condition(s)

- The brake has failed

Power-assisted brakes

Operation

- Apply greater force to the brake pedal.

Operating condition(s)

- The vehicle is stalled

Brake over accelerator

Operation

1. Apply the brakes steady and firmly.
2. Stop the vehicle safely.
3. Shift to P. Turn off the vehicle and apply the parking brake.
4. Inspect the accelerator pedal for any interference.

Operating condition(s)

- The accelerator pedal is stuck

Disc brakes wear indicator

The front or rear brakes will squeal when the brake pads are worn. Always replace the front or rear brake pads as pairs.

Brake disc cleaning

If there is a surface rust on the brake disc or squeal can be heard, operate

brake disc cleaning to clean the brake disc.

Electric energy economy may decrease while using brake disc cleaning because regenerative braking system is limited.

Operation

- Press and hold AUTO HOLD button more than 3 seconds.
 - Brake disc cleaning starts when an alarm appears on the instrument cluster.
 - Regenerative braking system is limited while braking about 10 times when you drive, eliminating squeal and rust on the brake.
 - Brake disc cleaning is turned off automatically when the operation is over. You can also turn off the system by pressing and holding the AUTO HOLD button more than 3 seconds.

⚠ WARNING

- Avoid applying the parking brake to stop the vehicle while it is moving except in an emergency situation. Applying the parking brake while the vehicle is moving at normal speeds can cause a sudden loss of control of the vehicle. If you must use the parking brake to stop the vehicle, use great caution in applying the brake.
- Avoid continuous application of the brakes when descending a long or steep hill. Continuous brake application will cause the brakes to overheat and could result in a temporary loss of braking performance.
- Do not ignore high pitched wear sounds from your brakes. If you ignore this audible warning, you will

eventually lose braking performance, which could lead to a serious accident.

⚠ CAUTION

- Do not drive with your foot resting on the brake pedal. This will create abnormally high brake temperatures which can cause excessive brake lining and pad wear.
- Do not continue to drive with worn brake pads. Continuing to drive with worn brake pads can damage the braking system and result in costly brake repairs.

* NOTICE

- Do not continue depressing the brake pedal if the  indicator is OFF. The battery may be discharged.
- Noise and vibration generated during braking is normal.
- Under normal operation, electric brake pump noise and motor vibration may occur temporarily in below cases.
 - When the pedal is depressed suddenly.
 - When the pedal is repeatedly depressed in short intervals.
 - When the ABS function is activated while braking.
- If none are found and the condition persists, have your vehicle towed to a professional workshop and inspected. Kia recommends visiting an authorized Kia dealer/service partner.
- Brake dust may accumulate on the wheels, even under normal driving conditions. Some dust is inevitable as the brakes wear and contribute to brake noise.

- The driving efficiency could decrease due to regenerative system deactivated.
- When stepping on the brake pedal under a certain driving or weather condition, you may witness your car make a sound of squealing or some other noises. This is not a brake malfunction but a normal phenomenon.
- When driving on the road to which deicing chemicals are applied, the vehicle may witness noises from the brake or abnormal abrasion of tires because of such deicing chemicals. You should operate brake additionally so that you would be able to remove the deicing chemicals on the brake disk and pad under a safe traffic condition.

Parking brake

Check if the brake warning light (ⓘ) appears when the vehicle is in the START or ON position. Be sure the parking brake is fully released and the brake warning light (ⓘ) is off before driving.

WARNING

- To reduce the risk of SERIOUS INJURY or DEATH, do not operate the parking brake while the vehicle is moving except in an emergency situation. It could damage the brake system and lead to an accident.
- Whenever leaving the vehicle or parking, always come to a complete stop and continue to depress the brake pedal. Make sure the gear is shifted to P (Park) position, then apply the parking brake, and set the START/STOP button to OFF position. Vehicles with the parking brake not fully engaged are at risk for moving inadvertently and causing injury to yourself or others.

- NEVER allow anyone who is unfamiliar with the vehicle to touch the parking brake. If the parking brake is released unintentionally, serious injury may occur.
- Only release the parking brake when you are seated inside the vehicle with your foot firmly on the brake pedal.
- Never allow a passenger to touch the parking brake. If the parking brake is released unintentionally, serious injury may occur.

NOTICE

- Do not apply the accelerator pedal while the parking brake is engaged. If you depress the accelerator pedal with the parking brake engaged, warning will sound. Damage to the parking brake may occur.
- Driving with the parking brake on can overheat the braking system and cause premature wear or damage to brake parts. Make sure the parking brake is released and the brake warning light is off before driving.

Electronic Parking Brake EPB

Applying the EPB manually



Operation

- Depress the brake pedal and pull the EPB switch up to apply the parking brake.

⚠ WARNING

- Risk of accident and injury due to children left unattended in the vehicle. If you leave children unaccompanied in the vehicle, they may be able to set the vehicle in motion, for example by:
 - Releasing the parking brake.
 - Shifting the gear out of P (Park) position.
 - Starting the vehicle. In addition, they may operate vehicle equipment.
- Never leave children and animals unattended in the vehicle.
- When leaving the vehicle, always take the smart key with you and lock the vehicle.

*** NOTICE**

- On a steep incline or when pulling a trailer, if the vehicle does not remain at a standstill, do as follows:
 - Apply the EPB.
 - Pull up the EPB switch for more than 3 seconds.

- A click or electric brake motor whine sound may be heard while operating or releasing the EPB. These conditions are normal and indicate that the EPB is functioning properly.

Applying the EPB automatically

Operating condition(s)

- Shifting to P
- Vehicle in OFF position with AUTO HOLD enabled
- When the vehicle moves a bit in P
- At the request of other systems.
- The conditions below apply when Auto Hold is enabled:
 - The driver's door is opened.
 - The hood is opened.
 - The tailgate is opened.
 - The vehicle stops for more than approximately 10 minutes on a steep slope
 - At the request of other systems.
- If equipped with Electronic Parking Brake, parking brake is applied automatically when the gear is shifted to P (Park).

⚠ CAUTION

- If you notice a continuous noise or burning smell when the EPB is used for emergency braking, have your vehicle checked by a professional workshop. Kia recommends to visit an authorized Kia dealer/service partner.
- If the gear is shifted to N (Neutral) while Electronic Parking Brake is applied, it is not released automatically. If you don't release Electronic Parking Brake manually before using an automatic car wash tunnel machine or etc., this may result in

damage to the vehicle or the automatic car wash tunnel machine.

* NOTICE

For Electronic Parking Brake **EPB** equipped vehicles with AUTO HOLD function used while driving, if the START/STOP button is in OFF position, the EPB will be engaged automatically. Therefore, AUTO HOLD function should be turned off before the START/STOP button is in OFF position.

Releasing EPB manually

Operation

- Depress the brake pedal. Make sure the gear is in P and push the EPB switch down to release the parking brake.

Releasing EPB automatically

Operation

1. Start the vehicle.
2. Fasten the driver's seat belt.
3. Close the driver's door, hood and tailgate.
4. When the vehicle is ON, depress the brake pedal and shift to R or D.
5. Depress the accelerator pedal while the gear is in R, D or manual mode.

⚠ CAUTION

Do not drive your vehicle with the EPB applied. It may cause excessive brake pad and brake rotor wear.

⚠ WARNING

- Never allow a passenger, children, or animal to touch the Electronic Parking Brake.
- Do not input any other objects around the Electronic Parking Brake. It may be operated unintentionally.

⚠ CAUTION

- Whenever leaving the vehicle or parking, make sure the gear is shifted to P (Park) position, then apply the parking brake. Block the tires if necessary.
- Electronic Parking Brake may not be released because it can freeze in winter. Do not use Electronic Parking Brake and shift the gear to P (Park), block the tires, and park the vehicle on the flat and safe road. If the Electronic Parking Brake is applied when you shift the gear to P (Park), release the Auto Hold and Electronic Parking Brake, and park the vehicle with the tires blocked.
- When driving with the Electronic Parking Brake applied, brake system may be overheated, brake lines may be worn, and the Electronic Parking Brake may be damaged.
- A click or electric brake motor whine sound may be heard while operating or releasing the Electronic Parking Brake.
- If you hand over the vehicle to other people, make sure they understand how to use the Electronic Parking Brake for safety.
- When the battery charge is not sufficient, Electronic Parking Brake may not be applied or released. In this case, connect to the auxiliary battery.

* NOTICE

- For the Middle East, EPB is released regardless of seat belt fastening.
- Do not follow these procedures when driving on a flat level ground. The vehicle may suddenly move forward:
 - For your safety, depress the brake pedal and release the parking brake manually with the EPB switch when you drive downhill or when Reversing the vehicle.
 - For your safety, you can engage the EPB even though the vehicle is in the OFF position, but you cannot release it.
- If the parking brake warning light is still on even though the EPB has been released, have the system checked by a professional workshop. Kia recommends visiting an authorized Kia dealer/service partner.

EPB warning message

Operating condition(s)

- Attempting to drive off using the accelerator pedal with the EPB applied
- Driver's seat belt is not fastened and the vehicle hood, driver's door or the tailgate is opened.
- There is a problem with the vehicle
- Conversion from AUTO HOLD to EPB is not working properly
- EPB is applied while AUTO HOLD is activated due to Electronic Stability Control (ESC) signal

EPB malfunction indicator



If the EPB malfunction indicator remains on, turns on while driving, or does not turn on when the vehicle is in the ON position, this indicates that the EPB may be malfunctioning.

Have your vehicle checked by a professional workshop as soon as possible. Kia recommends to visit an authorized Kia dealer/service partner.

* NOTICE

- The EPB warning light may appear if the EPB switch operates abnormally. Shut the vehicle off and turn it on again after a few minutes. The warning light will go off and the EPB switch will operate normally. However, if the EPB warning light is still on, have the system checked by a professional workshop. Kia recommends to visit an authorized Kia dealer/service partner.
- If the parking brake warning light does not appear or blinks even though the EPB switch was pulled up, the EPB is not applied.
- If the parking brake warning light blinks when the EPB warning light is on, press the EPB switch, then pull it up. Once more press it back to its original position and pull it back up. If the EPB warning does not go off, have the system checked by a professional workshop. Kia recommends to visit an authorized Kia dealer/service partner.

Emergency braking with the EPB switch

Operation

- Pull and hold the EPB switch up to engage the emergency brake.

⚠ WARNING

Do not operate the Electronic Parking Brake **EPB** while the vehicle is moving except in an emergency situation. Applying the EPB while the vehicle is moving at normal speeds can cause a sudden loss of control of the vehicle. If you must use the EPB to stop the vehicle, use great caution in applying the brake.

* NOTICE

During emergency braking by the EPB, the parking brake warning light will appear to indicate that the system is operating.

When the EPB does not release properly

Operation

1. Load the vehicle on a flatbed tow truck.
2. Take your vehicle to a professional workshop to check the system. Kia recommends visiting an authorized Kia dealer/service partner.

⚠ WARNING

Do not operate the Electronic Parking Brake **EPB** while the vehicle is moving except in an emergency situation. Applying the EPB while the vehicle is moving at normal speeds can cause a sudden loss of control of the vehicle. If you must

use the EPB to stop the vehicle, use great caution in applying the brake.

* NOTICE

During emergency braking by the EPB, the parking brake warning light will appear to indicate that the system is operating.

AUTO HOLD

The AUTO HOLD maintains the vehicle in a stopped position without depressing the brake pedal.

Applying AUTO HOLD

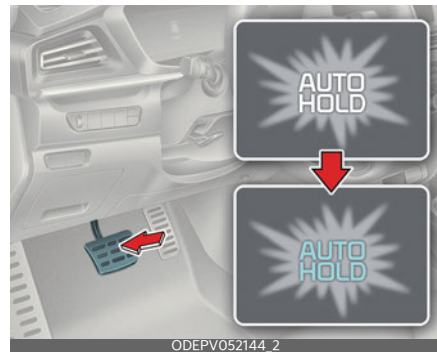

Operation

1. Press the AUTO HOLD button. The AUTO HOLD indicator will light up in white.
2. The AUTO HOLD indicator changes from white to green when the vehicle is stopped.
3. AUTO HOLD will be released automatically when the accelerator pedal is pressed in D, R, or manual mode. The AUTO HOLD indicator will change from green to white.

- Press the AUTO HOLD button again while pressing the brake pedal to cancel the AUTO HOLD operation.



Operating condition(s)

- Brake pedal is depressed after the vehicle has started.

Non-operating condition(s)

- P (Park) gear position is selected.
- The EPB is applied.

AUTO HOLD warning messages

Operating condition(s)

- When the EPB is automatically applied from AUTO HOLD
- AUTO HOLD to EPB conversion is not working properly
- Brake pedal is not applied when the AUTO HOLD button is pressed

* INFORMATION

If the vehicle is restarted with the AUTO HOLD button pressed, AUTO HOLD will be in the standby state.

⚠ WARNING

To reduce the risk of an accident, do not activate AUTO HOLD while driving downhill, reversing or parking your vehicle.

* NOTICE

- If the AUTO HOLD indicator lights up yellow, the AUTO HOLD is not working properly. Take your vehicle to a professional workshop and have the system checked. Kia recommends visiting an authorized Kia dealer/service partner.
- A click or electric brake motor whine sound may be heard while operating or releasing the EPB, but these conditions are normal and indicate that the EPB is functioning properly.
- If the vehicle is restarted with the Auto Hold system is in the standby position or operating, the Auto hold system will continue to operate in the standby position.

Vehicle safety system

Anti-lock Brake System (ABS)

The Anti-lock Brake System (ABS) prevents the wheels from locking up in order to steer and stabilize the vehicle. If the ABS warning light (🚗) stays on, contact a professional workshop as soon as possible. Kia recommends visiting an authorized Kia dealer/service partner.

* NOTICE

- A click sound may be heard in the vehicle compartment when the vehicle begins to move after the vehicle is started. These conditions are normal and indicate that the Anti-lock Brake System is functioning properly.
- When you jump start your vehicle because of a drained battery, the vehicle may not run as smoothly and the ABS warning light may turn on at the same time. This happens because of low battery voltage. It does not mean your ABS has malfunctioned.
 - Do not pump your brakes!
 - Have the battery recharged before driving the vehicle.

Electronic Stability Control (ESC)

Electronic Stability Control (ESC) is designed to stabilize the vehicle during cornering maneuvers.

ESC is not a substitute for safe driving practices. Factors such as speed, road conditions, and driver steering input can all affect whether ESC will be effective in preventing loss of control.

Operating ESC

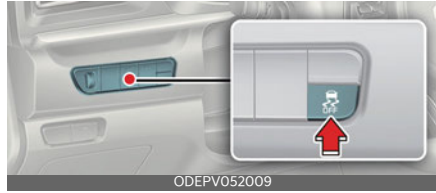

Operation

- Press the ESC OFF button for approximately half a second to turn ESC off. ESC OFF (🚗) indicator light will appear and the warning chime will sound.
- Press and hold the ESC OFF button again for approximately 3 seconds to turn ESC and traction control off. ESC OFF (🚗) indicator light will appear and the warning chime will sound.
- To turn ESC on again, press the ESC OFF button. ESC OFF (🚗) indicator light will go off.

⚠ WARNING

- For maximum protection, always wear your seat belt. No system, no matter how advanced, can rectify for all driver error and/or driving conditions. Always drive responsibly.
- Drive carefully even though your vehicle has Electronic Stability Control. It can only assist you in maintaining control under certain circumstances.
- When ESC (electric vehicle control) is deactivated, the vehicle will lose the traction and stability if the vehicle is driven by abrupt steering wheel control. It is possible that the tire may make a collision with the connected parts of the tire. We recommend to do not turn off ESC while driving the vehicle for your safety.

* NOTICE

- A click sound may be heard in the vehicle compartment when the vehicle begins to move after the vehicle is started. These conditions are normal and indicate that the Electronic Stability Control system is functioning properly.
- When operating the vehicle on a dynamometer, ensure that the ESC is turned off (ESC OFF light appears). If the ESC is left on, it may prevent the vehicle speed from increasing, and result in false diagnosis.
- Turning the ESC off does not affect ABS or brake system operation.
- Select 0 step of the regenerative braking system and depress the brake pedal around 10 times to efficiently apply brake disc cleaning. Brake disc cleaning may decrease.
- Brake disc cleaning may decrease the driving distance by restraining the regenerative braking system. After brake disc cleaning, the regenerative braking system may be restored.
- If the regenerative braking system is not restored after the brake disc cleaning, Kia recommends visiting an authorized Kia dealer/service partner.

Hill-start Assist Control (HAC)

Hill-start Assist Control (HAC) prevents the vehicle from rolling back by applying the brakes automatically for approximately 2 seconds (maximum of 5 seconds when the accelerator pedal is slightly depressed during HAC operation).

The brakes are released when the accelerator pedal is engaged or after approximately 2 seconds.

⚠ WARNING

HAC does not replace the need to apply brakes while stopped on an incline. While stopped, make sure you maintain brake pressure sufficient to prevent your vehicle from rolling backward and causing an accident. Don't release the brake pedal until you are ready to accelerate forward.

Vehicle Stability Management (VSM)

Vehicle Stability Management (VSM) provides further enhancements to vehicle stability and steering response.

Operating VSM



Operation

- Press the ESC OFF button to turn VSM off and the ESC OFF indicator light (🚗) appears.
- Press the ESC OFF button again to turn VSM on and the ESC OFF indicator light (🚗) will go off.

Operating condition(s)

- Driving on slippery roads
- Grip change of left and right wheels is detected

Non-operating condition(s)

- Driving on a gradient or inclined surface
- Driving in reverse.
- ESC OFF indicator light (🚫) remains appear
- EPS warning light (⚠️) remains appear

VSM malfunction indicator

VSM can be deactivated when a malfunction has been detected in the Electric Power Steering system or VSM system. If the ESC indicator light (🚫) or EPS warning light (⚠️) remains on, take your vehicle to a professional workshop and have the system checked. Kia recommends visiting an authorized Kia dealer/service partner.

⚠️ WARNING

When replacing tires and wheels, make sure they are the same size as the original tires and wheels installed. Driving with varying tire or wheel sizes may diminish any supplemental safety benefits of the VSM system.

Emergency Stop Signal (ESS) (if equipped)

The Emergency Stop Signal (ESS) alerts the driver behind by flashing the brake lights when braking sharply and severely.

Operating condition(s)

- The vehicle suddenly stops.
- ABS is activated and the driving speed is over 55 km/h (34 mph).
- The hazard warning flasher automatically turns ON after blinking the brake lights when:

- The driving speed is under 40 km/h (25 mph)
- The ABS is deactivated
- The sudden braking is over
- The hazard warning flasher turns OFF when:
 - The vehicle drives at a low speed for a certain period of time.

*** NOTICE**

The Emergency Stop Signal (ESS) system will not activate, when the hazard warning flashers are already on.

Brake Assist System (BAS)

The Brake Assistant System provides additional pressure when the brake pedal is momentarily and strongly depressed in a situation sudden braking is required while driving.

The Brake Assistant System reduces the time for ABS(Anti-Lock Brake System) control to enter and consequently reduces the braking distance, by providing additional pressure up to the point of ABS intervention.

BAS operation

- When the vehicle speed is more than 30 km/h (20 mph) and the ABS control is not entered.
- When the brake pedal is depressed strongly over a certain level.
- When the friction of the road surface is above a certain level.

BAS operation off

- The vehicle speed is below 10 km/h (6 mph).
- When the brake pedal is depressed strongly over a certain level.
- The friction of the road surface is below a certain level.

⚠ WARNING

The system may not operate depending on driver's driving habit, the degree to which the brake pedal is depressed and the road surface condition.

Drive mode integrated control system

DRIVE MODE

Selecting DRIVE MODE



Operation

- Press the **DRIVE MODE** button.
- Press and hold **DRIVE MODE** button to change to **ECO+** mode.
- **DRIVE MODE** will change to **NORMAL** mode when the vehicle is restarted. **ECO** mode will be maintained when the vehicle is restarted.

DRIVE MODE characteristics

*1: Change to ECO+ mode

*2: It is possible to set the driving condition for each drive mode (except the ECO+ mode) at the drive mode setting in the infotainment system. For more information, refer to the separately supplied manual.

DRIVE MODE	NORMAL	SPORT	ECO	ECO+ ^{*1}
Characteristics	Normal driving mode	Sporty driving mode	Optimal for eco driving	Ultra power saving driving mode
Button activation	Press	Press	Press	Press and hold
Cluster indicator	-	SPORT	ECO	ECO+
Climate control system	NORMAL (ECO/NORMAL) ^{*2}	NORMAL (ECO/NORMAL) ^{*2}	ECO (ECO/NORMAL) ^{*2}	Off
Speed limit	-	-	- (90~130 km/h) ^{*2}	90 km/h
Regenerative braking level	1 (1~3) ^{*2}	1 (1~3) ^{*2}	2 (1~3) ^{*2}	2

* NOTICE

- Distance to empty may not change when the air conditioner/heater system is off. However, actual distance may be extended.
- Air conditioner/heater system turns off (except the defroster) but you may turn it on if necessary.
- When the drive mode is switched from the ECO+ mode to a different mode, it is changed to air conditioner/heater operation status of the ECO mode.
- The speed limit is automatically deactivated when Smart Cruise Control is in activation or the accelerator pedal is depressed to the end. If speed limit function is deactivated by depressing the accelerator pedal, the speed limit function will reactivate when vehicle speed is lower than the set speed limit. Also, the speed is changed to the speed set at ECO mode when the drive mode switches from the ECO+ mode to ECO mode.

Active air flap



ODEPV052011

Active air flap system controls the air flap below the front bumper to cool the vehicle parts and improve energy efficiency.

Active air flap malfunction

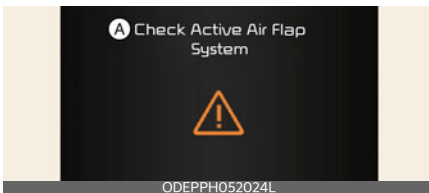

ODEPPH052024L

A: Check Active Air Flap system

The active air flap system may not operate normally if the air flap is temporarily opened due to foreign factors or if the controller is contaminated by snow or rain, etc.

When the message is popped up on the display, stop the vehicle in a safe place and check the status of the air flap.

Start the vehicle after performing the necessary work like foreign matter removal and waiting 10 minutes. If the pop-up remains up, have the vehicle inspected by a professional workshop. Kia recommends visiting an authorized Kia dealer/service partner.

⚠ CAUTION

- Regardless of the pop-up, if the air flaps aren't in the same position, stop the vehicle and wait for 10 minutes and start the vehicle and inspect the air flap.
- The active air flap system is actuated by motors. Do not disturb actuation or apply force excessively. It may cause failure.

* NOTICE

Active air flap system could be activated regardless of the vehicle condition.(Parking, driving, charging, etc.)

Forward Collision-Avoidance Assist (FCA) (Sensor Fusion) (if equipped)

Forward Collision-Avoidance Assist is to reduce or to avoid accident risk. It recognizes the distance from the vehicle ahead, the pedestrian or the cyclist through the sensors (i.e. front view camera and front radar), and, if necessary, warns the driver of accident risk with the warning message or the warning alarms and apply emergency braking.

* Sensor fusion (front view camera + front radar) Forward Collision-Avoidance Assist operates for the vehicle ahead, the pedestrian or the cyclist in front.

WARNING

Take the following precautions when using Forward Collision Avoidance Assist:

- This function is only a supplemental function and it is not intended to, nor does it replace the need for the extreme care and attention of the driver. The sensing range and objects detectable by the sensors are limited. Pay attention to the road conditions at all times.
- Never drive too fast in accordance with the road conditions or while cornering.
- Always drive cautiously to prevent unexpected and sudden situations from occurring. Forward Collision-Avoidance Assist does not stop the vehicle completely and is only intended to help mitigate an imminent collision.

Forward Collision-Avoidance Assist setting

The driver can activate Forward Collision-Avoidance Assist by placing the vehicle to the ON position and by selecting:

User settings → **Driver assistance** → **Forward Collision-Avoidance Assist**

- Forward Collision-Avoidance Assist deactivates, when the driver cancels the function setting.

The warning light () appears on the LCD display, when you cancel Forward Collision-Avoidance Assist. The driver can monitor the Forward Collision-Avoidance Assist ON/OFF status on the LCD display. Also, the warning light appears when the ESC (Electronic Stability Control) is turned off. When the warning light remains ON with Forward Collision-Avoidance Assist activated, have the function checked by a professional workshop. Kia recommends to visit an authorized Kia dealer/service partner.

Warning Timing

The driver can select the initial warning activation time on the LCD display.

Go to the **User settings** → **Driver assistance** → **Forward collision warning** → **Fast/Normal/Slow**

The options for the initial Forward Collision Warning includes the following:

- **Fast:**
When this condition is selected, the initial Forward Collision Warning is activated earlier than Normal. This setting maximizes the amount of distance between the vehicle ahead, the pedestrian or the cyclist before the initial warning occurs.

- **Normal:**

When this condition is selected, the initial Forward Collision Warning is activated normally. This setting allows for a nominal amount of distance between the vehicle ahead before the initial warning occurs.

- **Slow:**

When this condition is selected, the initial Forward Collision Warning is activated later than normal. This setting reduces the amount of distance between the vehicle ahead, the pedestrian or the cyclist before the initial warning occurs.

Select Slow when traffic is light and when driving speed is slow.

If the vehicle in front puts on a burst of speed, the driver can notice the warning alarm is early even though the later option is selected.

Forward Collision-Avoidance Assist operating conditions

Forward Collision-Avoidance Assist gets ready to be activated, when **Forward Collision-Avoidance Assist** is selected on the LCD display, and when the following prerequisites are satisfied.

- The ESC is On.
- The driving speed is over 10 km/h (6 mph). (However, Forward Collision-Avoidance Assist is activated within certain driving speed.)
- When recognizing the vehicle or the pedestrian or the cyclist in front. (However, Forward Collision-Avoidance Assist does not activate according to conditions in front and vehicle functions, but it notices only certain warnings.)

- Forward Collision-Avoidance Assist does not operate properly or it only produces a warning alarms in accordance with the driving or vehicle condition.
- If the warning only under the Forward Safety system is selected, Forward Collision-Avoidance Assist produces only warning alarms in accordance with the collision risk levels.

* NOTICE

Forward Collision-Avoidance Assist may not operate properly according to the frontal situation, the direction of pedestrian or cyclist and speed.

⚠ WARNING

- Completely stop the vehicle in a safe location before operating the switch on the steering wheel to activate/deactivate Forward Collision-Avoidance Assist.
- Forward Collision-Avoidance Assist automatically activates upon placing the vehicle to the ON position. The driver can deactivate Forward Collision-Avoidance Assist by canceling the function setting on the LCD display.
- Forward Collision-Avoidance Assist automatically deactivates upon canceling the ESC. When the ESC is canceled, Forward Collision-Avoidance Assist cannot be activated on the LCD display.
Forward Collision-Avoidance Assist warning light will appear, which is normal.

Forward Collision-Avoidance Assist warning and control

Forward Collision-Avoidance Assist produces warning messages and warning alarms in accordance with the collision risk levels of followings like vehicle's sudden braking in front or lack of vehicle to vehicle distance or collision to pedestrians or cyclist. Also, it controls the brakes in accordance with the collision risk levels.

The driver can select the initial warning activation time in the User Settings in the LCD display. The options for the initial Forward Collision Warning include Fast, Normal or Slow initial warning time.

Collision Warning

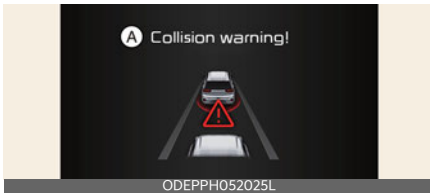

A: Collision warning!

- The warning message appears on the LCD display with the warning alarms.
- The Vehicle may slow down slightly
 - It will operate if the vehicle speed is greater than 10 km/h (6 mph) and less than or equal to 180 km/h (112 mph) on a forward vehicle. (Depending on the condition of the vehicle ahead and the environment surrounding it, the possible maximum operating speed may be reduced.)
 - For pedestrian and cyclist, the vehicle speed is greater than or equal to 10 km/h (6 mph) and less than 85 km/h (53 mph). (Depending on the condition of pedestrian and cyclist

and the surrounding environment the possible maximum operating speed may be reduced.)

- Forward Collision-Avoidance Assist controls the brakes within certain limit to release shock from the collision.

Emergency braking

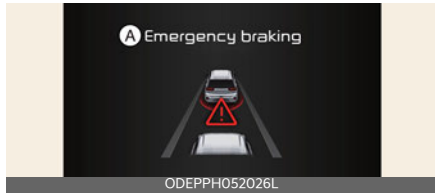

A: Emergency braking

- The warning message appears on the LCD display with the warning alarms.
- The brake control is maximized just before a collision, reducing impact when it strikes a forward vehicle.
 - It will operate if the vehicle speed is greater than 10 km/h (6 mph) and less than or equal to 85 km/h (53 mph) on a forward vehicle. (Depending on the condition of the vehicle ahead and the environment surrounding it, the possible maximum operating speed may be reduced.)
 - For pedestrian and cyclist, the vehicle speed is greater than or equal to 10 km/h (6 mph) and less than 65 km/h (40 mph). (Depending on the condition of pedestrian and bike riders and the surrounding environment the possible maximum operating speed may be reduced.)
- Forward Collision-Avoidance Assist controls the brakes within certain limit to release shock from the collision.

Forward Collision-Avoidance Assist controls the maximum brakes just before the collision.

* NOTICE

- In an urgent situation, the braking system enters into the ready status for prompt reaction to assist the driver in depressing the brake pedal.
- Forward Collision-Avoidance Assist provides additional braking power for optimum braking performance, when the driver depresses the brake pedal.
- The braking control is automatically deactivated, when the driver sharply depresses the accelerator pedal, or when the driver abruptly operates the steering wheel.
- The braking control is automatically canceled, when risk factors disappear.

⚠ CAUTION

The driver should always pay great caution to vehicle operation, even though there is no warning message or warning alarm.

⚠ WARNING

Forward Collision-Avoidance Assist cannot avoid all collisions. Forward Collision-Avoidance Assist might not completely stop the vehicle before collision, due to ambient, weather and road conditions. The driver has the responsibility to drive safely and control the vehicle.

⚠ WARNING

Forward Collision-Avoidance Assist operates in accordance with the risk levels, such as the distance from the vehicle/passenger in front, the speed of the vehicle/passenger in front, and the driver's vehicle operation.

For the function to activate, do not attempt risky driving.

* NOTICE

When a collision is imminent, the Forward Collision-Avoidance Assist may assist the driver with brakes if the driver fails to brake enough.

Detecting sensors

Front view camera



ODEPV052013

Front radar



ODEPV052022

The sensors are detecting the distance to vehicle ahead, pedestrian or cyclist.

In bad weather conditions such as heavy rain, heavy snow, and fog, or when sensor is covered by foreign material, dust, etc., the sensors will be degraded and the function will be temporarily disabled. Always keep the sensor clean.

* NOTICE

- Do not install any accessories, such as license plate molding or sticker, on the sensor area. Nor arbitrarily replace the bumper. Those may adversely affect the sensing performance.
- Always keep the sensor/bumper area clean.
- Use only soft clothes to wash the vehicle. Also, do not spray highly pressurized water on the sensor installed on the bumper.
- Be careful not to apply unnecessary force on the frontal sensor area. When the sensor moves out of the correct position due to external force, the function may not normally operate even without the warning light or message. In this case, have the vehicle inspected by a professional workshop. Kia recommends to visit an authorized Kia dealer/service partner.
- The genuine Kia front radar sensor covers are parts with quality and performance ensured. If arbitrarily applying paint on or changing the cover, Forward Collision-Avoidance Assist may not function properly.
Use only Kia Genuine Parts or those of an equivalent standard with proven quality and performance to repair or replace the radar sensor covers.
- Do not tint the window or install stickers, accessories around the inside mirror where the camera is installed.
- Make sure the frontal camera installation point does not get wet.
- Do not impact or arbitrarily remove any radar/camera components.
- Do not place reflective objects (white paper or mirror etc.) on the crash pad.

The function may activate unnecessarily due to reflect of the sunlight.

- Excessive audio volume may disturb the sound of the function warning alarm.
- For more cautions for the camera sensor, refer to "Lane Keeping Assist (LKA) (if equipped)" on page 6-45.

Forward Collision-Avoidance Assist disabled

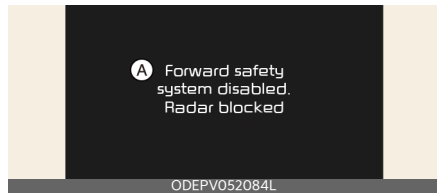

A: Forward safety system disabled. Radar blocked

When the sensor cover is blocked with dirt, snow, or debris, Forward Collision-Avoidance Assist operation may temporarily stop. In this case, the warning message appears to warn the driver.

This is not a malfunction with Forward Collision-Avoidance Assist. To operate Forward Collision-Avoidance Assist again, remove the foreign substances. Forward Collision-Avoidance Assist may not properly operate in an area (e.g. open terrain), where any substances are not detected after turning ON the vehicle.

⚠ WARNING

Forward Collision-Avoidance Assist may be inactive without any warning messages according to driving condition, traffic on the road, weather, road condition, etc.

Forward Collision-Avoidance Assist malfunction

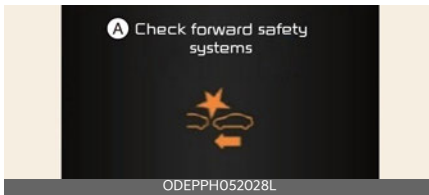

A: Check forward safety systems

- When Forward Collision-Avoidance Assist is not working properly, the Forward Collision-Avoidance Assist warning light (🚗) will appear and the warning message will appear for a few seconds. After the message disappears, the master warning light (⚠️) will appear. In this case, have the vehicle inspected by a professional workshop. Kia recommends to visit an authorized Kia dealer/service partner.
- The Forward Collision-Avoidance Assist warning message may appear along with the illumination of the ESC warning light.

⚠️ WARNING

- Forward Collision-Avoidance Assist is only a supplemental function for the driver's convenience. The driver should hold the responsibility to control the vehicle operation. Do not solely depend on Forward Collision-Avoidance Assist. Rather, maintain a safe braking distance, and, if necessary, depress the brake pedal to lower the driving speed.
- In certain instances and under certain driving conditions, Forward Collision-Avoidance Assist may activate unintentionally. This initial warning mes-

sage appears on the LCD display with a warning chime.

Also, in certain instances the front radar sensor or camera recognition function may not detect the vehicle, pedestrian or cyclist ahead. Forward Collision-Avoidance Assist may not activate and the warning message will not be displayed.

- Forward Collision-Avoidance Assist may unnecessarily produce the warning message and the warning alarms. Also, due to the sensing limitation, Forward Collision-Avoidance Assist may not produce the warning message and the warning alarm at all.
- When there is a malfunction with Forward Collision-Avoidance Assist, the braking control does not operate upon detecting a collision risk even with other braking systems normally operating.
- Forward Collision-Avoidance Assist operates only for the vehicle/pedestrian in front, while driving forward. It does not operate for any animals or vehicles in the opposite direction.
- Forward Collision-Avoidance Assist does not recognize the vehicle, which horizontally drives across the crossroad, or the vehicle, which is parked in the horizontal direction.
- If the vehicle in front stops suddenly, you may have less control of the brake system. Therefore, always keep safe distance between your vehicle and the vehicle in front of you.
- Forward Collision-Avoidance Assist may activate during braking and the vehicle may stop suddenly. And the load in the vehicle may endanger passengers. Therefore, always be mindful of the load volume in the vehicle.

- Forward Collision-Avoidance Assist may not activate if the driver applies the brake pedal to avoid risk of collision.
- Forward Collision-Avoidance Assist does not operate when the vehicle is in reverse. In these cases, you must maintain a safe braking distance, and if necessary, depress the brake pedal to reduce the driving speed in order to maintain a safe distance.
- The regular braking function will operate normally even if there is a problem with Forward Collision-Avoidance Assist brake control system or other functions. In this case, the braking control will not operate in the risk of a collision.
- Forward Collision-Avoidance Assist may not activate according to driving condition, traffic on the road, weather, road condition, etc.
- Forward Collision-Avoidance Assist may not activate to all types of vehicles.

Limitation of Forward Collision-Avoidance Assist

Forward Collision-Avoidance Assist is an assistant function for a driver in a certain risky driving condition and it does not take every responsibility for all risks from driving condition.

Forward Collision-Avoidance Assist recognizes the driving situations through front view camera and front radar. Thus, for a situation out of the sensing range, Forward Collision-Avoidance Assist may not normally operate. The driver should pay great caution in the following situations. Forward Collision-Avoidance Assist operation may be limited.

Recognizing vehicles

The sensor may be limited when:

- The front view camera or front radar sensor is blocked with a foreign object or debris
- The camera lens is contaminated due to tinted, filmed or coated windshield, damaged glass, or stuck of foreign matter (sticker, bug, etc.) on the glass
- Inclement weather such as heavy rain or snow obscures the field of view of the radar sensor or camera
- There is interference by electromagnetic waves
- There is severe irregular reflection from the radar sensor
- The front view camera/front radar sensor recognition is limited
- The vehicle in front is too small to be detected (for example a motorcycle etc.)
- The vehicle in front is an oversize vehicle or trailer that is too big to be detected by the camera recognition function (for example a tractor trailer, etc.)
- The front view camera's field of view is not well illuminated (either too dark or too much reflection or too much backlight that obscures the field of view)
- The vehicle in front does not have their rear lights or their rear lights does not turned ON or their rear lights are located unusually.
- The outside brightness changes suddenly, for example when entering or exiting a tunnel
- When light coming from a street light or an oncoming vehicle is reflected on a wet road surface such as a puddle in the road

- The field of view in front is obstructed by sun glare
- The vehicle in front is driving erratically
- The vehicle is on unpaved or uneven rough surfaces, or road with sudden gradient changes.
- The vehicle is driven near areas containing metal substances as a construction zone, railroad, etc.
- The vehicle drives inside a building, such as a basement parking lot
- The front view camera does not recognize the entire vehicle in front.
- The front view camera is damaged.
- The brightness outside is too low such as when the headlamps are not on at night or the vehicle is going through a tunnel.
- There is a shadow on the road by a median strip, trees, etc.
- The vehicle drives through a tollgate.
- The windshield glass is fogged up; a clear view of the road is obstructed.
- The rear part of the vehicle in front is not normally visible. (the vehicle turns in other direction or the vehicle is overturned.)
- The adverse road conditions cause excessive vehicle vibrations while driving
- The sensor recognition changes suddenly when passing over a speed bump
- The vehicle in front is moving longitudinally to the driving direction
- The vehicle in front is stopped longitudinally
- The vehicle in front is driving towards your vehicle or reversing
- You are on a roundabout and the vehicle in front circles
- It is difficult to secure the field of view of the front view camera such as backlight, reflected light, and darkness.
- When the front camera is blocked by continuous washer spray and wiper operation.
- The vehicle in front is a special purpose vehicle, a trailer, or a truck loading with unusual shape of luggage.
- The ambient light is too high or low.
- The front view camera is contaminated by front glass tinting, attaching film, water proof coating, foreign material such as a sticker, insects, etc.
- When the front view camera (including lens) or front radar is damaged.
- If not using headlamp or using low beam in the night or in a tunnel.
- Backlight is shining in the driving direction of the vehicle. (Including oncoming vehicle headlights.)
- When the rear part of the vehicle in front is small or low.
- When a trailer or other vehicle is towing the vehicle in front.
- When the ground clearance of the vehicle in front is high.
- When a vehicle in front makes sudden lane changes unexpectedly.

- Driving on a curved road



The performance of Forward Collision-Avoidance Assist may be limited when driving on a curved road.

The front view camera or front radar sensor recognition function may not detect the vehicle, pedestrian or cyclist traveling in front on a curved road.

This may result in no alarm and braking when necessary.

Always pay attention to road and driving conditions, and if necessary, depress the brake pedal to reduce your driving speed in order to maintain a safe distance.



Forward Collision-Avoidance Assist may recognize a vehicle or pedestrian or cyclist in the next lane or outside the lane when driving on a curved road.

If this occurs, the function may unnecessarily alarm the driver and apply the brake. Always pay attention to road and driving conditions, while driving.

- Driving on an inclined road



The performance of Forward Collision-Avoidance Assist may be decreased while driving upward or downward on a slope. The front view camera or front radar sensor recognition may not detect the vehicle, pedestrian or cyclist in front.

This may result in unnecessary alarm and braking or no alarm and braking when necessary.

When the function suddenly recognizes the vehicle, pedestrian or cyclist in front while passing over a slope, you may experience sharp deceleration.

Always keep your eyes forward while driving upward or downward on a slope, and, if necessary, depress the brake pedal to reduce your driving speed in order to maintain distance.

- Changing lanes

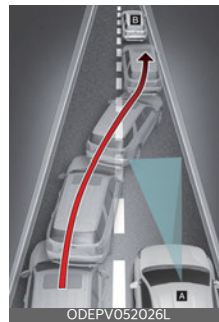

[A]: Your vehicle, [B]: Lane changing vehicle

Even though the vehicle in the next lane enters into your lane, it may not be recognized by Forward Collision-Avoidance Assist, until it enters Forward Collision-Avoidance Assist sensing range.

Especially when the vehicle in the next lane abruptly enters into your lane, it is more likely not to be recognized. Always pay great attention.

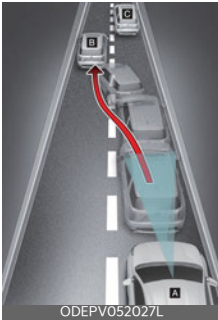

[A]: Your vehicle, [B]: Lane changing vehicle, [C]: Same lane vehicle

When driving in stop-and-go traffic, and a stopped vehicle in front of you merges out of the lane, Forward Collision-Avoidance Assist may not immediately detect the new vehicle that is now in front of you. In this case, you must maintain a safe braking distance, and if necessary, depress the brake pedal to reduce your driving speed in order to maintain a safe distance.

- Recognizing the vehicle

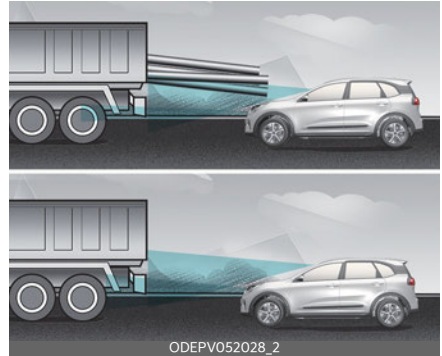

When the vehicle in front has heavy loading extended rearward, or when the vehicle in front has higher ground clearance, it may induce a hazardous situation. Always pay attention to road and driving conditions, while driving and, if necessary, depress the brake pedal to reduce your driving speed in order to maintain distance.

Detecting pedestrian or cyclist

The sensor may be limited when:

- The pedestrian or cyclist is not fully detected by the camera recognition function, for example, if the pedestrian is leaning over or is not fully walking upright
- The pedestrian or cyclist is moving very quickly or appears abruptly in the front view camera detection area
- The pedestrian or cyclist is wearing clothing that easily blends into the background, making it difficult to be detected by the front view camera recognition function
- The outside lighting is too bright (e.g. when driving in bright sunlight or in sun glare) or too dark (e.g. when driving on a dark rural road at night)

- It is difficult to detect and distinguish the pedestrian or cyclist from other objects in the surroundings, for example, when there is a group of pedestrians, cyclists or a large crowd
- There is an item similar in shape or appearance to a person
- The pedestrian or cyclist is below the sensor's viewing range
- The sensor can not identify the pedestrian's outline because of other items changing their profile, such as mobility assistance devices
- The front view camera or front radar is obstructed by a foreign object or debris
- Inclement weather such as heavy rain or snow obscures the field of view of the radar sensor or camera
- When light coming from a street light or an oncoming vehicle is reflected on a wet road surface such as a puddle in the road
- The field of view in front is obstructed by sun glare
- The windshield glass is fogged up; a clear view of the road is obstructed
- The adverse road conditions cause excessive vehicle vibrations while driving
- When the pedestrian or cyclist suddenly enters the path of travel of the vehicle
- When the cyclist in front is riding perpendicular to the direction of travel
- When there is any electromagnetic interference
- When the cyclist is near areas containing metal objects such as a construction zone, railroad, etc.
- If the bicycle material is not reflected well on the radar
- When a pedestrian or cyclist's height is small.
- When a pedestrian or cyclist's behavior is unstable.
- When a pedestrian or cyclist suddenly interrupts in front of the vehicle.
- When there are many pedestrians or cyclists.
- When there is an object that reflects radar well. (such as a guardrail or a nearby vehicle)

WARNING

- Do not use Forward Collision Avoidance Assist when towing a vehicle. Application of Forward Collision-Avoidance Assist while towing may adversely affect the safety of your vehicle or the towing vehicle.
- Use extreme caution when the vehicle in front of you has cargo that extends rearward from the cab, or when the vehicle in front of you has higher ground clearance.
- Forward Collision-Avoidance Assist is designed to detect and monitor the vehicle ahead or detect a pedestrian or cyclist in the roadway through front view camera recognition and front radar signals. It may not always detect bicycles, motorcycles, or smaller wheeled objects such as luggage bags, shopping carts, or strollers.
- Never try to test the operation of Forward Collision-Avoidance Assist. Doing so may cause severe injury or death.
- If the front bumper, front glass, front view camera or front radar have been replaced or repaired, have the vehicle inspected by a professional workshop. Kia recommends to visit an authorized Kia dealer/service partner.

- If the function detects an object that has a similar shape or characteristics of a vehicle or a pedestrian, Forward Collision-Avoidance Assist may operate.

* NOTICE

In some instances, Forward Collision-Avoidance Assist may be canceled when subjected to electromagnetic interference.

Lane Keeping Assist (LKA) (if equipped)



Lane Keeping Assist detects the lane markers and road edge on the road with a front view camera at the front windshield, and assists the driver's steering to help keep the vehicle in the lanes.

When the function detects the vehicle straying from its lane or road, it alerts the driver with a visual and audible warning, while applying a slight counter-steering torque, trying to prevent the vehicle from moving out of its lane.

⚠ WARNING

- Driver is responsible for being aware of surroundings and steering the vehicle for safe driving practices.
- Do not steer the steering wheel suddenly when the steering wheel is being assisted by the function.
- Lane Keeping Assist helps prevent the driver from moving out of the lane or road unintentionally by assisting the driver's steering. If the driver intentionally drive on one side of the driving lane, a continuous steering force may occur.

However, Lane Keeping Assist is just a convenience function and the steering wheel is not always controlled. While driving, the driver should pay attention to the steering wheel.

- The operation of Lane Keeping Assist can be canceled or not work properly according to road condition and surroundings. Always be cautious when driving.
- Do not disassemble a front view camera temporarily for tinted window or attaching any types of coatings and accessories.

If you disassemble the camera and assemble it again, have the function checked by a professional workshop. Kia recommends to visit an authorized Kia dealer/service partner and have the function checked to need a calibration.

- When you replace the windshield glass, front view camera or related parts of the steering, have the function checked by a professional workshop.

Kia recommends to visit an authorized Kia dealer/service partner and have the function checked to need a calibration.

- The function detects lane markers and controls the steering wheel by a front view camera, therefore, if the lane markers and road edge are hard to detect, the function may not work properly. Always be cautious when using the function.
- When the lane markers and road edge are hard to detect, please refer to "Limitations of Lane Keeping Assist" on page 6-50.
- Do not remove or damage the related parts of Lane Keeping Assist.
- Do not place objects on the crash pad that reflects light such as mirrors, white paper, etc. it may cause malfunction of Lane Keeping Assist if the sunlight is reflected.

- You may not hear warning sound of Lane Keeping Assist because of the excessive audio sound.
- While other beeps such as the seat belt warning sound are in operation and override Lane Keeping Assist alarming function, Lane Keeping Assist beeps may not occur.
- If the vehicle speed is high, steering torque for assistance will not be enough to keep your vehicle within the lane. If so, the vehicle may move out of its lane. Obey speed limit when using Lane Keeping Assist.
- If you attach objects to the steering wheel, the function may not assist steering.
- If you attach objects to the steering wheel, hands off alarm may not work properly.

To activate/deactivate Lane Keeping Assist

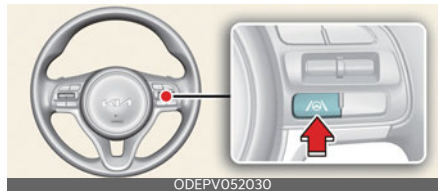

To activate/deactivate Lane Keeping Assist, with the vehicle in the ON position, press and hold the Lane Driving Assist button located on the steering wheel to turn off Lane Keeping Assist. Press and hold the button again to turn on the function.

The indicator (🚗) in the cluster display will initially appear white or green. If you press and hold the Lane Driving Assist button located on the steering wheel, Lane Keeping Assist will be

turned off and the indicator on the cluster display will go off.

* NOTICE

When Lane Keeping Assist is turned off with the Lane Driving Assist button, Lane Safety settings will turn off.

Lane Keeping Assist settings

With the vehicle in ON position, select or deselect **User settings** → **Driver assistance** → **Lane safety** from the Settings menu to set whether or not to use each function.

- If you select **Lane Keeping Assist**, Lane Keeping Assist guides the driver to keep the vehicle within the lanes. It rarely controls the steering wheel, when the vehicle drives well inside the lanes. However, it starts to control the steering wheel, when the vehicle is about to deviate from the lanes.
- If you select **Lane Departure Warning**, Lane Departure Warning alerts the driver with a visual and acoustic warning when the function detects the vehicle leaving the lane. In this mode, the steering wheel will not be controlled. When the vehicle's front wheel contacts the inside edge of lane line, Lane Keeping Assist issues the lane departure warning.
- If you select **Off**, Lane Keeping Assist deactivates.

Lane Keeping Assist activation

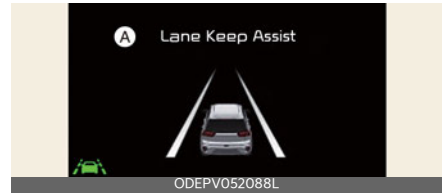

A: Lane Keep Assist

- To see Lane Keeping Assist screen on the LCD display in the cluster, Tab to the Driving Assist mode ().
- For further details, refer to "LCD display" on page 5-31.
- After Lane Keeping Assist is activated, if lane marker is detected, vehicle speed is over 60 km/h (37 mph) and all the activation conditions are satisfied, a green steering wheel indicator will illuminate and the steering wheel will be controlled.

⚠ WARNING

Lane Keeping Assist is a function to help prevent the driver from leaving the lane. However, the driver should not solely rely on the function but always check the road conditions when driving.

Lane marker undetected

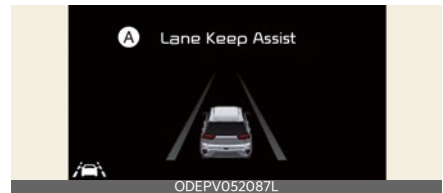

A: Lane Keep Assist

Lane marker detected



A: Lane Keep Assist

If the speed of the vehicle is over 60 km/h (37 mph) and the function detects lane markers, the color changes from grey to white.

Warning

Left lane



A: Lane Keep Assist

Right lane



A: Lane Keep Assist

To warn the driver that the vehicle is departing from the projected lane in front, the green () indicator light will blink on the cluster, the lane line will blink on the cluster depending on which direction the vehicle is veering, and an audible warning will sound.



A: Keep hands on steering wheel

If the driver takes hands off the steering wheel for several seconds while Lane Keeping Assist is activated, the function will warn the driver.

WARNING

- The hands-off warning message may appear late according to road conditions. Therefore, always have your hands on the steering wheel while driving.
- If you hold the steering wheel lightly, the function would generate hands off warning because Lane Keeping Assist can treat the situation as you do not grab the wheel.

WARNING

- The driver is responsible for accurate steering.
- Even though the steering is assisted by the function, the driver may control the steering wheel.
- Turn off the function and drive the vehicle in below situations.
 - In bad weather
 - In bad road condition
 - When the steering wheel needs to be controlled by the driver frequently.
 - When towing a vehicle or trailer.

- The steering wheel may feel heavier when the steering wheel is assisted by the function than when it is not.

* NOTICE

- Even though the steering is assisted by the function, the driver may control the steering.
- The steering wheel may feel heavier when the steering wheel is assisted by the function than when it is not.

Non-operating conditions of Lane Keeping Assist

- You change lanes with the turn signal.
 - Using the turn signal to change lanes.
 - If you change lanes without the turn signal on, the steering wheel might be controlled.
- Lane Keeping Assist can transit to steering assist mode when the car is near to middle of the lane after function on or the lane was changed. Lane Keeping Assist can not assist steering if the vehicle follows lane marker too close continuously before transition to steering assist mode.
- The control of ESC (Electronic Stability Control) or VSM (Vehicle Stability Management) is activated.
- The steering will not be assisted when your drive fast on a sharp curve.
- The steering will not be assisted when vehicle speed is below 55 km/h (34 mph) and over 200 km/h (125 mph).
- The steering will not be assisted when you change lanes fast.
- The steering will not be assisted when you brake suddenly.

- The steering will not be assisted when the lane is very wide or narrow.
- The steering will not be assisted when only one side lane marker is detected.
- There are more than two lane markers such as a construction area.
- Radius of a curve is too small.
- When you turn steering wheel suddenly, Lane Keeping Assist will be disabled temporarily.
- Driving on a steep slope or hill.

Lane Keeping Assist malfunction

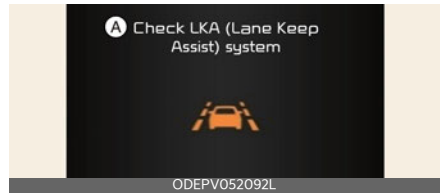

A: Check LKA (Lane Keep Assist) system

If there is a problem with the function a message will appear. If the problem continues Lane Safety indicator will appear. Lane Safety indicator (yellow) will appear if Lane Keeping Assist is not working properly.

In this case, have the function checked by a professional workshop. Kia recommends to visit an authorized Kia dealer/service partner.

Limitations of Lane Keeping Assist

The driver must be cautious in the below situations may not work properly when recognition of the lane marker is poor or limited:

When lane and road condition is poor

- It is difficult to distinguish the lane marker or road edge from road when the lane marker or road edge is covered with dust or sand.
- It is difficult to distinguish the color of the lane marker from road.
- There is something looks like a lane marker.
- The lane marker or road edge is indistinct or damaged.
- The number of lanes increases/ decreases or the lane lines are crossing (Driving through a toll plaza/toll gate, merged/divided lane).
- There are more than two lane markers.
- The lane marker is very thick or thin.
- The lane marker or road edge is not visible due to snow, rain, stain, a puddle or other factors.
- A shadow is on the lane marker or road edge because of a median strip, guardrail, noise barriers and others.
- When the lane markers are complicated or a structure substitutes for the lines such as a construction area.
- There are crosswalk signs or other symbols on the road.
- The lane suddenly disappears such as at the intersection.
- The lane marker or road edge in a tunnel is covered with dirt or oil and etc.
- The lane is very wide or narrow.

When external condition is intervened

- The brightness of outside changes suddenly when entering/existing a tunnel or passing under a bridge.
- The headlamps are not on at night or in a tunnel, or light level is low.
- There is a boundary structure in the roadway.
- The light of street, sun, oncoming vehicle and so on reflects from the water on the road.
- When light shines brightly in the reverse direction you drive.
- Road surface is not even.
- The distance from the vehicle ahead is very short or the vehicle ahead drives hiding the lane line or road edge.
- You drive on a steep grade or a sharp curve.
- The vehicle vibrates heavily.
- The temperature near inside mirror is very high due to direct sun light and etc.

When front visibility is poor

- The lens or windshield is covered by strange materials.
- The sensor cannot detect the lane because of fog, heavy rain or snow.
- The windshield is fogged by humid air in the vehicle.
- Putting something on the crash pad and etc.

WARNING

Lane Keeping Assist is a function to help prevent the driver from leaving the lane. However, the driver should not solely rely on the function but always take the necessary actions for safe driving practices.

When there is a problem with the function do one of the following:

- Turn the function on after turning the vehicle off and on again.
- Check if the vehicle is in ON position.
- Check if the function is affected by the weather. (ex: fog, heavy rain, etc.)
- Check if there is foreign matter on the camera lens

If the problem is not solved, have the function checked by a professional workshop. Kia recommends to visit an authorized Kia dealer/service partner.

Blind-Spot Collision Warning (BCW) (if equipped)

Blind-Spot Collision Warning uses rear corner radar sensors in the rear bumper to monitor and warn the driver of an approaching vehicle in the driver's blind spot area.

1. Blind-Spot Area



It warns by detecting the vehicles in the blind spots.

The blind spot detection range varies relative to vehicle speed.

Note that if your vehicle is traveling much faster than the vehicles around you, the warning will not occur.

2. Closing at high speed

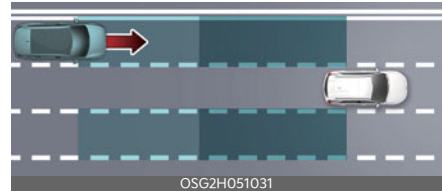

Blind-Spot Collision Warning will warn you when a vehicle is approaching in an adjacent lane at a high rate of speed. If the driver activates the turn signal when the function detects an oncoming vehicle, the function sounds an audible warn.

⚠ WARNING

- Blind-Spot Collision Warning is a supplemental function to assist you. Do not entirely rely on the function. Always pay attention, while driving, for your safety.

- Always be aware of road conditions while driving and be warn for unexpected situations even though Blind-Spot Collision Warning is operating.
- Blind-Spot Collision Warning is not a substitute for proper and safe driving. Always drive safely and use caution when changing lanes or backing up the vehicle. Blind-Spot Collision Warning may not detect every object alongside the vehicle.

Blind-Spot Collision Warning setting and activation

Settings

- The driver can activate the function by placing the vehicle to the ON position.
- If you press the Blind-Spot Safety button the indicator on the button extinguishes and the function deactivates.



- If you press the Blind-Spot Safety button while the function is canceled the indicator on the button appears and the function activates. In this case, the function returns to the state before the vehicle turned off. When the function is initially turned on and when the motor is turned off then on again while the function is in activation, the warning light will appear for 3 seconds on the outside rear view mirror.
- If the vehicle is turned off then on again, the function maintains the previous state.

Setting the warning sound of Blind-Spot Collision Warning

The driver can select the warning sound of Blind-Spot Collision Warning in the User settings in the LCD display by selecting **User settings** → **Driver assistance** → **BCW sound (Blind-Spot Collision Warning)**.

Operating conditions

The function enters the ready status, and the following conditions are satisfied:

The function will activate when:

- The function is on
- Vehicle speed is above 30 km/h (18.6 mph)
- Other vehicles are detected in the rear side

WARNING

- Always check the road condition while driving for unexpected situations even though Blind-Spot Collision Warning is operating.
- Blind-Spot Collision Warning is a supplemental function to assist you. Do not entirely rely on the function. Always pay attention, while driving, for your safety.
- Blind-Spot Collision Warning is not a substitute for proper and safe driving. Always drive safely and use caution when changing lanes or backing the vehicle up. Blind-Spot Collision Warning may not detect every object alongside the vehicle.

Warning message and function control

Blind-Spot Collision Warning

Vehicle detection



If a vehicle is detected within the boundary of the function, a warning light will appear on the outside rear view mirror. Once the detected vehicle is no longer within the blind spot area, the warning will turn off according to the driving conditions of the vehicle.

Collision warning



A warning chime to warn the driver will activate when:

1. At the First stage warning (the warning light appear on the outside review mirror AND
2. The turn signal is applied (same side as where the vehicle is being detected).

When this warning is activated, the warning light on the outside rear view mirror will also blink. And a warning chime will sound.

If you turn off the turn signal indicator, the second stage warning will be deactivated.

Once the detected vehicle is no longer within the blind spot area, the warning will turn off according to the driving conditions of the vehicle.

⚠ WARNING

- The warning light on the outside rear view mirror will appear whenever a vehicle is detected at the rear side by the function.
To avoid accidents, do not focus only on the warning light and neglect to check the vehicle surroundings.
- Drive safely even though the vehicle is equipped with Blind-Spot Collision Warning. Do not solely rely on the function but check your surroundings before changing lanes or backing the vehicle up.
- The function may not alert the driver in some situations so always check your surroundings while driving.

⚠ CAUTION

- The driver should always use extreme caution while operating the vehicle, whether or not the warning light on the outside rear view mirror illuminates or there is a warning alarm.
- Playing the vehicle audio system at high volume may offset Blind-Spot Collision Warning warning sounds.
- The warning of Blind-Spot Collision Warning may not sound while other function's warning sounds.

Detecting sensor

Rear corner radar



The rear corner radars are the sensors inside the rear bumper for detecting the side/rear areas. Always keep the rear bumper clean for proper operation of the function.

CAUTION

- The function may not work properly when the bumper has been damaged, or if the rear bumper has been replaced or repaired.
- The sensing range differs somewhat according to the width of the road. When the road is narrow, the function may detect other vehicles in the next lane.
- The function may turn off due to strong electromagnetic waves.
- Always keep the sensor or near the sensor clean.
- Never arbitrarily disassemble the sensor component nor apply any impact on the sensor component.
- Be careful not to apply unnecessary force on the radar sensor or sensor cover. If the sensor is forcibly moved out of proper alignment, the function may not operate correctly.

In this case, a warning message may not be displayed. Take your vehicle to a professional workshop and have the function checked. Kia recommends to visit an authorized Kia dealer/service partner.

- Do not apply foreign objects such as a bumper sticker or a bumper guard near the radar sensor or apply paint to the sensor area. Doing so may adversely affect the performance of the sensor.
- Never install any accessories or stickers on the front windshield, nor tint the front windshield.
- Pay extreme caution to keep the camera sensor out of water.
- Never locate any reflective objects (i.e. white paper, mirror) over the crash pad. Any light reflection may cause a malfunction of the function.
- The genuine Kia rear bumpers which the Rear corner radar sensors are mounted are parts with quality and performance ensured. If arbitrarily applying paint on or changing the bumper, the Blind-Spot Collision Warning may not function properly. Use only Kia Genuine Parts or those of an equivalent standard with proven quality and performance to repair or replace the bumper.

Turning off Blind-Spot Collision Warning when a trailer or carrier is installed

- Press the Blind-Spot Safety button (the indicator on the button extinguish)
- If you use Blind-Spot Collision Warning, remove a trailer or carrier.

When Blind-Spot Collision Warning canceled warning message is displayed in the cluster, check to make sure that the rear bumper is free from any dirt or snow in the areas where the sensor is located. Remove any dirt, snow, or for-

foreign material that could interfere with the radar sensors.

After any dirt or debris is removed, Blind-Spot Collision Warning should operate normally after about 10 minutes of driving the vehicle.

If the function still does not operate normally, Kia recommend that you have your vehicle inspected by an authorized Kia dealer/service partner.

Blind-Spot Collision Warning malfunction and limitations

Blind-Spot Collision Warning disabled



A: Blind-spot safety systems disabled. Radar blocked

This warning message may appear when:

- One or both of the sensors on the rear bumper is blocked by dirt or snow or a foreign object.
- Driving in rural areas where the sensor does not detect another vehicle for an extended period of time.
- When there is inclement weather such as heavy snow or rain.

If any of these conditions occur, the light on the Blind-Spot Safety button and the function will turn off automatically.

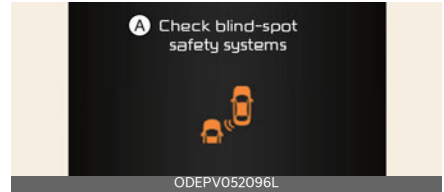

A: Check blind-spot safety systems

If there is a problem with Blind-Spot Collision Warning, a warning message will appear and the light on the switch will turn off. The function will turn off automatically.

In this case, have the function checked by a professional workshop. Kia recommends to visit an authorized Kia dealer/service partner.

Limitations of Blind-Spot Collision Warning

The driver must be cautious in the below situations, because the function may not detect other vehicles or objects in certain circumstances.

- When a trailer or carrier is installed.
- The vehicle drives in inclement weather such as heavy rain or snow.
- The sensor is polluted with rain, snow, mud, etc.
- The rear bumper where the sensor is located is covered with a foreign object such as a bumper sticker, a bumper guard, a bike rack, etc.
- The rear bumper is damaged, or the sensor is out of the original default position.
- The vehicle height gets lower or higher due to heavy loading in a tail-gate, abnormal tire pressure, etc.
- When the temperature of the rear bumper is high.

- When the sensors are blocked by other vehicles, walls or parking-lot pillars.
- The vehicle drives on a curved road.
- The vehicle drives through a tollgate.
- The road pavement (or the peripheral ground) abnormally contains metallic components (i.e. possibly due to subway construction).
- There is a fixed object near the vehicle, such as a guardrail.
- While going down or up a steep road where the height of the lane is different.
- Driving on a narrow road where trees or grass or overgrown.
- Driving in rural areas where the sensor does not detect another vehicle or structure for an extended period of time.
- Driving on a wet road.
- Driving on a road where the guardrail or wall is in double structure.
- A big vehicle is near such as a bus or truck.
- When the other vehicle approaches very close.
- When the other vehicle passes at a very fast speed.
- While changing lanes.
- If the vehicle has started at the same time as the vehicle next to you and has accelerated.
- When the vehicle in the next lane moves two lanes away from you OR when the vehicle two lanes away moves to the next lane from you.
- A motorcycle or bicycle is near.
- A flat trailer is near.

- If there are small objects in the detecting area such as a shopping cart or a baby stroller.
- If there is a low height vehicle such as a sports car.
- The brake pedal is depressed.
- ESC (Electronic Stability Control) is activated.
- ESC (Electronic Stability Control) malfunctions.
- The tire pressure is low or a tire is damaged.
- The brake is reworked.
- The vehicle abruptly changes driving direction.
- The vehicle makes sharp lane changes.
- The vehicle sharply stops.
- Temperature is extremely low around the vehicle.
- The vehicle severely vibrates while driving over a bumpy road, uneven/bumpy road, or concrete patch.
- The vehicle drives on a slippery surface due to snow, water puddle, or ice.
- Driving on a curved road



Blind-Spot Collision Warning may not operate properly when driving on a curved road. In certain instances the function may not detect the vehicle in the next lane.

Always pay attention to road and driving conditions, while driving.



Blind-Spot Collision Warning may not operate properly when driving on a curved road. In certain instances the function may recognize a vehicle in the same lane.

Always pay attention to road and driving conditions, while driving.

- Driving where the road is merging/dividing



Blind-Spot Collision Warning may not operate properly when driving where the road is merging/dividing. In certain instances the function may not detect the vehicle in the next lane.

Always pay attention to road and driving conditions, while driving.

- Driving on a sloped road

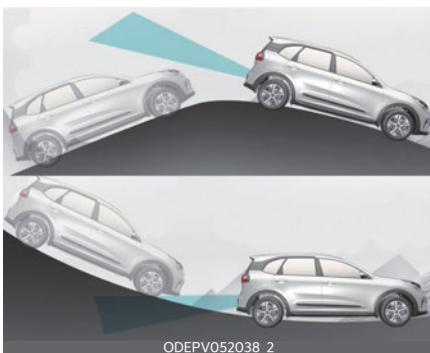

Blind-Spot Collision Warning may not operate properly when driving on a slope. In certain instances the function may not detect the vehicle in the next lane.

Also, in certain instances the function may wrongly recognize the ground or structures.

Always pay attention to road and driving conditions, while driving.

- Driving where the heights of the lanes are different

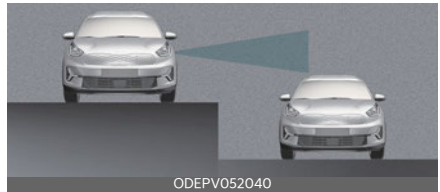

Blind-Spot Collision Warning may not operate properly when driving where the heights of the lanes are different. In certain instances, the function may not detect the vehicle on a road with different lane heights (underpass joining section, grade separated intersections, etc.). Always pay attention to road and driving conditions, while driving.

- Driving where there is a structure beside the road

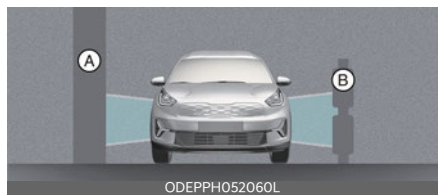

[A]: noise barrier, [B]: guardrail

Blind-Spot Collision Warning may not operate properly when driving where there is structure beside the road.

In certain instances, the function may wrongly recognize the structures (noise barriers, guardrail, double guardrail, median strip, bollard, street light, road sign, tunnel wall, etc.) beside the road.

Always pay attention to road and driving conditions, while driving.

Manual Speed Limit Assist (MSLA) (if equipped)

You can set the speed limit when you do not want to drive over a specific speed.

If you drive over the preset speed limit, the warning function operates (set speed limit will blink and chime will sound) until the vehicle speed returns within the speed limit.

* NOTICE

While Manual Speed Limit Assist is in operation, Cruise Control cannot be activated.

To set speed limit:

1. Press the Driving Assist button twice on the steering wheel, to turn the function on.

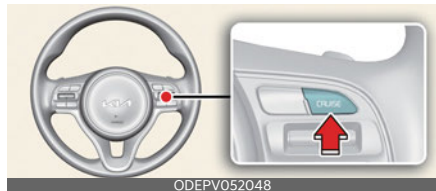

The speed limit indicator light will appear.

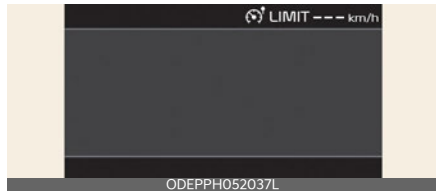

2. Push the switch down (to SET-).

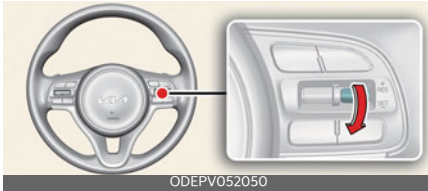

ODEPV052050

3. Push the switch up (to RES+) or down (to SET-), and release it at the desired speed. Push the switch up (to RES+) or down (to SET-) and hold it. The speed will increase or decrease by 5 km/h (3 mph).



ODEPV052049

Push the switch up (to RES+) or down (SET-) and release it immediately.

The speed will increase or decrease by 1 km/h. The set speed limit will display on the instrument cluster.

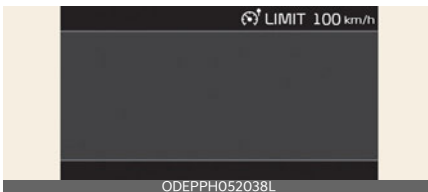

ODEPPH052038L

The set speed limit will be displayed. To drive over the preset speed limit you must depress hard on the accelerator pedal (more than approximately 80%) until the kickdown mechanism (if equipped) works with a clicking noise. Then the set speed limit will blink and chime will sound until you return the vehicle speed within the speed limit.

* NOTICE

- Depressing the accelerator pedal less than approximately 50%, the vehicle will not speed over the preset speed limit but maintain the vehicle speed within the speed limit.
- A clicking noise heard from the kick down mechanism by depressing the accelerator pedal fully is a normal condition.

Temporarily pausing Manual Speed Limit Assist



ODEPPH052074L

Press the (||) switch to temporarily pause the set speed limit. The set speed limit will turn off but the Speed Limit (LIMIT) indicator will stay on.

Resuming Manual Speed Limit Assist



ODEPPH052075L_3

To resume Manual Speed Limit Assist after the function was paused, operate the (+), (-), (||) switch.

If you push the (+) switch up or (-) switch down, vehicle speed will be set to the current speed on the cluster.

If you press the (|||) switch, vehicle speed will resume to the preset speed.

To turn off Manual Speed Limit Assist, do one of the following:

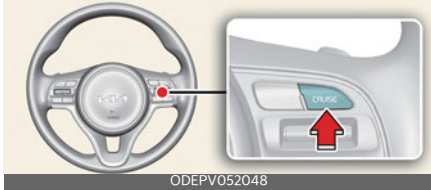

- Press the Driving Assist button.
- Turn the vehicle off.

If you press the CANCEL (O) button once, the set speed limit will cancel, but it will not turn the function off. If you wish to reset the speed limit, push the switch up (to RES+) or down (to SET-) to the desired speed.

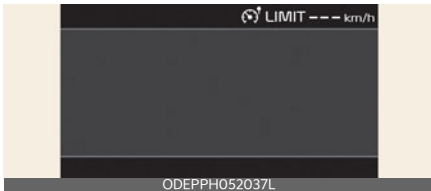

CAUTION

The "---" indicator will blink if there is a problem with Manual Speed Limit Assist. In this case, have the function checked by a professional workshop. Kia recommends to visit an authorized Kia dealer/service partner.

Intelligent Speed Limit Warning (ISLW) (if equipped)



The function displays the information of speed limit and no passing restriction to the driver in both the instrument cluster and navigation screen. Intelligent Speed Limit Warning detects traffic signs with camera function attached on the top of the windscreen.

Intelligent Speed Limit Warning also utilizes the navigation information to display the speed limit information.

WARNING

- Intelligent Speed Limit Warning is only an aid and is not always able to correctly display speed limits and overtaking restrictions.
- The driver always keeps the responsibility not to exceed the maximum allowed speed
- Do not place any accessories, stickers or tint the windshield near the rear view mirror.
- The function detects traffic signs and displays speed limit information by a camera therefore, if traffic signs are hard to detect, the function may not work properly.
Please refer to "Driver's Attention" on page 6-63.
- Do not remove any camera parts or apply impact.
- Do not place objects on the dashboard that reflects light such as mirrors, white paper, etc. The function

may malfunction if the sunlight is reflected.

- The function is not available in all countries.

Intelligent Speed Limit Warning activation/deactivation

- Intelligent Speed Limit Warning Setting method:
Cluster **User settings** → **Driver assistance** → **Speed Limit Warning**
- The information of speed limit and no passing restriction will appear on the cluster using a symbol if you have activated **Speed Limit Warning** in User Settings of cluster.
- If Intelligent Speed Limit Warning is activated in the navigation settings, the information is also displayed on the navigation screen.

Operation

- If a traffic sign that is relevant to your vehicle is passed, the function displays the information of the speed limits and no passing restrictions to the driver.
- When the driver turns on the ignition, the function displays the information of the speed limit that was stored before the vehicle has been turned off.

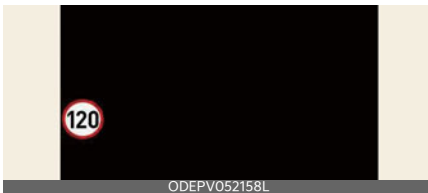

- Sometimes different speed limits are displayed for the same road. The information displayed depending on the situation, because, traffic signs

with additional sign (e.g rainy, arrow, etc.) are also detected and compared with an additional interior data(e.g wiper operation, turn signal, etc.).

- The function can update the speed limit information without visible speed limit signs in the following situations.
 - When you change your driving direction by turning right or left or by a U-turn.
 - hen the road changes. (e.g. from highway to country road, etc.)
 - When you enter or exit a into town or village.

* NOTICE

If the speed limit unit is different between cluster and navigation, check the speed unit setting in the navigation menu.

Display

- If the function doesn't have a reliable Speed Limit, the following symbol is displayed in both the instrument cluster and navigation screen.

No reliable speed limit information



- If the function detect no passing sign, no passing is displayed in both the instrument cluster and navigation screen.

No passing sign



- After passing 'end of a speed limit' sign, Intelligent Speed Limit Warning provides information from navigation to inform driver of perhaps afterwards applicable speed limit.

End of a speed limit sign



Warning message

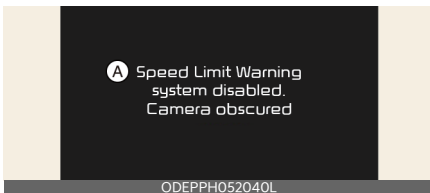

A: Speed Limit Warning system disabled. Camera obscured

The message will appear when camera's field of view is covered by some objects. The function stops until the field of view is normal.

Check the windshield around the camera view area.

If the function does not work normally even though camera's field of view is cleared, have the function checked by a professional workshop. Kia recommends to visit an authorized Kia dealer/service partner.



A: Check Speed Limit Warning system

When Intelligent Speed Limit Warning is not working properly, the warning message will come on for a few second. After the message disappears, the master warning light will appear.

In this case, have the function checked by a professional workshop.

Kia recommends to visit an authorized Kia dealer/service partner.

The function may not fully operate and provide correct information in the following situations.

- Traffic signs are positioned on sharp curve.
- Poorly positioned traffic sign. (e.g. Rotated, shaded by any object, damaged, etc.)
- Concealed traffic signs by other vehicle.
- Broken LED traffic signs.
- Poor weather like snow, rain, fog
- Reflected glare around and/or on the traffic sign.
- There is insufficient illumination of the traffic signs in the night.
- There is bright lights around traffic signs.
- There is dirt, ice or frost on the windshield in the area of the camera.
- When camera field of view is covered by objects such as a sticker, paper, leaf fall.
- When driving very close to the vehicle in front of you.

- When navigation system has malfunction.
- When bus or trucks attached with a speed sticker are passing you.
- When you are at a certain location not covered by the navigation function.
- When the navigation function is not updated to the latest map version.

Driver's Attention

The driver must be cautious in the below situations for the function may not assist the driver and may not work properly.

- Do not stick or attach anything to the windshield in front of the camera as this may reduce effectiveness or cause one more of the function dependent on the camera to stop working.
- Keep the windshield in the area behind the interior rear view mirror clean.
- Do not place reflective materials, such as white paper or a mirror, on the instrument panel.
- Do not strike or damage the areas around the camera unit.
- Do not touch the camera lens or remove the screw located on the camera unit.
- The function does not work in all situations but is designed merely as a supplementary aid.
- The function assists the driver and does not replace the human eye.
- The driver always bears ultimate responsibility for ensuring that the vehicle is driven safely and that applicable road traffic rules and regulations are followed.

Driver Attention Warning (DAW) (if equipped)

Driver Attention Warning is to warn the driver with any hazardous driving situations upon detecting the driver's attention level or inattentive driving practices.

Driver Attention Warning

Settings

- Driver Attention Warning is set to be in the OFF position, when your vehicle is first delivered to you from the factory.
- To turn ON Driver Attention Warning, turn on the vehicle, and then select **User settings** → **Driver assistance** → **DAW (Driver Attention Warning)** → **High sensitivity/Normal sensitivity/Off** on the LCD display.
- The driver can select Driver Attention Warning mode.
 - **High sensitivity:** Driver Attention Warning alerts the driver of his/her fatigue level or inattentive driving practices faster than Normal mode.
 - **Normal sensitivity:** Driver Attention Warning alerts the driver of his/her fatigue level or inattentive driving practices.
 - **Off:** Driver Attention Warning is deactivated.
- The set-up of Driver Attention Warning will be maintained, as selected, when the vehicle is restarted.

Display of the driver's attention level



A: Attention level

1 Last Break

- The driver can monitor their driving conditions on the LCD display.
 - Select **User settings** mode and then **Driver assistance** on the LCD display. (For more information, refer to "LCD display" on page 5-31.)
- Driver's attention level is displayed on the scale of 1 to 5. The lower the level is, the more inattentive the driver is.
- The level decreases when the driver does not take a break for a certain period of time.
- When the driver turns on the function while driving, it displays **Last Break time** and level reflected that.

Take a break

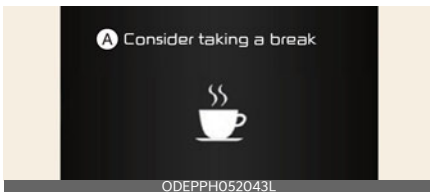

A: Consider taking a break

- The message appears on the LCD display and a warning sounds in order to suggest the driver to take a break, when the driver's attention level is below 1.

- Driver Attention Warning does not suggest the driver to take a break, when the total driving time is shorter than 10 minutes.

Resetting the function

- The last break time is set to 00:00 and the driver's attention level is set to 5 (very attentive) when the driver resets Driver Attention Warning.
- Driver Attention Warning resets in the following situations.
 - The vehicle is turned OFF.
 - The driver unfastens the seat belt and then opens the driver's door.
 - Stop lasting more than 10 minutes.
- Driver Attention Warning operates again, when the driver restarts driving.

Function standby



A: Driver Attention Warn.

1 Standby

2 Last Break

Driver Attention Warning enters the ready status and displays the **Standby** screen in the following situations.

- The camera sensor keeps failing to detect the lanes.
- Driving speed remains 0~180 km/h (0~112 mph)

Driver Attention Warning malfunction

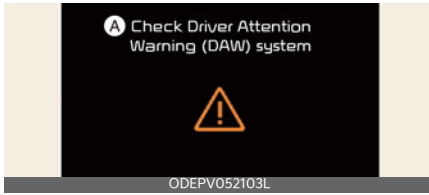

A: Check Driver Attention Warning (DAW) system

When the warning message appears, the function is not working properly. In this case, have the function checked by a professional workshop. Kia recommends to visit an authorized Kia dealer/service partner.

WARNING

- Driver Attention Warning is not a substitute for safe driving practices, but a convenience function only. It is the responsibility of the driver to always drive cautiously to prevent unexpected and sudden situations from occurring. Pay attention to the road conditions at all times.
- It may suggest a break according to the driver's driving pattern or habits even if the driver doesn't feel fatigued.
- The driver, who feels fatigued, should take a break, even though there is no break suggestion by Driver Attention Warning.

*** NOTICE**

Driver Attention Warning utilizes the front view camera on the front windshield for its operation. To keep the front view camera in the best condition, you should observe the followings:

- Do not disassemble front view camera temporarily for tinted window or

attaching any types of coatings and accessories. If you disassemble a camera and assemble it again, have the function checked by a professional workshop. Kia recommends to visit an authorized Kia dealer/service partner and have the function checked to need a calibration.

- Do not locate any reflective objects (i.e. white paper, mirror) over the dashboard. Any light reflection may cause a malfunction of Driver Attention Warning.
- Pay extreme caution to keep the front view camera out of water.
- Do not arbitrarily disassemble the front view camera assembly, nor apply any impact on the front view camera assembly.
- Playing the vehicle audio system at high volume may offset Driver Attention Warning warning sounds.

CAUTION

Driver Attention Warning may not properly operate with limited alerting in the following situations:

- The lane detection performance is limited. (For more information, refer to "Lane Keeping Assist (LKA) (if equipped)" on page 6-45.)
- The vehicle is violently driven or is abruptly turned for obstacle avoidance (e.g. construction area, other vehicles, fallen objects, bumpy road).
- Forward drivability of the vehicle is severely undermined (possibly due to wide variation in tire pressures, uneven tire wear-out, toe-in/toe-out alignment).
- The function will not operate for about 15 seconds when restarting the

vehicle or initializing the front camera such as rebooting, etc.

- Intentionally frequent lane cut-in.
- The vehicle drives on a curvy road.
- The vehicle drives on a bumpy road.
- The vehicle drives through a windy area.
- The vehicle is controlled by the following driving assist functions:
 - Forward Collision-Avoidance Assist
 - Lane Keeping Assist
 - Smart Cruise Control

Leading vehicle departure warning

This function reminds the driver the leading vehicle's driving departure after stopping.

Function setting and operating conditions

With the vehicle ON, the Leading vehicle departure warning function turns on and gets ready to be activated when the **User settings** → **Driver assistance** → **DAW (Driver Attention Warning)** → **Leading vehicle departure alert** is selected on the cluster. The function stops operation when the setting is deactivated. However, if the vehicle is turned off then on again, the function maintains the previous state.

Function activation

If the driver does not take action for a certain period of time after the vehicle in front departs, **Leading vehicle is driving away** message is displayed on the cluster.

⚠ WARNING

- The function is a driver assistant device and it may not warn the driver even warn the leading vehicle's departure.
- Even the function warn the driver the leading vehicle's departure, always check the traffic condition by yourself before moving the vehicle.

* NOTICE

The function may not warn or may not work properly when:

- A pedestrian or a bicycle is ahead
 - A car cut in ahead.
 - Meet a traffic jam during the curve or right turn driving.
 - Busy road such as reducing lanes.
 - Stopping at a shoulder, rest area or a parking lot.
-

Cruise Control (CC) (if equipped)

Type A



Type B



- 1 CRUISE indicator
- 2 Cruise set indicator

Cruise Control allows you to program the vehicle to maintain a constant speed without depressing the accelerator pedal.

This function is designed to function above approximately 30 km/h (20 mph).

WARNING

- If Cruise Control is left on, (CRUISE indicator light appears), Cruise Control can be switched on accidentally. Keep Cruise Control off when Cruise Control is not in use, to avoid inadvertently setting a speed.
- Use Cruise Control only when traveling on open highways in good weather.
- Do not use Cruise Control when it may not be safe to keep the vehicle at a constant speed, for instance, driving in heavy or varying traffic, or on slippery (rainy, icy or snow covered) or

winding roads or over 6% uphill or downhill roads.

- Pay particular attention to the driving conditions whenever using Cruise Control.
- Be careful when driving downhill using Cruise Control, which may increase the vehicle speed.

*** NOTICE**

- During normal Cruise Control operation, when the SET switch is activated or reactivated after applying the brakes, Cruise Control will energize after approximately 3 seconds. This delay is normal.
- To activate Cruise Control, depress the brake pedal at least once after turning the vehicle to the ON position or starting the vehicle. This is to check if the brake switch which is important part to cancel Cruise Control is in normal condition.

Cruise Control operation switches



- 1 Driving Assist button: Turns Cruise Control on or off.
- 2 RES+: Resumes or increases Cruise Control speed.
- 3 SET-: Sets or decreases Cruise Control speed.
- 4 CANCEL (O): Cancels Cruise Control operation.

To set Cruise Control speed:

1. Press the Driving Assist button on the steering wheel to turn the function on. CRUISE indicator light will appear.

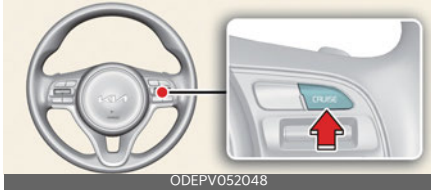

2. Accelerate to the desired speed, which must be more than approximately 30 km/h (20 mph).
3. Push the switch down (to SET-), and release it at the desired speed. The cruise set indicator light will illuminate. Release the accelerator pedal at the same time. Set speed will automatically be maintained.

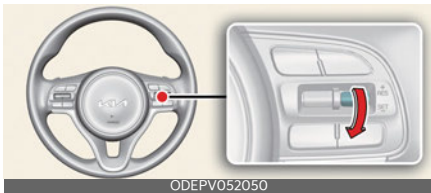

On a steep grade, the vehicle may slow down or speed up slightly while going downhill.

To increase Cruise Control set speed:

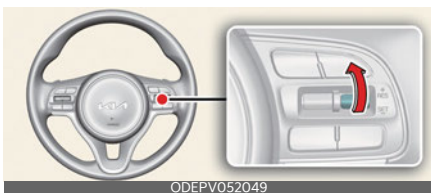

Follow either of these procedures:

- Push the switch up (to RES+) and hold it. Your vehicle will accelerate. Release the switch at the speed you want.

- Push the switch up (to RES+) and release it immediately. The cruising speed will increase by 1 km/h (1 mph) each time you push the switch up (to RES+) in this manner.

To decrease the cruising speed:



Follow either of these procedures:

- Push the switch (to SET-) and hold it. Your vehicle will gradually slow down. Release the switch at the speed you want to maintain.
- Push the switch down (to SET-) and release it immediately. The cruising speed will decrease by 1 km/h (1 mph) each time you push the switch down (to SET-) in this manner.

To temporarily accelerate with Cruise Control on:

If you want to speed up temporarily when Cruise Control is on, depress the accelerator pedal. Increased speed will not interfere with Cruise Control operation or change the set speed.

To return to the set speed, take your foot off the accelerator pedal.

To cancel Cruise Control, do one of the following:

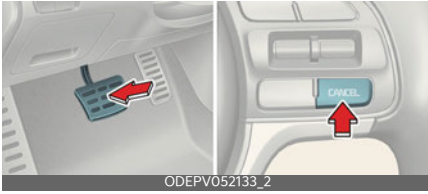

ODEPV052133_2

- Depress the brake pedal.
- Press the CANCEL (O) button located on the steering wheel.
- Decrease the vehicle speed lower than the memory speed by approximately 20 km/h (12 mph).
- Decrease the vehicle speed to less than approximately 25 km/h (15 mph).

Each of these actions will cancel Cruise Control operation (the cruise set indicator light will go off), but it will not turn the function off. If you wish to resume Cruise Control operation, push up the switch (to RES+) located on your steering wheel. You will return to your previously preset speed.

To resume cruising speed at more than approximately 30 km/h (20 mph).



ODEPV052049

If any method other than the Driving Assist button was used to cancel cruising speed and the function is still activated, the most recent set speed will automatically resume when the (RES+) switch is pushed.

It will not resume, however, if the vehicle speed has dropped below approximately 30 km/h (20 mph).

To turn Cruise Control off, do one of the following:

- Press the Driving Assist button (CRUISE indicator will turn off).
- If your vehicle equipped the speed limit, press the Driving Assist button twice. (CRUISE indicator will turn off.)
- Turn the vehicle off.

Both of these actions cancel Cruise Control operation. If you want to resume Cruise Control operation, repeat the steps provided on the previous page.

Smart Cruise Control (SCC) (if equipped)



- 1 CRUISE indicator
- 2 Set speed
- 3 Vehicle distance

Smart Cruise Control allows you to program the vehicle to maintain constant speed and distance detecting the vehicle ahead without depressing the accelerator or brake pedal.

To see the Smart Cruise Control screen on the LCD display on the cluster, select Driving Assist mode (). For more informations, refer to "LCD display" on page 5-31.

WARNING

For your safety, please read the owner's manual before using Smart Cruise Control.

* NOTICE

To activate Smart Cruise Control, depress the brake pedal at least once after turning the vehicle to the ON position or starting the vehicle. This is to check if the brake switch which is important part to cancel Smart Cruise Control is in normal condition.

Smart Cruise Control operation switches

Driving Assist button: Turns Smart Cruise Control on or off.

RES+: Resumes or increases Smart Cruise Control speed.

SET-: Sets or decreases Smart Cruise Control speed.

(): Sets vehicle distance.

CNCL (O): Cancels Smart Cruise Control operation.

To set Smart Cruise Control Speed:

1. Press the Driving Assist button to turn the function on. CRUISE indicator in the instrument cluster will appear.

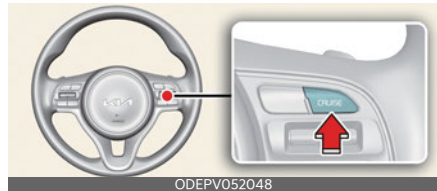

2. Accelerate to the desired speed. Smart Cruise Control speed can be set as follows:

- 10~160 km/h (5~100 mph): when there is no vehicle in front
- 0~160 km/h (0~100 mph): when there is a vehicle in front

3. Push the switch down (to SET-), and release it at the desired speed. The set speed and vehicle to vehicle distance on the LCD screen will appear.

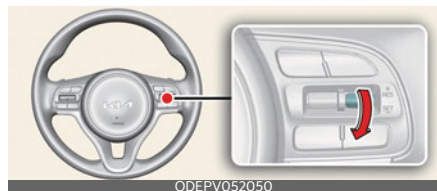

4. Release the accelerator pedal. The desired speed will automatically be maintained.

If there is a vehicle in front of you, the speed may decrease to maintain the distance to the vehicle ahead.

On a steep grade, the vehicle may slow down or speed up slightly while going uphill or downhill.

Vehicle speed may decrease on an downward slope and increase on an onward slope.

The speed will be set to 30 km/h (20 mph) when there is a vehicle ahead and your vehicle speed is 0~30 km/h (20 mph).

Also, the speed will be set to 30 km/h (20 mph) when there is no vehicles ahead and your vehicle speed is 10~30 km/h (5~20 mph).

Smart Cruise Control not operating conditions

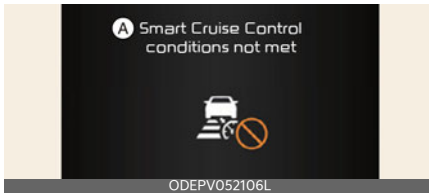

A: SCC (Smart Cruise Ctrl.) conditions not met

- The driver's door is opened.
- The vehicle is shifted to N (Neutral)/R (Reverse)/P (Park).
- The parking brake is applied.
- The vehicle speed is not within the specified SCC range.
- The ESC (Electronic Stability Control), TCS (Traction Control System) or ABS is operating.

- The ESC (Electronic Stability Control), TCS (Traction Control System) or ABS is off.
- The sensor cover is extremely contaminated.
- The motor performance is abnormal.
- Forward Collision-Avoidance Assist is activated.
- The front radar sensing data is out of limit.

To increase Smart Cruise Control set speed:



Follow either of these procedures:

- Push the switch up (to RES+), and hold it. Your vehicle set speed will increase by 10 km/h (5 mph). Release the switch at the speed you want.
- Push the switch up (to RES+), and release it immediately. The cruising speed will increase by 1 km/h (1 mph) each time you push the switch up (to RES+) in this manner.
- You can increase the set speed to 160 km/h (100 mph).

⚠ CAUTION

Check the driving condition before using the toggle switch. Driving speed sharply increases, when you push up and hold the switch.

To decrease Smart Cruise Control set speed:

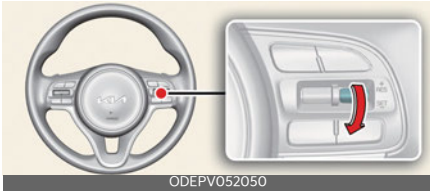

Follow either of these procedures:

- Push the switch down (to SET-), and hold it. Your vehicle set speed will decrease by 10 km/h (5 mph). Release the switch at the speed you want.
- Push the switch down (to SET-), and release it immediately. The cruising speed will decrease by 1 km/h (1 mph) each time you push the switch down (to SET-) in this manner.
- You can decrease the set speed to 30 km/h (20 mph).

To temporarily accelerate with Smart Cruise Control on:

If you want to speed up temporarily when Smart Cruise Control is on, depress the accelerator pedal. Increased speed will not interfere with Smart Cruise Control operation or change the set speed.

To return to set speed, take your foot off the accelerator.

If you push the switch down (to SET-) at increased speed, the increased cruising speed will be set again.

*** NOTICE**

Be careful when accelerating temporarily, because the speed is not controlled automatically at this time even if there is a vehicle in front of you.

Smart Cruise Control will be temporarily canceled when:

Canceled manually



Smart Cruise Control is temporarily canceled when the brake pedal is depressed or the CNCL (O) switch is pressed. Depress the brake pedal and press the CNCL (O) switch at the same time, when the vehicle is at a standstill. The speed and vehicle distance indicator on the cluster is disappeared and CRUISE indicator is appeared continuously.

Canceled automatically

SCC will automatically cancel in the following situations:

- The driver's door is opened.
- The gear is shifted to N (Neutral), R (Reverse) or P (Parking).
- The EPB (Electronic Parking Brake) is applied.
- The vehicle speed is over 170 km/h (110 mph)
- The ESC, ABS or TCS is operating.
- The ESC is turned off.
- The sensor or the cover is dirty or blocked with foreign matter.
- The accelerator pedal is continuously depressed for long time.
- The speed is in dangerous range.
- Smart Cruise Control has malfunctioned.

- When the braking control is operated for Forward Collision-Avoidance Assist
- The vehicle is stopped for more than 5 minutes.
- The vehicle stops and goes repeatedly for a long period of time.
- When the parking brake is locked.
- Vehicle has some problems.

Each of these actions will cancel Smart Cruise Control operation. (the set speed and vehicle distance on the LCD display will go off.) In a condition Smart Cruise Control is canceled automatically, Smart Cruise Control will not resume even though the (RES+) or (SET-) switch is pushed.

In a condition Smart Cruise Control is canceled automatically when the vehicle stops, the EPB will activate and the parking brake will be locked.

⚠ CAUTION

If Smart Cruise Control is canceled by other than the reasons mentioned, have the function checked by a professional workshop. Kia recommends to visit an authorized Kia dealer/service partner.

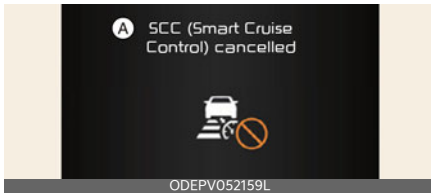

A: SCC (Smart Cruise Control) cancelled

⚠ CAUTION

If the function is automatically canceled, the warning chime will sound and a message will appear for a few seconds.

You must adjust the vehicle speed by depressing the accelerator or brake pedal according to the road condition ahead and driving condition.

Always check the road conditions. Do not rely on the warning chime.

To resume Smart Cruise Control set speed:



If any method other than the CNCL (O) switch was used to cancel cruising speed and the function is still activated, the cruising speed will automatically resume when you push the switch up (to RES+).

If you push the switch up (to RES+), the speed will resume to the recently set speed. However, if vehicle speed drops below 10 km/h (5 mph), it will resume when there is a vehicle in front of your vehicle.

*** NOTICE**

To reduce the risk of an accident, always check the road conditions when reactivating Smart Cruise Control using the (RES+) switch to ensure the road conditions permit safe use of Cruise Control.

To turn Smart Cruise Control off:

Press the Driving Assist button. (CRUISE indicator in the instrument cluster will go off).

When Smart Cruise Control is not needed, press the Driving Assist button and deactivate the function.

*** NOTICE**

The mode changes, as below, whenever the Driving Assist button is pressed.

- Function off → Smart Cruise Control → Manual Speed Limit Assist → Function off

⚠ WARNING

Take the following precautions:

- If Smart Cruise Control is left on, (CRUISE indicator in the instrument cluster appeared) Smart Cruise Control can be activated unintentionally. Keep Smart Cruise Control off (CRUISE indicator off) when Smart Cruise Control is not used.
- Do not leave the vehicle when it stop by Smart Cruise Control. If necessary to leave the vehicle, turn off Smart Cruise Control and change the gear to P (Parking) and engage the parking brake and off the vehicle while depressing the brake pedal.
Do not leave the vehicle when it was stopped by Smart Cruise Control. If it is necessary to leave the vehicle, turn off the Smart Cruise Control, change the gear shift to P (Parking), engage the parking brake and turn off the motor while depressing the brake pedal.
- Use Smart Cruise Control only on the good traffic condition road. Do not use Smart Cruise Control in the fol-

lowing situations because the high risk of an accident.

- Highway interchange and tollgate
- Road surrounded by abnormally multiple steel constructions (subway construction, steel tunnel, etc.)
- Parking lot
- Lanes beside guard rail on a road
- Slippery road with rain, ice, or snow covered
- Abrupt curved road
- Steep hills
- Windy roads
- Off roads
- Rods under construction
- Rumble strip
- When driving near crash barriers
- When the vehicle sensing ability decreases due to vehicle modification resulting level difference of the vehicle's front and rear
- When driving with limited view (possibly due to bad weather, such as fog, snow, rain or sandstorm)
- Pay particular attention to the driving conditions whenever using Smart Cruise Control.
- Smart Cruise Control is not a substitute for safe driving. It is the responsibility of the driver to always check the speed and distance of the vehicle ahead.
- Be careful when driving downhill using Smart Cruise Control.
- Smart Cruise Control should not be used when the vehicle is being towed to prevent any damage.
- Always set the vehicle speed under the speed limit in your country.
- Unexpected situations may lead to possible accidents. Pay attention con-

tinuously to road conditions and driving even when Smart Cruise Control is being operated.

Set Smart Cruise Control reaction

The sensitivity of vehicle speed when following the front vehicle to maintain the set distance can be adjusted. Go to the **User settings** mode (Driver Assistance) and select Smart Cruise Control reaction. You may select 1 of the 3 stages you prefer.

- **Slow:**
Vehicle speed following the front vehicle to maintain the set distance is slower than normal speed.
- **Normal:**
Vehicle speed following the front vehicle to maintain the set distance is normal
- **Fast:**
Vehicle speed following the front vehicle to maintain the set distance is faster than normal speed.

* NOTICE

The last selected mode remains in the function.

Vehicle distance setting

To set vehicle distance:

This function allows you to program the vehicle to maintain relative distance to the vehicle ahead without depressing the accelerator pedal or brake pedal.

The vehicle distance will automatically activate when Smart Cruise Control is on.

Select the appropriate distance according to road conditions and vehicle speed.

Each time the button is pressed, the vehicle distance changes as follows:

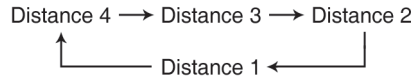

For example, if you drive at 90 km/h (56 mph), the distance maintain as follows:

- Distance 4 - approximately 52.5 m (172 ft.)
- Distance 3 - approximately 40 m (130 ft.)
- Distance 2 - approximately 32.5 m (106 ft.)
- Distance 1 - approximately 25 m (82 ft.)

* NOTICE

The distance is set to the last set distance when the function is used for the first time after starting the vehicle.

When the lane ahead is clear:



The vehicle speed will maintain the set speed.

When there is a vehicle ahead of you in your lane:

Level 4



Level 3



Level 2



Level 1



- The vehicle will maintain the set speed, when the lane ahead is clear.
- The vehicle will slow down or speed up to maintain the selected distance, when there is a vehicle ahead of you in the lane. (A vehicle will appear in front of your vehicle in the LCD display only when there is an actual vehicle in front of you)

- If the vehicle ahead speeds up, your vehicle will travel at a steady cruising speed after accelerating to the selected speed.
- If you turn on the driver's side turn signal when there is a vehicle ahead, your vehicle may temporarily accelerate to assist you in changing lanes.

Collision Warning



A: Collision warning!

If there is a high risk of collision due to sudden braking of the front vehicle or lack of safety distance with the vehicle ahead during Smart Cruise Control driving, so that if the driver's brake or steering wheel operation is required, the Distance Step with the vehicle ahead will blink on the cluster and a collision warning will sound.

In this case, immediately reduce the speed.

⚠ CAUTION

- Even if the warning message does not appear and warning chime does not sound, always pay attention to driving conditions to prevent dangerous situations from occurring.
- Playing the vehicle audio system at high volume may cause the occupants to not hear the function warning sounds.
- If the vehicle cannot keep the enough set distance, the warning will sound and blink on the cluster. If a warning sounds, check the nearby traffic con-

dition and if necessary, control the speed by depressing the brake pedal. Always pay attention in case of danger, even if there is no warning sound.

WARNING

- If the speed of the vehicle ahead is similar to or faster than your vehicle, the function may not warn you as you do not maintain enough set distance. Always pay attention in case of danger, even if there is no warning sound.
- If the speed of the vehicle ahead is too slow, the function may not warn you as you do not maintain enough set distance. Always pay attention in case of danger, even if there is no warning sound.
- If you set Smart Cruise Control speed and depress the accelerator pedal, the function may not warn you as you do not maintain enough set distance. Always pay attention in case of danger, even if there is no warning sound.

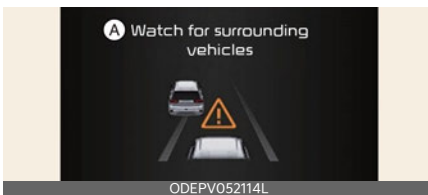

A: Watch for surrounding vehicles

CAUTION

If the vehicle ahead (vehicle speed: less than 30 km/h (20 mph)) disappears to the next lane, the warning chime will sound and a message will appear. Adjust your vehicle speed for vehicles or objects that can suddenly appear in front of you by depressing the brake pedal according to the road condition ahead and driving condition.

In traffic situation



A: Use switch or pedal to accelerate

- In traffic, your vehicle will stop if the vehicle ahead of you stops. Also, if the vehicle ahead of you starts moving, your vehicle will start as well. However, if the vehicle stops for more than 3 seconds, you must depress the accelerator pedal or push up the switch (RES+/SET-) to start driving.
- If you push Smart Cruise Control switch (RES+ or SET-) while AUTO HOLD and Smart Cruise Control is operating the AUTO HOLD will be released regardless of accelerator pedal operation and the vehicle will start to move. The AUTO HOLD indicator changes from green to white.

To convert to Cruise Control mode:

The driver may choose to only use Cruise Control mode (speed control function) by doing as follows:

1. Turn Smart Cruise Control on (CRUISE indicator light will be on but the function will not be activated).

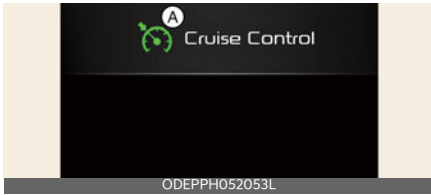

A: Cruise Control

2. Push the distance to distance switch for more than 2 seconds.
3. Choose between **Smart Cruise Control mode** and **Cruise Control mode**.

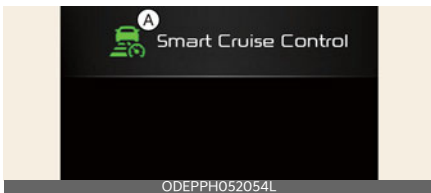

A: Smart Cruise Control

When the function is canceled using the Driving Assist button or the Driving Assist button is used after the vehicle is turned on, the Smart Cruise Control mode will turn on.

⚠ WARNING

When using Cruise Control mode, you must manually access the distance to other vehicles as the function will not automatically brake to slow down for other vehicles.

Detecting sensor

Front view camera



Front view camera is a sensor for detecting lanes and the vehicles in front.

If the sensor is covered with dirt, snow or other foreign matter, the sensor's detection performance will be degraded and Smart Cruise Control will be temporarily canceled so that it does not properly work until it is cleaned.

Always keep the area in front of the sensor clean.

For more information of front view camera, refer to "Lane Keeping Assist (LKA) (if equipped)" on page 6-45.

Front radar



Front radar detects the distance to the vehicle ahead.

If the sensor or sensor cover is covered with dirt, snow or other foreign matter, the sensor's detection performance will be degraded and Smart Cruise Control will be temporarily canceled so that it does not properly work until it is cleaned.

Always keep the area in front of the sensor clean.

Warning message

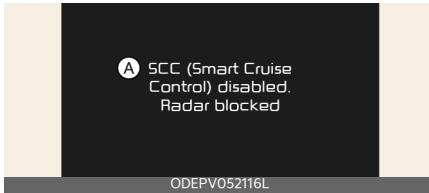

A: SCC (Smart Cruise Control) disabled. Radar blocked

When the sensor cover is blocked with dirt, snow, or debris, Smart Cruise Control operation may stop temporarily. If this occurs, a warning message will appear on the LCD display. Remove any dirt, snow, or debris and clean the radar sensor cover before operating Smart Cruise Control. Smart Cruise Control may not properly activate, if the radar is totally contaminated, or if any substance is not detected after turning ON the motor (e.g. in an open terrain).

Smart Cruise Control malfunction message

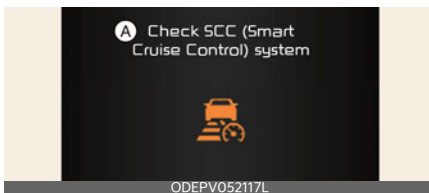

A: Check SCC (Smart Cruise Control) system

The message will appear when the vehicle distance control is not functioning normally.

In this case, have the system checked by a professional workshop. Kia recommends to visit an authorized Kia dealer/service partner.

CAUTION

- Do not install accessories around the sensor and do not replace the bumper by yourself. It may interfere with the sensor performance.
- Always keep the sensor and bumper clean.
- To prevent sensor cover damage from occurring, wash the car with a soft cloth.
- Do not damage the sensor or sensor area by a strong impact. If the sensor moves slightly off position, Smart Cruise Control will not operate correctly without any warning or indicator from the cluster. If this occurs, have the function checked by a professional workshop. Kia recommends to visit an authorized Kia dealer/service partner.
- Use only a genuine Kia sensor cover for your vehicle. Do not paint anything on the sensor cover.
- If the front bumper becomes damaged in the area around the radar sensor, Smart Cruise Control may not operate properly.
- Do not tint the window or install stickers, accessories around the inside mirror where the camera is installed.
- Make sure the frontal camera installation point does not get wet.
- Do not place reflective objects (white paper or mirror etc.) on the crash pad. Forward Collision-Avoidance Assist may activate unnecessarily due to reflect of the sunlight.
- Do not impact or arbitrarily remove any front view camera components.

Limitations of Smart Cruise Control

Smart Cruise Control may have limits to its ability to detect distance to the vehicle ahead due to road and traffic conditions.

Driving on a curved road

- On curves, Smart Cruise Control may not detect a moving vehicle in your lane, and then your vehicle could accelerate to the set speed. Also, the vehicle speed will rapidly slow down when the vehicle ahead is recognized suddenly.



- Select the appropriate set speed on curves and adjust your vehicle speed by depressing the accelerator or brake pedal according to the road condition ahead and driving condition.
- Your vehicle speed can be reduced due to a vehicle in the adjacent lane. Adjust your vehicle speed by depressing the brake pedal according to the road condition ahead and driving condition. Apply the accelerator pedal and select the appropriate set speed. Check to be sure that the road conditions permit safe operation of Smart Cruise Control.



Driving on an inclined road

- During uphill or downhill driving, Smart Cruise Control may not detect a moving vehicle in your lane, and cause your vehicle to accelerate to the set speed. Also, the vehicle speed will rapidly slow down when the vehicle ahead is recognized suddenly.



- Select the appropriate set speed on inclines and adjust your vehicle speed by depressing the accelerator or brake pedal according to the road condition ahead and driving condition.

Changing lanes

- A vehicle which moves into your lane from an adjacent lane cannot be recognized by the sensor until it is in the sensor's detection range.

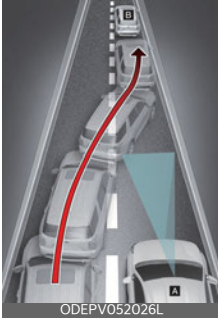

[A]: Your vehicle, [B]: Lane changing vehicle

- The sensor may not detect immediately when a vehicle cuts in suddenly. Always pay attention to the traffic, road and driving conditions.
- If a vehicle which moves into your lane is slower than your vehicle, your speed may decrease to maintain the distance to the vehicle ahead.
- If a vehicle which moves into your lane is faster than your vehicle, your vehicle will accelerate to the selected speed.
- Your vehicle may accelerate when a vehicle ahead of you disappears.
- When you are warned that the vehicle ahead of you is not detected, drive with caution.



Recognizing the vehicle

Some vehicles ahead in your lane cannot be recognized by the sensor as follows:

- Narrow vehicles such as motorcycles or bicycles
- Vehicles offset to one side
- Slow-moving vehicles or sudden decelerating vehicles
- Stopped vehicles
- Vehicles with small rear profile such as trailers with no loads

A vehicle ahead cannot be recognized correctly by the sensor if any of following occurs:

- When the vehicle is pointing upwards due to overloading in the tailgate
- While making turns by steering
- When driving to one side of the lane
- When driving on narrow lanes or on curves

Adjust your vehicle speed by depressing the brake pedal according to the road condition ahead and driving condition.

- When vehicles are at a standstill and the vehicle in front of you changes to the next lane, be careful when your vehicle starts to move because it may not recognize the stopped vehicle in front of you.

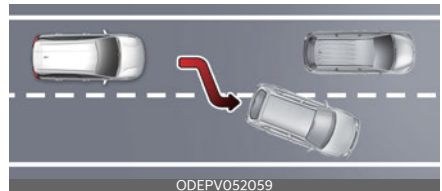

In this case, you must maintain a safe braking distance, and if necessary, depress the brake pedal to reduce your driving speed in order to maintain a safe distance.

- Always look out for pedestrians when your vehicle is maintaining a distance with the vehicle ahead.

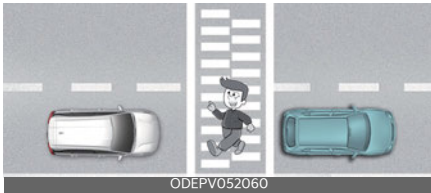

- Always be cautious for vehicles with higher height or vehicles carrying loads that sticks out to the back of the vehicle.

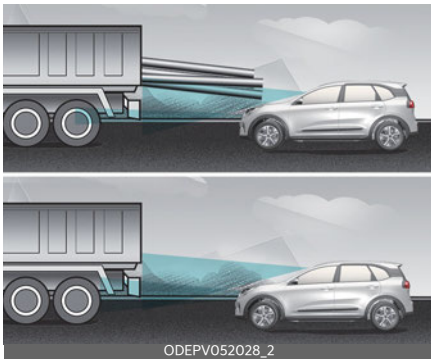

⚠ WARNING

- Smart Cruise Control cannot guarantee the stop for every emergency situation.
If an emergency stop is necessary, you must apply the brakes.
- Keep a safe distance according to road conditions and vehicle speed. If the vehicle distance is too close during a high-speed driving, a serious collision may result.
- Smart Cruise Control cannot recognize a stopped vehicle, pedestrians or an oncoming vehicle. Always look ahead cautiously to prevent unex-

pected and sudden situations from occurring.

- Smart Cruise Control may have difficulty in maintaining the correct distance or speed, if the vehicle is driving on a steep incline or towing a trailer.
- When other vehicles are changing lanes in front of you frequently, Smart Cruise Control may not operate appropriately. Always look ahead cautiously to prevent unexpected and sudden situations from occurring.
- Smart Cruise Control is not a substitute for safe driving practices but a convenience function only. It is the responsibility of the driver to always check the speed and the distance to the vehicle ahead.
- Always be aware of the selected speed and vehicle distance.
- Always maintain sufficient braking distance and decelerate your vehicle by applying the brakes if necessary.
- As Smart Cruise Control may not recognize complex driving situations, always pay attention to driving conditions and control your vehicle speed.
- For safe operation, carefully read and follow the instructions in this manual before use.
- While other warning sound is played such as not fastening the seat belt, Smart Cruise Control warning sound may not occur.
- When driving with Smart Cruise Control set speed it may be possible that a vehicle which is parked ahead is not detected. Be careful if you fully rely on Smart Cruise Control in such case, you may encounter a risk of collision.
- Please turn off Smart Cruise Control while towing.

- If the vehicle ahead disappears while driving and maintaining the set distance, the vehicle may accelerate until it reaches to set speed. Be careful for a possible dangerous situation.
- When driving on a slippery road, be careful for possible dangerous situations.
- Beware of dangerous situations as you may quickly pass vehicles driving in the next lane.

⚠ CAUTION

Smart Cruise Control may not operate temporarily due to electrical interference.

Lane Following Assist (LFA) (if equipped)



Lane Following Assist is designed to center the vehicle in the chosen lane by using a front view camera on top of the windshield.

* LFA stands for Lane Following Assist.

Lane Following Assist settings

Activating Lane Following Assist



With the vehicle ON, press the Lane Driving Assist button located on the steering wheel to turn on Lane Following Assist. The white or green indicator light (🚗) will appear on the cluster.

Press the Lane Driving Assist button again to turn off the function.

Select or release the setting from **User settings** → **Driver assistance** → **Lane Following Assist** on the LCD display. Once the function starts working, the indicator light (🚗) will appear on the cluster.

- Green: steering assist mode on
- White: steering assist mode off

⚠ WARNING

- It is the driver's responsibility to operate the steering wheel for safe driving.
- Do not turn the steering wheel hastily if Lane Following Assist is in work.
- Lane Following Assist assists the steering wheel control over the direction so that the vehicle can stay in the center of the lane. Lane Following Assist does not automatically control the steering wheel of at all times, which means the driver must not hands off the wheel while driving.
- When using Lane Following Assist, always be aware of your surroundings and road conditions that may interrupt or stop Lane Following Assist.

⚠ CAUTION

- Do not attach glass tinting, stickers, accessories to the windshield where the front view camera near the indoor mirror is placed.
- The removal or re-assembly of the front view camera to attach tinting, stickers, accessories may require Lane Following Assist to be thoroughly inspected and modified. In such case, Kia recommend that you have your vehicle inspected by an authorized Kia dealer/service partner.
- Inspection or modification may be required when replacing parts related to the windshield or front view camera, steering. have the system checked by a professional workshop. Kia recommends to visit an authorized Kia dealer/service partner.
- Depending on your surroundings and road conditions, Lane Following Assist could fail to recognize the lane and stop working. In turn, extra caution is

required while driving with Lane Following Assist on.

- Be sure to check the non-operating conditions and cautions for the driver before using Lane Following Assist.
- Do not place reflective materials such as white paper or mirror on the crash pad. Sunlight reflections can cause a malfunction in Lane Following Assist.
- Too big sound from the sound system can interrupt the alarming sound from Lane Following Assist.
- Keeping your hands off the wheel while driving will trigger the hands-off warning and deactivate the steering-assist. Put your hands back on the wheel, then the steering-assist will be re-activated.
- When driving at a high speed, the steering assist force can become weak and the vehicle can drive out of its lane. Extra caution is required, and comply with the speed limit.
- Attaching an object to the steering wheel could deter steering assistance.
- Attaching an object to the steering wheel could deter the hands-off alarming system.

Steering assist

If the vehicle is inside the lane with both lanes recognized by the function, and there is no steep steering made by the driver, Lane Following Assist changes into steering assist mode. The indicator light will come on green, and the function helps the vehicle stay in line by controlling the steering wheel.

When the steering wheel is not controlled temporarily, the indicator light will flash green and changes to white.

When the both lanes are not recognized by the function, the function controls the steering wheel limitedly whether there is a vehicle in front or not.

⚠️ WARNING

Lane Following Assist ensures the vehicle stays in its lane. Lane Following Assist does not guarantee 100% safety. Make sure you make decisions on the road after checking the road conditions and safety matters while driving. Never completely rely on your Lane Following Assist.

Hands-off warning

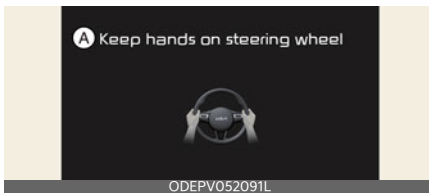

A: Keep hands on steering wheel

- If you keep your hands off the wheel while driving with Lane Following Assist assisting the steering, the hands-off warning will be triggered.
- If the driver still does not have their hands on the steering wheel after the hands-off warning, the **Lane Following Assist (LFA) canceled** warning message will appear and Lane Following Assist will be automatically canceled.

If the driver keeps hands off the wheel even with the hands-off warning on, the steering assist is temporarily released automatically.

If you put your hands back on the wheel with Lane Following Assist released, the steering assist will restart.

⚠️ CAUTION

- Hands-off warnings may be delayed depending on road conditions. Always keep your hands on the steering wheel while driving.
- Hold the steering wheel tight. Otherwise, Lane Following Assist could misjudge that the driver hands off the wheel, and a hands-off warning may occur.

Lane Following Assist malfunction and limitations

Lane Following Assist malfunction

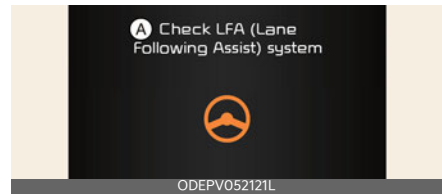

A: Check LFA (Lane Following Assist) system

The warning message popped up (turned off after a certain period of time) means a problem with Lane Following Assist. In this case, have the system checked by a professional workshop. Kia recommends to visit an authorized Kia dealer/service partner.

⚠️ CAUTION

- It is the driver's responsibility to operate the steering wheel while driving.
- With Lane Following Assist on, the driver can steer the vehicle by operating the wheel on his own.

- We recommend that the driver turns off Lane Following Assist and operates the steering wheel by himself in the following cases
 - Bad weather
 - Bad road conditions
 - When frequent operation of the steering wheel is required
 - When towing other vehicle or trailers
- The steering wheel can feel heavy or light if Lane Following Assist is assisting the steering.
- When sudden steering is made, the function could be temporarily deactivated.
- If you change the lane in a hurry, the function does not assist the steering.
- If the vehicle suddenly stops, it does not assist the steering.
- If the lane is too narrow or too wide, steering is not assisted.
- If the function is not able to recognize a vehicle in front and either of the lanes is not recognized, the steering is not assisted
- If the radius is too small for the curve

Limitations of Lane Following Assist

- If the driver turns on the turn signal light or the emergency warning light to change the lane
 - Operate the turn signal light switch before changing the lane
 - If you change the lane without operating the turn signal lights, steering reaction force of the wheel may occur.
- Once Lane Following Assist is turned on or the lane is changed, the vehicle should be in the center of the road to switch to the steering assist mode. If the driver keeps driving along the lane, Lane Following Assist will not assist the steering.
- When the ESC or VSM is activated, the function does not assist steering.
- When driving on a curved road at a high speed, steering assist mode may not work.
- When driving at a speed faster than 150 km/h (90 mph), steering assist mode may not work.

Cautions for the driver

If the lane recognition is difficult or limited for Lane Following Assist as shown below, the driver may need to be careful because it may not operate or may cause unnecessary operation.

Roads or lane markings in bad condition

- When The lane is tainted or invisible
- When the driver cannot see the lane due to rain, snow, dust, sand, oil, puddles, etc
- When roads are set or the colors of the lane and road are not distinctive
- If there is a sign other than the lane near the lane or a mark similar to the lane
- When the lane is not clear or damaged
- If the road is covered in the shadows of objects around the road, such as medians, guard rails, noise walls, and trees

- If the number of lanes increases or decreases, or if the lanes intersect with each other more intensely (toll-gate entry section, road section/joining section, etc.)
- When there are two or more lane markings such as a construction section, a designated lane, etc.
- When the lane is crowded such as the construction section or the lane is replaced by some structures
- If there is a road marking such as a zigzag lane, crosswalk mark, or road surface milestone
- When a lane suddenly becomes invisible or disappears from an intersection

The external environment affecting the function

- If the outside brightness of the vehicle suddenly changes, such as when entering or exiting the tunnel or passing under the bridge
- If the vehicle's headlights are not used at night or in the tunnel, or the brightness of the headlights is too weak
- If there are boundary structures such as tollgate booths and sidewalk blocks
- If it is difficult to distinguish lanes due to the reflection on the wet road made by sunlight, streetlight, and oncoming traffic.
- When the backlight is strongly reflected in the direction of the vehicle
- When Driving to the left or right lane by bus lane or on the bus lane
- If there is no enough distance between the front car or if the lane is covered by the car ahead of me
- When the lane change is large, such as a steep curve or a continuous curve
- When passing through speed bump, sudden up/down or left/right slope
- If the vehicle is severely shaken
- When the temperature around the mirror is very high due to direct sunlight

When the front view camera has poor visibility

- If the windshield of the vehicle and the camera lens are covered with dust, fingerprints, or tinting.
- If the camera has poor visibility due to bad weather such as fog, heavy rain, heavy snow.
- If moisture is not completely removed from the windshield.
- When placing objects on the dashboard, etc.

Rear View Monitor (RVM)



Rear View Monitor will activate when the vehicle is on and the shift to R (Reverse) position.

This is a supplemental function that shows the area behind the vehicle through the audio or multi media screen display while backing-up.

⚠ WARNING

Rear View Monitor is not a safety device. It only serves to assist the driver in identifying objects directly behind the middle of the vehicle. The camera does NOT cover the complete area behind the vehicle.

⚠ WARNING

- Never rely solely on the rear camera display when backing up.
- Always look around your vehicle to make sure there are no objects or obstacles before moving the vehicle in any direction to prevent a collision.

⚠ CAUTION

If the camera lens is covered with foreign material, Rear View Monitor may not operate normally. Always keep the camera lens clean. However, do not use chemical solvents such as strong detergents containing high alkaline or volatile organic solvents (gasoline, acetone etc.). This may damage the camera lens.

⚠ CAUTION

- Do not spray the camera or its surrounding area directly with a high pressure washer. Shock applied from high pressure water may cause the device to not operate normally.
- Do not use any cleanser containing acid or alkaline detergents when cleaning the lens. Use only a mild soap or neutral detergent, and rinse thoroughly with water.

* NOTICE

Always keep the camera lens clean. The camera may not work normally if the lens is covered with dirt, water or snow.

Rear Cross-Traffic Collision Warning (RCCW) (if equipped)

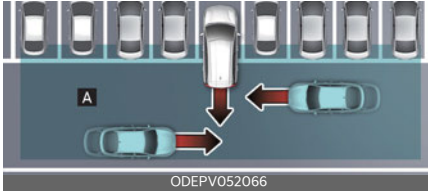

[A]: Rear Cross-Traffic Collision Warning operating range

Rear Cross-Traffic Collision Warning uses rear corner radar sensors to monitor for the approaching cross traffic from the left and right side of the vehicle when your vehicle is in reverse.

The blind spot detection range varies relative to the approaching vehicle speed.

WARNING

- Always be aware of road conditions while driving and be alert for unexpected situations even though Rear Cross-Traffic Collision Warning is operating.
- Rear Cross-Traffic Collision Warning is supplemental functions to assist you. Do not entirely rely on the functions. Always pay attention, while driving, for your safety.
- Rear Cross-Traffic Collision Warning is not substitutes for proper and safe driving. Always drive safely and use caution when backing up the vehicle.

Setting and activating Rear Cross-Traffic Collision Warning

Settings

- The driver can activate the function by placing the vehicle to the ON position and by selecting **User settings** → **Driver assistance** → **Rear Cross-Traffic Collision Warning**. Rear Cross-Traffic Collision Warning will turn on and get activated.
- When the vehicle is turned off then on again, the functions always get ready to be activated.
- When the function is initially turned on and when the vehicle is turned off then on again, the warning light will appear for 3 seconds on the outside rear view mirror.

Operating conditions

The function will activate when vehicle speed is below 10 km/h and with the shift lever in R (Reverse).

- The function will not activate when the vehicle speed exceeds 10 km/h (6 mph). The function will activate again when the speed is below 8 km/h (5 mph).

The function's detecting range is approximately 0.5~20 m (1.6~60 ft.). An approaching vehicle will be detected if their vehicle speed is within 8~36 km/h (5~20 mph).

Note that the detecting range may vary under certain conditions. As always, use caution and pay close attention to your surroundings when backing up your vehicle.

Warning message and function control

Rear Cross-Traffic Collision Warning



If the vehicle detected by the sensors approaches from the rear left/right side of your vehicle, the warning chime will sound, the warning light on the outside rear view mirror will blink and a message will appear on the LCD display.

The warning will stop when:

- The vehicle moving at the rear left/right side of your vehicle is not in the detection range.
- The vehicle is right behind your vehicle.
- The vehicle is not driving towards your vehicle.
- The vehicle's approaching speed is decreased.

⚠ CAUTION

- When the operation condition of Rear Cross-Traffic Collision Warning is met, the warning will occur every time a vehicle approaches the side or rear of your stopped (0 km/h (0 mph) vehicle speed) vehicle.
- The function's warning or brake may not operate properly if the left or right of your vehicle's rear bumper is blocked by a vehicle or obstacle.
- The driver should always use extreme caution while operating the vehicle, whether or not the warning light on the outer side view mirror appears or there is a warning alarm.
- Playing the vehicle audio system at high volume may prevent occupants from hearing the function's warning sounds.
- If any other warning sound such as seat belt warning chime is already generated, the Rear Cross-Traffic Collision Warning may not sound.

⚠ WARNING

- Drive safely even though the vehicle is equipped with Rear Cross-Traffic Collision Warning. Do not solely rely on the function but check your surrounding when backing the vehicle up.
- The driver is responsible for accurate brake control.
- Always pay extreme caution while driving. Rear Cross Traffic Collision Warning may not operate properly or unnecessarily operate depending on traffic and driving conditions.

Detecting sensor

Rear corner radar



The rear corner radars are located inside the rear bumper for detecting the side and rear areas.

Always keep the rear bumper clean for proper operation of the function.

CAUTION

- The function may not work properly when the bumper has been damaged, or if the rear bumper has been replaced or repaired.
- The function may turn off due to strong electromagnetic waves.
- Always keep the sensors clean.
- Never arbitrarily disassemble the sensor component nor apply any impact on the sensor component.
- Be careful not to apply unnecessary force on the radar sensor or sensor cover. If the sensor is forcibly moved out of proper alignment, the function may not operate correctly. In this case, a warning message may not be displayed.

Take your vehicle to a professional workshop and have the function checked. Kia recommends to visit an authorized Kia dealer/service partner.

- Do not apply foreign objects such as a bumper sticker or a bumper guard near the radar sensor or apply paint to the sensor area. Doing so may

adversely affect the performance of the sensor.

Turning off Rear Cross-Traffic Collision Warning when a trailer or carrier is installed

- Press the Blind-Spot Safety button (the indicator on the button extinguish)
- If you use Rear Cross-Traffic Collision Warning, remove a trailer or carrier.

When Rear Cross-Traffic Collision Warning canceled warning message is displayed in the cluster, check to make sure that the rear bumper is free from any dirt or snow in the areas where the sensor is located. Remove any dirt, snow, or foreign material that could interfere with the radar sensors.

After any dirt or debris is removed, Rear Cross-Traffic Collision Warning should operate normally after about 10 minutes of driving the vehicle.

If the function still does not operate normally, Kia recommend that you have your vehicle inspected by an authorized Kia dealer/service partner.

Rear Cross-Traffic Collision Warning malfunction and limitations

Rear Cross-Traffic Collision Warning disabled

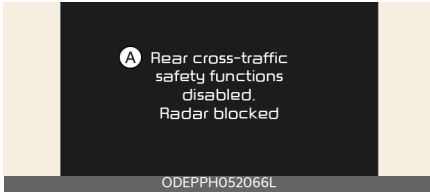

A: Rear cross-traffic safety functions disabled. Radar blocked

This warning message may appear when:

- One or both of the sensors on the rear bumper is blocked by dirt or snow or a foreign object.
- Driving in rural areas where the sensor does not detect another vehicle for an extended period of time.
- When there is inclement weather such as heavy snow or rain.
- A trailer or carrier is installed. (To use Rear Cross-Traffic Collision Warning, remove the trailer or carrier from your vehicle.)

If any of these conditions occur, the light on the Blind-Safety button and the function will turn off automatically.

When **Rear Cross-Traffic Collision Warning canceled** warning message is displayed in the cluster, check to make sure that the rear bumper is free from any dirt or snow in the areas where the sensor is located. Remove any dirt, snow, or foreign material that could interfere with the radar sensors.

After any dirt or debris is removed, Rear Cross-Traffic Collision Warning should operate normally after about 10 minutes

of driving the vehicle. If the function does not work normally even though the foreign substance, trailer or carrier, or other equipment is removed, take your vehicle to a professional workshop and have the function checked. Kia recommends to visit an authorized Kia dealer/service partner.

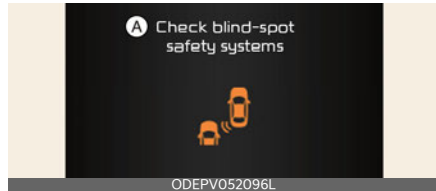

A: Check blind-spot safety systems

If there is a problem with Rear Cross-Traffic Collision Warning, a warning message will appear and the light on the switch will turn off. The function will turn off automatically.

In this case, have the function checked by a professional workshop. Kia recommends to visit an authorized Kia dealer/service partner.

Non-operating conditions

Outside rear view mirror may not alert the driver when:

- The outside rear view mirror housing is damaged or covered with debris.
- The window is covered with debris.
- The windows are severely tinted.
- The mirror is covered with dirt, snow, or debris.

Limitations of Rear Cross-Traffic Collision Warning

The driver must be cautious in the below situations, because the function may not detect other vehicles or objects in certain circumstances.

- When a trailer or carrier is installed.

- The vehicle drives in inclement weather such as heavy rain or snow.
- The sensor is polluted with rain, snow, mud, etc.
- The rear bumper where the sensor is located is covered with a foreign object such as a bumper sticker, a bumper guard, a bike rack, etc.
- The rear bumper is damaged, or the sensor is out of the original default position.
- The vehicle height gets lower or higher due to heavy loading in a tail-gate, abnormal tire pressure, etc.
- When the temperature of the rear bumper is high.
- When the sensors are blocked by other vehicles, walls or parking-lot pillars.
- The vehicle drives on a curved road.
- The road pavement (or the peripheral ground) abnormally contains metallic components (i.e. possibly due to sub-way construction).
- There is a fixed object near the vehicle, such as a guardrail.
- While going down or up a steep road where the height of the lane is different.
- Driving on a narrow road where trees or grass or overgrown.
- Driving in rural areas where the sensor does not detect another vehicle for an extended period of time.
- Driving on a wet road.
- Driving on a road where the guardrail or wall is in double structure.
- A big vehicle is near such as a bus or truck.
- When the other vehicle approaches very close.

- When the other vehicle passes at a very fast speed.
- While changing lanes.
- If the vehicle has started at the same time as the vehicle next to you and has accelerated.
- When the vehicle in the next lane moves two lanes away from you OR when the vehicle two lanes away moves to the next lane from you.
- A motorcycle or bicycle is near.
- A flat trailer is near.
- If there are small objects in the detecting area such as a shopping cart or a baby stroller.
- If there is a low height vehicle such as a sports car.
- The brake pedal is depressed.
- ESC (Electronic Stability Control) is activated.
- ESC (Electronic Stability Control) malfunctions.
- The tire pressure is low or a tire is damaged.
- The brake is reworked.
- The vehicle sharply stops.
- Temperature is extremely low around the vehicle.
- The vehicle severely vibrates while driving over a bumpy road, uneven/bumpy road, or concrete patch.
- The vehicle drives on a slippery surface due to snow, water puddle, or ice.

- Driving where there is a vehicle or structure near.



[A]: Structure

The function may not operate properly when driving where there is a vehicle or structure near.

In certain instances, the function may not detect the vehicle approaching from behind and the warning or brake may not operate properly.

Always pay attention to your surrounding while driving.

- When the vehicle is in a complex parking environment.



The function may not operate properly when the vehicle is in a complex parking environment.

In certain instances, the function may not be able to exactly determine the risk of collision for the vehicles which are parking or pulling out near your vehicle (e.g. a vehicle escaping beside your vehicle, a vehicle parking or pulling out in the rear area, a vehicle approaching your vehicle making a turn, etc.).

In this case, the warning or brake may not operate properly.

- When the vehicle is parked diagonally

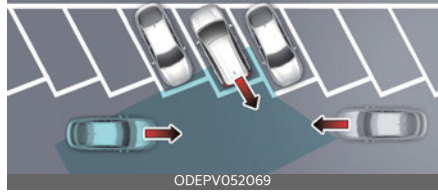

[A]: Vehicle

The function may not operate properly when the vehicle is parked diagonally.

In certain instances, when the diagonally parked vehicle is pulled out of the parking space, the function may not detect the vehicle approaching from the rear left/right of your vehicle. In this case, the warning or brake may not operate properly.

Always pay attention to your surrounding while driving.

- When the vehicle is on/near a slope



The function may not operate properly when the vehicle is on/near a slope.

In certain instances, the function may not detect the vehicle approaching from the rear left/right and the warning or brake may not operate properly.

Always pay attention to your surrounding while driving.

- Pulling into the parking space where there is a structure

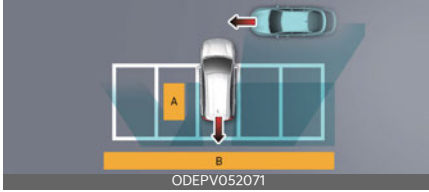

[A]: Structure, [B]: Wall

The function may not operate properly when pulling in the vehicle to the parking space where there is a structure at the back or side of your vehicle.

In certain instances, when backing into the parking space, the function may not detect the vehicle moving in front of your vehicle. In this case, the warning or brake may not operate properly.

Always pay attention to the parking space while driving.

- When the vehicle is parked rearward

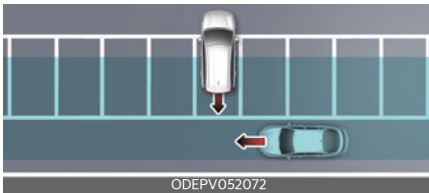

If the vehicle is parked rearward and the sensor detects the another vehicle in the rear area of the parking space, the function can warn or control braking. Always pay attention to the parking space while driving.

Reverse Parking Distance Warning (PDW) (if equipped)



Reverse Parking Distance Warning assists the driver during backward movement of the vehicle by chiming if any object is sensed within a distance of 120 cm (48 inches) behind the vehicle.

This function is a supplemental function and it is not intended to nor does it replace the need for extreme care and attention of the driver. The sensing range and objects detectable by rear ultrasonic sensors are limited. Whenever backing-up, pay as much attention to what is behind you as you would in a vehicle without a Reverse Parking Distance Warning.

⚠ WARNING



Reverse Parking Distance Warning is a supplementary function only. The operation of Reverse Parking Distance Warning can be affected by several factors (including environmental conditions). It is the responsibility of the driver to always check the area behind the vehicle before and while backing up.

Operation of Reverse Parking Distance Warning

Operating condition

- This function will activate when backing up with the vehicle is ON position. If the vehicle is moving at a speed over 5 km/h (3 mph), the function may not be activated correctly.
- The sensing distance while Reverse Parking Distance Warning is in operation is approximately 120 cm (48 inches).
- When more than two objects are sensed at the same time, the closest one will be recognized first.

*: if equipped

Types of warning sound	Indicator*
When an object is 60~120 cm (24~48 inches) from the rear bumper: Buzzer beeps intermittently.	
When an object is 30~60 cm (12~24 inches) from the rear bumper: Buzzer beeps more frequently	
When an object is within 30 cm (12 inches) of the rear bumper: Buzzer sounds continuously	

* NOTICE

The indicator may differ from the illustration as objects or sensors status. If the indicator blinks, have the function checked by a professional workshop. Kia recommends to visit an authorized Kia dealer/service partner.

Non-operational conditions of Reverse Parking Distance Warning

Reverse Parking Distance Warning may not operate properly when:

1. Moisture is frozen to the sensor. (It will operate normally when the moisture has been cleared.)
2. The sensor is covered with foreign matter, such as snow or water, or the sensor cover is blocked. (It will operate normally when the material is removed or the sensor is no longer blocked.)
3. Driving on uneven road surfaces (unpaved roads, gravel, bumps, gradient).
4. Objects generating excessive noise (vehicle horns, loud motorcycle engines, or truck air brakes) are within range of the sensor.
5. Heavy rain or water spray exists.
6. Wireless transmitters or mobile phones are within range of the sensor.
7. The sensor is covered with snow.
8. Trailer towing

The detecting range may decrease when:

1. The sensor is stained with foreign matter such as snow or water. (The sensing range will return to normal when removed.)
2. Outside air temperature is extremely hot or cold.

The following objects may not be recognized by the sensor:

1. Sharp or slim objects such as ropes, chains or small poles.
2. Objects which tend to absorb the sensor frequency such as clothes, spongy material or snow.
3. Undetectable objects smaller than 100 cm (40 inches) in height and narrower than 14 cm (6 inches) in diameter.

Reverse Parking Distance Warning

- Reverse Parking Distance Warning may not sound consistently depending on the speed and shapes of the objects detected.
- Reverse Parking Distance Warning may malfunction if the vehicle bumper height or sensor installation has been modified or damaged. Any non-factory installed equipment or accessories may also interfere with the sensor performance.
- The sensor may not recognize objects less than 30 cm (12 inches) from the sensor, or it may sense an incorrect distance. Use caution.
- When the sensor is frozen or stained with snow, dirt, or water, the sensor may be inoperative until the stains are removed using a soft cloth.
- Do not push, scratch or strike the sensor. Sensor damage could occur.

* NOTICE

This function can only sense objects within the range and location of the sensors; It can not detect objects in other areas where sensors are not installed. Also, small or slim objects, such as poles

or objects located between sensors may not be detected by the sensors.

Always visually check behind the vehicle when backing up.

Be sure to inform any drivers of the vehicle that may be unfamiliar with the function regarding the functions capabilities and limitations.

⚠ WARNING

Pay close attention when the vehicle is driven close to objects on the road, particularly pedestrians, and especially children. Be aware that some objects may not be detected by the sensors, due to the object's distance, size or material, all of which can limit the effectiveness of the sensor. Always perform a visual inspection to make sure the vehicle is clear of all obstructions before moving the vehicle in any direction.

Self-diagnosis

If you don't hear an audible warning sound or if the buzzer sounds intermittently when shifting the gear to the R (Reverse) position, this may indicate a malfunction in Reverse Parking Distance Warning. If this occurs, have the function checked by a professional workshop. Kia recommends to visit an authorized Kia dealer/service partner.

⚠ WARNING

Your new vehicle warranty does not cover any accidents or damage to the vehicle or injuries to its occupants due to a Reverse Parking Distance Warning malfunction. Always drive safely and cautiously.

Forward/Reverse Parking Distance Warning (PDW) (if equipped)

Front ultrasonic sensors



Rear ultrasonic sensors



Forward/Reverse Parking Distance Warning assists the driver during movement of the vehicle by chiming if any object is sensed within the distance of 100 cm (40 inches) in front and 120 cm (48 inches) behind the vehicle.

This function is a supplemental function and it is not intended to nor does it replace the need for extreme care and attention of the driver.

The sensing range and objects detectable by the sensors are limited. Whenever moving pay as much attention to what is in front and behind of you as you would in a vehicle without a Forward/Reverse Parking Distance Warning.

⚠ WARNING

Forward/Reverse Parking Distance Warning should only be considered as a supplementary function. The driver must check the front and rear view. The operational function of Forward/Reverse Parking Distance Warning can be affected by many factors and conditions of the surroundings, so the responsibility rests always with the driver.

Operation of Forward/Reverse Parking Distance Warning

Operating condition

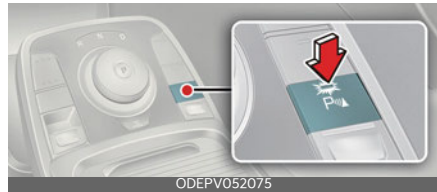

- This function activates when the Parking Safety button is pressed with the vehicle is ON position.
- The indicator of the Parking Safety button turns on automatically and activates Forward/Reverse Parking Distance Warning when you shift the gear to the R (Reverse) position.
- The sensing distance while backing up is approximately 120 cm (48 inches) when you are driving less than 10 km/h (6 mph).
- The sensing distance while moving forward is approximately 100 cm (40 inches) when you are driving less than 10 km/h (6 mph).
- When more than two objects are sensed at the same time, the closest one will be recognized first.

- The side sensors are activated when you shift the gear to the R (Reverse) position.
- If the vehicle speed is above 20 km/h (12 mph), the function automatically turns off. To activate again, push the button.

*** NOTICE**

It may not operate if it's distance from the object is already less than approximately 25 cm (10 inches) when the function is ON.

Type of warning indicator and sound

Distance from object		Warning indicator		Warning sound
		When driving forward	When driving rearward	
60-100 cm (24-40 inches)	Front		-	Buzzer beeps intermittently
	Rear	-		Buzzer beeps intermittently
30-60 cm (12-24 inches)	Front			Buzzer beeps frequently
	Rear	-	-	Buzzer beeps frequently
Within 30 cm (12 inches)	Front			Buzzer sounds continuously
	Rear	-	-	Buzzer sounds continuously

*** NOTICE**

- The actual warning sound and indicator may differ from the illustration according to objects or sensor status.
- Do not wash the vehicle's sensor with high pressure water.

⚠ CAUTION

- This function can only sense objects within the range and location of the sensors;
It can not detect objects in other areas where sensors are not installed. Also, small or slim objects, such as poles or objects located between sensors may not be detected by the sensors.
Always visually check behind the vehicle when backing up.
- Be sure to inform any drivers of the vehicle that may be unfamiliar with the function regarding the functions capabilities and limitations.

Non-operational conditions of Forward/Reverse Parking Distance Warning

Forward/Reverse Parking Distance Warning may not operate normally when:

1. Moisture is frozen to the sensor. (It will operate normally when moisture melts.)
2. Sensor is covered with foreign matter, such as snow or water, or the sensor cover is blocked. (It will operate normally when the material is removed or the sensor is no longer blocked.)
3. Sensor is stained with foreign matter such as snow or water. (Sensing range will return to normal when removed.)
4. The Parking Safety button is off.

There is a possibility of Forward/Reverse Parking Distance Warning malfunction when:

1. Driving on uneven road surfaces such as unpaved roads, gravel, bumps, or gradient.
2. Objects generating excessive noise such as vehicle horns, loud motorcycle engines, or truck air brakes can interfere with the sensor.
3. Heavy rain or water spray.
4. Wireless transmitters or mobile phones present near the sensor.
5. Sensor is covered with snow.

Detecting range may decrease when:

1. Outside air temperature is extremely hot or cold.
2. Undetectable objects smaller than 1 m (40 inches) and narrower than 14 cm (6 inches) diameter.

The following objects may not be recognized by the sensor:

1. Sharp or slim objects such as ropes, chains or small poles.
2. Objects, which tend to absorb sensor frequency such as clothes, spongy material or snow.

* NOTICE

1. The warning may not sound sequentially depending on the speed and shapes of the objects detected.
2. Forward/Reverse Parking Distance Warning may malfunction if the vehicle bumper height or sensor installation has been modified. Any non-factory installed equipment or accessories may also interfere with the sensor performance.
3. Sensor may not recognize objects less than 30 cm (12 inches) from the sensor, or it may sense an incorrect distance. Use with caution.
4. When the sensor is frozen or stained with snow or water, the sensor may be inoperative until the stains are removed using a soft cloth.
5. Do not push, scratch or strike the sensor with any hard objects that could damage the surface of the sensor. Sensor damage could occur.

*** NOTICE**

This function can only sense objects within the range and location of the sensors, it can not detect objects in other areas where sensors are not installed. Also, small or slim objects, or objects located between sensors may not be detected.

Always visually check in front and behind the vehicle when driving.

Be sure to inform any drivers in the vehicle that may be unfamiliar with the function regarding the functions capabilities and limitations.

⚠ WARNING

Pay close attention when the vehicle is driven close to objects on the road, particularly pedestrians, and especially children. Be aware that some objects may not be detected by the sensors, due to the objects distance, size or material, all of which can limit the effectiveness of the sensor. Always perform a visual inspection to make sure the vehicle is clear of all obstructions before moving the vehicle in any direction.

Self-diagnosis

When you shift the gear to the R (Reverse) position and if one or more of the below occurs you may have a malfunction in Forward/Reverse Parking Distance Warning.

- You don't hear an audible warning sound or if the buzzer sounds intermittently.
-  is displayed. (if equipped)

If this occurs, have the function checked by a professional workshop. Kia recommends to visit an authorized Kia dealer/service partner.

⚠ WARNING

Your new vehicle warranty does not cover any accidents or damage to the vehicle or injuries to its occupants related to a Forward/Reverse Parking Distance Warning.

Always drive safely and cautiously.

Declaration of conformity (if equipped)

The radio frequency components (Front Radar) complies:

For Republic of Korea



가자재의 명칭 : 특정소출력 무선기기(차량 충돌방지용 레이더 무선기기)
 모델명 : LRR-20
 인증번호 : MSIP-CMM-MF3-LRR-20
 상호 : 주식회사 만도
 제조년월일 : 2019. XX. YY
 제조자 : 주식회사 만도
 제조국 : 대한민국

ODEPV052160L

For United States and United States territories



ODEPV052161L

FCC ID

: 2ACDX-LRR-20

This device complies with Part 15 of the FCC Rules. Operation is subject to the following two conditions:

- (1) this device may not cause harmful interference, and
- (2) this device must accept any interference received, including interference that may cause undesired operation.

CAUTION TO USERS

Changes or modifications not expressly approved by the party responsible for compliance could void the user's authority to operate the equipment.

ODEPV052162L

For Europe and countries subject to CE certification



ODEPV052163L

Model : LRR-20

Hereby LRR-20 has been so constructed that it can be operated in at least one Member State without infringing applicable requirements of use of radio spectrum. (RED article 10.2)

Hereby, Mando Corp declares that the radio equipment type LRR-20 is in compliance with Directive 2014/53/EU.

The full text of the EU declaration of conformity is available at the following internet address:

<https://www.mando.com/rnd/rnd04.jsp>

ODEPV052164L

For Canada

Model: LRR-20
IC: 11988A-LRR20

This device complies with Industry Canada licence-exempt RSS standard(s). Operation is subject to the following two conditions:

- (1) this device may not cause interference, and
 - (2) this device must accept any interference, including interference that may cause undesired operation of the device.
- Le présent appareil est conforme aux CNR d'Industrie Canada applicables aux appareils radio exempts de licence. L'exploitation est autorisée aux deux conditions suivantes:
- (1) l'appareil ne doit pas produire de brouillage, et
 - (2) l'utilisateur de l'appareil doit accepter tout brouillage radioélectrique subi, même si le brouillage est susceptible d'en compromettre le fonctionnement.

ODEPV052165L

- (1) 經型式認證合格之低功率射頻電機，非經許可，公司、商號或使用者均不得擅自變更頻率、加大功率或變更原設計之特性及功能。
- (2) 低功率射頻電機之使用不得影響飛航安全及干擾合法通信；經發現有干擾現象時，應立即停用，並改善至無干擾時方得繼續使用。前項合法通信，指依電信法規定作業之無線電通信。低功率射頻電機須忍受合法通信或工業、科學及醫療用電波輻射性電機設備之干擾。

- (1) Without permission granted by NCC, any company, enterprise, or user is not allowed to change frequency, enhance transmitting power or alter original characteristic as well as performance to a approved low power radio-frequency devices.
- (2) The low power radio-frequency devices shall not influence aircraft security and interfere legal communications. If found, the user shall cease operating immediately until no interference is achieved. The said legal communications means radio communications is operated in compliance with the Telecommunications Act. The low power radio-frequency devices must be susceptible with the interference from legal communications or ISM radio wave radiated devices.

ODEPV052168L

For Japan

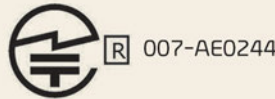

ODEPV052169L

For China

CMIIT ID : 2016DJ5872
ODEPV052166L

For Australia



ODEPV052170L

For Taiwan



ODEPV052167L

CCA119LP0500T9

For Serbia



For UAE



For Oman

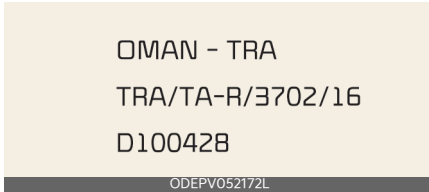

For Brazil



For Moldova



For Singapore

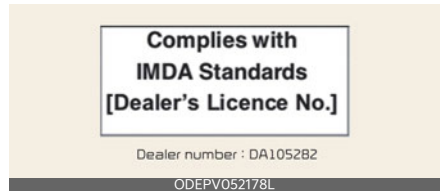

For Ukraine



For Russia

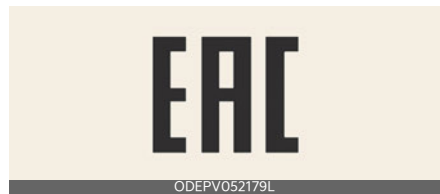

26. Manufacturers should ensure that radio equipment is accompanied by instructions and safety information in accordance with the law on the use of languages.

Instructions should include the information necessary to use the radio equipment according to its purpose. Such information contains, in the presence of a description of the components and accessories, including software that allows the radio equipment to work for its intended purpose. Such instructions and safety instructions, as well as any labeling, must be clear, understandable and legible.

An instruction for radio equipment intended to emit radio waves must additionally contain:

band (bands) of radio frequencies, in which (in which) the radio equipment operates;

the maximum radiation power in the band (s) of radio frequencies, in which (in which) radio equipment is operating.

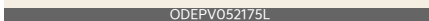

For Malaysia



For Jordan

Model : LRR-20

ODEPV052181L

For Mexico

IFETEL : RCPMALR20-0336

"La operación de este equipo está sujeta a las siguientes dos condiciones:
(1) es posible que este equipo o dispositivo no cause interferencia perjudicial y
(2) este equipo o dispositivo debe aceptar cualquier interferencia, incluyendo la que pueda causar su operación no deseada."
and RCPMALR20-0336

ODEPV052182L

For Israel

Ministry of Communication permit number :
51-57230

ODEPV052183L

The radio frequency components (Rear Corner Radar) complies:

For United States and United States territories



ODEPV052161L

UR8 303919

This device complies with Part 15 of the FCC Rules. Operation is subject to the following two conditions:

- (1) this device may not cause harmful interference, and
- (2) this device must accept any interference received, including interference that may cause undesired operation.

CAUTION TO USERS

Changes or modifications not expressly approved by the party responsible for compliance could void the user's authority to operate the equipment.

ODEPV052184L

For Canada

This Category II radiocommunication device complies with Industry Canada Standard RSS-310.

Ce dispositif de radiocommunication de catégorie II respecte la norme CNR-310 d'Industrie Canada .

This device complies with Industry Canada licence-exempt RSS standard(s). Operation is subject to the following two conditions: (1) this device may not cause interference, and (2) this device must accept any interference, including interference that may cause undesired operation of the device.

Le présent appareil est conforme aux CNR d'Industrie Canada applicables aux appareils radio exempts de licence. L'exploitation est autorisée aux deux conditions suivantes :

- (1) l'appareil ne doit pas produire de brouillage, et (2) l'utilisateur de l'appareil doit accepter tout brouillage radioélectrique subi, même si le brouillage est susceptible d'en compromettre le fonctionnement.

ODEPV052185L

For Taiwan

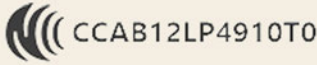

ODEPV052186L

電信法第 48 條, 低功率電波輻射性電機管理辦法

第十二條

經型式認證合格之低功率射頻電機, 非經許可, 公司、商號或使用者均不得擅自變更頻率、加大功率或變更原設計之特性及功能。

第十四條

低功率射頻電機之使用不得影響飛航安全及干擾合法通信; 經發現有干擾現象時, 應立即停用, 並改善至無干擾時方得繼續使用。前項合法通信, 指依電信法規定作業之無線電通信。低功率射頻電機須忍受合法通信或工業、科學及醫療用電波輻射性電機設備之干擾。

Article 12

Without permission, any company, firm or user shall not alter the frequency, increase the power, or change the characteristics and functions of the original design of the certified lower power frequency electric machinery.

Article 14

The application of low power frequency electric machineries shall not affect the navigation safety nor interface a legal communication, if an interference is found, the service will be suspended until improvement is made and the interference no longer exist.

ODEPV052187L

For Malaysia



RALM/26A/0216/S(16-0211)

ODEPV052188L

For Mongolia



ODEPV052189L

For Philippines



ODEPV052190L

For Singapore



N0407-13

ODEPV052191L

For Vietnam



ODEPV052192L

For Brazil



Este equipamento opera em caráter secundário, isto é, não tem direito a proteção contra interferência prejudicial, mesmo de estações do mesmo tipo, e não pode causar interferência a sistemas operando em caráter primário.

ODEPV052193L

For Mexico

IFETEL: RCPVAXT 12-1288

“La operación de este equipo está sujeta a las siguientes dos condiciones:

(1) es posible que este equipo o dispositivo no cause interferencia perjudicial y (2) este equipo o dispositivo debe aceptar cualquier interferencia, incluyendo la que pueda causar su operación no deseada.”

ODEPV052194L

For Paraguay

PARAGUAY



NR:2017-08-1-0000279

ODEPV052195L

For Ukraine



ODEPV052174L

Valeo Schalter und Sensoren GmbH заявляє, що тип радіообладнання MBHL2 відповідає технічним регламентам радіотехнічного обладнання; повний текст декларації від відповідності доступна на веб-сайті за адресою: <https://valeo.com/declaration-of-conformity/files/MBHL_TypeA_DoC_TR-RED_WUE.PDF>

ODEPV052196L

For Moldova



ODEPV052197L

For Algeria

CE + Agréé par l'ARPT:
<1247/1-LG408/DT/DGARPT/18>

ODEPV052198L

For Oman

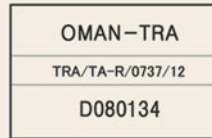

ODEPV052199L

For United Arab Emirates



ODEPV052200L

For Indonesia



ODEPV052201L

For Mozambique

Approval No : N 3/R/SRA/2018
Valeo MBHL TypeA Radar

ODEPV052202L

For Zambia



ODEPV052203L

For Argentina



CNC ID: C-20215

ODEPV052204L

For Jamaica

This product contains a Type Approved
Module by Jamaica: SMA – "MBHL1 TypeA"

ODEPV052205L

For Europe and countries subject to CE certification

Declaration of Conformity
Radiocontrolled Vehicle components



The radio frequency components of the vehicle comply with requirements and other relevant provisions of Directive 1995/5/EC.

Further information including the manufacturer's declaration of conformity is available on as follow ;
<https://valeo.com/declaration-of-conformity>

ODEPV052206L

Special driving conditions

If driving conditions deteriorate due to poor weather or road conditions, you should pay even more attention than usual.

Hazardous driving conditions

When hazardous driving conditions are encountered, such as water, snow, ice, mud, sand, or similar hazards, follow these suggestions:

- Drive cautiously and allow extra distance for braking.
- Avoid sudden braking or steering.
- Do not pump the brake pedal on a vehicle equipped with ABS.
- If stalled in snow, mud, or sand, use second gear. Accelerate slowly to avoid spinning the drive wheels.
- Use sand, rock salt, or other nonslip material under the drive wheels to provide traction when the vehicle is stuck in ice, snow, or mud.

Reducing the risk of a rollover

This multi-purpose passenger vehicle is defined as a Sports Utility Vehicle (SUV). Utility vehicles have a significantly higher rollover rate than other types of vehicles. SUVs have higher ground clearance and narrower track to make them capable of performing in a wide variety of off-road applications.

Specific design characteristics give them a higher center of gravity than ordinary vehicles. An advantage of the higher ground clearance is a better view of the road, which allows you to anticipate problems.

They are not designed for cornering at the same speeds as conventional passenger vehicles, any more than low-

slung sports vehicles are designed to perform satisfactorily in off-road conditions. Due to this risk, driver and passengers are strongly recommended to buckle their seat belts.

In a rollover crash, an unbelted person is significantly more likely to die than a person wearing a seat belt. There are precautionary measures that a driver can take to reduce the risk of rollover.

If possible, avoid sharp turns and abrupt maneuvers, do not load your roof rack with heavy cargo, and never modify your vehicle in any way.

WARNING

- Your vehicle is equipped with tires designed to provide safe ride and handling capability. Do not use tires and wheels that are different in size and type from the originally installed ones. It can affect the safety and performance of your vehicle, which could lead to steering failure or rollover and serious injury. When replacing the tires, be sure to equip all four tires with the tire and wheel of the same size, type, tread, brand and load-carrying capacity.
- As with other Sports Utility Vehicle (SUV), failure to operate this vehicle correctly may result in loss of control, an accident or vehicle rollover.
 - Utility vehicles have a significantly higher rollover rate than other types of vehicles.
 - Specific design characteristics (higher ground clearance, narrower track, etc.) give this vehicle a higher center of gravity than ordinary vehicles.
 - A SUV is not designed for cornering at the same speeds as conventional vehicles.

- Avoid sharp turns and abrupt maneuvers.
- In a rollover crash, an unbelted person is significantly more likely to die than a person wearing a seat belt. Make sure everyone in the vehicle is properly buckled up.

Rocking the vehicle

If it is necessary to rock the vehicle to free it from snow, sand, or mud, first turn the steering wheel right and left to clear the area around your front wheels. Then, shift back and forth between R (Reverse) and any forward gear position.

Do not race the vehicle, and spin the wheels as little as possible. If you are still stuck after a few tries, have the vehicle pulled out by a tow vehicle to avoid vehicle overheating and possible damage to the reduction gear.

WARNING

Do not attempt to rock the vehicle if people or objects are nearby. The vehicle may suddenly move forward or backwards as it becomes unstuck.

CAUTION

- Prolonged rocking may cause vehicle overheating, reduction gear damage or failure, and tire damage.
- Do not spin the wheels, especially at speeds more than 56 km/h (35 mph). Spinning the wheels at high speeds when the vehicle is stationary could overheat and damage tires, and the rotating wheels may fly away and injure bystanders.

* NOTICE

The Electronic Stability Control (ESC) should be turned OFF prior to rocking the vehicle.

Smooth cornering

Avoid braking or gear changing while cornering, especially when the road is wet. Ideally, corners should always be negotiated with gentle acceleration. If you follow these suggestions, tire wear will be kept to a minimum.

Driving at night

Because night driving presents more hazards than driving in the daylight, here are some important tips to remember:

- Slow down and keep more distance between you and other vehicles as it may be more difficult to see at night, especially in areas where there are no street lights.
- Adjust your mirrors to reduce the glare from other driver's headlamps.
- Keep your headlamps clean and properly aimed. (On vehicles not equipped with the automatic headlamp aiming feature.) Dirty or improperly aimed headlamps will make it much more difficult to see at night.
- Avoid staring directly at the headlamps of oncoming vehicles. You could be temporarily blinded, and it will take several seconds for your eyes to readjust to the darkness.

Driving in the rain

Rain and wet roads can make driving dangerous, especially if you are not prepared for the slick surface.

Here are a few things to consider when driving in the rain:

- A heavy rainfall will make it harder to see and will increase the distance needed to stop your vehicle, so slow down.
- Keep your windshield-wiping equipment in good shape. Replace your windshield wiper blades when they show signs of streaking or missing areas on the windshield.
- If your tires are not in good condition, having to stop quickly on a wet surface can cause a skid and possibly lead to an accident. Be sure your tires are in good shape.
- Turn on your headlamps to make it easier for others to see you.
- Driving too fast through large puddles can affect your brakes. If you must drive through puddles, try to go through them slowly.
- If you believe you got your brakes wet, apply them lightly while driving until normal brake operation returns.

Hydroplaning

If the road is wet enough and you are going fast enough, your vehicle may have little or no contact with the road surface and actually ride on the water. The best advice is to SLOW DOWN when the road is wet.

The risk of hydroplaning increases as the depth of tire tread decreases, refer to "Tire replacement" on page 8-17.

Driving in flooded areas

Avoid driving through flooded areas unless you are sure the water is no higher than the bottom of the wheel hub. Drive through any water slowly. Allow adequate stopping distance as brake performance may be affected.

After driving through water, dry the brakes by gently applying them several times while the vehicle is moving slowly.

If the brake system is wet and has reduced braking effect or frequent sounds when braking, adjust the setting for the regenerative braking to 'O' speed with paddle shifter and apply the brake pedal lightly several times. Maintain a safe distance to dry the brake system.

Setting the regenerative braking to 'O' may reduce efficiency while braking several times for brake performance, but this is normal. The regenerative braking system will be normally operated afterwards.

Highway driving

Tires

Adjust the inflation pressures of the tires in accordance with their specifications. Low tire inflation pressures will result in overheating and possible failure of the tires.

Avoid using worn or damaged tires since they may provide reduced traction or fail completely.

Never exceed the maximum tire inflation pressure shown on the tires.

⚠ WARNING

- Always check the tires for proper inflation before driving. Underinflated or overinflated tires can cause poor handling, loss of vehicle control, and sudden tire failure, leading to accidents, injuries, and even death. For proper tire pressures, refer to "Tires and wheels" on page 9-5.
- Always check the tire tread before driving your vehicle. Worn-out tires can result in loss of vehicle control. Worn-out tires should be replaced as soon as possible. For further information and tread limits, refer to "Tires and wheels" on page 8-15.

Coolant and high voltage battery

Driving at higher speeds on the highway consumes more electric energy and is less efficient than driving at a slower, more moderate speed. Maintain a moderate speed in order to conserve electric energy when driving on the highway.

Be sure to check both the coolant level and the electric energy level before driving.

Winter driving

Severe weather conditions in the winter result in greater wear and other problems.

To minimize the problems of winter driving, you should follow these suggestions:

- * Snow tires and tire chains for the national language (Icelandic), see the Appendix.

Snowy or icy conditions

To drive your vehicle in deep snow, it may be necessary to use snow tires or to install tire chains on your tires.

If snow tires are needed, it is necessary to select tires of the size and type equivalent to the tires originally installed. Failure to do so may adversely affect the safety and handling of your vehicle. Furthermore, speeding, rapid acceleration, sudden brake applications, and sharp turns are potentially very hazardous practices.

During deceleration, use vehicle braking to the fullest extent. Sudden brake applications on snowy or icy roads may cause skids to occur. You need to keep sufficient distance between your vehicle and the one in front. Also, apply the brake gently. Note that installing tire chains on the tires will provide greater driving force, but will not prevent side skids.

⚠ CAUTION

- When the battery temperature is extremely low in winter, the battery temperature optimization is conducted for normal driving conditions. The optimization time may vary depending on the battery temperature and charging conditions.

- If the high voltage battery level and temperature is too low, the power may be limited. When the warning message is displayed, please charge the vehicle immediately.



A: Charge immediately. Power limited

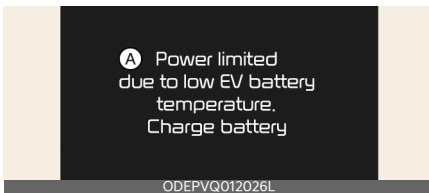

A: Power limited due to low EV battery temperature. Charge battery

Summer tires (if equipped)

- Summer tires are used to maximize the driving performance on dry roads.
- If the temperature is below 7°C or you are driving on snowy or icy roads, the summer tires lose their brake performance and traction as the tire grip weakens significantly.
- If the temperature is below 7°C or you are driving on snowy or icy roads, mount snow tires or all-season tires of the same size with your vehicle's standard tire for safe driving. Both snow and all-season tires have M+S markings.
- When using the M+S tires, use tires with the same tread produced by the same manufacturer for safe driving.

- When driving with the M+S tires with the lower maximum allowable speed than that of the vehicle's standard summer tire, be careful not to exceed the speed allowed for the M+S tires.

Snow tires

If you mount snow tires on your vehicle, make sure they are radial tires of the same size and load range as the original tires. Mount snow tires on all four wheels to balance your vehicle's handling in all weather conditions. Keep in mind that the traction provided by snow tires on dry roads may not be as high as the traction provided by the tires originally installed on your vehicle. You should drive cautiously even when the roads are clear. Check with the tire dealer for maximum speed recommendations.

Do not install studded tires without first checking all applicable regulations for possible restrictions on their use.

⚠ WARNING

Snow tires should be equivalent in size and type to the vehicle's standard tires. Otherwise, the safety and handling of your vehicle may be adversely affected.

Tire chains



Because the sidewalls of radial tires are thinner, they can be damaged by mounting some types of snow chains on them. Therefore, the use of snow tires is recommended instead of snow chains. Do not mount tire chains on vehicles equipped with aluminum wheels; snow chains may cause damage to the wheels.

Damage to your vehicle caused by improper snow chain use is not covered by your vehicle manufacturer's warranty.

When using tire chains, attach them to the drive wheels as follows.

- Front wheel drive vehicle moves the front wheel as a power source. Thus, snow chains must be mounted to front tires.
- After mounting snow chains, drive slowly. If you hear noise caused by chains contacting the body, slow down until the noise stops and remove the chain as soon as you begin driving on cleared roads to prevent damage.
- Chains of the wrong size or which are improperly installed can damage your vehicle's brake lines, suspension, body, and wheels. Therefore, when installing snow chains, follow the manufacturer's instructions and mount them as tightly possible. Drive slowly with chains installed, staying under 30 km/h (20 mph).

- Install tire chains that meet the specifications of each tire size to prevent damage your vehicle.
 - 17-inch tires use fabric snow chain.

⚠ CAUTION

- Make sure the snow chains are the correct size and type for your tires. Incorrect snow chains can cause damage to the vehicle body and suspension and may not be covered by your vehicle manufacturer warranty. Also, the snow chain connecting hooks may be damaged from contacting vehicle components causing the snow chains to come loose from the tire. Make sure the snow chains are SAE class "S" certified.
- Always check chain installation for proper mounting after driving approximately 0.5 to 1 km (0.3 to 0.6 miles) to ensure safe mounting. Retighten or remount the chains if they are loose.

Check the battery and cables

Winter places additional burden the battery system. Visually inspect the battery and cables as described in section 8. Have the level of charge in your battery checked by a professional workshop. Kia recommends visiting an authorized Kia dealer/service partner.

To keep the locks from freezing

To keep the vehicle's locks from freezing, squirt an approved de-icer fluid or glycerine into the key openings. If a lock is covered with ice, squirt it with an approved de-icing fluid to remove the ice. If the lock is frozen internally, you may be able to thaw it out by using a

heated key. Handle the heated key with care to avoid injury.

Use an approved window washer anti-freeze for the window washer system

To keep the water in the window washer system from freezing, add an approved window washer anti-freeze solution in accordance with instructions on the container. Window washer anti-freeze is available from an authorized Kia dealer/service partner and most auto parts outlets. Do not use coolant or other types of anti-freeze as these may damage the paint finish.

Do not let your parking brake freeze

Under some conditions, your parking brake can freeze in the applied position. This is most likely to happen when there is an accumulation of snow or ice around or near the rear brakes or if the brakes are wet. If there is risk of the parking brake freezing, temporarily apply it with the P (Park) gear position selected. Block the rear wheels in advance as well so that the vehicle cannot roll. Then, release the parking brake.

Do not let ice or snow accumulate underneath

Under some conditions, snow and ice can build up under the fenders and interfere with the steering. When driving in severe winter conditions where this may happen, you should periodically check underneath the vehicle to make sure the movements of the front wheels and the steering components are not obstructed.

Carry emergency equipment

Depending on the severity of the weather, you should carry appropriate emergency equipment. Some of the items you may want to carry include tire chains, tow straps or chains, flashlight, emergency flares, sand, shovel, jumper cables, window scraper, gloves, ground cloth, coveralls, blanket, etc.

Do not place objects or materials in the motor compartment

Putting objects or materials in the motor compartment may cause an motor failure. Such damage will not be covered by the manufacturer's warranty.

Vehicle weight

This section will give you guidance on the proper loading of your vehicle to keep your loaded vehicle weight within its design rating capability. Properly loading your vehicle will help you use the vehicle's design performance to maximum advantage. Before loading your vehicle, familiarize yourself with the following terms for determining your vehicle's weight ratings, which are used in the vehicle's specifications and on the certification label:

Base curb weight

This is the weight of the vehicle including all standard equipment. It does not include passengers, cargo, or optional equipment.

Vehicle curb weight

This is the weight of the vehicle including high voltage battery and all standard equipment. It does not include passengers, cargo, or optional equipment.

Cargo weight

This figure includes all weight added to the Base Curb Weight, including cargo and optional equipment.

GAW (Gross axle weight)

This is the total weight placed on each axle (front and rear) - including vehicle curb weight and all payload.

GAWR (Gross axle weight rating)

This is the maximum allowable weight that can be carried by a single axle (front or rear). These numbers are shown on the certification label (if equipped).

The total load on each axle must never exceed its GAWR.

GVW (Gross vehicle weight)

This is the base curb weight plus the actual cargo weight plus passengers.

GVWR (Gross vehicle weight rating)

This is the maximum allowable weight of the fully loaded vehicle (including all options, equipment, passengers, and cargo). The GVWR is shown on the certification label located on the driver's (or front passenger's) door sill (if equipped).

Overloading



Vehicle weight

The gross axle weight rating (GAWR) and the gross vehicle weight rating (GVWR) for your vehicle are on the Certification Label attached to the driver's (or front passenger's) door. Exceeding these ratings can cause an accident or vehicle damage. You can calculate the weight of your load by weighing the items (and people) before putting them in the vehicle. Be careful not to overload your vehicle.

Loading Your Vehicle (if equipped)

Certification Label



Tire Label



The Certification/Tire label is found on the front edge of the RH (or LH) "B" pillar. The label shows the size of your original tires and inflation pressures needed to obtain the gross weight capacity of your vehicle.

This is called the GVWR (Gross Vehicle Weight Rating). The GVWR includes the weight of the vehicle, all occupants and cargo. The Certification/Tire label also tells you the maximum weights for the front and rear axles, called Gross Axle Weight Rating (GAWR).

Never exceed the GVWR for your vehicle, or the Gross Axle Weight Rating (GAWR) for either the front or rear axle. And, if you do have a heavy load, you should spread it out.

Your warranty does not cover parts or components that fail because of overloading.

Do not load your vehicle any heavier than the GVWR or the maximum front and rear GAWRs. If you do, change to the vehicle may occur, or it can change the way your vehicle handles. These could cause you to lose control. Also, overloading can shorten the life of your vehicle.

What to do in an emergency

Road warning	7-2
• Hazard warning flasher.....	7-2
In the event of an emergency while driving	7-2
• If the vehicle stalls while driving.....	7-2
• If the vehicle stalls at a crossroad or crossing.....	7-2
• If you have a flat tire while driving.....	7-2
If the vehicle will not start	7-3
Emergency starting	7-3
• Jump-starting (12V battery).....	7-3
• Push-starting.....	7-4
Tire Pressure Monitoring System (TPMS)	7-5
• Checking the tire pressure.....	7-5
• When the telltale lights up.....	7-6
• Tire Pressure Monitoring System (TPMS) malfunction indicator.....	7-7
If you have a flat tire (with Tire Mobility Kit)	7-9
• Components of the Tire Mobility Kit.....	7-10
• Using the Tire Mobility Kit.....	7-11
• Distributing the sealant.....	7-11
• Checking tire inflation pressure.....	7-12
• Safe use of the Tire Mobility Kit.....	7-13
Towing	7-14
• Towing service.....	7-14
• Emergency towing.....	7-14
Emergency commodity	7-16

What to do in an emergency

Road warning

Hazard warning flasher



Condition(s)

- When an emergency situation occurs while driving
- Parking by the edge of the roadway

Operation

- Push the hazard warning flasher switch.

In the event of an emergency while driving

If the vehicle stalls while driving

Operation

1. Reduce your speed and keep straight.
2. Stop the vehicle in a safe place.
3. Turn the hazard warning flasher on.
4. Restart the vehicle.

If the vehicle still does not start, contact a professional workshop or seek other qualified assistance. Kia recommends to call an authorized Kia dealer/service partner.

If the vehicle stalls at a crossroad or crossing

Operation

1. Shift to N (Neutral).
2. Push the vehicle to a safe place.

If you have a flat tire while driving

Operation

1. Reduce your speed slowly and keep straight.
2. Stop the vehicle in a safe, level place away from traffic.
3. Turn the hazard warning flasher on.
4. Set the parking brake.
5. Shift to P (Park).
6. Have all passengers get out of the vehicle and move away from traffic.

Refer to "If you have a flat tire (with Tire Mobility Kit)" on page 7-9.

If the vehicle will not start

Confirm the EV battery is not low on the charge gauge.

- Be sure P (Park) gear position is selected. The vehicle starts only when P (Park) gear position is selected.
- Check the 12-volt battery connections to be sure they are clean and tight.
- Turn on the interior light. If the light dims or goes out when you operate the starter, the 12V battery is drained.

Do not push or pull the vehicle to start it. This could cause damage to your vehicle.

Emergency starting

Jump-starting (12V battery)



Condition(s)

- When the vehicle will not start due to low battery power

Operation

1. Connect the jumper cables as shown.
 - Positive (+) terminal of the flat battery (1) and the booster battery (2).
 - Negative (-) terminal of the flat battery (3) and the grounding point (4).
2. Start the vehicle with the booster battery for several minutes.
3. Try to start the vehicle with the flat battery again.
4. If the vehicle starts, disconnect the jumper cables as following:
 - Negative (-) terminal of the booster battery (3).
 - Positive (+) terminal of the booster battery (2)
 - Flat battery (1), (4).

If the vehicle still does not start, contact a professional workshop or seek other qualified assistance. Kia recommends to call an authorized Kia dealer/service partner.

⚠ WARNING

- Keep all flames or sparks away from the battery. The battery produces hydrogen gas which may explode if exposed to flame or sparks. If these instructions are not followed exactly, serious personal injury and damage to the vehicle may occur! If you are not sure how to follow this procedure, seek qualified assistance. Automobile batteries contain sulfuric acid. This is poisonous and highly corrosive. When jump starting, wear protective glasses and be careful not to get acid on yourself, your clothing or on the vehicle.
- Do not attempt to jump start the vehicle if the discharged battery is frozen or if the electrolyte level is low; the battery may rupture or explode.
- Do not allow the (+) and (-) jumper cables to touch. It may cause sparks.
- Never attempt to check the electrolyte level of the battery as this may cause the battery to rupture or explode causing serious injury.
- The battery may rupture or explode when you jump start with a low or frozen battery.
- The electrical starting system works with high voltage. NEVER touch these components with the  indicator ON or when the START/STOP button is in the ON position.

⚠ CAUTION

Use only a 12-volt jumper system. You can damage other electrical parts beyond repair by use of a 24- volt power supply (either two 12-volt batteries in series or a 24-volt motor generator set).

*** NOTICE**

Do not connect the jumper cable from the negative terminal of the booster battery to the negative terminal of the discharged battery. This can cause the discharged battery to overheat and crack, releasing battery acid. Make sure to connect one end of the jumper cable to the negative terminal of the booster battery, and the other end to a metallic point, far away from the battery.

Push-starting

Your vehicle equipped with reduction gear should not be push-started.

⚠ WARNING

Never tow a vehicle to start it. When the vehicle starts, the vehicle can suddenly surge forward and could cause a collision with the tow vehicle.

Tire Pressure Monitoring System (TPMS) (if equipped)

Checking the tire pressure



- 1 Low tire pressure telltale/Tire Pressure Monitoring System (TPMS) malfunction indicator
- 2 Low tire pressure position telltale

Operation

1. Press the cluster menu button (⌂) on the steering wheel.
2. Select 'Information mode' from the LCD display modes.

* INFORMATION

- You can change the tire pressure unit in the user settings mode on the cluster.
 - psi, kpa, bar (Refer to "LCD display" on page 5-31.)
- Each tire should be checked monthly when cold and inflated to the inflation pressure recommended by the vehicle manufacturer on the vehicle placard or tire inflation pressure label. (If your vehicle has tires of a different size than the size indicated on the vehicle placard or tire inflation pressure label, you should determine the

proper tire inflation pressure for those tires.)

As an added safety feature, your vehicle has been equipped with a tire pressure monitoring system (TPMS) that appear a low tire pressure telltale when one or more of your tires is significantly under-inflated. Accordingly, when the low tire pressure telltale appear, you should stop and check your tires as soon as possible, and inflate them to the proper pressure. Driving on a significantly under-inflated tire causes the tire to over-heat and can lead to tire failure. Under-inflation also reduces electric energy efficiency and tire tread life, and may affect the vehicle's handling and stopping ability.

Note that the TPMS is not a substitute for proper tire maintenance, and it is the driver's responsibility to maintain correct tire pressure, even if under-inflation has not reached the level to trigger illumination of the TPMS low tire pressure telltale.

Your vehicle has also been equipped with a TPMS malfunction indicator to indicate when the system is not operating properly. The TPMS malfunction indicator is combined with the low tire pressure telltale. When the system detects a malfunction, the telltale will flash for approximately 1 minute and then remain continuously appeared. This sequence will continue upon subsequent vehicle start-ups as long as the malfunction exists. When the TPMS malfunction indicator remains appeared after blinking for approximately 1 minute, the system may not be able to detect or signal low tire pressure as intended.

TPMS malfunctions may occur for a variety of reasons, including the installation of replacement or alternate tires or wheels on the vehicle that prevent the TPMS from functioning properly. Always check the TPMS malfunction telltale after replacing one or more tires or wheels on your vehicle to ensure that the replacement or alternate tires and wheels allow the TPMS to continue to function properly.

⚠ WARNING

Significantly low tire pressure makes the vehicle unstable and can contribute to loss of vehicle control and increased braking distances.

Continued driving on low pressure tires can cause the tires to overheat and fail.

⚠ CAUTION

- In winter or cold weather, the low tire pressure telltale may appear if the tire pressure was adjusted to the recommended tire inflation pressure in warm weather. It does not mean your TPMS is malfunctioning because the decreased temperature leads to a lowering of tire pressure.
- When you drive your vehicle from a warm area to a cold area or from a cold area to a warm area, or the outside temperature is higher or lower, you should check the tire inflation pressure and adjust the tires to the recommended tire inflation pressure.
- When filling tires with more air, conditions to turn off the low tire pressure telltale may not be met. This is because a tire inflator has a margin of error in performance. The low tire pressure telltale will be turned off if

the tire pressure is above the recommended tire inflation pressure.

*** NOTICE**

If any of the below happens, have the system checked by a professional workshop. Kia recommends visiting an authorized Kia dealer/service partner.

1. The low tire pressure telltale/TPMS malfunction indicator do not appear for 3 seconds when the vehicle is in ON position or vehicle is running.
2. The TPMS malfunction indicator remains appeared after blinking for approximately 1 minute.
3. The Low tire pressure position telltale remains appeared.

When the telltale lights up



A: Low tire pressure

Condition(s)

- One or more of the tires is significantly under-inflated.

Operation

- The corresponding position light will light up to indicate which tire is significantly under-inflated.
- Reduce your speed, avoid hard cornering, and anticipate increased stopping distances.
- Stop and check the tires as soon as possible.

- Inflate the tires to the specified pressure.
- Replace the underinflated tire with a spare tire if this is not possible.

Tire Pressure Monitoring System (TPMS) malfunction indicator 

Conditions

- Blinks for approximately 1 minute
 - When there is a problem with the Tire Pressure Monitoring System.

Contact a professional workshop or seek other qualified assistance. Kia recommends to call an authorized Kia dealer/service partner.

 CAUTION

- The TPMS malfunction indicator may blink for approximately 1 minute and then remain continuously appeared if the vehicle is moving around electric power supply cables or radios transmitter such as at police stations, government and public offices, broadcasting stations, military installations, airports, or transmitting towers, etc. This can interfere with normal operation of the Tire Pressure Monitoring System (TPMS).
- The TPMS malfunction indicator may blink for approximately 1 minute and then remain continuously appeared if snow chains are used or some separate electronic devices such as notebook computer, mobile charger, remote starter or navigation etc., are used in the vehicle.

This can interfere with normal operation of the Tire Pressure Monitoring System (TPMS).

*** NOTICE**

If there is a malfunction with the TPMS, the low tire pressure position telltale will not be displayed even though the vehicle has an underinflated tire.

Changing a tire equipped with Tire Pressure Monitoring System (TPMS)

Contact a professional workshop or seek other qualified assistance. Kia recommends to call an authorized Kia dealer/service partner.

*** INFORMATION**

You may not be able to identify a low tire by simply looking at it. Always use a good quality tire pressure gauge to measure the tire's inflation pressure. Note that a tire that is hot (from being driven) will have a higher pressure measurement than a tire that is cold (from sitting stationary for at least 3 hours and driven less than 1 mile (1.6 km) during that 3 hour period).

Allow the tire to cool before measuring the inflation pressure. Always be sure the tire is cold before inflating to the recommended pressure.

A cold tire means the vehicle has been sitting for 3 hours and driven for less than 1 mile (1.6 km) in that 3 hour period.

⚠ WARNING

- The TPMS cannot alert you to severe and sudden tire damage caused by external factors such as nails or road debris.
- If you feel any vehicle instability, immediately take your foot off the accelerator, apply the brakes gradually and with light force, and slowly move to a safe position off the road.
- Tampering with, modifying, or disabling the Tire Pressure Monitoring System (TPMS) components may interfere with the system's ability to warn the driver of low tire pressure conditions and/or TPMS malfunctions. Tampering with, modifying, or disabling the Tire Pressure Monitoring System (TPMS) components may void the warranty for that portion of the vehicle.

⚠ WARNING

For Europe

- Do not modify the vehicle, it may interfere with the TPMS function.
- The wheels on the market do not have a TPMS sensor. For your safety, use parts for replacement from a professional workshop. Kia recommends visiting an authorized Kia dealer/service partner.
- If you use the wheels on the market, use a TPMS sensor approved by an authorized Kia dealer.
If your vehicle is not equipped with a TPMS sensor or TPMS does not work properly, you may fail the periodic vehicle inspection conducted in your country.

- All vehicles sold in the EUROPE market during below period must be equipped with TPMS.
 - New model vehicle: Nov. 1, 2012 ~
 - Current model vehicle: Nov. 1, 2014~ (Based on vehicle registrations)

⚠ CAUTION

We recommend that you use the sealant approved by Kia if your vehicle is equipped with a Tire Pressure Monitoring System. The liquid sealant can damage the tire pressure sensors.

If you have a flat tire (with Tire Mobility Kit)



- 1 Compressor
- 2 Sealant bottle

* The tire mobility kit will be provided in the cargo area or in a dedicated bag in the tailgate in the side trim.

The Tire Mobility Kit is not designed or intended as a permanent tire repair method and is to be used for one tire only.

The system with compressor and sealing compound seals most tire punctures caused by nails or similar objects and reinflates the tire. However, larger punctures or sidewall damage cannot be sealed completely.

After ensuring that the tire is properly sealed, you can drive cautiously on the tire (for a distance of up to 200 km (120 miles)) at maximum speed of 80 km/h (50 mph) in order to reach a service station or a tire dealer to have the tire replaced.

Avoid abrupt steering or other driving maneuvers if the vehicle is heavily loaded or if a trailer is in use.

Refer to "Safe use of the Tire Mobility Kit" on page 7-13.

⚠ WARNING

- Do not use the Tire Mobility Kit to repair punctures in the tire walls. This can result in an accident due to tire failure.

- Have your tire repaired as soon as possible. The tire may lose air pressure at any time after inflating with the Tire Mobility Kit.
- Do not use the TMK if a tire is severely damaged by driving run flat or with insufficient air pressure. Only punctured areas located within the tread region of the tire can be sealed using the TMK.
- Do not use the Tire sealant after the sealant has expired (i.e. past the expiration date on the sealant container). This can increase the risk of tire failure.
- Keep the sealant out of reach of children, avoid sealant contact with eyes and do not swallow the sealant.

⚠ CAUTION

When two or more tires are flat, do not use the tire mobility kit because the supported one sealant of Tire Mobility Kit is only used for one flat tire.

Components of the Tire Mobility Kit

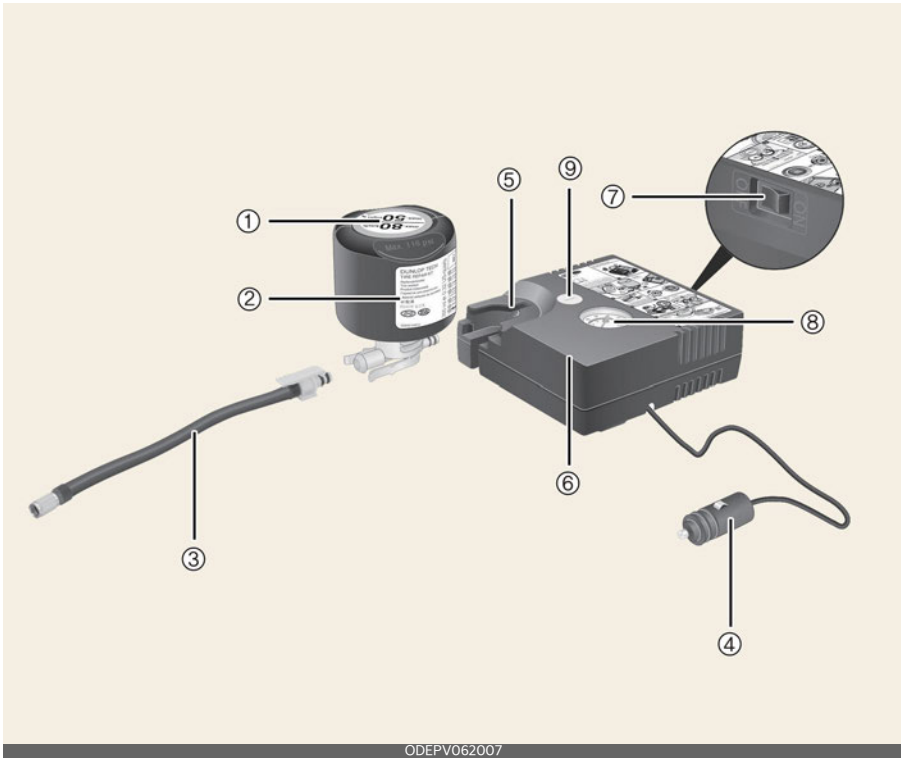

ODEPV062007

* Connectors, cable and connection hose are stored in the compressor housing.

* Strictly follow the specified sequence, otherwise the sealant may escape under high pressure.

- 1 Speed restriction label
- 2 Sealant bottle
- 3 Sealant bottle filling hose
- 4 Power outlet connector
- 5 Sealant bottle holder
- 6 Compressor
- 7 ON/OFF switch
- 8 Tire inflation pressure gauge
- 9 Tire inflation pressure valve

Using the Tire Mobility Kit

Operation

1. Shake the sealant bottle.



2. Connect the filling hose onto the connector of the sealant bottle. (A)
Connect the bottle onto the sealant bottle holder. (B)

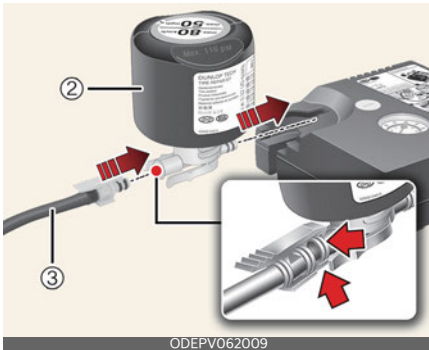

3. Make sure the compressor valve on the filling hose is locked.
4. Unscrew the valve cap and screw the filling hose onto the tire valve.



5. Make sure the compressor is turned off.
6. Connect the power outlet connector.



7. Start the vehicle.
8. Turn the compressor on and let it run for approximately 5~7 minutes to fill the sealant up to the proper pressure.
9. Turn the compressor off.
10. Detach the filling hose from the tire valve.

Distributing the sealant



Operation

- Immediately drive approximately 7~10 km (4~6 miles, or approximately 10 minutes) to distribute the tire sealant evenly.

⚠ WARNING

- Do not leave your vehicle running in a poorly ventilated area for extended periods of time. Carbon monoxide poisoning and suffocation can occur.
- If the tire pressure is below 26 psi(180 kPa), do not drive the vehicle. The tire may cause accident.

⚠ CAUTION

- Securely install the sealant filling hose to the valve. If not, sealant may flow backward, possibly clogging the filling hose.
- Do not exceed a speed of 80 km/h (50 mph). If possible, do not fall below a speed of 20 km/h (12 mph). While driving, if you experience any unusual vibration, ride disturbance or noise, reduce your speed and drive with caution until you can safely pull off of the side of the road. Call for road side service or towing. When you use the Tire Mobility Kit, the wheel may be stained by sealant. Therefore, remove the wheel stained by sealant and have the vehicle inspected at a professional workshop. Kia recommends visiting an authorized Kia dealer/service partner.

Checking tire inflation pressure

Operation

1. After driving approximately 7~10 km (4~6 miles, or approximately 10 minutes), stop the vehicle in a safe, level place.
2. Connect the filling hose directly to the tire valve.



ODEPV062010

3. Connect the power outlet connector.
4. Adjust the tire inflation pressure to the specified value.

⚠ WARNING

- Turn the compressor on to increase the inflation pressure. Turn the compressor off briefly to check the current inflation pressure.
- Press the compressor valve to reduce the inflation pressure.
- Do not let the compressor run for more than 10 minutes, otherwise the device will overheat and may be damaged.
- The tire inflation pressure must be inflated to the proper pressure (Refer to "Tires and wheels" on page 9-5). If it is not, do not continue driving. Call for road side service or towing.

⚠ CAUTION

- If the inflation pressure is not maintained, drive the vehicle a second time, refer to "Distributing the sealant" on page 7-11. Then repeat steps 1 to 4.
- Use of the TMK may be ineffectual for tire damage larger than approximately 4 mm (0.16 inches).
- We recommend that you contact a professional workshop if the tire cannot be made roadworthy with the Tire Mobility Kit.

*** NOTICE**

When reinstalling the repaired or replaced tire and wheel on the vehicle, tighten the wheel lug nut to 11~13 kgf·m (79~94 lbf·ft).

Safe use of the Tire Mobility Kit

- Stop the vehicle in a safe, level place away from traffic.
- Set the parking brake.
- Only use the Tire Mobility Kit for sealing/inflating passenger vehicle tires.
- Do not remove any foreign objects from the tire.
- Read the precautionary advice printed on the sealant bottle before using the Tire Mobility Kit.
- Leave the vehicle running. Operating the Tire Mobility Kit may drain the battery.
- Never leave the Tire Mobility Kit unattended while it is being used.
- Do not leave the compressor running for more than approximately 10 minutes at a time or it may overheat.
- Do not use the Tire Mobility Kit if the ambient temperature is below $-30\text{ }^{\circ}\text{C}$ ($-22\text{ }^{\circ}\text{F}$).
- Do not use the Tire Mobility Kit if the tire and wheel are damaged.

Technical Data

- System voltage: DC 12 V
- Working voltage: DC 12 V
- Amperage rating: max. $15\text{A}\pm 1\text{A}$
- Suitable temperatures: $-30\text{ to }70\text{ }^{\circ}\text{C}$ ($-22\text{ to }158\text{ }^{\circ}\text{F}$)
- Max. working pressure: 6 bar (87 psi)
- Size
 - Compressor: $161 \times 150 \times 55.8\text{ mm}$ ($6.3 \times 5.9 \times 2.2\text{ inches}$)
 - Sealant bottle: $104 \times 85\text{ }\varnothing\text{ mm}$ ($4.1 \times 3.3\text{ }\varnothing\text{ inches}$)
 - Compressor weight: $665\pm 30\text{ g}$ ($1.4 \pm 0.07\text{ lbs.}$)
 - Sealant volume: 300 ml (18.3 cu. in)
- * Sealant and spare parts can be obtained and replaced at an authorized vehicle or tire dealer. Empty sealant bottles may be disposed of at home. Liquid residue from the sealant should be disposed of by your vehicle or tire dealer or in accordance with local waste disposal regulations.

Towing

Towing service

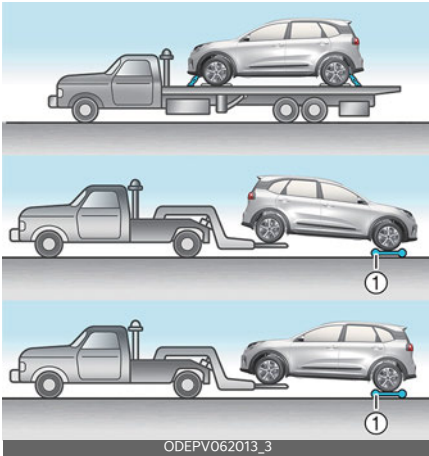

1 Dollies

Operation

- Proper lifting and towing procedures are necessary to prevent damage to the vehicle. The use of wheel dolly (1) or flatbed is recommended.
- On 2WD vehicles, it is acceptable to tow the vehicle with the rear wheels on the ground (without dollies) and the front wheels off the ground.

* INFORMATION

If emergency towing is necessary, we recommend having it done by an authorized Kia dealer or a commercial tow-truck service.

⚠ CAUTION

- Do not tow the vehicle forwards with the front wheels on the ground as this may cause damage to the vehicle.

- Do not tow with sling-type equipment. Use wheel lift or flatbed equipment.

Emergency towing

Front



Rear



Operation

1. Remove the hole cover by pressing the lower part of the cover on the bumper.
2. Install the towing hook by screwing it clockwise into the hole until it is fully secured.
3. After use, remove the towing hook and reinstall the cover.

* INFORMATION

Towing in this manner may be done only on hard-surfaced roads for a short distance and at low speed. Also, the wheels, axles, power train, steering and brakes must all be in good condition.

- Do not use the tow hooks to pull a vehicle out of mud, sand or other conditions from which the vehicle cannot be driven out under its own power.
- Avoid towing a vehicle heavier than the vehicle doing the towing.

- The drivers of both vehicles should communicate with each other frequently.
- Before emergency towing, check if the hook is not broken or damaged.
- Fasten the towing cable or chain securely to the hook.
- Do not jerk the hook. Apply it steadily and with even force.
- To avoid damaging the hook, do not pull from the side or at a vertical angle. Always pull straight ahead.
- Press the START/STOP button to the ACC position so the steering wheel is not locked.
- Shift the gear to N (Neutral).
- Release the parking brake.
- To avoid serious damage to the gear, limit the vehicle speed to 15 km/h (10 mph) and drive less than 1.5 km (1 mile) when towing.
- Press the brake pedal with more force than normal since you will have reduced brake performance.
- More steering effort will be required because the power steering system will be disabled.
- If you are driving down a long hill, the brakes may overheat and brake performance will be reduced. Stop often and let the brakes cool off.
- The driver must be in the vehicle for steering and braking operations when the vehicle is towed and passengers other than the driver must not be allowed to be on board.

WARNING

Use extreme caution when towing the vehicle.

- Avoid sudden starts or erratic driving maneuvers which would place excessive stress on the emergency towing hook and towing cable or chain. The hook and towing cable or chain may break and cause serious injury or damage.
- If the disabled vehicle is unable to be moved, do not forcibly continue the towing. We recommend that you contact an authorized Kia dealer or a commercial tow truck service for assistance.
- Tow the vehicle as straight ahead as possible.
- Keep away from the vehicle during towing.

CAUTION

- Attach a towing strap to the tow hook.
- Using a portion of the vehicle other than the tow hooks for towing may damage the body of your vehicle.
- Use only a cable or chain specifically intended for use in towing vehicles. Securely fasten the cable or chain to the towing hook provided.
- Accelerate or decelerate the vehicle in a slow and gradual manner while maintaining tension on the tow rope or chain to start or drive the vehicle, otherwise tow hooks and the vehicle may be damaged.

Emergency commodity (if equipped)

Fire extinguisher

If there is small fire and you know how to use the fire extinguisher, follow these steps carefully.

1. Pull out the safety pin at the top of the extinguisher that keeps the handle from being accidentally pressed.
2. Aim the nozzle towards the base of the fire.
3. Stand approximately 2.5 m (8 ft) away from the fire and squeeze the handle to discharge the extinguisher. If you release the handle, the discharge will stop.
4. Sweep the nozzle back and forth at the base of the fire. After the fire appears to be out, watch carefully since it may re-ignite.

First-aid kit

Scissors, bandages, adhesive tape, etc. are provided in the kit.

Reflector triangle

Place the Reflector triangle on the road to warn oncoming vehicles.

Tire pressure gauge

1. Unscrew the inflation valve cap.
2. Press and hold the gauge against the tire valve.
3. Pressing firmly will activate the gauge and avoid too much leak.
4. Adjust the inflation of the tires to the specified pressure, as necessary.
5. Reinstall the inflation valve cap.

WARNING

- When an accident occur, park the vehicle to a safe place. To avoid the leak of electricity in high voltage battery, turn the vehicle off and pull the yellow label in the high voltage battery switch to shut down the high voltage battery. Also, disconnect the auxiliary battery (12V) cable to shut-down. Be sure to disconnect both (+) cable and (-) cable.
- Do not touch the exposed electric wires. Do not touch high voltage wires (orange), connectors and other electric components.
- When an accident occur, the lethal gas and fluid from damaged high voltage battery can be leaked. Be aware not to touch or exposed to the gas and fluid. When flammable or poison gas leak inside the vehicle, open windows and evacuate to a safe place. When leaked fluid comes in contact with your eyes, flush your eyes with clean water. When the fluid contacts with your skin, wash it with salt water. Get immediate medical attention afterward.
- When the vehicle is flooded, immediately turn the vehicle off and evacuate to a safe place. For your safety we recommend to call the fire station and or visit an authorized Kia dealer/service partner.
- When the fire spread to the high voltage battery, the additional fire may occur. In this situation, be sure to accompany a fire truck when the vehicle is being towed.

Motor room compartment	8-3
Maintenance services	8-4
• Owner's responsibility.....	8-4
• Owner maintenance precautions.....	8-4
Owner maintenance schedule	8-5
• When you stop for charging.....	8-5
Scheduled maintenance service	8-6
Coolant	8-8
Brake fluid	8-8
• Checking the brake fluid level.....	8-8
Washer fluid	8-9
• Checking the washer fluid level.....	8-9
Climate control air filter	8-10
• Replacing climate control air filter.....	8-10
Wiper blades	8-11
• Replacing front wiper blade.....	8-11
• Replacing rear wiper blade.....	8-11
Battery	8-13
• For best battery service.....	8-13
• Battery capacity label.....	8-14
• Battery recharging.....	8-14
• Reset items.....	8-15
Tires and wheels	8-15
• Tire care.....	8-15
• Recommended cold tire inflation pressures.....	8-15
• Checking tire inflation pressure.....	8-16
• Tire rotation.....	8-17
• Wheel alignment and tire balance.....	8-17
• Tire replacement.....	8-17

8 Maintenance

• Compact spare tire replacement	8-17
• Wheel replacement	8-18
• Tire traction	8-19
• Tire maintenance	8-19
• Tire sidewall labeling	8-19
Fuses	8-22
• Replacing inner panel fuse	8-23
• Fuse switch	8-23
• Replacing motor room fuse	8-24
• Fuse/relay panel description	8-25
• Engine compartment fuse panel (Battery terminal cover)	8-33
Lamps	8-34
• Bulb replacement precautions	8-34
• Light position (Front)	8-36
• Light position (Rear)	8-36
• Light position (Side)	8-37
• Replacing lights (LED type)	8-37
• Replacing headlamp (Low beam/High beam) (Bulb type)	8-37
• Replacing front turn signal lamp (Bulb type)	8-38
• Replacing rear tail lamp, stop lamp, rear turn signal lamp (Bulb type)	8-38
• Replacing rear tail lamp (Bulb type)	8-39
• Replacing rear backup lamp (Bulb type)	8-40
• Replacing rear fog lamp (LED type)	8-40
• Replacing license plate lamp (Bulb type)	8-40
• Replacing map lamp (Bulb type)	8-40
• Replacing vanity mirror lamp (Bulb type)	8-41
• Replacing room lamp (Bulb type)	8-41
• Replacing luggage lamp (Bulb type)	8-41
Appearance care	8-42
• Exterior care	8-42
• Interior care	8-46

Maintenance

Motor room compartment

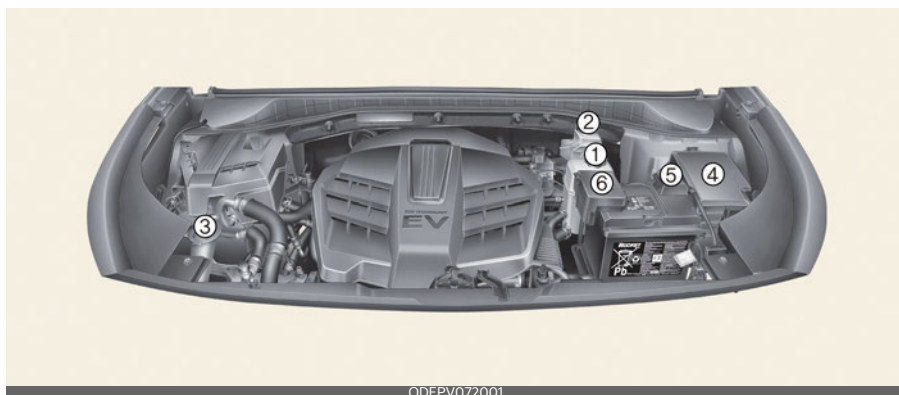

* The actual features in your vehicle may not necessarily be available due to the selected options or regions.

- 1 Coolant reservoir
- 2 Brake fluid reservoir
- 3 Windshield washer fluid reservoir
- 4 Fuse box
- 5 Negative battery terminal (-)
- 6 Positive battery terminal (+)
- 7 Front trunk

Maintenance services

Owner's responsibility

- Have your vehicle serviced by a professional workshop. Kia recommends visiting an authorized Kia dealer/service partner.
- Retain documents that show proper maintenance.
- Establish your compliance with the servicing and maintenance requirements of your vehicle warranties.
- Repairs and adjustments required as a result of improper maintenance or lack of required maintenance are not covered even when your vehicle's warranty has not yet expired.

* NOTICE

Maintenance Service and Record Retention are the owner's responsibility.

Owner maintenance precautions

Improper or incomplete service may result in problems. This section gives instructions only for the maintenance items that are easy to perform.

⚠ WARNING

- Performing maintenance work on a vehicle can be dangerous. You can be seriously injured while performing some maintenance procedures. If you lack sufficient knowledge and experience or the proper tools and equipment to do the work, have the system serviced by a professional workshop. Kia recommends visiting an authorized Kia dealer/service partner.

- Working under the hood with the vehicle running is dangerous. It becomes even more dangerous when you wear jewelry or loose clothing. These can become entangled in moving parts and result in injury. Therefore, if you must run the vehicle while working under the hood, make certain that you remove all jewelry (especially rings, bracelets, watches, and necklaces) and all neckties, scarves, and similar loose clothing before getting near the vehicle or cooling fans.

⚠ CAUTION

- Before touching the battery and electrical wiring, you should disconnect the battery (-) terminal. You may get an electric shock from the electric current.
- When you remove the interior trim cover with a flat-blade screwdriver, be careful not to damage the cover.
- Be careful when you replace and clean bulbs to avoid burns or electrical shock.

* NOTICE

Improper owner maintenance during the warranty period may affect warranty coverage. For details, read the separate Warranty & Maintenance book provided with the vehicle. If you're unsure about any servicing or maintenance procedure, have the system serviced by a professional workshop. Kia recommends visiting an authorized Kia dealer/service partner.

Owner maintenance schedule

When you stop for charging

- Check the coolant level in the coolant reservoir.
- Check the windshield washer fluid level.
- Look for low or underinflated tires.

WARNING

Be careful when checking your coolant level when the motor compartment is hot. Scalding hot coolant and steam may blow out under pressure. This could cause burns or other serious injury.

While operating your vehicle

- Check for vibrations in the steering wheel. Notice any increased steering effort or looseness in the steering wheel, or change in its straight ahead position.
- Notice if your vehicle constantly turns slightly or "pulls" to one side when traveling on smooth, level road.
- When stopping, listen and check for unusual sounds, pulling to one side, increased brake pedal travel, and "hard-to-push" brake pedal.
- If any slipping or changes in the operation of your gear shift occurs, check the gear fluid level.
- Check the parking brake.
- Check for fluid leaks under your vehicle (water dripping from the air conditioning system during or after use is normal).

At least monthly

- Check the coolant level in the coolant reservoir.
- Check the operation of all exterior lights, including the stoplights, turn signals and hazard warning flashers.
- Check the inflation pressures of all tires including the spare and look for tires that are worn or which show uneven wear or damage.
- Check for loose wheel lug nuts.

At least twice a year

- Check the cooling system, heater, and air conditioning hoses for leaks or damage.
- Check the windshield washer spray and wiper operation. Clean the wiper blades with clean cloth dampened with washer fluid.
- Check the headlamp alignment.
- Check the lap/shoulder belts for wear and proper functioning.

At least once a year

- Clean the body and door drain holes.
- Lubricate the door hinges and hood hinges.
- Lubricate the locks and latches of the doors and hood.
- Lubricate the door rubber weatherstrips.
- Check the air conditioning system.
- Inspect and lubricate the shift gear linkage and controls.
- Clean the battery and terminals.
- Check the brake fluid level.

Scheduled maintenance service

Normal maintenance schedule - except Europe

I: Inspect and adjust, correct, clean, or replace if necessary.

R: Replace or change.

Number of months or driving distance, whichever comes first									
Months	12	24	36	48	60	72	84	96	
Miles×1,000	10	20	30	40	50	60	70	80	
Km×1,000	15	30	45	60	75	90	105	120	
Coolant ^{†2}	Replace every 60,000 km (40,000 miles) or 36 months								
Reduction gear fluid	-	-	-	I	-	-	-	I	
Drive shafts and boots	-	I	-	I	-	I	-	I	
Cooling system ^{†3}	I	I	I	I	I	I	I	I	
Air conditioner refrigerant/compressor (if equipped)	I	I	I	I	I	I	I	I	
Climate control air filter	For Australia, New Zealand	I	R	I	R	I	R	I	R
	Except Australia, New Zealand	R	R	R	R	R	R	R	R
Brake discs and pads ^{†4}	-	I	-	I	-	I	-	I	
Brake lines, hoses and connections	-	I	-	I	-	I	-	I	
Brake fluid	For Australia, New Zealand	I	R	I	R	I	R	I	R
	Except Australia, New Zealand	I	I	R	I	I	R	I	I
Steering gear rack, linkage and boots	I	I	I	I	I	I	I	I	
Suspension ball joints	I	I	I	I	I	I	I	I	
Tire (pressure & tread wear)	I	I	I	I	I	I	I	I	
12V Battery condition	I	I	I	I	I	I	I	I	

* 1: When the coolant level is low, have the reservoir filled by an authorized Kia dealer/ service partner by using only designated coolant water for electric vehicles. Using other types of water or antifreeze can cause serious damage to the vehicle.

* 2: For your convenience, it can be replaced prior to its interval when you are doing other maintenance tasks.

* 3: We recommend that the coolant level and leak is checked on a daily basis.

* 4: **Brake discs and pads**

Check the pads for excessive wear, discs for run out and wear, and calipers for fluid leakage.

For more information on checking the pads or lining wear limit, we recommend to refer to the Kia web site.

(www.kia-hotline.com)

Maintenance under severe usage conditions - except Europe

I: Inspect and adjust, correct, clean, or replace if necessary.

R: Replace or change.

Maintenance Item	Maintenance Operation	Maintenance Intervals	Driving Condition
Reduction gear fluid	R	Every 120,000 km (80,000 miles)	A, B, E, F, H, J
Drive shaft and boots	I	Inspect more frequently depending on the condition	B, C, D, E, F, G, H, I
Climate control air filter	R	Replace more frequently depending on the condition	B, D, F
Brake discs, pads and calipers	I	Inspect more frequently depending on the condition	B, C, D, F, G, H, I, J
Steering-gear rack, linkage, and boots	I	Inspect more frequently depending on the condition	C, D, E, F, G
Suspension ball joints	I	Inspect more frequently depending on the condition	B, C, D, E, F

Severe driving conditions

- A. Repeatedly driving short distance of less than 8 km (5 miles) in normal temperature or less than 16 km (10 miles) in freezing temperature
- B. Driving on rough, dusty, muddy, unpaved, graveled or salt spread roads
- C. Driving in areas using salt or other corrosive materials or in very cold weather
- D. Driving in heavy dust condition
- E. Driving in heavy traffic area with the ambient temperature higher than 32 °C (90 °F) while consuming more than 50% of electric energy.
- F. Driving on uphill, downhill, or mountain roads repeatedly
- G. Towing a trailer, or using a camper or roof rack
- H. Driving as a patrol car, taxi, other commercial use or vehicle towing
- I. Frequently driving under high speed or rapid acceleration/deceleration
- J. Frequently driving in stop-and-go conditions

Coolant



Check the condition and connections of all the cooling system hoses and heater hoses. Replace any swollen or deteriorated hoses.

The coolant level should be filled between the MAX or F and the MIN or L marks on the side of the coolant reservoir when the parts in the motor compartment is cool.

If the coolant is low, we recommend to visit an authorized Kia dealer/service partner.

⚠ WARNING



The electric motor for the cooling fan may continue to operate or start up

when the vehicle is not running and can cause serious injury.

Keep hands, clothing and tools away from the rotating fan blades of the cooling fan.

The electric motor for the cooling fan is controlled by vehicle coolant temperature, refrigerant pressure and vehicle speed. As the vehicle coolant temperature decreases, the electric motor will automatically shut off. This is a normal condition.

Brake fluid

Checking the brake fluid level



Operation

- Clean the area around the reservoir cap.
- Periodically check that the fluid level in the brake fluid reservoir is between MIN and MAX. The level will fall as the vehicle's mileage increases. This is a normal condition associated with the wear of the brake linings.

Use only the specified brake fluid. (Refer to "Recommended lubricants and capacities" on page 9-6.)

*** INFORMATION**

If the fluid level is excessively low, have the system checked by a professional workshop. Kia recommends visiting an authorized Kia dealer/service partner.

⚠ WARNING

- In the event the brake system requires frequent additions of fluid, have the system inspected by a professional workshop. Kia recommends visiting an authorized Kia dealer/service partner.
- When changing and adding brake fluid, handle it carefully. Do not let it come in contact with your eyes. If brake fluid should come in contact with your eyes, immediately flush them with a large quantity of fresh tap water. Have your eyes examined by a doctor as soon as possible.

⚠ CAUTION

Do not allow brake fluid to contact the vehicle's body paint, as paint damage will result. Brake fluid, which has been exposed to open air for an extended time should never be used as its quality cannot be guaranteed. It should be properly disposed. Don't put in the wrong kind of fluid. A few drops of mineral-based oil in your brake system can damage brake system parts.

Washer fluid

Checking the washer fluid level

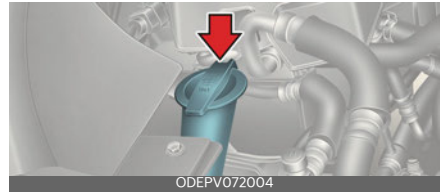

Operation

- Check the fluid level in the washer fluid reservoir and add fluid if necessary.
- Plain water may be used if washer fluid is not available.

However, use washer solvent with antifreeze characteristics in cold climates to prevent freezing.

The reservoir is translucent so that you can check the level with a quick visual inspection.

⚠ WARNING

- Do not use coolant or antifreeze in the washer fluid reservoir.
- Coolant can severely obscure visibility when sprayed on the windshield and may cause loss of vehicle control or damage to paint and body trim.
- Windshield Washer fluid agents contain some amounts of alcohol and can be flammable under certain circumstances. Do not allow sparks or flame to contact the washer fluid or the washer fluid reservoir. Damage to the vehicle or occupants could occur.
- Windshield washer fluid is poisonous to humans and animals. Do not drink and avoid contacting windshield washer fluid. Serious injury or death could occur.

Climate control air filter

Replacing climate control air filter

Operation

1. Open the glove box and remove the stoppers on both sides.

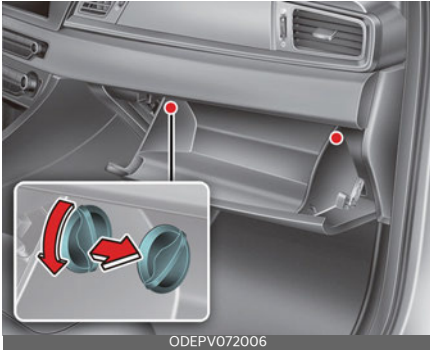

2. Open the glove box and pull the support strap (1).

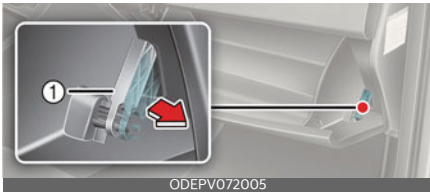

3. Remove the climate control air filter cover by pulling out both sides of the cover.



4. Replace the climate control air filter. Assemble in reverse order.



* NOTICE

- When replacing the climate control air filter install it properly. Otherwise, the system may produce noise and the effectiveness of the filter may be reduced.
- If the vehicle is operated in extremely dusty or sandy areas, replace the element more often than the usual recommended intervals.

Wiper blades

Replacing front wiper blade

Operation

Type A (if equipped)

1. Raise the wiper arm and turn the wiper blade assembly to expose the plastic locking clip.



2. Compress the clip and slide the blade assembly downward.

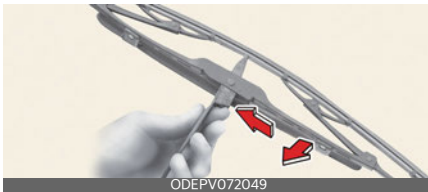

3. Lift it off the arm.
4. Install the blade assembly in the reverse order of removal.
5. Install the new blade assembly.



6. Return the wiper arm on the wind-shield.
7. Turn the vehicle on and wiper arms will return to the normal operating position.

Type B (if equipped)

1. Raise the wiper arm.
2. Lift the wiper blade clip up (1). Pull down the blade assembly and remove it (2).



3. Install the new blade assembly.

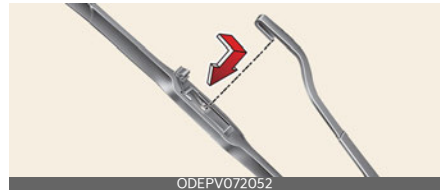

4. Upon starting the vehicle, the wiper arms will return to their normal operating position.

Replacing rear wiper blade

Operation

1. Raise the wiper arm and pull out the wiper blade assembly.



2. Lift up the wiper blade, and pull the blade to remove it.

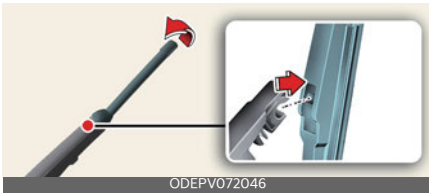

3. Install the new blade assembly by inserting the center part into the slot in the wiper arm until it clicks into place.



If the replacement is complete, put down the wiper arm to place it on the rear windshield, and turn the vehicle to ON position and operate the wipers to check the blade is installed correctly.

4. Make sure the blade assembly is installed firmly by trying to pull it slightly.

* INFORMATION

To prevent damage to the wiper arms or other components, have the wiper blade replaced by a professional workshop. Kia recommends to visit an authorized Kia dealer/service partner.

⚠ CAUTION

- Do not use gasoline, kerosene, paint thinner, or other solvents on or near them.
- Do not attempt to move the wipers manually.
- The use of a non-specified wiper blade could result in wiper malfunction and failure.
- Do not allow the wiper arm to fall against the windshield, since it may chip or crack the windshield.
- If the wiper arm receives too much force while pulling the blade, the center part may be damaged.
- The wiper could not operate for approximately 10 seconds when the wiper is operated without washer fluid or the blades are frozen. This is not a malfunction, it is a wiper protection system activated by motor overload circuit within the wiper motor.
- The front windshield should be cleaned with water hose and wiped with clean towel with wiper blades raised up. Also, the wiper blades should be wiped clean when the grease or wax is applied to the blades.

* NOTICE

Commercial hot waxes applied by automatic car washes have been known to make the windshield difficult to clean. And it is the responsibility of customers to wash and manage the vehicle with adequate methods and materials.

Battery

For best battery service



- Keep the battery securely mounted.
- Keep the top of the battery clean and dry.
- Keep the terminals and connections clean, tight, and coated with petroleum jelly or terminal grease.
- Immediately rinse any electrolyte spilled from the battery using a solution of water and baking soda.
- If the vehicle is not going to be used for an extended period, disconnect the battery cables.

⚠ WARNING



Always read the following instructions carefully when handling a battery.



Keep lighted cigarettes and all other flames or sparks away from the battery.



Hydrogen, a highly combustible gas, is always present in battery cells and may explode if ignited.



Keep batteries out of the reach of children because batteries contain highly corrosive SULFURIC ACID. Do not allow battery acid to contact your skin, eyes, clothing or paint finish.



If any electrolyte gets into your eyes, flush your eyes with clean water for at least 15 minutes and get immediate medical attention. If electrolyte gets on your skin, thoroughly wash the contacted area. If you feel pain or burning sensation, get medical attention immediately.



Wear eye protection when charging or working near a battery. Always provide ventilation when working in an enclosed space.



An inappropriately disposed battery can be harmful to the environment and human health. Dispose the battery according to your local law(s) or regulation.

- When lifting a plastic-cased battery, excessive pressure on the case may cause battery acid to leak, resulting in personal injury. Lift with a battery carrier or with your hands on opposite corners.
- Never attempt to recharge the battery when the battery cables are connected.
- The electrical ignition system works with high voltage. Never touch these components with the (🔌) indicator ON or when the START/STOP button is in the ON position.

Failure to follow the above warnings can result in serious bodily injury or death.

⚠ CAUTION

If you connect unauthorized electronic devices to the battery, the battery may be discharged. Never use unauthorized devices.

*** NOTICE**

Your vehicle is equipped with maintenance free battery. If your vehicle is equipped with the battery marked with LOWER and UPPER on the side, you can check the electrolyte level. The electrolyte level should be between LOWER and UPPER. If the electrolyte level is low, it needs to add distilled (demineralized) water (Never add sulfuric acid or other electrolyte). When refill, be careful not to splash the battery and adjacent components. And do not overfill the battery

cells. It can cause corrosion on other parts. Make sure that the cell caps are tightened.

Contact a professional workshop. Kia recommends visiting an authorized Kia dealer/service partner.

Battery capacity label

Example



* The actual battery label in the vehicle may differ from the illustration.

- 1 The Kia model name of battery
- 2 The nominal capacity (in Ampere hours)
- 3 The nominal reserve capacity (in min.)
- 4 The nominal voltage
- 5 The cold-test current in amperes by SAE
- 6 The cold-test current in amperes by EN

Battery recharging

Your vehicle has a maintenance-free, calcium-based battery.

- If the battery becomes discharged in a short time (because, for example, the headlights or interior lights were left on while the vehicle was not in use), run the vehicle for at least approximately 60 minutes while driving or at idle.

Also, connect the fully automatic regulated charger to the 12V battery located in the motor room compartment.

- If the battery gradually discharges because of high electric load while the vehicle is being used, recharge it at 20~30 A for 2 hours.

⚠ WARNING

- When recharging the battery, observe the following precautions:
 - The battery must be removed from the vehicle and placed in an area with good ventilation.
 - Do not allow cigarettes, sparks, or flame near the battery.
 - Watch the battery during charging, and stop or reduce the charging rate if the battery cells begin gassing (boiling) violently or if the temperature of the electrolyte of any cell exceeds 49°C (120°F).
 - Wear eye protection when checking the battery during charging.
 - Disconnect the battery charger in the following order.
 1. Turn off the battery charger main switch.
 2. Unhook the negative clamp from the negative battery terminal.
 3. Unhook the positive clamp from the positive battery terminal.
- Before performing maintenance or recharging the battery, turn off all accessories and stop the vehicle.
- The negative battery cable must be removed first and installed last when the battery is disconnected.
- We recommend that you use batteries for replacement from an authorized Kia dealer/service partner.

Reset items

Items should be reset after the battery has been discharged or the battery has been disconnected.

- Auto up/down window
- Trip computer
- Climate control system
- Infotainment system

Tires and wheels

Tire care

For proper maintenance, safety, and maximum electric energy economy, you must always maintain recommended tire inflation pressures and stay within the load limits and weight distribution recommended for your vehicle.

Recommended cold tire inflation pressures

Type A



Type B



All specifications (sizes and pressures) can be found on a label attached to the vehicle.

* INFORMATION

All tire pressures (including the spare) should be checked when the tires are cold. "Cold Tires" means the vehicle has not been driven for at least three hours or driven less than 1.6 km (1 mile).

Checking tire inflation pressure

- Remove the valve cap from the tire valve stem. Press the tire gauge firmly onto the valve to get a pressure measurement. If the pressure is low, add air until you reach the recommended amount.
- If you overfill the tire, release air by pushing on the metal stem in the center of the tire valve. Be sure to put the valve caps back on the valve stems.

⚠ WARNING

- Overinflation or underinflation can reduce tire life, adversely affect vehicle handling, and lead to sudden tire failure. This could result in loss of vehicle control and potential injury.
 - Severe underinflation (70 kPa (10 psi) or more) can lead to severe heat build-up, causing blowouts, tread separation and other tire failures that can result in the loss of vehicle control leading to severe injury or death. This risk is much higher on hot days and when driving for long periods at high speeds.
 - Inspect your tires frequently for proper inflation as well as wear and damage. Always use a tire pressure gauge.
 - Tires with too much or too little pressure wear unevenly causing poor handling, loss of vehicle control, and sudden tire failure leading to accidents, injuries, and even death. The recommended cold tire pressure for your vehicle can be found in this manual and on the tire label located on the driver's side center pillar.
 - Worn tires can cause accidents. Replace tires that are worn, show uneven wear, or are damaged.
- Remember to check the pressure of your spare tire. Kia recommends that you check the spare every time you check the pressure of the other tires on your vehicle.

⚠ CAUTION

- Underinflation also results in excessive wear, poor handling and reduced electric energy economy. Wheel deformation also is possible. Keep your tire pressures at the proper levels. If a tire frequently needs refilling, have the system checked by a professional workshop. Kia recommends to visit an authorized Kia dealer/service partner.
- Overinflation produces a harsh ride, excessive wear at the center of the tire tread, and a greater possibility of damage from road hazards.
- Warm tires normally exceed recommended cold tire pressures by 28 to 41 kPa (4 to 6 psi). Do not release air from warm tires to adjust the pressure or the tires will be underinflated.
- Be sure to reinstall the tire inflation valve caps. Without the valve cap, dirt or moisture could get into the valve core and cause air leakage. If a valve cap is missing, install a new one as soon as possible.
- Always observe the following:
 - Check tire pressure when the tires are cold. (After vehicle has been parked for at least three hours or hasn't been driven more than 1.6 km (one mile) since startup.)
 - Check the pressure of your spare tire each time you check the pressure of other tires.
 - Never overload your vehicle. Be careful not to overload a vehicle

luggage rack if your vehicle is equipped with one.

- Worn, old tires can cause accidents. If your tread is badly worn, or if your tires have been damaged, replace them.

Tire rotation

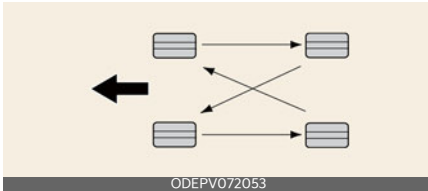

To equalize tread wear, it is recommended that the tires be rotated every 10,000 km (6,500 miles) or sooner if irregular wear develops.

WARNING

- Do not use the compact spare tire for tire rotation.
- Do not mix bias ply and radial ply tires under any circumstances. This may cause unusual handling characteristics that could result in death, severe injury, or property damage.

*** NOTICE**

Rotate radial tires that have an asymmetric tread pattern only from front to rear and not from right to left.

Wheel alignment and tire balance

The wheels on your vehicle were aligned and balanced carefully at the factory to give you the longest tire life and best overall performance.

If you notice your vehicle vibrating when driving on a smooth road, your wheels may need to be rebalanced.

CAUTION

Improper wheel weights can damage your vehicle's aluminum wheels. Use only approved wheel weights.

Tire replacement

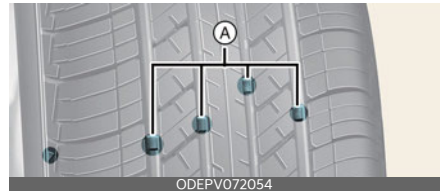

A: Tread wear indicator

If the tire is worn evenly, a tread wear Indicator will appear as a solid band across the tread.

This shows there is less than 1.6 mm (1/16 in.) of tread left on the tire. Replace the tire when this happens.

Do not wait for the band to appear across the entire tread before replacing the tire.

Compact spare tire replacement (if equipped)

A compact spare tire has a shorter tread life than a regular size tire. Replace it when you can see the tread wear indicator bars on the tire. The replacement compact spare tire should be the same size and design tire as the one provided with your new vehicle and should be mounted on the same compact spare tire wheel. The compact spare tire is not designed to be mounted on a regular size wheel, and the compact spare tire wheel is not designed for mounting a regular size tire.

⚠ WARNING

To reduce the chance of serious or fatal injuries from an accident caused by tire failure or loss of vehicle control:

- Replace tires that are worn, show uneven wear, or are damaged. Worn tires can cause loss of braking effectiveness, steering control, and traction.
- Do not drive your vehicle with too little or too much pressure in your tires. This can lead to uneven wear and tire failure.
- When replacing tires, never mix radial and bias-ply tires on the same car. You must replace all tires (including the spare) if moving from radial to bias-ply tires.
- It is best to replace all four tires at the same time. If that is not possible, or necessary, then replace the two front or two rear tires as a pair.

Replacing just one tire can seriously affect your vehicle's handling.

- Using tires and wheels other than the recommended sizes could cause unusual handling characteristics and poor vehicle control, resulting in a serious accident.
- Wheels that do not meet Kia's specifications may fit poorly and result in damage to the vehicle or unusual handling and poor vehicle control.
- The ABS works by comparing the speed of the wheels. The tire size affects wheel speed. When replacing tires, all 4 tires must use the same size, type, construction and tread pattern originally supplied with the vehicle. Using tires of a different size can cause the ABS (Anti-lock Brake Sys-

tem) and ESC (Electronic Stability Control) to work irregularly.

⚠ CAUTION

When replacing the tires, recheck and tighten the wheel nuts after driving about 50 km (31 miles) and recheck after driving about 1,000 km (620 miles). If the steering wheel shakes or the vehicle vibrates while driving, the tire is out of balance. Align the tire balance. If the problem is not solved, contact a professional workshop. Kia recommends to visit an authorized Kia dealer/service partner.

*** NOTICE**

We recommend that when replacing tires, use the same originally supplied with the vehicles. If not, that affects driving performance.

Wheel replacement

Make sure the new wheels are equivalent to the original factory units in diameter, rim width and offset.

⚠ WARNING

A wheel that is not the correct size may adversely affect wheel and bearing life, braking and stopping abilities, handling characteristics, ground clearance, body-to-tire clearance, snow chain clearance, speedometer and odometer calibration, headlight aim and bumper height.

Tire traction

Tire traction can be reduced if you drive on worn tires, tires that are improperly inflated or on slippery road surfaces. Tires should be replaced when tread wear indicators appear. Slow down whenever there is rain, snow or ice on the road to reduce the possibility of losing control of the vehicle.

Tire maintenance

In addition to proper inflation, correct wheel alignment helps to decrease tire wear. If you find a tire is worn unevenly, have a professional workshop check the wheel alignment. Kia recommends to visit an authorized Kia dealer/service partner.

When you have new tires installed, make sure they are balanced. This will increase vehicle ride comfort and tire life. Additionally, a tire should always be rebalanced if it is removed from the wheel.

Tire sidewall labeling

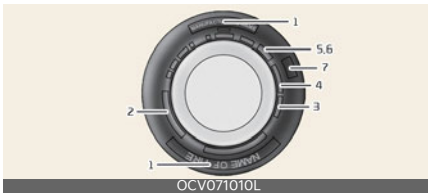

This information identifies and describes the fundamental characteristics of the tire and also provides the tire identification number (TIN) for safety standard certification. The TIN can be used to identify the tire in case of a recall.

1. Manufacturer or brand name

Manufacturer or brand name is shown.

2. Tire size designation

A tire's sidewall is marked with a tire size designation. You will need this information when selecting replacement tires for your vehicle.

Example tire size designation:

(These numbers are provided as an example only.)

P215/55R17 108T

215 - Tire width in millimeters.

55 - Aspect ratio. The tire's section height as a percentage of its width.

R - Tire construction code (Radial).

17 - Rim diameter in inches.

108 - Load Index, a numerical code associated with the maximum load the tire can carry.

T - Speed Rating Symbol. See the speed rating chart in this section for additional information.

Wheel size designation

Wheels are also marked with important information that you need if you ever have to replace one. The following explains what the letters and numbers in the wheel size designation mean.

Example wheel size designation:

7.0JX17

7.0 - Rim width in inches.

J - Rim contour designation.

17 - Rim diameter in inches.

Tire speed ratings

The chart below lists many of the different speed ratings currently being used for passenger car tires. The speed rating is part of the tire size designation on the sidewall of the tire. This symbol corresponds to that tire's designed maximum safe operating speed.

Speed Rating Symbol	Maximum Speed
S	180 km/h (112 mph)
T	190 km/h (118 mph)
H	210 km/h (130 mph)
V	240 km/h (149 mph)
W	270 km/h (168 mph)
Y	300 km/h (186 mph)

3. Checking tire life (TIN: Tire Identification Number)

Any tires that are over 6 years old, based on the manufacturing date, should be replaced by new ones. You can find the manufacturing date on the tire sidewall, displaying the DOT Code. The manufacturing date is designated by the last four digits (characters) of the DOT code.

DOT: XXXX XXXX OOOO

The front part of the DOT means a plant code number, tire size and tread pattern and the last four numbers indicate week and year manufactured.

For example, DOT XXXX XXXX 1622 represents that the tire was produced in the 16th week of 2022.

WARNING

Tires degrade over time, even when they are not being used. Regardless of the remaining tread, we recommend that tires be replaced after approximately 6 years of normal service. Heat caused by hot climates or frequent high loading conditions can accelerate the aging process. Failure to follow this warning can result in sudden tire failure, which could lead to a loss of control and an accident involving serious injury or death.

4. Tire ply composition and material

The number of layers or plies of rubber-coated fabric in the tire. Tire manufacturers also must indicate the materials in the tire, which include steel, nylon, polyester, and others. The letter "R" means radial ply construction; the letter "D" means diagonal or bias ply construction; and the letter "B" means belted-bias ply construction.

5. Maximum permissible inflation pressure

This number is the greatest amount of air pressure that should be put in the tire. Do not exceed the maximum permissible inflation pressure. Refer to "Tires and wheels" on page 9-5.

6. Maximum load rating

This number indicates the maximum load in kilograms and pounds that can be carried by the tire. When replacing the tires on the vehicle, always use a tire that has the same load rating as the factory installed tire.

7. Uniform tire quality grading

Quality grades can be found where applicable on the tire sidewall between tread shoulder and maximum section width.

For example:

TREADWEAR 200
TRACTION AA
TEMPERATURE A

WARNING

- The traction grade assigned to this tire is based on straight ahead braking traction tests, and does not include acceleration, cornering, hydroplaning, or peak traction characteristics.
- The temperature grade for this tire is established for a tire that is properly inflated and not overloaded. Excessive speed, under inflation, or excessive loading, either separately or in combination, can cause heat build-up in tire and sudden tire failure. This can cause loss of vehicle control and serious injury or death.

Tread wear

The tread wear grade is a comparative rating based on the wear rate of the tire when tested under controlled conditions on a specified government test course. For example, a tire graded 150 would wear one-and-a-half times (1½) as well on the government course as a tire graded 100.

The relative performance of tires depends upon the actual conditions of their use, however, and may depart significantly from the norm due to variations in driving habits, service practices and differences in road characteristics and climate.

The tires available as standard or optional equipment on your vehicle may vary with respect to grade.

Traction - AA, A, B & C

The traction grades, from highest to lowest, are AA, A, B and C. Those grades represent the tire's ability to stop on wet pavement as measured under controlled conditions on specified government test surfaces of asphalt and concrete. A tire marked C may have poor traction performance.

Temperature -A, B & C

The temperature grades are A (the highest), B, and C, representing the tire's resistance to the generation of heat and its ability to dissipate heat when tested under controlled conditions on a specified indoor laboratory test wheel.

Sustained high temperature can cause the material of the tire to degenerate and reduce tire life, and excessive temperature can lead to sudden tire failure. Grades B and A represent higher levels of performance on the laboratory test wheel than the minimum required by law.

Fuses

Blade type



Cartridge type



Multi fuse

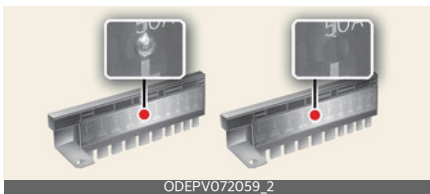

BFT

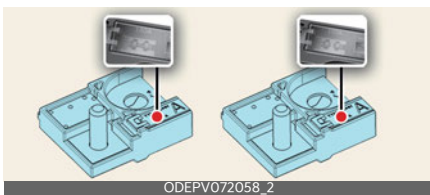

* Left: Normal, Right: Blown

* The actual fuse/relay panel label may differ.

Before replacing a blown fuse, disconnect the negative battery cable. If the electrical system does not work, first check the driver's side fuse panel. Always replace a blown fuse with one of the same rating.

If the replacement fuse blows, this indicates an electrical problem. Avoid using the system involved and immediately consult a professional workshop. Kia recommends to consult an authorized Kia dealer/service partner.

⚠ WARNING

- Never replace a fuse with anything but another fuse of the same rating.
- A higher capacity fuse could cause damage and possibly a fire.
- Never install a wire or aluminum foil instead of the proper fuse even as a temporary repair. It may cause extensive wiring damage and a possible fire.
- Do not arbitrarily modify or add-on electric wiring of the vehicle.

⚠ CAUTION

- When replacing a blown fuse or relay with a new one, make sure the new fuse or relay fits tightly into the clips. The incomplete fastening fuse or relay may cause the vehicle wiring and electric systems damage and a possible fire.
- Do not remove fuses, relays and terminals fastened with bolts or nuts. The fuses, relays and terminals may be fastened incompletely, and it may cause a possible fire. If fuses, relays and terminals fastened with bolts or nuts are blown, consult a professional workshop. Kia recommends to consult an authorized Kia dealer/service partner.
- Do not input any other objects except fuses or relays into fuse/relay terminals such as a driver or wiring. It may cause contact failure and system malfunction.

- Do not plug in screwdrivers or after-market wiring into the terminal originally designed for fuse and relays only. The electrical system and wiring of the vehicle interior may be damaged or burned due to contact failure.
- If you directly connect the wire on the taillight or replace the bulb which is over the regulated capacity to install trailers etc., the inner junction block can get burned.
- Do not use a screwdriver or any other metal object to remove fuses because it may cause a short circuit and damage the system.

*** NOTICE**

- When replacing fuse, press the START/STOP button to the OFF position and turn off switches of all electrical devices then remove battery (-) terminal.
- The actual fuse/relay panel label may differ from equipped items.

Replacing inner panel fuse

Operation

1. Press the START/STOP button to the OFF position and turn all other switches off.
2. Open the fuse panel cover.



3. Pull the suspected fuse straight out. Use the removal tool (1) provided in

the main fuse box in the motor compartment.



4. Check the removed fuse; replace it if it is blown. Spare fuses are provided in the instrument fuse panel (or in the motor compartment fuse panel).
5. Push in a new fuse of the same rating, and make sure it fits tightly in the clips.

*** INFORMATION**

If the headlights or taillights, stoplights, day time running lights (DRL) do not work and the fuses are OK, consult a professional workshop. Kia recommends to consult an authorized Kia dealer/service partner.

Fuse switch



Operation

- Always put the fuse switch in ON position.
- If you move the switch to the OFF position, some items must be reset and the remote key may not work properly.

If the fuse switch is in OFF position, a warning sign will appear on the dash-board.

Replacing motor room fuse

Replacing blade/cartridge type fuses

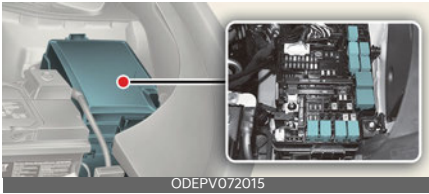

Operation

1. Turn the vehicle and all other switches off.
2. Remove the fuse panel cover by pressing the tab and pulling the cover up.

When the blade type fuse is disconnected, remove it by using the clip (1) designed for changing fuses located in the engine room fuse box. Upon removal, securely insert reserve fuse of equal quantity.



3. Check the removed fuse; replace it if it is blown. To remove or insert the fuse, use the fuse puller in the engine compartment fuse panel.
4. Push in a new fuse of the same rating, and make sure it fits tightly in the clips. If it fits loosely, consult a professional workshop. Kia recommends to

consult an authorized Kia dealer/service partner.

Replacing main/multi fuses

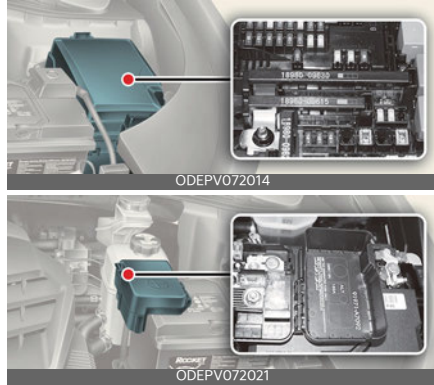

Operation

1. Turn off the vehicle.
2. Remove the fuse panel cover by pressing the tab and pulling the cover up.
3. Disconnect the negative battery cable.
4. Remove the nuts shown in the picture above.
5. Replace the fuse with a new one of the same rating.
6. Reinstall in the reverse order of removal.
7. If it fits loosely, consult a professional workshop. Kia recommends to consult an authorized Kia dealer/service partner.

Replacing relay

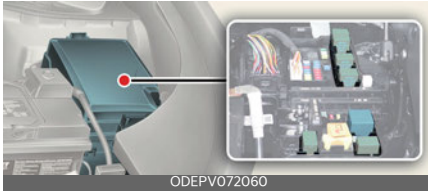

1. Turn the vehicle and all other switches off.
2. Remove the fuse panel cover by pressing the tab and pulling the cover up.
3. Replace the relay with a new one of the same rating.
4. Reinstall in the reverse order of removal.
5. If it fits loosely, consult a professional workshop. Kia recommends to consult an authorized Kia dealer/service partner.

⚠ CAUTION

- After checking the fuse panel in the engine compartment, securely install the fuse panel cover through the audible clicking sound. If not, electrical failures may occur from water contact.
- Visually inspect the battery cap for secure closing. If the battery cap is not securely latched, the electrical system may be damaged to due influx of moisture into the system.

* NOTICE

- The electronic system may not function correctly even when the engine room and internal fuse box's individual fuses are not disconnected. In such case the cause of the problem may be disconnection of the main fuse (BFT type), which is located inside the positive battery terminal (+) cap. Since the main fuse is designed more intricately than other parts, visit a professional workshop. Kia recommends to visit the nearest authorized Kia dealer/service partner.
- If the multi fuse is blown, consult a professional workshop. Kia recommends to consult an authorized Kia dealer/service partner.

Fuse/relay panel description

Inside the fuse/relay panel covers, you can find the fuse/relay label describing fuse/relay name and capacity.

* NOTICE





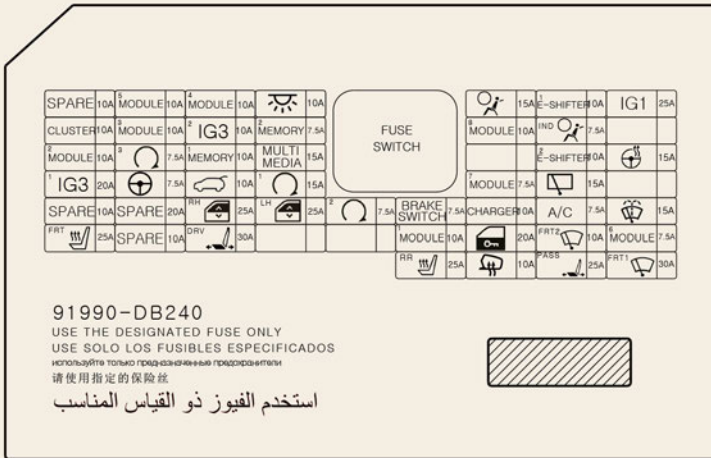







Not all fuse panel descriptions in this manual may be applicable to your vehicle. It is accurate at the time of printing. When you inspect the fuse panel in your vehicle, refer to the fuse panel label.





















Driver's side fuse panel



ODEPV072017L

ICU Junction Block

Fuse Name	Symbol	Fuse Rating	Circuit Protected
CHILD LOCK		15A	Child Lock Relay, Child Unlock Relay
MODULE 7	⁷ MODULE	7.5A	Front Seat Control Unit, Rear Seat Warmer, AC Inverter
E-SHIFTER 2	² E-SHIFTER	10A	Electronic ATM (Automatic Transmission) Shift Dial
MEMORY	MEMORY	10A	HUD, Mood Lamp, A/CON Unit, Cluster
IG3 5	⁵ IG3	10A	V2L
IG3 6	⁶ IG3	10A	BMS
IG3 7	⁷ IG3	10A	A/CON Unit, Audio/AVN Head Unit, Cluster, CDM, PM Sensor
FRONT WIPER 2	² 	10A	Front Wiper Motor
REAR WIPER		15A	Rear Wiper Relay, Rear Wiper Motor
MDPS 2	² 	7.5A	MDPS (Motor Driven Power Steering) Unit * MDPS is the same as EPS (Electric Power Steering).
IG1 2	² IG1	25A	Engine Room Junction Block (PCB BLOCK FUSE - IEB4, ECU3, DCT3, EWP3)
FCA		10A	Front Radar
START		7.5A	VCU, IBU (Integrated Body Control Unit)
HEATED MIRROR		10A	Driver/Passenger Outside Mirror Unit
TAILGATE OPEN		15A	Tailgate Latch
MODULE3	³ MODULE	7.5A	Multifunction Switch, IBU (Integrated Body Control Unit), Stop Lamp Switch, Driver Door Module
CLUSTER	CLUSTER	7.5A	Head-Up Display, Instrument Cluster
IAU	IAU	10A	Driver/Passenger Door Outside Handle
S/HEATER FRT	^{FRT} 	20A	Front Air Ventilation Seat Control Module, Front Seat Warmer Control Module
WASHER		15A	Multifunction Switch
IBU2	² IBU	7.5A	IBU (Integrated Body Control Unit)
BATTERY MAN- AGEMENT		10A	BMU
AIR BAG2	² 	10A	SRS (Supplemental Restraint System) Control Module
SUNROOF1		20A	Sunroof Motor





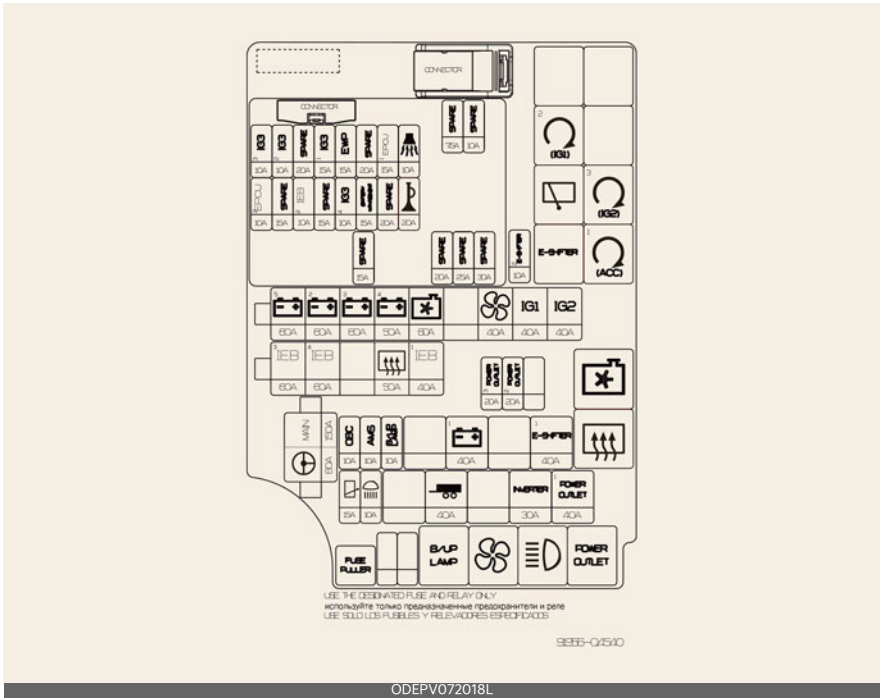





Fuse Name	Symbol	Fuse Rating	Circuit Protected
P/WINDOW LH		25A	Driver Safety Power Window Module (LHD), Passenger Safety Power Window Module (RHD), Rear Power Window Switch LH
E-SHIFTER 3		10A	Electronic ATM (Automatic Transmission) Shift Dial
MODULE4		10A	Rear Corner Radar LH/RH, Front/Rear Inverter, VESS (Virtual Engine Sound System) Unit, Front Radar, Front View Camera, ADAS Unit, Console Upper Cover Switch
USB CHARGER		10A	Driver/Passenger Seat USB Charger, Front Console USB Charger #1/#2
A/C2		15A	A/C Control Module, High Pressure Valve, Refrigerants Valve #1/#2 P/R Junction Block (Blower Relay), BSA Chiller #1, A/C Coolant Valve
AMP		30A	AMP (Amplifier)
P/WINDOW RH		25A	Passenger Safety Power Window Module (LHD), Driver Safety Power Window Module (RHD), Rear Power Window Switch RH
MODULE 6		7.5A	IBU (Integrated Body Control Unit)
MODULE 5		10A	Data Link Connector, Electro Chromic Mirror, E-CALL Unit, ADP, Audio/Video & Navigation Head Unit, Crash Pad Switch, Head Lamp LH/RH, AMP (Amplifier), Smart Phone Wireless Charger, Driver/Passenger Power Seat Module, Front Air Ventilation Seat Control Module, Front Seat Warmer Control Rear Seat Warmer Control Module, Console Floor Switch, Auto Head Lamp Leveling Device Module, IFS (Intelligent Front-Lighting System) Module
E-CALL		10A	E-CALL Unit
IBU 1		10A	IBU (Integrated Body Control Unit)
BRAKE SWITCH		10A	Stop Lamp Switch, IBU (Integrated Body Control Unit)
P/SEAT DRV		30A	Driver Power Seat Switch, Driver Power Seat Module (With IMS (Integrated memory system))
A/C1		7.5A	A/C Control Module
AIR BAG 1		15A	SRS (Supplemental Restraint System) Control Module
MODULE 2		10A	AMP (Amplifier), ADP, P/E Junction Block (Power Outlet Relay), IBU (Integrated Body Control Unit), E-CALL Unit, ADAS Unit, Audio/Video & Navigation Keyboard, Audio/Video & Navigation Head Unit
MULTIMEDIA		25A	Audio/Video & Navigation Head Unit
DOOR LOCK		20A	Door Lock Relay, Door Unlock Relay, Dead Lock Relay
MODULE 1		10A	Hazard Lamp Switch, Multifunction Switch, Data Link Connector, Rain Sensor, UIP Siren, UIP Sensor, PTG Unit, Driver Door Module, Driver/Passenger Outside Mirror Unit
P/SEAT PASS		30A	Passenger Power Seat Switch, Passenger Power Seat Module
S/HEATER RR		25A	Rear Seat Warmer Control Module

Motor compartment fuse panel













Circuit (P/R Junction Block)

	Fuse Name	Symbol	Fuse Rating	Circuit Protected
MULTI FUSE-1	LDC	LDC	150A	Fuse (IEM, EOP, Inverter, Power Outlet)
	MDPS1	1	80A	MDPS Unit * MDPS is the same as EPS (Electric Power Steering).
MULTI FUSE-3	B+5	5	60A	PCB Block (IG3 Main Relay, Fuse: WIPER1, EPCU1, B/ALARM, HORN, VCU2)
	IG1	1	40A	(FUSE -MODULE2, USB CHARGER, A/BAG1, IBU2, MDPS2, CLUSTER, MODULE3, A/BAG IND, MODULE4, MODULE5, E-SHIFTER2, FCA, ING1 2)
	B+1	1	60A	ICU Junction Block (PS2, IPS3, IPS5, IPS7, IPS12, IPS14)
	IEB 1	1	60A	IEB Unit
	IEB 3	3	60A	IEB Unit
	IG1	1	50A	Trailer Connector Unit
	BLOWER		40A	Engine Room Junction Block (Blower Relay)
MULTI FUSE-2	C/FAN		80A	Cooling Fan Motor
	RR HTD		40A	P/R Junction Block (Rear Heated Relay)
	B+2	2	60A	ICU Junction Block (IPS)
	B+3	3	50A	ICU JUNCTION BLOCK (FUSE - CHILD LOCK , E-SHIFTER3, P/WDW LH, P/WDW RH, T/GATE OPEN, AMP, P/SEAT DRV, P/SEAT PASS, S/HEATER FRT, S/HEATER RR), EWP2
	POWER TAIL-GATE		40A	Power Tailgate Unit
	IG2	IG2	40A	ICU JUNCTION BLOCK (FUSE - WASHER, A/C, MODULE6, MODULE7, WIPER RR)
	E-SHIFTER 1	1	40A	SCU







Fuse Name	Symbol	Fuse Rating	Circuit Protected	
FUSE	B+4	⁴ 	40A	ICU Junction Block (Long Term Load Latch Relay, Fuse: !AU, ECS, BATTERY MANAGEMENT, AIR BAG2, MEMORY1, SPARE3 (B+), A/C2, E-CALL, IBU1, BRAKE SWITCH, MULTIMEDIA, DOOR LOCK, MODULE1)
	IEB 2	² 	40A	IEB Unit
	CHARGER 1	¹ 	10A	CDM
	EWP1	¹ 	20A	Electronic Water Pump #1
	EWP2	² 	20A	Electronic Water Pump #2
	P/OUTLET1	¹ 	40A	Power Outlet Relay
	INVERTER		40A	Rear Electronic Oil Pump
	EOP		40A	Front Electronic Oil Pump
	E-SHIFTER2	² 	10A	E-Shifter Relay, SCU, Electronic ATM Shift Dial
	P/OUTLET2	² 	20A	Front Power Outlet

PCB Block

Fuse Name	Symbol	Fuse Rating	Circuit Protected
WIPER1	¹ 	25A	PCB (Printed Circuit Board) Block (Wiper Main Relay)
EPCU		15A	Front Inverter
B/ALARM		15A	PCB (Printed Circuit Board) Block (Burglar Alarm Horn Relay)
HORN		15A	PCB (Printed Circuit Board) Block (Horn Relay)
OBC		10A	ICCU, VCMS
EWP 3	³ 	15A	EWP PE
IG3 1	¹ 	15A	Inverter, VCU
IG3 3	³ 	20A	Electronic Water Pump
EPCU	^{E2} 	15A	Inverter
ECU 1	^{E1} 	10A	VCU
IG3 4	⁴ 	15A	ICCU, VCMS, CDM, Cooling Fan
IEB 4	⁴	10A	IEB Unit
CHARGER 2	²	10A	Charger Lock, Unlock Relay
IG3 2	²	20A	3WAY V/V, EOP, ICU (IG3 FUSE)

Relay

Refer to the following table for the relay type.

Relay Name	Symbol	TYPE
Rear Heated Relay		MINI
ACC Relay		MICRO
IG1 Relay		MICRO
Blower Relay		MICRO
IG2 Relay		MICRO
Power Outlet Relay	POWER OUTLET	MICRO
REAR WIPER RELAY		MICRO

Engine compartment fuse panel (Battery terminal cover)

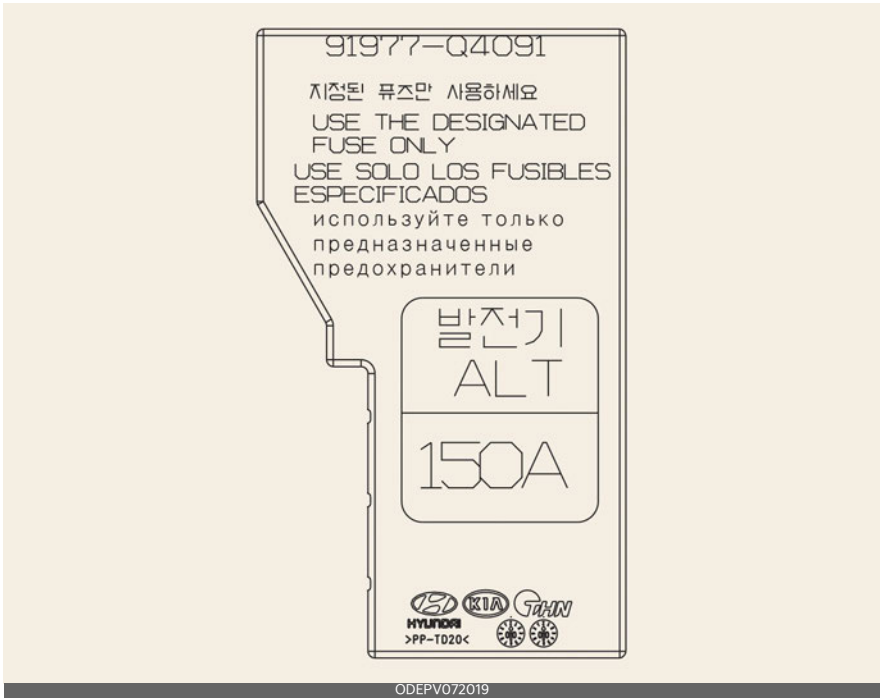
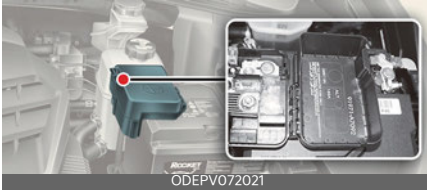

Lamps

Bulb replacement precautions

Turn off the vehicle at a safe place, firmly apply the side brake and take out the battery's negative (-) terminal. Use only the bulbs of the specified wattage.

Lamp part malfunction due to network failure

Lamp part malfunction may be caused by network failure or vehicle electrical control system malfunction. If there is a problem, have the system serviced by a professional workshop. Kia recommends to visit an authorized Kia dealer/service partner.

Lamp part malfunction due to electrical control system stabilization

A normally functioning lamp may flicker momentarily. This momentary occurrence is due to stabilization unction of the vehicle's electrical on control system. If the lamp soon returns to normal, the vehicle does not require service.

However, if the lamp goes out after the momentary flickering, or the flickering continues, have the system serviced by a professional workshop. Kia recommends to visit an authorized Kia dealer/service partner.

WARNING

- Prior to working on the light, firmly apply the parking brake, press the START/STOP button to the OFF position and turn off the lights to avoid sudden movement of the vehicle and burning your fingers or receiving an electric shock.
- Be sure to replace the burned out bulb with one of the same wattage rating. Otherwise, it may cause extensive wiring damage and possible fire.
 - Be aware the bulbs may be hot and may burn your fingers.

CAUTION

- If you don't have necessary tools, the correct bulbs and the expertise, consult a professional workshop. Kia recommends to consult an authorized Kia dealer/service partner.
- In many cases, it is difficult to replace vehicle light bulbs because other parts of the vehicle must be removed before you can get to the bulb. This is especially true if you have to remove the headlight assembly to get to the bulb(s). Removing/installing the headlight assembly can result in damage to the vehicle.
- If unauthentic parts or substandard lights are used when changing lights, it may lead to fuse disconnection and malfunction, and other wiring damages.

- Do not install extra lamps or LED to the vehicle. If supplementary lights are installed, it may lead to lamp malfunction and flickering of the lights. In addition, the fuse box and other wiring may be damaged.
- After driving in heavy rain or washing, headlamp and taillamp lenses could appear frosty. This condition is caused by the temperature difference between the lamp inside and outside. This is similar to the condensation on your windows inside your vehicle during the rain and doesn't indicate a problem with your vehicle. If the water leaks into the lamp bulb circuitry, have the vehicle checked by a professional workshop. Kia recommends to visit an authorized Kia dealer/service partner.

* NOTICE

- If the light bulb or lamp connector is removed from an operating lamp activated by electricity, the fuse box's electronic device may scan it as a malfunction. Therefore, a lamp malfunction history may be recorded in Diagnostic Trouble Code (DTC) in the fuse box.
- It is normal for an operating lamp may blink temporarily. Since this occurrence is due stabilization function of the vehicle's electronic control device, if the lamp lights up normally after temporary blinking, there is no problem in the vehicle.
However, if the lamp continues to blink several times or turn off completely, there may be an error in the vehicle's electronic control device. In this case, have the vehicle checked by a professional workshop immediately. Kia recommends to visit an authorized Kia dealer/service partner.
- After an accident or after the headlight assembly is reinstalled, have the headlight aiming adjusted by a professional workshop. Kia recommends to visit an authorized Kia dealer/service partner.

* NOTICE

Traffic Change (For Europe)

The low beam light distribution is asymmetric. If you go abroad to a country with opposite traffic direction, this asymmetric part will dazzle oncoming car driver. To prevent dazzle, ECE regulation demand several technical solutions (ex. automatic change system, adhesive sheet, down aiming). This headlamps are designed not to dazzle opposite drivers. So, you need not change your headlamps in a country with opposite traffic direction.

Light position (Front)

Head lamp (Type A)



Head lamp (Type B)



Day time running lamp/Position lamp



- 1 Headlamp (Low/High) (Bulb type)
- 2 Front turn signal lamp (Bulb type)
- 3 Headlamp (Low/High) (LED type)
- 4 Headlamp (Low) (LED type)
- 5 Front turn signal lamp (LED type)
- 6 Day time running lamp/Position lamp (LED type)

Light position (Rear)

Rear combination lamp - Type A



Rear combination lamp - Type B

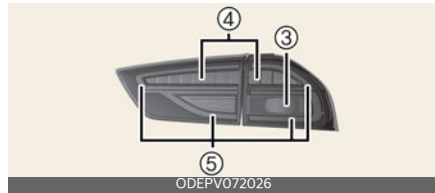

Backup lamp/Rear fog lamp



High mounted stop lamp/License plate lamp

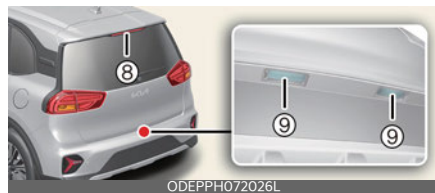

- 1 Tail lamp/Stop lamp (Bulb type)
- 2 Tail lamp (Bulb type)
- 3 Rear turn signal lamp (Bulb type)
- 4 Stop lamp (LED type)
- 5 Tail lamp (LED type)
- 6 Backup lamp (Bulb type)
- 7 Rear fog lamp (LED type, Left-hand drive)
- 8 High mounted stop lamp (LED type)
- 9 License plate lamp (LED type)

- 7 Backup lamp (Bulb type)
Rear fog lamp (LED type, Right-hand drive)
- 8 High mounted stop lamp (LED type)
- 9 License plate lamp (Bulb type)

Light position (Side) (if equipped)



- 1 Side repeater lamp (LED type)

Replacing lights (LED type)

If the LED lamp does not operate, have your vehicle checked by a professional workshop. Kia recommends to visit an authorized Kia dealer/service partner.

The LED lamp cannot be replaced as a single unit because it is an integrated unit. The LED lamp has to be replaced with the unit.

A skilled technician should check or repair the LED lamp, for it may damage related parts of the vehicle.

Replacing headlamp (Low beam/ High beam) (Bulb type)

Operation

1. Turn off vehicle and disconnect the negative terminal from the battery.
2. Open the hood.
3. Remove the headlamp bulb cover by turning it counterclockwise.

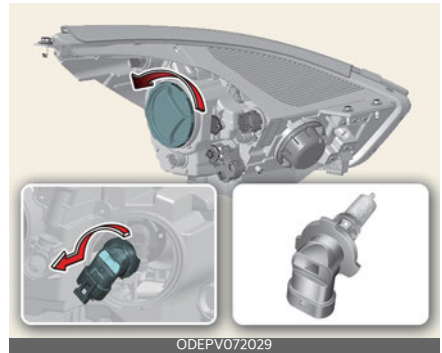

4. Disconnect the headlamp bulb socket connector.
5. Remove the bulb socket from the headlamp assembly by turning the bulb socket counterclockwise until the tabs on the bulb socket align with the slots on the headlamp assembly.
6. Install a new bulb socket assembly in the headlamp assembly by aligning the tabs on the bulb socket with the slots in the headlamp assembly. Push the bulb socket into the headlamp assembly and turn the bulb socket clockwise.
7. Install the headlamp bulb cover by turning it clockwise.
8. Connect the negative terminal from the battery.

⚠ WARNING

- Halogen bulbs contain pressurized gas that will produce flying pieces of glass if broken.
- Always handle them carefully, and avoid scratches and abrasions. If the bulbs are lit, avoid contact with liquids. Never touch the glass with bare hands. Residual oil may cause the bulb to overheat and burst when lit. A bulb should be operated only when installed in a headlight.



- If a bulb becomes damaged or cracked, replace it immediately and carefully dispose of it.
- Wear eye protection when changing a bulb. Allow the bulb to cool down before handling it.

Replacing front turn signal lamp (Bulb type)

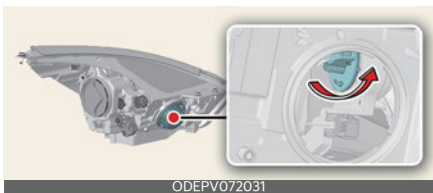

Operation

1. Turn off vehicle and disconnect the negative terminal from the battery.
2. Open the hood.

3. Remove the dust cover (A) from the headlamp assembly then bulb socket by turning the counterclockwise until the tabs on the bulb socket align with the slots on the headlamp assembly.
4. Remove the bulb from the bulb socket by pressing it in and rotating it counterclockwise until the tabs on the bulb align with the slots in the bulb socket. Pull the bulb out of the bulb socket.
5. Insert a new bulb by inserting it into the bulb socket and rotating it until it locks into place.
6. Install the socket in the headlamp assembly by aligning the tabs on the bulb socket with the slots in the assembly. Push the bulb socket into the headlamp assembly and turn the socket clockwise.
7. Connect the negative terminal from the battery.

Replacing rear tail lamp, stop lamp, rear turn signal lamp (Bulb type)

Operation

1. Open the tailgate.
2. Open the service cover.
3. Loosen the light assembly retaining screws with a cross-tip screw driver.



4. Remove the rear combination lamp assembly from the body of the vehicle.



5. Disconnect the rear combination lamp connector.
6. Remove the socket from the assembly by turning the socket counterclockwise until the tabs on the socket align with the slots on the assembly.

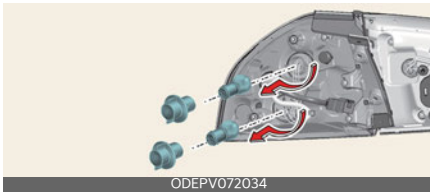

7. Remove the bulb from the socket by pressing it in and rotating it counterclockwise until the tabs on the bulb align with the slots in the socket. Pull the bulb out of the socket.
8. Insert a new bulb by inserting it into the socket and rotating it until it locks into place.
9. Install the socket in the assembly by aligning the tabs on the socket with the slots in the assembly. Push the socket into the assembly and turn the socket clockwise.
10. Install the rear combination lamp assembly to the body of the vehicle.
11. Install the service cover.

Replacing rear tail lamp (Bulb type)

Operation

1. Open the tailgate.
2. Remove the service cover.



3. Remove the socket from the assembly by turning the socket counterclockwise until the tabs on the socket align with the slots on the assembly.

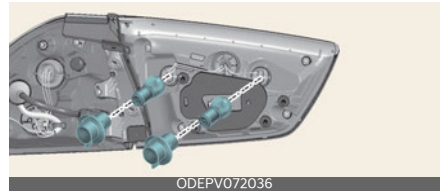

4. Remove the bulb from the socket by pressing it in and rotating it counterclockwise until the tabs on the bulb align with the slots in the socket. Pull the bulb out of the socket.
5. Insert a new bulb by inserting it into the socket and rotating it until it locks into place.
6. Install the socket in the assembly by aligning the tabs on the socket with the slots in the assembly. Push the socket into the assembly and turn the socket clockwise.
7. Install the rear combination lamp assembly to the body of the vehicle.
8. Install the service cover.

Replacing rear backup lamp (Bulb type)



If the rear backup lamp (1) does not operate, have your vehicle checked by a professional workshop. Kia recommends to visit an authorized Kia dealer/service partner.

Replacing rear fog lamp (LED type)



If the rear fog lamp (1) does not operate, have your vehicle checked by a professional workshop. Kia recommends to visit an authorized Kia dealer/service partner.

Replacing license plate lamp (Bulb type)



Operation

1. Turn off vehicle and disconnect the negative terminal from the battery.

2. Using a screwdriver, gently pry the lamp assembly.
3. Remove the bulb by pulling it straight out.
4. Install a new bulb in the socket.
5. Install the lamp assembly.

⚠ CAUTION

Be careful not to dirty or damage the lens, lens tab, and plastic housings.

Replacing map lamp (Bulb type)



Operation

1. Using a flat-blade screwdriver, gently pry the lens cover from lamp housing.
2. Remove the bulb by pulling it straight out.
3. Install a new bulb in the socket.
4. Align the lens cover tabs with the lamp housing notches and snap the lens into place.

⚠ WARNING

Prior to working on the Interior lamps, ensure that the "OFF" button is depressed to avoid burning your fingers or receiving an electric shock.

Replacing vanity mirror lamp (Bulb type)



Operation

1. Using a flat-blade screwdriver, gently pry the lens cover from lamp housing.
2. Remove the bulb by pulling it straight out.
3. Install a new bulb in the socket.
4. Align the lens cover tabs with the lamp housing notches and snap the lens into place.

⚠ WARNING

Prior to working on the Interior lamps, ensure that the "OFF" button is depressed to avoid burning your fingers or receiving an electric shock.

Replacing room lamp (Bulb type)



Operation

1. Using a flat-blade screwdriver, gently pry the lens cover from lamp housing.
2. Remove the bulb by pulling it straight out.
3. Install a new bulb in the socket.

4. Align the lens cover tabs with the lamp housing notches and snap the lens into place.

⚠ WARNING

Prior to working on the Interior lamps, ensure that the "OFF" button is depressed to avoid burning your fingers or receiving an electric shock.

Replacing luggage lamp (Bulb type)



Operation

1. Using a flat-blade screwdriver, gently pry the lens cover from lamp housing.
2. Remove the bulb by pulling it straight out.
3. Install a new bulb in the socket.
4. Align the lens cover tabs with the lamp housing notches and snap the lens into place.

⚠ WARNING

Prior to working on the Interior lamps, ensure that the "OFF" button is depressed to avoid burning your fingers or receiving an electric shock.

Appearance care

Exterior care

Exterior general caution

Read all warning and caution statements that appear on the label and follow the label directions when using any chemical cleaner or polish.

* NOTICE

If you park the vehicle around a stainless signboard or windshield building etc., the plastic exterior trim (bumper, spoiler, garnish, lamp, outside mirror etc.) may be damaged by reflected sunlight from the external structure. To avoid damaging the plastic exterior trim, park the vehicle away from the areas where the reflected light may occur or use a vehicle cover. (Depending on the vehicle, the type of exterior trim applied such as spoiler may differ.)

Finish maintenance

Washing

To help protect your vehicle's finish from rust and deterioration, wash it thoroughly and frequently at least once a month with lukewarm or cold water.

If you use your vehicle for off-road driving, you should wash it after each off-road trip. Pay special attention to the removal of any accumulation of salt, dirt, mud, and other foreign materials. Make sure the drain holes in the lower edges of the doors and rocker panels are kept clear and clean. Insects, tar, tree sap, bird droppings, industrial pollution and similar deposits can damage your vehicle's finish if not removed immediately.

Even prompt washing with plain water may not completely remove all these deposits. A mild soap, safe for use on painted surfaces, may be used. After washing, rinse the vehicle thoroughly with lukewarm or cold water. Do not allow soap to dry on the finish.

⚠ WARNING

After washing the vehicle, test the brakes while driving slowly to see if they have been affected by water. If braking performance is impaired, dry the brakes by applying them lightly while maintaining a slow forward speed.

⚠ CAUTION

- Do not use strong soap, chemical detergents or hot water, and do not wash the vehicle in direct sunlight or when the body of the vehicle is warm.
- Be careful when washing the side windows and other gaps (between door and body structure, side windows and exterior) of your vehicle. Especially, with high-pressure water, water may leak through the windows and wet the interior.
- To prevent damage to the plastic parts and lamps, do not clean with chemical solvents or strong detergents.

High-pressure washing



- When using high-pressure washers, make sure to maintain sufficient distance from the vehicle. Insufficient clearance or excessive pressure can lead to component damage or water penetration.
- Do not spray the camera, sensors or its surrounding area directly with a high pressure washer. Shock applied from high pressure water may cause the device to not operate normally.
- Do not bring the nozzle tip close to boots (rubber including weather strips or plastic covers) or connectors as they may be damaged if they come into contact with high pressure water.

⚠ CAUTION

- Water washing in the motor compartment including high pressure water washing may cause the failure of electrical circuits located in the motor compartment.
- Never allow water or other liquids to come in contact with electrical/electronic components inside the vehicle as this may damage them.

Waxing

Wax the vehicle when water will no longer bead on the paint.

Always wash and dry the vehicle before waxing. Use a good quality liquid or paste wax, and follow the manufacturer's instructions. Wax all metal trim to protect it and to maintain its luster.

Removing oil, tar, and similar materials with a spot remover will usually strip the wax from the finish. Be sure to re-wax these areas even if the rest of the vehicle does not yet need waxing. Do not apply wax on embossed unpainted unit, as it may tarnish the unit.

⚠ CAUTION

- Wiping dust or dirt off the body with a dry cloth will scratch the finish.
- Do not use steel wool, abrasive cleaners, acid detergents or strong detergents containing high alkaline or caustic agents on chrome-plated or anodized aluminum parts. This may result in damage to the protective coating and cause discoloration or paint deterioration.

Finish damage repair

Deep scratches or stone chips in the painted surface must be repaired promptly. Exposed metal will quickly rust and may develop into a major repair expense.

* NOTICE

If your vehicle is damaged and requires any metal repair or replacement, be sure the body shop applies anti-corrosion materials to the parts repaired or replaced.

Bright-metal maintenance

- To remove road tar and insects, use a tar remover, not a scraper or other sharp object.
- To protect the surfaces of bright metal parts from corrosion, apply a coating of wax or chrome preservative and rub to a high luster.
- During winter weather or in coastal areas, cover the bright metal parts with a heavier coating of wax or preservative. If necessary, coat the parts with non-corrosive petroleum jelly or other protective compound.

Underbody maintenance

Corrosive materials used for ice and snow removal and dust control may collect on the underbody. If these materials are not removed, accelerated rusting can occur on underbody parts such as the frame, floor pan, even though they have been treated with rust protection.

Thoroughly flush the vehicle underbody and wheel openings with lukewarm or cold water once a month, after off-road driving and at the end of each winter.

Pay special attention to these areas because it is difficult to see all the mud and dirt. It will do more harm than good to wet down the road grime without removing it. The lower edges of the doors, rocker panels, and frame members have drain holes that should not clog with dirt; trapped water in these areas can cause rusting.

WARNING

After washing the vehicle, test the brakes while driving slowly to see if they have been affected by water. If braking performance is impaired, dry the brakes

by applying them lightly while maintaining a slow forward speed.

Aluminum wheel maintenance

The aluminum wheels are coated with a clear protective finish.

- Do not use any abrasive cleaner, polishing compound, solvent, or wire brushes on aluminum wheels. They may scratch or damage the finish.
- Clean the wheel when it has cooled.
- Use only a mild soap or neutral detergent, and rinse thoroughly with water. Also, be sure to clean the wheels after driving on salted roads. This helps prevent corrosion.
- Avoid washing the wheels with high-speed car wash brushes.
- Do not use any alkaline or acid detergent. It may damage and corrode the aluminum wheels coated with a clear protective finish.

Corrosion protection

Protecting your vehicle from corrosion

By using the most advanced design and construction practices to combat corrosion, we produce vehicles of the highest quality. However, this is only part of the job. To achieve the longterm corrosion resistance your vehicle can deliver, the owner's cooperation and assistance is also required.

Common causes of corrosion

The most common causes of corrosion on your vehicle are:

- Road salt, dirt and moisture that is allowed to accumulate underneath the vehicle.
- Removal of paint or protective coatings by stones, gravel, abrasion or minor scrapes and dents which leave unprotected metal exposed to corrosion.

High-corrosion areas

If you live in an area where your vehicle is regularly exposed to corrosive materials, corrosion protection is particularly important. Some of the common causes of accelerated corrosion are road salts, dust control chemicals, ocean air and industrial pollution.

Moisture breeds corrosion

Moisture creates the conditions in which corrosion is most likely to occur. For example, corrosion is accelerated by high humidity, particularly when temperatures are just above freezing. In such conditions, the corrosive material is kept in contact with the vehicle's surface by moisture that evaporate slowly. Mud is particularly corrosive because it dries slowly and holds moisture in contact with the vehicle. Although the mud appears to be dry, it can still retain moisture and promote corrosion. High temperatures can also accelerate corrosion of parts that are not properly ventilated so the moisture can be dispersed.

Keep your vehicle clean and free of mud or accumulations of other materials. This applies not only to the visible surfaces but particularly to the underside of the vehicle.

To help prevent corrosion

You can help prevent corrosion from getting started by observing the following:

Keep your vehicle clean

The best way to prevent corrosion is to keep your vehicle clean and free of corrosive materials. Attention to the underside of the vehicle is particularly important.

- If you live in a high-corrosion area - where road salts are used, near the ocean, areas with industrial pollution, acid rain, etc., you should take extra care to prevent corrosion. In winter, hose off the underside of your vehicle at least once a month and be sure to clean the underside thoroughly when winter is over.
- When cleaning underneath the vehicle, give particular attention to the components under the fenders and other areas that are hidden from view. Do a thorough job; just dampening the accumulated mud rather than washing it away will accelerate corrosion rather than prevent it. Water under high pressure and steam are particularly effective in removing accumulated mud and corrosive materials.
- When cleaning lower door panels, rocker panels and frame members, be sure that drain holes are kept open so that moisture can escape and not be trapped inside to accelerate corrosion.

Keep your garage dry

Don't park your vehicle in a damp, poorly ventilated garage. This creates a favorable environment for corrosion.

This is particularly true if you wash your vehicle in the garage or drive it into the garage when it is still wet or covered with snow, ice or mud. Even a heated garage can contribute to corrosion unless it is well ventilated so moisture is dispersed.

Keep paint and trim in good condition

Scratches or chips in the finish should be covered with "touch-up" paint as soon as possible to reduce the possibility of corrosion. If bare metal is showing through, the attention of a qualified body and paint shop is recommended.

Bird droppings are highly corrosive and may damage painted surfaces in just a few hours. Always remove bird droppings as soon as possible.

Don't neglect the interior

Moisture can collect under the floor mats and carpeting and cause corrosion. Check under the mats periodically to be sure the carpeting is dry. Use particular care if you carry fertilizers, cleaning materials or chemicals in the vehicle.

These should be carried only in proper containers and any spills or leaks should be cleaned up, flushed with clean water and thoroughly dried.

Interior care

Interior general precautions

* NOTICE

Prevent chemicals such as perfume, cosmetic oil, sun cream, hand cleaner, and air freshener from contacting the interior parts because they may cause damage or discoloration. If they do contact the interior parts, wipe them off immediately. If necessary, use a mixture of warm water and mild non-detergent cleaner (test all cleaners on a concealed area before use). Use proper car cleaner to clean interior parts.

▲ CAUTION

- Never allow water or other liquids to come in contact with electrical/electronic components inside the vehicle as this may damage them.
- When cleaning leather products (steering wheel, seats etc.), use neutral detergents or low alcohol content solutions. If you use high alcohol content solutions or acid/alkaline detergents, the color of the leather may fade or the surface may get stripped off.

Taking care of leather seats (if equipped)

- Vacuum the seat periodically to remove dust and sand on the seat. It will prevent abrasion or damage of the leather and maintain its quality.
- Wipe the leather seat cover often with dry or soft cloth.
- Sufficient use of a leather protective may prevent abrasion of the cover and helps maintain the color. Be sure to read the instructions and consult a specialist when using leather coating or protective agents.
- Leather with bright colors is easily contaminated and clear in appearance. Clean the seats frequently.
- Avoid wiping with wet cloth. It may cause the surface to crack.

Cleaning the leather seats (if equipped)

- Remove all contaminations instantly. Refer to instructions below for removal of each contaminant.
- Cosmetic products
 - Apply cleansing cream on a cloth and wipe the contaminated point. Wipe off the cream with a wet cloth and remove water with a dry cloth.
- Beverages
 - Apply a small amount of neutral detergent and wipe until contaminations do not smear.
- Oil
 - Remove oil instantly with absorbable cloth and wipe with stain remover for leather only.
- Chewing gum
 - Harden the gum with ice and remove gradually.

Fabric seat cover using precautions (if equipped)

Clean the fabric seats regularly with a vacuum cleaner in consideration of fabric material characteristics. If they are heavily soiled with beverage stains, etc., use a suitable interior cleaner. To prevent damage to seat covers, wipe off the seat covers down to the seams with a large wiping motion and moderate pressure using a soft sponge or microfiber cloth.

Velcro closures on clothing or sharp objects may cause snagging or scratches on the surface of the seats. Make sure not to rub such objects against the surface.

Cleaning the upholstery and interior trim

Car interior surfaces

Remove dust and loose dirt from interior surfaces with a whisk broom or a vacuum cleaner. If necessary, clean interior surfaces with a mixture of warm water and mild non-detergent cleaner (test all cleaners on a concealed area before use).

Fabric

Remove dust and loose dirt from fabric with a whisk broom or vacuum cleaner. Clean with a mild soap solution recommended for upholstery or carpets. Remove fresh spots immediately with a fabric spot cleaner. If fresh spots do not receive immediate attention, the fabric can be stained and its color can be affected. Also, its fire-resistant properties can be reduced if the material is not properly maintained.

⚠ CAUTION

Using anything but recommended cleaners and procedures may affect the fabric's appearance and fire-resistant properties.

Cleaning the lap/shoulder belt webbing

Clean the belt webbing with any mild soap solution recommended for cleaning upholstery or carpet. Follow the instructions provided with the soap. Do not bleach or re-dye the webbing because this may weaken it.

Cleaning the interior window glass

If the interior glass surfaces of the vehicle become fogged (that is, covered with an oily, greasy or waxy film), they should be cleaned with a glass cleaner. Follow the directions on the glass cleaner container.

⚠ CAUTION

Do not scrape or scratch the inside of the rear window. This may result in damage of the rear window defroster grid.

Dimensions	9-2
Electric vehicle specifications	9-2
Volume and weight	9-3
Air conditioning system.....	9-3
Bulb wattage	9-4
Tires and wheels	9-5
Recommended lubricants and capacities	9-6
Vehicle Identification Number (VIN).....	9-7
Vehicle certification label.....	9-7
Tire specification and pressure label.....	9-7
Motor number	9-7
Air conditioner compressor label	9-8
Refrigerant label.....	9-8
Declaration of conformity	9-8
How to check the symbol on the charging label (For Europe)	9-9

Specifications & Consumer information

Dimensions

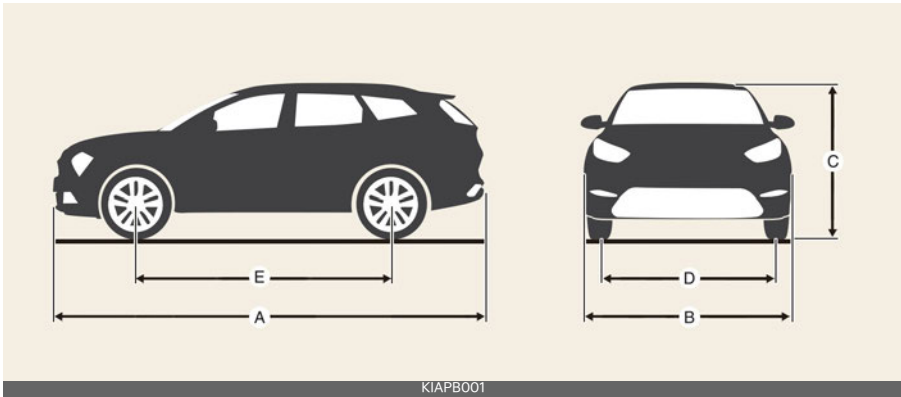

Item		mm (inches)	
A	Overall length	4,385 (172.6)	
B	Overall width	1,805 (71.1)	
C	Overall height	Without antenna	1,640 (64.6)
		With antenna	1,675 (65.9)
D	Front	215/55 R17	1,562 (61.5)
	Rear	215/55 R17	1,572 (61.9)
E	Wheelbase	2,700 (106.3)	

Electric vehicle specifications

OBC: On-Board Battery Chargers

Items		Extended type	
		2WD	
Motor	Max. output (kW)	150	
	Max. torque (Nm)	395	
Battery (Lithium-ion)	Capacity (kWh)	64.0	
	Power output (kW)	170	
	Voltage (V)	356	
Charger (OBC)	Max. output (kW)	AC single phase	72 kW
		AC 3 phase	11 kW

Volume and weight

Gross Vehicle Weight	Luggage Volume VDA [L (cu ft)]	
	Min.	Max.
2,230 kg (4,916 lbs.)	397 (14)	1,497 (52.9)

Air conditioning system

Please contact a professional workshop for more details. Kia recommends to contact an authorized Kia dealer/service partner.

Item		Weight of volume (g)	Classification	
Refrigerant	Type A	With heat pump	1,000±25	R-134a
		Without heat pump	650±25	R-134a
	Type B	With heat pump	1,000±25	R-1234yf
		Without heat pump	650±25	R-1234yf
Compressor lubricant		180±10	POE	

Bulb wattage

*: if equipped

	Light bulb	Bulb type	Wattage (Watt)
Head lamp (Type A)*	Head lamp (High/Low)	HB3	60
	Turn signal lamps	PY21W	21
Head lamp (Type B)*	Head lamp (Low)	LED	LED
	Head lamp (High/Low)	LED	LED
	Turn signal lamps	LED	LED
Front and side	Position lamps/daytime running lamps	LED	LED
	Side repeater lamps (LED type)	LED	LED
Rear combination lamp (Type A)*	Stop lamp/tail lamps	P21/5W	21/5
	Tail lamps	W5W	5
	Turn signal lamps	PY21W	21
Rear combination lamp (Type B)*	Stop lamps	LED	LED
	Tail lamps	LED	LED
	Turn signal lamps	P21WLL	21
Rear	High mounted stop lamp	LED	LED
	Backup lamps	P21W	21
	License plate lamps	W5W	5
	Rear fog lamp*	LED	LED
Interior	Map lamps (Bulb type)	WEDGE (W10W)	10
	Room lamps (Bulb type)	FESTOON	10
	Vanity mirror lamps*	FESTOON	5
	Luggage lamp (Bulb type)	FESTOON	10
	Ambient light	LED	LED

Tires and wheels

*1. Load Index

*2. Speed Symbol

Item	Tire size	Wheel size	Load capacity		Speed capacity		Inflation pressure [bar (psi, kPa)]				Wheel lug nut torque kgf·m (lbf·ft, N·m)
			L ^{*1}	kg	SS ^{*2}	km/h	Normal load		Maximum load		
							Front	Rear	Front	Rear	
Full size tire	215/55 R17	7.0Jx17	94	670	V	240	2.5 (36, 250)				11~13 (79~94, 107~127)

⚠ CAUTION

When replacing tires, use the same size originally supplied with the vehicle. Using tires of a different size can damage the related parts or make it work irregularly.

*** NOTICE**

- We recommend that when replacing tires, use the same originally supplied with the vehicles. If not, that affects driving performance.
- When driving in high altitude grades, it is natural for the atmospheric pressure to decrease. Therefore, please check the tire pressure and add more air when necessary.
 - Additionally required tire air pressure per km above sea level: 1.5 psi/km

Recommended lubricants and capacities

To help achieve proper vehicle performance and durability, use only lubricants of the proper quality. These lubricants and fluids are recommended for use in your vehicle.

Lubricant		Volume (L)	Classification
Reduction gear fluid		Approx. 1.0 ~1.1	SAE 70W, API GL-4 HK SYN MTF 70W (SK), SPIRAX S6 GHME 70W MTF (H.K.SHELL), GS MTF HD 70W (GS CAL-TEX), Kia genuine MTF&DCTF 70W SYNTHETIC
Brake fluid		As required	SAE J1704 DOT-4 LV, FMVSS 116 DOT-4, ISO4925 CLASS-6
Coolant	Without heat pump	12.5~13	Designated coolant water for electric vehicles.
	With heat pump	13~13.4	

Vehicle Identification Number (VIN)

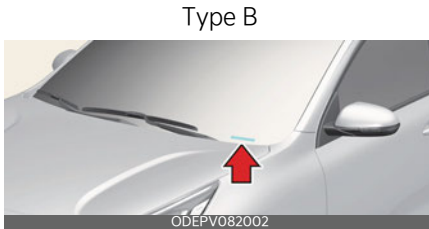

The Vehicle Identification Number (VIN) is the number used in registering your vehicle and in all legal matters pertaining to its ownership, etc.

- Type A: Engraved on the floor under the front left or right seat. Open the cover to check the VIN.
- Type B: Written on a plate attached to the top left or top right of the dashboard through the front windshield.

Vehicle certification label



The vehicle certification label attached on the center pillar as shown gives the vehicle identification number (VIN).

Tire specification and pressure label

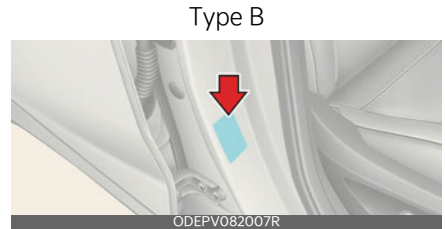
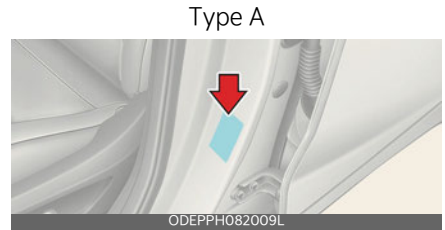

The tire label located on the center pillar as shown gives the tire pressures recommended for your vehicle. The tires supplied on your new vehicle are chosen to provide the best performance for normal driving.

Motor number

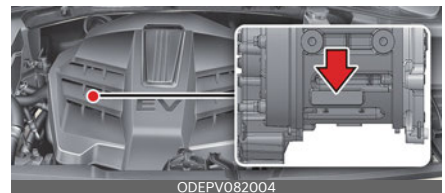

The motor number is stamped on the motor as shown.

Air conditioner compressor label

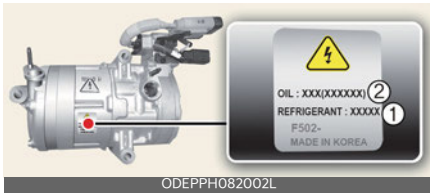

- 1 Refrigerant
- 2 Refrigerant oil

A compressor label informs you the type of compressor your vehicle is equipped with such as model, supplier part number, production number, refrigerant (1) and refrigerant oil (2).

Refrigerant label



The refrigerant label is located as shown.

Declaration of conformity





CE CE 0678





The radio frequency components of the vehicle comply with requirements and other relevant provisions of Directive 1995/5/EC.

Further information including the manufacturer's declaration of conformity is available on Kia website as follows:

<http://www.kia-hotline.com>

How to check the symbol on the charging label (For Europe) (if equipped)

Vehicle charging INLET	Charging connector OUTLET
 <p>ODEPVQ012090L</p>	<p>Type A</p>  <p>ODEPPH082006L</p>
 <p>ODEPV082005L</p>	<p>Type B</p>  <p>OCVQ011016L</p>  <p><Symbol location and application example></p>

Vehicle charging INLET	Charging connector OUTLET
 <p>ODEPVQ012090</p>	 <p>ODEPPH082006L</p>
 <p>OCV081009L</p>	 <p><Symbol location and application example></p>

Precautions for charging AC and Trickle charger (Portable charging cable) (AC charging)

1. After opening the charging door, check the charging symbol at the bottom of the warning label.
2. Check the charging connector symbol of the AC and Trickle charger cable.
3. After checking the alphabet letter of the charging symbol, proceed the charging step.
* Refer to "Electric charging label symbol table (For Europe)" on page 9-12.
4. Risk of failure, fire, injury, etc. expected when using the charging connector with unmatched symbol.

Precautions for DC charging (DC charging)

1. After opening the charging door, check the charging symbol at the bottom of the warning label.
2. Check the charging connector symbol at the high speed charging station.
3. After checking the alphabet letter of the charging symbol, proceed the charging step.
* Refer to "Electric charging label symbol table (For Europe)" on page 9-12.
4. Risk of failure, fire, injury, etc. expected when using the charging connector with unmatched symbol.

Electric charging label (For Europe) (Type A)



The electric charging label is attached on the charging door.

- 1 Warning for high voltage
 - 2 Warning for high voltage
 - 3 Warning for high voltage
 - 4 Symbol for charging door
 - 5 For further details, refer to "How to check the symbol on the charging label (For Europe) (if equipped)" on page 9-9.
 - 6 Charging voltage and current
(~): AC Single phase
(≡): AC 3 phase
 - 7 Symbols for charging type
 - 8 Symbols for charging type
 - 9 Symbols for charging type
- * For further details, refer to "Electric charging label symbol table (For Europe)" on page 9-12.

Electric charging label (For Europe) (Type B)



The electric charging label is attached on the charging door.



- 1 Warning for high voltage
 - 2 Warning for high voltage
 - 3 Warning for high voltage
 - 4 Symbol for charging door
 - 5 For further details, refer to "How to check the symbol on the charging label (For Europe) (if equipped)" on page 9-9.
 - 6 Charging voltage and current
(~): AC Single phase
(≡): AC 3 phase
 - 7 Symbols for charging type
 - 8 Symbols for charging type
 - 9 Symbols for charging type
- * For further details, refer to "Electric charging label symbol table (For Europe)" on page 9-12.

Electric charging label symbol table (For Europe)

AC and Trickle charger charging

Supply Type	Configuration	Type of Accessory	Voltage range	Identifier
AC	7P	Vehicle connector and vehicle inlet	≤ 480V RMS	

DC charging

Supply Type	Configuration	Type of Accessory	Voltage range	Identifier
DC	7P COMBO	Vehicle connector and vehicle inlet	50V to 500V	
			200V to 920V	

Abbreviation **A**

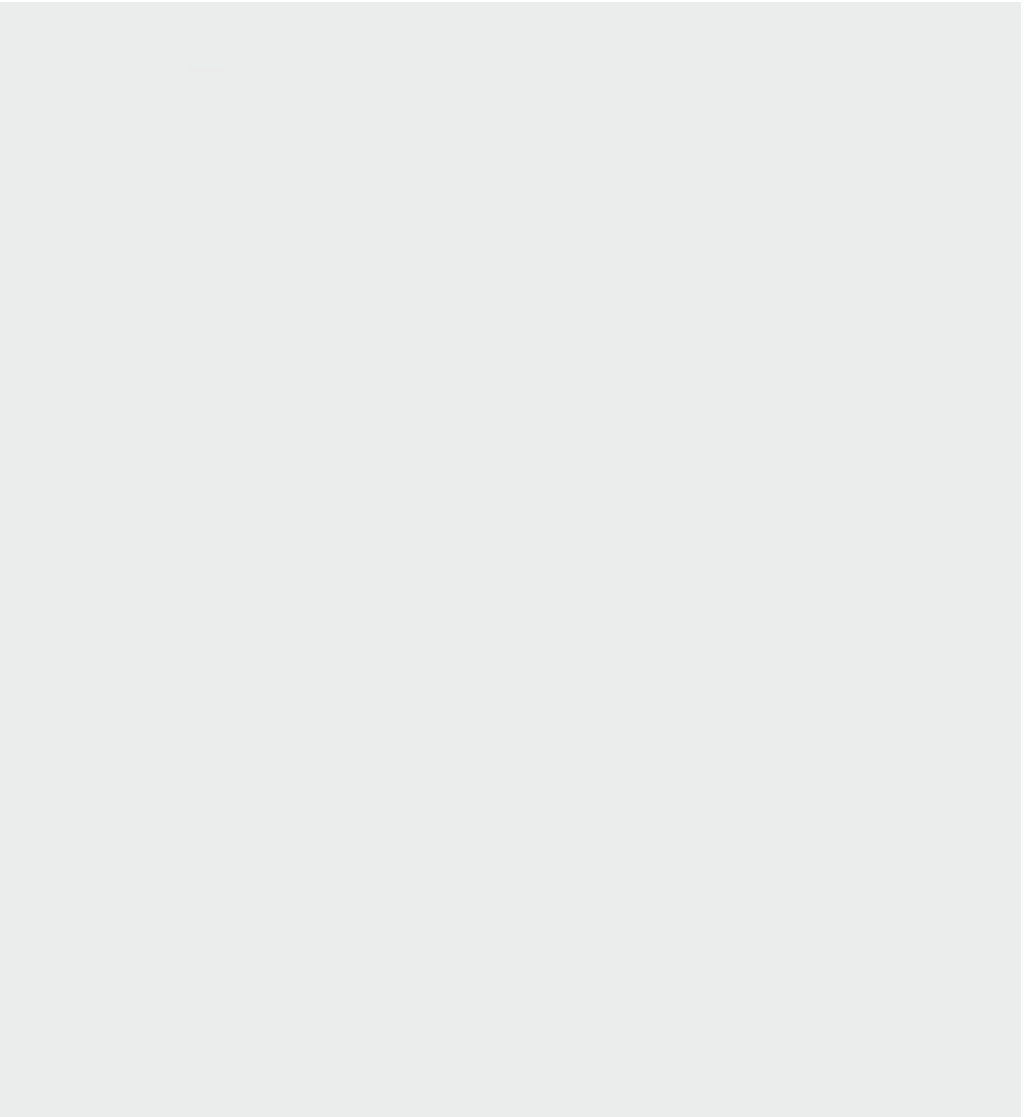

Abbreviation

ABS

Anti-lock Brake System

BAS

Brake Assistant System

BCW

Blind-Spot Collision Warning

CC

Cruise Control

CRS

Child Restraint System

DAW

Driver Attention Warning

DRL

Daytime Running Light

EBD

Electronic Brake force Distribution

ECM

Electric Chromic Mirror

ESC

Electronic Stability Control

ESS

Emergency Stop Signal

FCA

Forward Collision-Avoidance Assist

HAC

Hill-start Assist Control

HBA

High Beam Assist

HMSL

High Mounted Stop Lamp

ISLW

Intelligent Speed Limit Warning

LATCH

Lower Anchors and Tether for Children

LFA

Lane Following Assist

LKA

Lane Keeping Assist

MDPS

Motor Driven Power Steering

MIL

Malfunction Indicator Lamp

MSLA

Manual Speed Limit Assist

PDW

Reverse Parking Distance Warning

RCCW

Rear Cross-Traffic Collision Warning

RVM

Rear View Monitor

SBW

Shift-By-Wire

SCC

Smart Cruise Control

SRS

Supplemental Restraint System

SRSCM

SRS Control Module

Abbreviation

SVM

Surround View Monitor

TBT

Turn By Turn

TCS

Traction Control System

TIN

Tire Identification Number

TPMS

Tire Pressure Monitoring System

VIN

Vehicle Identification Number

VSM

Vehicle Stability Management

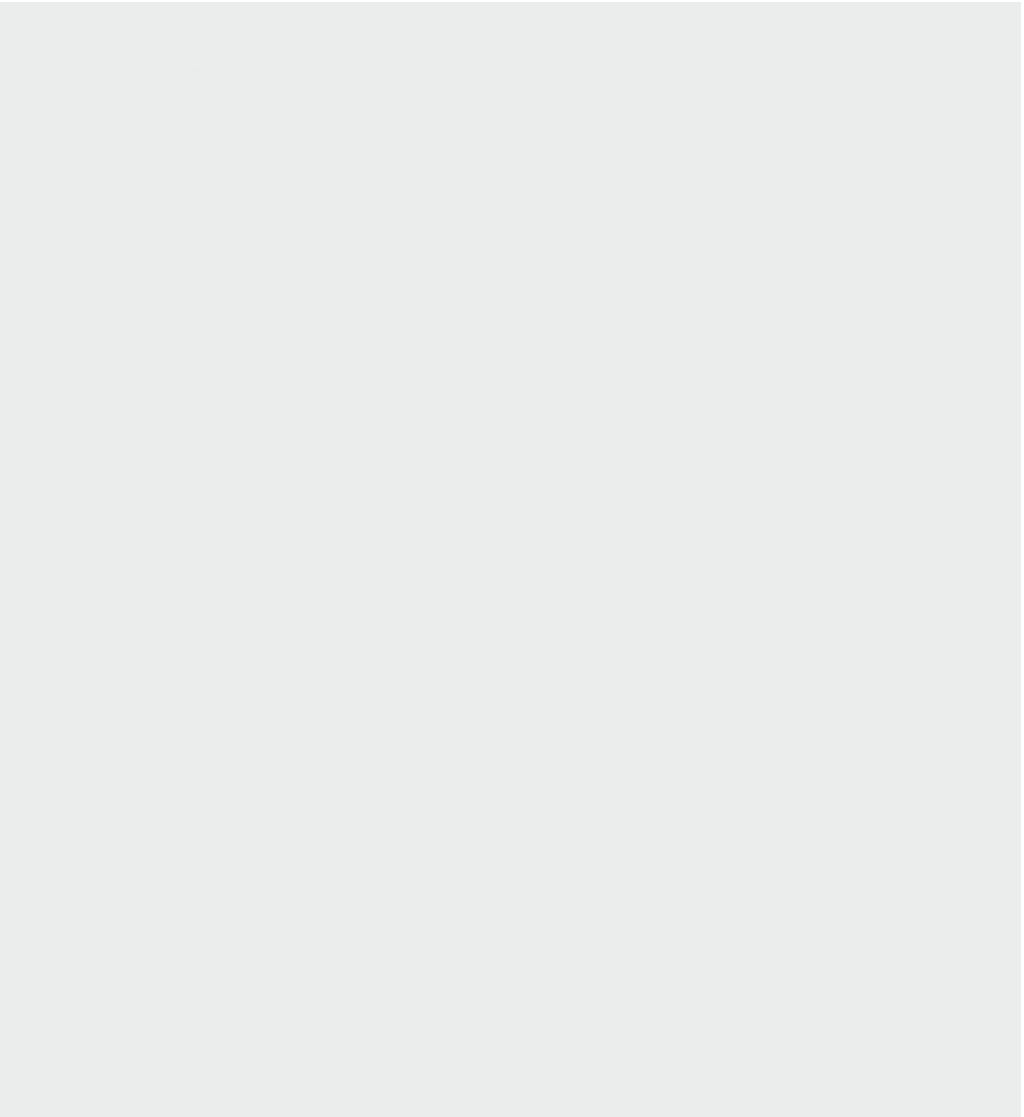

Index

A

AC charge	1-20
checking charging status	1-21
how to connect	1-20
how to disconnect	1-21
active air flap	6-33
malfunction	6-33
air bag	4-26
adding equipment to or modifying your air bag-equipped vehicle	4-43
additional safety precautions	4-42
air bag collision sensors	4-38
air bag inflation conditions	4-39
air bag non-inflation conditions	4-40
air bag warning labels	4-43
curtain air bag	4-37
driver's and passenger's front air bags	4-34
SRS care	4-41
SRS components and functions	4-32
warning and indicator light	4-29
air bag collision sensors	4-38
air bag warning and indicator light	4-29
air bag warning light	4-29
air bag warning labels	4-43
ambient lights	5-66
anti-lock brake system (ABS)	6-28
appearance care	8-42
exterior care	8-42
interior care	8-46
audio system	
radio	5-74
auto defogging	5-63
AUTO HOLD	6-26
automatic climate control system	5-55
changing temperature scale	5-59
climate information screen selection	5-60
controlling automatically	5-59
controlling fan speed	5-59
controlling the temperature	5-59
operating	5-56

B

battery	8-13
battery capacity label	8-14
battery recharging	8-14
for best battery service	8-13
reset items	8-15
battery saver function	5-42
before driving	6-5
good braking practices	6-6
good driving practices	6-5
necessary vehicle inspections	6-5
brake assist system (BAS)	6-30
brake disc cleaning	6-20
brake fluid	8-8
checking the brake fluid level	8-8
brake system	6-20
AUTO HOLD	6-26
brake disc cleaning	6-20
in the event of brake failure	6-20
parking brake	6-22

C

center console storage/glove box	5-64
charge indicator lamp for electric vehicle	1-15
charging status	1-15
charge types for electric vehicle	1-13
charging information	1-13
charging time information	1-13
charging types	1-14
charging and climate	1-8
off-peak time settings	1-9
target temperature settings	1-9
charging connector lock	1-15
locking charging cable	1-15
when the charging connector is locked	1-15
charging electric vehicle	1-17
charging door	1-17
precautions for charging electric vehicle	1-18
charging the electric vehicle (abrupt stop)	1-35

adjusting the headrest forward and backward	4-9
removing/reinstalling the headrest	4-9
heated steering wheel	5-23
hill-start assist control (HAC)	6-29
hood	5-20
closing the hood	5-20
opening the hood	5-20

I

immobilizer system	5-8
instrument cluster	5-28
interior features	5-66
ambient lights	5-66
coat hook	5-72
cup holders	5-66
floor mat anchors	5-73
power outlet	5-70
seat warmer/ventilation	5-67
sun visor	5-69
USB charger	5-69
wireless smart phone charging system	5-70
interior light	5-51
luggage room lamp	5-51
map lamp	5-51
room lamp	5-51
vanity mirror lamp	5-52
interior rearview mirror	5-25
day/night rearview mirror	5-25
electric chromic mirror (ECM)	5-25
ISOFIX anchorage system for children	4-22
securing a CRS with a lap/shoulder belt	4-24
securing a CRS with the "ISOFIX anchorage system"	4-23
securing a CRS with the "top-tether anchorage system"	4-23

K

keys	5-5
removing the mechanical key from the smart key	5-5
replacing the key battery	5-6

L

lamps	8-34
bulb replacement precautions	8-34
LCD display	5-31
changing LCD display modes	5-31
LCD display messages	5-37
LCD display modes	5-31
LCD display modes	
driving assist mode	5-33
master warning mode	5-34
service interval	5-34
trip computer mode	5-32
light bulbs	
light position (front)	8-36
light position (rear)	8-36
light position (side)	8-37
replacing license plate lamp (Bulb type)	8-40
replacing lights (LED type)	8-37
lighting	5-42
battery saver function	5-42
daytime running light (DRL)	5-43
headlamp escort function	5-42
headlamp leveling adjustment	5-47
lighting controls	5-43
traffic change (for europe)	5-43
lumbar support	4-5

M

main components of electric vehicle	1-4
high voltage battery warmer system	1-5
high voltage (HV) battery	1-4
maintenance	
climate control air filter	8-10
wiper blades	8-11
maintenance services	8-4
owner maintenance precautions	8-4
owner's responsibility	8-4
mirrors	5-25
interior rearview mirror	5-25
outside rear view mirror	5-26
motor compartment fuse panel	8-29
motor room compartment	8-3

O

one pedal driving	6-14
opening the hood	5-20
outside rear view mirror	5-26
adjusting	5-26
folding	5-26
owner maintenance schedule	8-5

P

parking brake	6-22, 6-23
electronic parking brake (EPB)	6-23
passenger's front air bag ON/OFF switch	4-29
portable charge	1-23
charging status indicator lamp for portable charger (Type A)	1-28
charging status indicator lamp for portable charger (Type B)	1-31
checking charging status	1-27
how to connect	1-26
how to disconnect	1-33
precautions	1-33
setting the charge level	1-24
power button	6-8
power outlet	5-70
precautions for charging electric vehicle	
unlock charging connector in emergency	1-18

R

rear door locks	
child-protector rear door lock	5-13
rear occupant alert (ROA)	5-14
reduction gear	6-10
changing gear	6-10
LCD display messages	6-12
shift-lock system	6-11
regenerative braking system	6-14
adjusting with paddle shifter	6-14
one pedal driving	6-14
replacing lights (LED type)	8-37
review of electric vehicle	1-3
road warning	7-2

hazard warning flasher	7-2
------------------------	-----

S

safety precautions for electric vehicle	1-47
scheduled charging	1-16
scheduled maintenance service	8-6
seat	4-3
adjusting the front seat	4-4
adjusting the rear seat	4-7
lumbar support	4-5
seatback pocket	4-5
seat belt restraint system	4-12
seat belt warning light	4-12
seat belt warning light	4-12
seat belts	4-11
care of seat belts	4-19
precautions	4-17
seat belt restraint system	4-12
seat warmer/ventilation	5-67
seatback pocket	4-5
selecting a CRS	4-20
CRS types	4-21
smart regeneration system	6-15
malfunction and limitations	6-16
operating	6-15
special driving conditions specifications	6-110
air conditioner compressor label	9-8
air conditioning system	9-3
bulb wattage	9-4
declaration of conformity	9-8
dimensions	9-2
electric vehicle specifications	9-2
how to check the symbol on the charging label (for europe)	9-9
motor number	9-7
recommended lubricants and capacities	9-6
refrigerant label	9-8
tire specification and pressure label	9-7
tires and wheels	9-5
vehicle certification label	9-7
vehicle identification number (VIN)	9-7
volume and weight	9-3
starting the vehicle	6-8
power button	6-8

steering wheel	5-23
adjusting the angle and height	5-23
heated steering wheel	5-23
horn	5-23
storage compartment	5-64
center console storage/glove box	5-64
sunglass holder	5-65
sun visor	5-69
sunglass holder	5-65

T

tailgate	5-15
emergency safety release	5-15
tailgate emergency safety release	5-15
theft-alarm system	5-7
armed stage	5-7
disarmed stage	5-7
theft-alarm stage	5-7
tire mobility kit	7-9
checking tire inflation pressure	7-12
components of the tire mobility kit	7-10
distributing the sealant	7-11
safe use of the tire mobility kit	7-13
using the tire mobility kit	7-11
tire pressure monitoring system (TPMS)	7-5
checking the tire pressure	7-5
malfunction indicator	7-7
when the telltale lights up	7-6
tires and wheels	8-15
checking tire inflation pressure	8-16
recommended cold tire inflation pressures	8-15
tire care	8-15
tire maintenance	8-19
tire replacement	8-17
tire rotation	8-17
tire sidewall labeling	8-19
tire traction	8-19
wheel alignment and tire balance	8-17
wheel replacement	8-18
towing	7-14
emergency towing	7-14
towing service	7-14
traffic change (for europe)	5-43

trip information (Trip computer)	
energy flow	5-33

U

unlock charging connector in emergency	1-18
USB charger	5-69

V

vehicle identification number (VIN)	9-7
vehicle power	6-8
starting the vehicle	6-8
vehicle safety system	6-28
anti-lock brake system (ABS)	6-28
brake assist system (BAS)	6-30
electronic stability control (ESC)	6-28
emergency stop signal (ESS)	6-30
hill-start assist control (HAC)	6-29
vehicle stability management (VSM)	6-29
vehicle stability management (VSM)	6-29
vehicle weight	6-117
base curb weight	6-117
cargo weight	6-117
GAW (gross axle weight)	6-117
GAWR (gross axle weight rating)	6-117
GVW (gross vehicle weight)	6-117
GVWR (gross vehicle weight rating)	6-117
overloading	6-117
vehicle curb weight	6-117
vehicle will not start	7-3
virtual engine sound system (VESS)	1-36

W

warning and indicator lights	5-39
washer fluid	8-9
checking the washer fluid level	8-9
welcome system	5-50
body silhouette lamp	5-50
headlamp escort function	5-50
interior lighting	5-50

windows	5-16
controlling windows switch	5-18
power windows automatic reversal	5-18
power windows lock button	5-19
resetting	5-18
windshield defrosting and defogging	5-63
auto defogging	5-63
defrosting/defogging the windshield	5-63
heat button	5-60
rear window/outside mirror defroster	5-63
winter driving	6-113
wiper blades	8-11
wipers and washers	5-48
washers	5-48
wipers	5-48
wireless smart phone charging system	5-70

