

FOREWORD

Dear Customer,

Thank you for selecting your new Kia vehicle.

As a global car manufacturer focused on building high-quality vehicles with exceptional value, Kia is dedicated to providing you with a customer service experience that exceeds your expectations.

If you need technical assistance, visit an authorized Kia dealership where factory-trained technicians, recommended special tools, and genuine Kia replacement parts can be provided.

This Owner's Manual will acquaint you with the operation of features and equipment that are either standard or optional on this vehicle, along with the maintenance needs of this vehicle. Therefore, you may find some descriptions and illustrations not applicable to your vehicle. You are advised to read this publication carefully and follow the instructions and recommendations. Please always keep this manual in the vehicle for your, and any subsequent owner's, reference.

All information contained in this Owner's Manual was accurate at the time of publication. However, as Kia continues to make improvements to its products, the company reserves the right to make changes to this manual or any of its vehicles at any time without notice and without incurring any obligations.

Please drive safely, and enjoy your Kia vehicle!

© 2022 Kia Corporation

All rights reserved. May not be reproduced or translated in whole or in part without the written consent of Kia Corporation.

Printed in Korea

How to use this manual

We want to help you get the greatest possible driving pleasure from your vehicle. Your Owner's Manual can assist you in many ways.

We strongly recommend that you read the entire manual. In order to minimize the chance of death or injury, you must read the WARNING and CAUTION sections in the manual.

Illustrations complement the words in this manual to best explain how to enjoy your vehicle. By reading your manual, you learn about features, important safety information, and driving tips under various road conditions.

The general layout of the manual is provided in the Table of Contents. Use the index when looking for a specific area or subject, it has an alphabetical listing of all information in your manual.

Chapters: This manual has nine chapters plus an index. Each chapter begins with a brief list of contents so you can tell at a glance if that chapter has the information you want.

You will find various WARNINGS, CAUTIONS, and NOTICES in this manual. These WARNINGS were prepared to enhance your personal safety. You should carefully read and follow ALL procedures and recommendations provided in these WARNINGS, CAUTIONS and NOTICES.

WARNING

A WARNING indicates a situation in which harm, serious bodily injury or death could result if the warning is ignored.

CAUTION

A CAUTION indicates a situation in which damage to your vehicle could result if the caution is ignored.

NOTICE

A NOTICE indicates interesting or helpful information is being provided.

Table of Contents

Introduction	①
Electric vehicle guide	②
Your vehicle at a glance	③
Safety features of your vehicle	④
Features of your vehicle	⑤
Driving your vehicle	⑥
What to do in an emergency	⑦
Maintenance	⑧
Specifications & Consumer information	⑨
Abbreviation	Ⓐ
Appendix	
Index	Ⓛ
Navigation QRG	

Introduction **1**

Vehicle modifications.....1-2
Vehicle handling instructions1-2

Introduction

Vehicle modifications

This vehicle should not be modified. Modification of your vehicle could affect its performance, safety or durability and may even violate governmental safety and emissions regulations.

In addition, damage or performance problems resulting from any modification may not be covered under warranty.

- Use of unauthorized electronic devices may cause abnormal operation of the vehicle, wire damage, battery discharge, or fire. For your safety, do not use unauthorized electronic devices.

Vehicle handling instructions

As with other vehicles of this type, failure to operate this vehicle correctly may result in loss of control, accident, or vehicle rollover.

Specific design characteristics (higher ground clearance, track, etc.) give this vehicle a higher center of gravity than other types of vehicles. In other words, it is not designed for cornering at the same speeds as conventional 2-wheel-drive vehicles.

Avoid sharp turns and abrupt maneuvers. Again, failure to operate this vehicle correctly may result in loss of control, accident, or vehicle rollover.

Be sure to read the "Reducing the risk of a rollover" on page 6-187.

Electric vehicle guide **2**

Review of electric vehicle	2-3
Main components of electric vehicle	2-4
• High Voltage (HV) battery (lithium-ion polymer)	2-4
• High voltage battery warmer system	2-5
EV menu	2-6
• EV mode screen.....	2-7
• Next departure.....	2-8
• Charging and climate.....	2-8
• Vehicle to load (V2L).....	2-9
• Nearby stations.....	2-14
• EV settings	2-14
Charge types for electric vehicle	2-17
• Charging information.....	2-17
• Charging time information	2-17
• Charging types.....	2-18
Charge indicator lamp for electric vehicle	2-19
• Charging status.....	2-19
Charging connector lock	2-19
• Locking charging cable	2-19
• When the charging connector is locked	2-19
Scheduled charging	2-20
Charging electric vehicle	2-21
• Electric charging door.....	2-21
Precautions for charging electric vehicle	2-22
• Unlock charging connector in emergency.....	2-22
AC charge	2-24
• How to connect AC charger	2-24
• Checking charging status.....	2-25
• How to disconnect AC charger	2-25

2 Electric vehicle guide

DC charge	2-26
• How to connect DC charger	2-26
• Checking charging status	2-27
• How to disconnect DC charger	2-27
Portable charge	2-28
• Setting the charge level of the portable charger	2-28
• How to connect portable charger (ICCB: In-Cable Control Box)	2-30
• Checking charging status	2-31
• Charging status indicator lamp for portable charger	2-32
• How to disconnect portable charger (ICCB: In-Cable Control Box)	2-34
• Precautions for portable charger (ICCB: In-Cable Control Box)	2-34
Charging the electric vehicle (Abrupt stop).....	2-35
Driving electric vehicle.....	2-36
• Starting the vehicle	2-36
• Stopping the vehicle	2-36
• Virtual Engine Sound System (VESS).....	2-36
• Distance to empty.....	2-37
• ECO driving	2-38
• Energy consumption	2-38
• Power/Charge gauge	2-39
• State of charge (SOC) gauge for high voltage battery	2-39
• Warning and indicator lights (related to electric vehicle)	2-40
• LCD display messages.....	2-41
Safety precautions for electric vehicle	2-46

Electric vehicle guide

Review of electric vehicle

An electric vehicle is driven using a battery and an electric motor. While general vehicles use an internal combustion engine and gasoline as fuel, electric vehicles use electrical energy that is charged & stored inside the high voltage battery.

As a result, electric vehicles are eco-friendly in that they do not require fuel and do not emit exhaust gases.

Characteristics of electric vehicles

It is driven using the electrical energy that is charged & stored inside the high voltage battery. This method prevents air pollution since fuel, like gasoline, is not required, negating the emission of exhaust gases.

A high performance electric motor is used in the vehicle as well. Compared to standard, internal combustion engine vehicles, engine noise and vibrations are much more minimal when driving.

When decelerating or driving downhill, regenerative braking is utilized to charge the high voltage battery. This minimizes energy loss and increases the distance to empty.

When the battery charge is not sufficient, AC charge (L2-Normal), DC charge and Trickle charge (L1-Trickle) are available. (Refer to "Charge types for electric vehicle" on page 2-17.)

Battery information

The vehicle is composed of a high voltage battery that drives the motor, air conditioner, and charges an auxiliary battery (12 V) that drives all other 12 V systems.

The auxiliary battery is automatically charged when the vehicle is in **READY** mode or the high voltage battery is being charged.

* NOTICE

What does regenerative braking do?

It uses the electric motor when decelerating and recaptures & transforms kinetic to electrical energy in order to charge the high voltage battery.

Main components of electric vehicle

- **On-Board Charger (OBC):** Transforms (inverts) AC power charge power, to DC power, to charge the high voltage battery
- **Inverter:** Transforms direct current into alternating current to supply power to the motor, and transforms alternating current into direct current to charge the high voltage battery.
- **LDC:** Transforms (converts) power from the high voltage battery to low voltage (12 V) to supply power to the vehicle (DC-DC).
- **VCU:** Functions as a supervisory controller of electric vehicle
- **Motor:** Uses electrical energy stored inside the high voltage battery to drive the vehicle (functions like an engine in a standard vehicle).
- **Reduction gear:** Delivers rotational force of the motor to the tires at appropriate speeds and torque.
- **High voltage battery (lithium-ion polymer):** Stores and supplies power necessary for the electric vehicle to operate (12 V auxiliary battery provides power to the vehicle features such as lights and wipers).

* OBC: On-Board Charger

* LDC: Low Voltage DC-DC Converter

* VCU: Vehicle Control Unit

High Voltage (HV) battery (lithium-ion polymer)

The HV battery powers the vehicle and peripheral devices.

The charge amount of the HV battery may gradually decrease when the vehicle is not driven or charged.

The battery capacity of the HV battery may decrease over time when the vehicle is stored in high temperatures and temporarily in low temperatures.

Distance to empty may vary depending on the driving conditions (cargo, rain, snow, wind, road surfaces), even if the charge amount is the same. The HV battery may expend more energy when driving a fast pace or uphill. These actions may reduce the distance to empty.

The high voltage battery is used when using the air conditioner/heater and/or use the pre-conditioning prior to departures. This may reduce the distance to empty. Make sure to set moderate temperatures when using the air conditioner/heater.

Natural degradation may occur with the high voltage battery depending on the number of years the vehicle was used and/or the number of charging cycles. This will reduce the distance to empty over time.

When the charge capacity and distance to empty keep falling, contact an authorized Kia dealer/service partner for inspection and maintenance.

If the vehicle will not be in use for an extended period of time, charge the high voltage battery once every three months to prevent it from discharging. Also, if the charge amount is not enough, immediately charge to full and store the vehicle.

AC (L2-Normal) charging is recommended to keep the high voltage battery in optimal condition.

If the HV battery is only charged to 80%, and you minimize the number of DC fast charging, you can keep the HV battery performance in optimal condition. (vs charging the HV battery to 100% an/or charging every drive cycle.)

The value of the high voltage battery charge level may vary according to the charging conditions (state of charger, outside temperature, battery temperature, etc.). In order to fully charge the battery, the current of the high voltage battery will be gradually decreased, so that the longevity and safety of the battery can be secured.

High voltage battery warmer system

The high voltage battery warmer system prevents reduction of battery output when battery temperature is low. If the charging connector is connected, the warmer system automatically operates according to the battery temperature.

Charging time may shorten compare to vehicles without the high voltage battery warmer system. But, electricity charge may increase because of high voltage battery warmer system operation.

WARNING

- Do not remove or disassemble high voltage components and high voltage battery connectors and/or wiring (orange cabling). Also, be careful not to damage high voltage components and the high voltage battery. It may cause serious injury and significantly impact the performance and durability of the vehicle.
- When inspection and maintenance is required for high voltage components and the high voltage battery, have the vehicle inspected by an authorized Kia dealer/service partner.

CAUTION

- Make sure to use a designated charger when charging the HV battery. Using different types of chargers may have a serious impact on vehicle durability.
- Make sure that the HV battery charge gauge does not reach E (Empty). If the vehicle is kept at E (Empty) for a long period, it may damage the high voltage battery and the high voltage battery may have to be replaced, depending on the level of degradation.
- If the vehicle is in a collision, contact an authorized Kia dealer/service partner to inspect whether the high voltage battery is still connected.
- If the vehicle is kept with insufficient charge for a long period, it may damage the high voltage battery and the high voltage battery may have to be replaced depending on the level of degradation.

- If the vehicle is in a collision, we recommend to visit an authorized Kia dealer/service partner to inspect whether the high voltage battery is still connected.
- Using the V2L function may reduce the mileage due to the use of high voltage battery energy, and repeated use of the V2L function may cause a decrease in the life of the high voltage battery.

*** NOTICE**

The high voltage battery warmer system operates when the charging connector is connected to the vehicle. However, the high voltage warmer system may not operate when battery temperature drops below -35 °C (-95 °F).

EV menu

If you select the **EV** menu at the multi-media system home screen, you can enter **EV** menu.

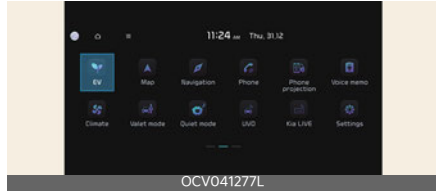

* The image of **EV** menu screen in this manual may differ from the actual screen depending on the vehicle specification and the version of the multi-media system software. For more detailed information, please refer to Navigation Quick Reference Guide.

EV mode screen



A. Electric Vehicle

1 Energy Information

2 Next Departure

3 Charging and Climate

4 Vehicle to Load (V2L)

5 Nearby Stations

6 EV Settings

7 Menu

Next departure



A: **Electric vehicle**
 1 **Next departure**

Select **EV** → **Next departure** on the screen. You can set the date and time of when to charge the battery, climate control temperature, and other various functions.

Departure time

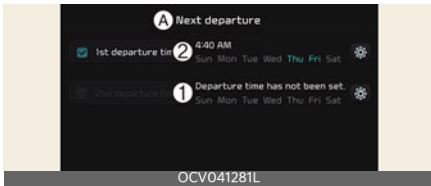

A: **Next departure**

- 1 **1st departure time**
- 2 **2nd departure time**

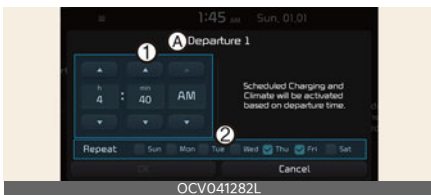

A: **Departure 1**

- 1 **Departure Time**
- 2 **Departure Day**

1. Set anticipated departure time for scheduled charging and target temperature.
2. Select the day of the week to activate scheduled charging and target temperature for departure time.

Charging and climate



A: **Electric Vehicle**
 1 **Scheduled charging and target temperature**

Select **EV** → **Charging and Climate** on the screen.

* NOTICE

Vehicle must be connected with the charging connector at the time pre-scheduled time for the scheduled charging.

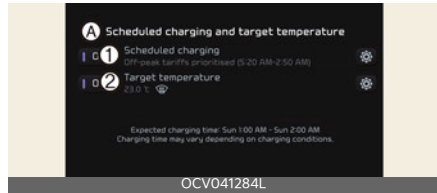

A: **Scheduled charging and target temperature**

- 1 **Scheduled Charging**
- 2 **Target Temperature**

You can set the date and time of when to charge the battery and the climate control temperature. Also, you may select the time to start charging using the Off-peak time settings.

Off-peak time settings

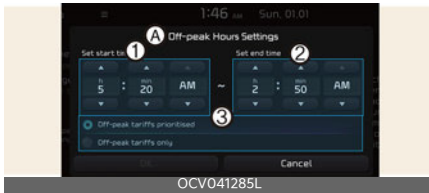

A: Off-peak time settings

1 Start Time

2 End Time

3 Charging options

- If selected, starts charging only on the designated off-peak time. If deselected, starts charging only on the scheduled time.
- Set the most inexpensive time to complete charging.
 - Off-peak tariffs prioritised: If selected, starts charging at off-peak time (may keep on charging pass off-peak time to charge 100%).
 - Off-peak tariffs only: If selected, charges only within off-peak time (may not charge 100%).

Target temperature Settings

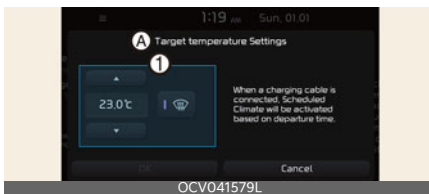

A: Target temperature Settings

1 Target temperature

- Set target temperature.

- If the target temperature (1) is set with the cable connected, the cabin temperature will be adjusted to the target temperature at departure time (without loss of high voltage)

battery charging level). In cold weather, pre-scheduled heating helps enhance electric vehicle performance by heating the vehicle in advance.

Vehicle to load (V2L)

V2L is the system that provides AC power using the high voltage battery for driving to operate several electrical products.

For more details, refer to "Vehicle to load (V2L)" on page 2-9.



A: Electric Vehicle

1 EV Charge Transfer

Select **EV → V2L (Vehicle to load)** on the screen.

You can set the battery discharging limit for high voltage battery for driving.

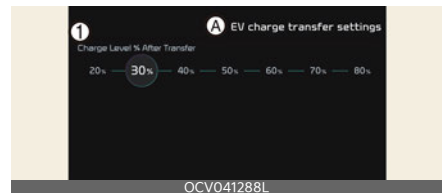

A: EV Charge Transfer Settings

1 Discharging Limit

If the vehicle reaches to the limit, it automatically cut supply of electricity.

Energy information

Select **EV** and see the vehicle image from the infotainment system screen. You can check battery discharging level.

How to connect

Outdoor (if equipped)

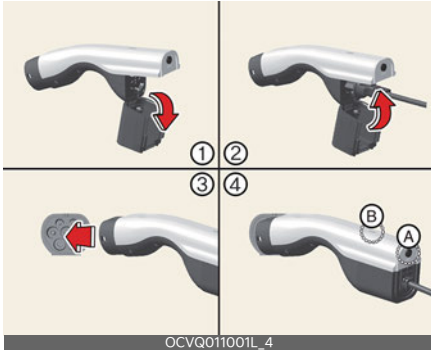

OCVQ011001L_4

1. Open the cover of the V2L connector.
2. Close the cover after connecting home appliances and electronic products to the power outlet.
3. Connect the V2L connector to the charging hole on the vehicle.
4. Press the switch (A) of the V2L connector and check whether the light (B) is on or off. The light (B) may not turn on normally when:
 - See the battery discharging limit for high voltage battery for driving in **Energy consumption** menu on the screen. If it is higher than the current amounts of high voltage battery, the light (B) does not turn on.
 - Check whether the light of V2L connector or indoor power outlet turns on or not.
 - If the warning message for V2L appears on the cluster, refer to

"LCD display messages" on page 2-11.

- If V2L does not operate previously when you connects another home appliances, we recommend to visit an authorized Kia dealer/service partner.
5. Press the switch (A) to turn off the light (B) the V2L will be off. You can disconnect the V2 connector when the light (B) turns off or the charging door lock is deactivated pressing the door unlock button on the smart key.

Indoor (if equipped)

1. Connect to the power outlet located in bottom of the rear seat with the EV button in the ON position.



OCVQ011002L

2. Use the mechanical key to unlock the power outlet cover.



OCVQ011046

3. Check the operation status through the front indicator of the power outlet.



- Blue: Standby
- Red: No power supply even the power outlet is connected
- Green: Normal power supply through the normal connection of the power outlet.

LCD display messages

V2L has ended. Battery level has reached the set value

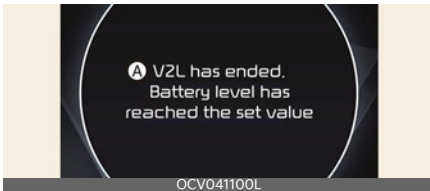

A: V2L has ended. Battery level has reached the set value

When the high voltage battery level reaches the discharging limit set level, the V2L will stop and the warning will be displayed. If you want to use the V2L continuously, make the discharging limit set level lower than the present battery level.

V2L stopped due to excessive power use



A: V2L stopped due to excessive power use

If you use an electrical appliance that exceeds the maximum power output the vehicle can supply, it will stop working and display a warning message. Make sure that the total power consumption of your electrical appliance exceeds the V2L maximum power output.

V2L conditions not met

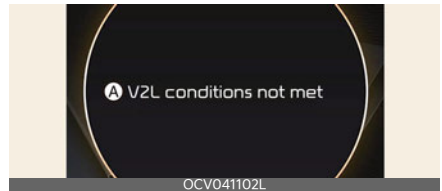

A: V2L conditions not met

If V2L is interrupted for any of the following reasons, a warning message is displayed.

- V2L connector switch off
- V2L connector overheating
- Opening the charging door while using the V2L indoor outlet

Make sure there are no problems with the V2L connector and the vehicle indoor outlet.

⚠ WARNING

- Do not touch the V2L connector of the terminal of the vehicle charging hole.

- Do not put metal objects to the V2L connector or charging hole. It might be a cause of electric shock.
- Do not touch the V2L connector, charging hole or power plug with a wet hand. It might be a cause of electric shock. Please handle with a dry hand all the time.
- Confirm whether there is foreign substance such as water or dust on the V2L connector, charging hole or power plug before connecting. If you connect it with foreign substances, it may be a cause of fire or electric shock.
- Do not remodel or disassemble the V2L connector. There is a risk of fire, electric shock or injury.
- When the power plug is connected or disconnected to the V2L connector or open or close the connector cover of the V2L, be careful not to be scratched on the hand.
- Do not charge in the following conditions. The accident might occur.
 - The V2L connector, charging hole, power plug or cable is damaged, corroded or rusted.
 - The connection part is loose.
- Do not use if the sheath of home appliance cables is damaged or broken. There is a risk of fire, electric shock or injury.
- Never use an electric heating appliance like iron, coffee pot, and toaster in the vehicle. It may cause a fire and injury.
- The V2L discharging mode is blocked automatically in case of overheating. (When the discharging mode is blocked, check whether the V2L connector or power plug is contaminated, worn, corroded or broken or the home appliance capacity is over 16 A. If the temperature falls to proper level after it is left unattended, you can use it again. Use proper home appliances.)
- Do not remodel or disassemble the provided V2L connector. The failure caused by remodeling or disassembling is not covered by the warrant.
- Do not drop the V2L connector or give a strong impact to it.
- Do not place objects on the V2L connector.
- Be sure to disconnect the V2L connector from the vehicle when you are finished using V2L.
- When the high voltage battery charge reaches the set discharging limit(%), the operation stops, and a warning message is displayed on the instrument cluster. If you want V2L operation, set the discharging limit(%) lower than the current battery charge.
- When using various electric products, use them below the maximum power capacity that can be supplied by the vehicle.
- If you use an electrical appliance that exceeds the maximum power capacity that the vehicle can supply, the operation will stop and a warning message will be displayed on the instrument cluster. Make sure the total power consumption of the electrical appliance you use does not exceed the V2L maximum power capacity.

CAUTION

- Be well-informed of the manual to prevent accidents.

- Some of the electric products may not operate normally even if the product has power consumption less than the maximum power capacity provided by the vehicle.
 - Electrical products that require high power during initial operation.
 - Measuring devices that need to process accurate data.
 - Electric products sensitive to inverter type AC power supply. (Inverter: A device that converts DC power into AC power)
- Do not use products that require a continuous power supply, such as medical equipment. The power supply may be interrupted depending on the vehicle's condition.
- Only use home appliances under 16 ampere.
- Put the power plug fully and use the qualified plug that meets the standard. If you use worn, corroded or broken plug or improper plug, it might be a cause of malfunction.
- Use the power plug with ground connection.
- Do not use high power home appliances such as air conditioner, washing machine or dryer.
- Do not hang home appliances on to the wire.
- For various devices connected to a power outlet, use only products that have obtained national safety certification. For usage and precautions, refer to the manual of the device. (Electrical appliances, multi-outlets, cord extension cables, etc.)
- For electronic devices that are used outdoors in a vehicle, use a product with a waterproof function or use it in a waterproof environment. Do not use in environments with rain or high humidity. (Electrical appliances, multi-outlets, cord extension cables, etc.)
- If there is a risk of lightning, do not use the V2L function outside the vehicle.
- Do not connect multiple portable multi-outlets.
- When using an extension cable, if the cable is twisted or overlapped by itself may cause a fire. Be sure to use the cable without twisting it.
- When using the vehicle's outdoor V2L connector, power is also supplied to the vehicle's indoor power outlet. Unplug electrical appliances that are not in use from the indoor power outlet.
- When using the V2L, the cooling fan in the vehicle motor compartment can operate automatically even if the vehicle is turned off. Do not put your hand near the cooling fan in the V2L operating state.

* NOTICE

- Please connect the V2L connector to the charging hole within 60 seconds after the charging cover opens. To prevent theft after connecting, it is changed to auto lock automatically so that it is impossible to separate.
- When using V2L, cancel the scheduled air conditioning setting. V2L may not be available to operate if the scheduled air conditioning is being activated.
- V2L discharging mode will shut off if the vehicle is turned off using indoor V2L.
- Opening the charging door or connecting the V2L connector to the

charging inlet, the V2L discharging mode will shut off. If you want to use the indoor and outdoor V2L simultaneously, firstly connect the V2L connector to the charging inlet and use the indoor V2L.

Nearby stations



A: Electric Vehicle

Select **EV** and see the map from the infotainment system screen. Stations around the current location are searched.



A: Electric Vehicle

Select the icon on the screen.



A: Near Current Position

Around the course, around the current site, around the selected destination or charging stations of interest will be searched. If you choose the charging station, the detailed information will be provided.

For more detailed information, please refer to **Navigation Quick Reference Guide**.

EV settings



A: Electric Vehicle

Select the icon on the screen. You can set the charging limit, charging current, winter mode and utility mode functions.

Charging limit

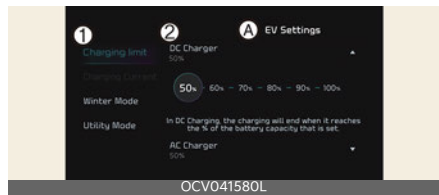

A: EV Settings

1 Charging limit

2 DC Charger

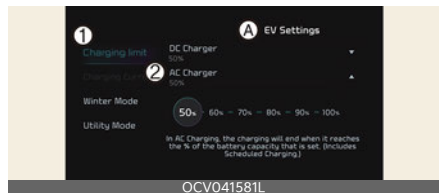

A: EV Settings

1 Charging limit

2 AC Charger

- The target battery charge level can be selected when charged with AC charger or DC charger.
- The charging level can be changed by 10%.

- If the target battery charge level is lower than the high voltage battery charge level, the battery will not be charged.

winter time when the high voltage battery temperature is low.

Charging current

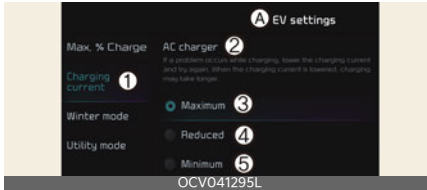

A: EV Settings

1 Charging current

2 AC Charger

3 Maximum

4 Reduced

5 Minimum

- You can adjust the charging current for an AC charger. Select an appropriate charging current.
- If the charging process does not start or abruptly stops in the middle, reselect another proper current and re-try charging the vehicle.
- Charging time varies depending on which charging current is selected.

Winter mode

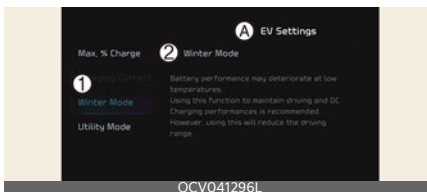

A: EV Settings

1 Winter mode

2 Winter mode

You can select or deselect **Winter mode**.

The Winter mode is efficient during the

This mode is recommended to improve driving and DC charging performances during winter by raising the battery temperature to an adequate level.

However, the driving distance may be reduced as the energy is required to increase battery temperature.

Also, if the battery temperature is low during driving or when scheduled air conditioner/heater is activated, this mode is operated to improve driving performance.

However, the mode is not operated to ensure driving distance when the battery level is low.

*** NOTICE**

This mode is available for the vehicles equipped with the battery heater.

Utility mode

The high voltage battery is used instead of the 12V auxiliary battery for operating the convenient features of the vehicle. When driving is not necessary such as while camping or when stopping the vehicle for a long time, it is possible to use the electrical devices (audio, lights, air conditioner, heater, etc.) for long hours.

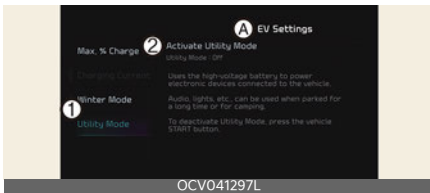

A: EV Settings

1 Utility mode

2 Activate Utility Mode

System setting and activation

System setting

The driver can activate the Utility mode function when the following conditions are satisfied.

- The vehicle is in **READY** mode and the gear is shifted to P (Park).
- The EPB (Electronic Parking Brake) is not a malfunction.
- **EV settings** → **Utility mode** is selected on the infotainment system screen.

System activation

When the system is activated:

- The **READY** indicator will turn off, and the **UTIL** indicator will illuminate on the cluster and the EPB is applied.
- All electric devices are usable but the vehicle cannot be driven.
- The EPB can be canceled by pressing the EPB switch.

Gear cannot be shifted out of P (Park). If a shift attempt is made, **Shifting conditions not met** message will be displayed on the infotainment system screen.

System deactivation

The Utility mode can be deactivated by pressing the EV button to the OFF position. The function cannot be deactivated from the **EV settings**.

Charge types for electric vehicle

Charging information

- **AC Charge:** The electric vehicle is charged by plugging into a AC charger installed at your home or a public charging station. (For further details, refer to "AC charge" on page 2-24.)
- **DC Charge:** You can charge at high speeds at public charging stations. Refer to the respective company's manual that is provided for each DC charger type. Battery performance and durability can deteriorate if the DC charger is used constantly.

Use of DC charge should be minimized in order to help prolong high voltage battery life.

- **Portable Charge:** The Electric vehicle can be charged by using household electricity. The electrical outlet at your home must comply with regulations and can safely accommodate the Voltage/Current (Amps)/Power (Watts) ratings specified on the portable charge.









Charging time information

Charging type		Standard battery type	Extended battery type
AC charge		Takes approx. 9 hours at room temperature when charged to 100%	Takes approx. 11 hours 45 minutes at room temperature when charged to 100%
DC charge	350 kW charger	Takes about 18 minutes at room temperature when charged from 10% to 80%. Can be charged to 100%.	Takes about 18 minutes at room temperature when charged from 10% to 80%. Can be charged to 100%.
	50 kW charger	Takes about 63 minutes at room temperature when charged from 10% to 80%. Can be charged to 100%.	Takes about 73 minutes at room temperature when charged from 10% to 80%. Can be charged to 100%.
Portable charge		Takes approx. 25 hours at room temperature when charged to 100%.	Takes approx. 33 hours at room temperature when charged to 100%.

* NOTICE

Depending on the condition and durability of the high voltage battery, charger specifications, and ambient temperature, the time required for charging the high voltage battery may vary.

Charging types

Category	AC Charge	DC Charge	Portable Charge
Charging Inlet (Vehicle)	 OCVQ011003L	 OCVQ011004L	 OCVQ011003L
Charging Connector	 OCVQ011005L	 OCVQ011006L	 OCVQ011005L
Charging Outlet	 OCVQ011007L	 OCVQ011008L	 OCVQ011009L
How to Charge	Use AC charger installed at home or public charging station	Use the DC charger at public charging station	Use household current

- Actual charger image and charging method may vary in accordance with the charger manufacturer.
- A maximum diagnosis time of 3 minutes may be added to check the battery condition during the battery charging process.

Charge indicator lamp for electric vehicle

Charging status

When charging the high voltage battery, the charge level can be checked from outside the vehicle.

Electric charging door



Lamp status	Battery SOC [%]
	0~24
	25~49
	50~74
	75~100

Charging connector lock

Locking charging cable

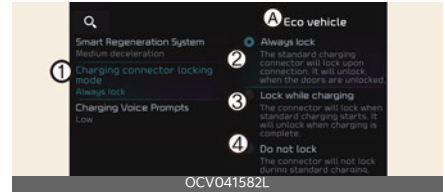

A: ECO Vehicle

- 1 Charging connector locking mode
- 2 Always lock
- 3 Lock while charging
- 4 Do not lock

You may select when the charging connector can be locked and unlocked in the charging inlet.

Select **Settings** → **Vehicle** → **ECO Vehicle** → **Charging connector locking mode** in the infotainment system.

When the charging connector is locked

Category	While charging	Always
Before charging	X	O
While charging	O	O
Finished charging	X	O

Always lock mode

The connector locks when the charging connector is plugged into the charging inlet. The connector is locked until all doors are unlocked by the driver. This mode can be used to prevent charging cable theft.

- If the charging connector is unlocked when all doors are unlocked, but the charging cable is not disconnected within 15 seconds, the connector will be automatically locked again.

- If the charging connector is unlocked when all doors are unlocked, but all doors are locked again, immediately, the connector will be automatically locked again.

Lock while charging mode

The connector locks when charging starts. The connector unlocks when charging is complete. This mode can be used when charging in a public charging station.

Do not lock mode

The connector unlocks regardless of the state of charging. Press the charging connector release button, disconnect the connector. Be careful to theft of the charging cable.

Scheduled charging

You can set-up a charging schedule for your vehicle using the Infotainment system or Kia Connect application. Refer to Navigation Quick Reference Guide for detailed information about setting scheduled charging.

Scheduled charging can only be done when using a AC charger or the portable charger (ICCB: In-Cable Control Box).



When scheduled charging is set and the AC charger or the portable charger (ICCB: In-Cable Control Box) is connected for charging, the indicator lamp blinks from the first level to the last for about 3 minutes to indicate that scheduled charging is set.

When scheduled charging is set, charging is not initiated immediately when the AC charger or portable charger (ICCB: In-Cable Control Box) is connected. When immediate charging is required, press and hold the charging button on the charging door for 2 seconds or deactivate the scheduled charge setting with the infotainment system or Kia Connect application.

Refer to "AC charge" on page 2-24 or "Portable charge" on page 2-28 for details about connecting the AC charger and the portable charger (ICCB: In-Cable Control Box).

Charging electric vehicle

Electric charging door







The electric charge door will open and close as follows.

* NOTICE

The charging door automatically closes when:

- The charge connector is disconnected
- The charging procedure has not done for approximately 2 minutes while the charging door is opened.
- The gear is in D (drive), N (neutral), or R (Reverse).

Methods	Open	Close
Push/Touch	 <p>OCVQ011012L</p> <p>Push the charging door.</p>	 <p>OCVQ011013L_2</p> <p>Press the charging door close button.</p>
Charging door open/close button	 <p>OCVQ011014L</p>	
Voice Recognition		

Precautions for charging electric vehicle

AC charger



AC charging cable (if equipped)



DC charger



* Actual charger image and charging method may vary in accordance with the charger manufacturer.

Unlock charging connector in emergency

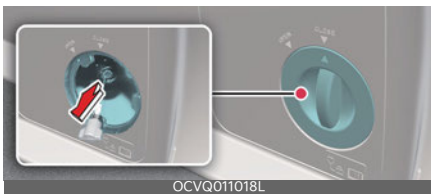

If the charging cable does not detach due to battery discharge and failure of the electric wires, open the tailgate and slightly pull the emergency cable as

shown above. The charging connector will then unlock.

WARNING

- Electromagnetic waves that are generated from the charger can seriously impact medical electric devices, such as an implantable cardiac pacemaker. When using electronic medical devices, such as an implantable cardiac pacemaker, make sure to ask the medical team and manufacturer whether charging your electric vehicle will impact the operation of the medical electric devices, such as an implantable cardiac pacemaker.
- Check to make sure there is no water or dust on the charging cable connector and plug before connecting to the charger and charging inlet. Connecting while there is water or dust on the charging cable connector and plug may cause a fire or electric shock.
- Be careful not to touch the charging connector, charging plug, and the charging inlet when connecting the charging connector cable to the charging outlet and the charging inlet on the vehicle.
- Comply with the following in order to prevent electrical shock when charging:
 - Use a waterproof charger.
 - Do not touch the charging connector and charging plug with your hands wet, or do not stand in water or snow while connecting the charging cable.
 - Be careful when there is lightning.
 - Be careful when the charging connector and plug are wet.

- Immediately stop charging when you discover abnormal symptoms (e.g., smell, smoke).
- Replace the charging cable if the cable coating is damaged to prevent electrical shock.
- When connecting or removing the charging cable, make sure to hold the charging connector handle.
- Only use the charging cable (if equipped) certified by Kia. If you use a separate extension cable such as a reel or use an uncertified cable, it may cause abnormalities of electrical outlets, leading to fire or explosion.
- If you pull the cable itself (without using the handle), the internal wires may be disconnected or get damaged. This may lead to electric shock or fire.
- Do not leave the vehicle with the charging door open. An open charging door may indicate that the vehicle door has been unlocked and may be subject to vehicle theft.

CAUTION

- Always keep the charging connector and charging plug in clean and dry condition. Be sure to keep the charging cable in a condition where there is no water or moisture.
- Make sure to use the designated charger for charging the electric vehicle. Using any other charger may cause failure.
- Before charging the battery, turn the vehicle [OFF].
- When the vehicle is switched [OFF] while charging, the cooling fan inside the motor compartment may auto-

matically operate. Do not touch the cooling fan while charging.

- Be careful not to drop the charging connector. The charging connector can be damaged.
- Do NOT use a extension cord, when using the L1-Trickle charger, as this may overheat and/or cause damage.

NOTICE

When charging or right after charging the high voltage battery, the cooling will be made using air conditioner system in order to control the high voltage battery temperature.

At this time, the noise might occur by the air conditioner compressor and cooling fan, but this is due to normal operation.

AC charge



OCVQ011007L

* Actual charger image and charging method may vary in accordance with the charger manufacturer.

How to connect AC charger

1. Depress the brake pedal and apply the parking brake.
2. Turn OFF all switches, shift to P (Park), and turn OFF the vehicle. If charging is initiated without the gear in P (Park), the charging will start after the gear is automatically shifted to P (Park).
3. Open the charging door.



OCVQ011012L

For more details, refer to "Electric charging door" on page 2-21.

4. Check if there is dust on the charging connector and charging inlet.
5. Hold the charging connector handle and connect it to the vehicle charging inlet. Push the connector all the way in. If the charging connector and charging terminal are not connected properly, this may cause a fire.

For more details, refer to "Locking charging cable" on page 2-19.

6. Connect the charging plug to the electric outlet at a AC charging station to start charging.
7. Check if the charging indicator light (S) of the high voltage battery in the instrument cluster is turned ON. Charging is not active when the charging indicator light (S) is OFF. When the charging connector and charging plug are not connected properly, reconnect the charging cable to charge.

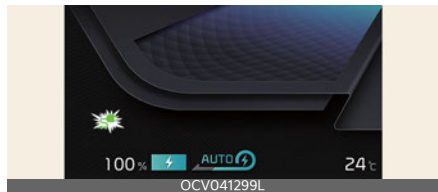

OCV041299L

8. After charging has started, the estimated charging time is displayed on the instrument cluster for about 1 minute.

If you open the driver seat door while charging, the estimated charging time is also displayed on the instrument cluster for about 1 minute. When scheduled charging or scheduled air conditioner/heater is set, the estimated charging time is displayed as "-".



OCV041103L

A: Remaining Time

Checking charging status

When charging the high voltage battery, the charge level can be checked from outside the vehicle.

For more details, refer to "Charge indicator lamp for electric vehicle" on page 2-19.

How to disconnect AC charger

1. When charging is complete, remove the charging plug from the electrical outlet of the AC charging station.



2. Hold the charging connector handle and pull it out.



3. Make sure to completely close the charging door.
4. Close the protection caps of the charging connector and the charging plug to protect them from foreign substances.
5. If the personal charging connector is used, store the connector in the cable compartment.

* NOTICE

- If you cannot open the charging door due to freezing weather, tap lightly or remove any ice near the charging door. Do not try to forcibly open the charging door.
- Locking Charging Cable Select **Settings** → **Vehicle** → **ECO Vehicle** → **Charging connector locking mode** in the infotainment. The charging connector is locked in the inlet at a different period according to which mode is selected.
 - **Always lock** mode: The connector locks when the charging connector is plugged into the charging inlet.
 - **Lock while charging** mode: The connector locks when charging starts.
- Even though charging is possible with the EV button in the ON/START position, for your safety, start charging when the EV button is in the OFF position and the vehicle shifted to P (Park). After charging has started, you can use electrical components such as the radio by pressing the EV button to the ACC or ON position.
- During AC charging, the radio reception may be bad.
- During charging, the gear cannot be shifted from P (Park) to any other gear.
- Depending on the condition and durability of the high voltage battery, charger specifications, and ambient temperature, the time required for charging the battery may vary.

DC charge



You can charge at high speeds at public charging stations. Refer to the respective company's manual that is provided for each DC charger type.

Battery performance and durability can deteriorate if the DC charger is used constantly.

Use of DC charge should be minimized in order to help prolong high voltage battery life.

Actual charger image and charging method may vary in accordance with the charger manufacturer.

How to connect DC charger

1. Depress the brake pedal and apply the parking brake.
2. Turn OFF all switches, shift to P (Park), and turn OFF the vehicle.
3. Open the charging door.

For more details, refer to "Electric charging door" on page 2-21.

4. Check whether there is dust or foreign substances inside the charging connector and charging inlet.
5. Hold the charging connector handle and connect it to the vehicle charging inlet. Push the connector all the way in. If the charging connector and charging terminal are not connected properly, this may cause a fire. Refer to the manual for each type of DC charger for how to charge and remove the charger.

6. Check if the charging indicator light (S⁺) of the high voltage battery in the instrument cluster is turned ON. Charging is not active when the charging indicator light (S⁺) is OFF. When the charging connector is not connected properly, reconnect the charging cable to charge it again. During cold weather, DC charging may not be available to prevent high voltage battery degradation.

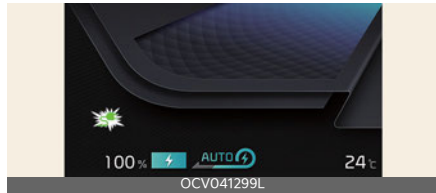

7. After charging has started, the estimated charging time is displayed on the instrument cluster for about 1 minute. If you open the driver seat door while charging, the estimated charging time is also displayed on the instrument cluster for about 1 minute.

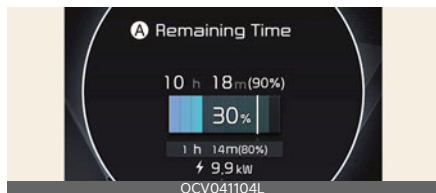

A: Remaining Time

Checking charging status

When charging the high voltage battery, the charge level can be checked from outside the vehicle.

For more details, refer to "Charge indicator lamp for electric vehicle" on page 2-19.

How to disconnect DC charger

1. Remove the charging connector when DC charging is completed, or after you stop charging using the DC charger. Refer to each respective DC charger manual for details about how to disconnect the charging connector.
2. Make sure to completely close the charging door.

⚠ CAUTION

High frequency noise may be intermittently heard from outside the vehicle when charging with old DC charging stations or DC charging stations with communication delay.

This high frequency noise is heard when the vehicle operates the function to reduce electromagnetic waves on its own to maintain charging. Thus, it is the normal functional behavior of the vehicle which does not affect charging or vehicle performance.

*** NOTICE**

- If you use a DC charger when the vehicle is already fully charged, some DC chargers will send out an error message. When the vehicle is fully charged, do not charge the vehicle.
- If you cannot open the charging door due to freezing weather, tap lightly or remove any ice near the charging door. Do not try to forcibly open the charging door.

- To control the temperature of the high voltage battery while charging, the air conditioner is used to cool down the battery which may generate noise from operation of the air conditioner compressor and cooling fan.

Also, the air conditioner's performance may be degraded during summer due to operation of the cooling system for the high voltage battery.

- Even though charging is possible with the EV button in the ON/START position, for your safety, start charging when the EV button is in the OFF position and the vehicle shifted to P (Park). After charging has started, you can use electrical components such as the radio by pressing the EV button to the ACC or ON position.

During charging, the gear cannot be shifted from P (Park) to any other gear.

- Depending on the condition and durability of the high voltage battery, charger specifications, and ambient temperature, the time required for charging the battery may vary.

Portable charge

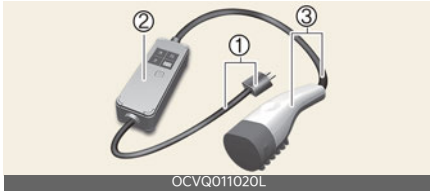

- 1 Code and Plug (Code set)
- 2 Control Box
- 3 Charging Cable and Charging Connector

Portable Charge can be used when AC Charge or DC Charge is not available by using household electricity.

Setting the charge level of the portable charger

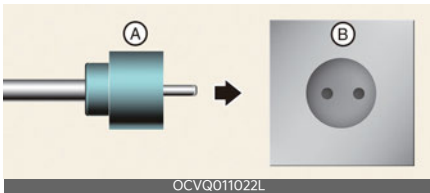

- A: Plug
- B: Electric Outlet

1. Check the rated current of the electric outlet prior to connecting the plug to the outlet.
2. Connect the plug to a household electric outlet.
3. Check the display window on the control box.

4. Press the button (1) on the back of the control box for 2 to 8 seconds to adjust the charge level. (Refer to charging cable type and example for setting the charge level.)



5. The charge level on the display window of the control box changes every time you press the button (1).
6. When setting the charge level is complete, start charging according to the portable charge procedure.

* Example for setting the ICCB charge level

* The example is only for reference and may vary according to the surrounding environment.

Outlet current	ICCB charge level	Control box display window
14-16A	12A	
13-12A	10A	
11-10A	8A	
9-8A	6A	

2

⚠ CAUTION

Please make sure that charge level selection matches the capacity of your circuit breaker to avoid blown fuse.

How to connect portable charger (ICCB: In-Cable Control Box)

1. Connect the plug to a household electric outlet.

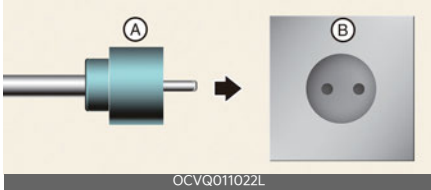

- A: Plug
- B: Electric Outlet

2. Check if the power lamp (green) illuminates on the control box.

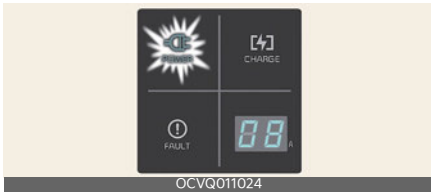

3. Depress the brake pedal and apply the parking brake.
4. Turn OFF all switches, shift to P (Park), and turn OFF the vehicle. If charging is initiated without the gear in P (Park), the charging will start after the gear is automatically shifted to P (Park).

5. Open the charging door.

For more details, refer to "Electric charging door" on page 2-21.

6. Open the protection caps of the charging connector and the charging plug. Check if there are any foreign substances or dust.
7. Hold the charging connector handle and connect it to the vehicle charging inlet. Push the connector all the way in. If the charging connector and charging terminal are not connected properly, this may cause a fire.

8. Charging starts automatically (charging lamp illuminates).



9. Check if the charging indicator light (S) of the high voltage battery in the instrument cluster is turned ON. Charging is not active when the charging indicator light (S) is OFF. When the charging connector is not connected properly, reconnect the charging cable to charge it again.

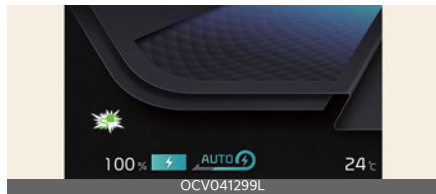

10. After charging has started, the estimated charging time is displayed on the instrument cluster for about 1 minute.



A: Remaining Time

If you open the driver seat door while charging, the estimated charging time is also displayed on the instrument cluster for about 1 minute. When scheduled charging or scheduled air conditioner/heater is set, the estimated charging time is displayed as "-".

Checking charging status

When charging the high voltage battery, the charge level can be checked from outside the vehicle.

For more details, refer to "Charge indicator lamp for electric vehicle" on page 2-19.

* NOTICE

- If you cannot open the charging door due to freezing weather, tap lightly or remove any ice near the charging door. Do not try to forcibly open the charging door.
- Locking Charging Cable Select **Settings** → **Vehicle** → **ECO Vehicle** → **Charging connector locking mode** in the infotainment system. The charging connector is locked in the inlet at a different period according to which mode is selected.
 - **Always lock** mode: The connector locks when the charging connector is plugged into the charging inlet.
 - **Lock while charging** mode: The connector locks when charging starts.

For more details, refer to "Charging connector lock" on page 2-19.

- Even though charging is possible with the EV button in the ON/START position, for your safety, start charging when the EV button is in the OFF position and the vehicle shifted to P (Park). After charging has started, you can use electrical components such as the radio by pressing the EV button to the START or ON position.

During charging, the gear cannot be shifted from P (Park) to any other gear.

- Depending on the condition and durability of the high voltage battery, charger specifications, and ambient temperature, the time required for charging the battery may vary.

Charging status indicator lamp for portable charger

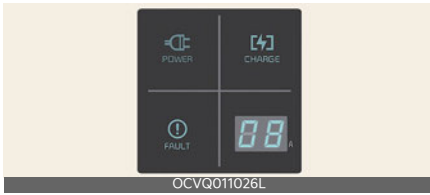

Indicator		Details
POWER		On: Power on
CHARGE		On: Charge Blink: Current limit due to high plug temperature or high internal temperature
FAULT		Blink: Charging interrupted
CHARGE LEVEL	12	12 A
	10	10 A
	08	8 A
	06	6 A
	<p>The charging current changes whenever the button (1) is pressed for less than 1 sec with the charger plugged into an electrical outlet but not the vehicle.</p> <p style="text-align: center;">Control box</p> <p>The image shows a close-up of the control box of the portable charger. It is a grey rectangular device with a digital display showing '5.5'. Below the display is a blue button with a white circle containing the number '1'. A red arrow points to this button. The model number 'OCVQ011021L' is printed at the bottom of the image.</p>	

Status/Diagnosis/Countermeasure

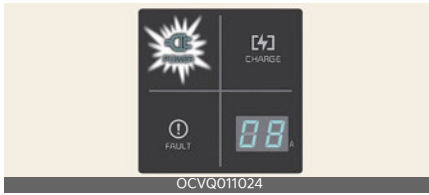

- Charging connector plugged into vehicle (**POWER** Green ON)
- Plug connected to an electric outlet (**POWER** Green ON)

Plugged into vehicle (POWER Green ON, FAULT Red Blink)



- Diagnostic device failure
- Current leakage
- Abnormal temperature

While charging



- Charge indicator (**POWER** Green ON/ **CHARGE** Blue ON)
- Charging current

Leakage current failure (POWER Green ON, FAULT Red Blink)



- After disconnecting and reconnecting the power plug, press and release the button for 2 seconds or longer to clear the error.

Before plugging charging connector into vehicle (POWER Green ON, FAULT Red blink)



- Abnormal temperature
- CCB (In-Cable Control Box) failure

Power saving mode



- Charge level indicator is turned off if there is no status change for more than 1 minute.

How to disconnect portable charger (ICCB: In-Cable Control Box)

1. Hold the charging connector handle and pull it out.



2. Make sure to completely close the charging door.
3. Disconnect the plug from the household electric outlet. Do not pull the cable when disconnecting the plug.

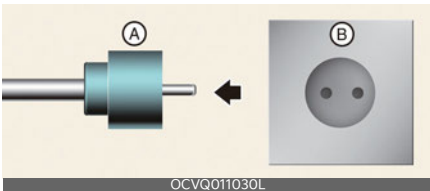

A: Plug
B: Electric Outlet

4. Close the protection caps of the charging connector and the charging plug to protect them from foreign substances.
5. If the personal charging connector is used, store the connector in the cable compartment.

Precautions for portable charger (ICCB: In-Cable Control Box)

- Use the portable charger that is certified by an authorized Kia dealer/service partner.
- Do not try to repair, disassemble, or adjust the portable charger.
- Do not use an extension cord or adapter.
- Stop using immediately when failure occurs.
- Do not touch the plug and charging connector with wet hands.
- Do not touch the terminal part of the AC charging connector and the AC charging inlet on the vehicle.
- Do not connect the charging connector to voltage that does not comply with regulations.
- Do not use the portable charger if it is worn out, exposed, or there exists any type of damage on the portable charger.
- If the ICCB case and AC charging connector is damaged, cracked, or the wires are exposed in any way, do not use the portable charger.
- Do not let children operate or touch the portable charger.
- Keep the control box free of water.
- Keep the normal charging connector or plug terminal free of foreign substances.
- Do not step on the cable or cord. Do not pull the cable or cord and do not twist or bend it.
- Do not charge when there is lightning.
- Do not drop the control box or place a heavy object on the control box.
- Do not place an object that can generate high temperatures near the charger when charging.
- Charging with the worn out or damaged household electric outlet can result in a risk of electric shock. If you are in doubt to the household electric outlet condition, have it checked by a licensed electrician.
- Stop using the portable charger immediately if the household electric

outlet or any components is overheated or you notice burnt odors.

* NOTICE

To prevent charging cable theft, the charging connector cannot be disconnected from the inlet when the doors are locked or the charging connector is in the **Always lock** mode. Unlock all doors to disconnect the charging connector from the inlet.

However, if the vehicle is in the charging connector **Lock while charging** mode, the charging connector automatically unlocks from the inlet when charging is completed.

If the charging connector is disconnected while the release button is not pressed, the connector and the inlet may be damaged.

For more details, refer to "Charging connector lock" on page 2-19.

If the release button does not work even after the all doors are unlocked, pull the emergency lift cable in the motor room and press the release button in the connector to disconnect it from the vehicle. If the release button still does not work, we recommend to visit an authorized Kia dealer/service partner.

Charging the electric vehicle (Abrupt stop)

Action to be taken when charging stops abruptly

When the high voltage battery does not charge, check the followings:

- Check the charging setting for the vehicle. Refer to "EV settings" on page 2-14 (e.g. When scheduled charging is set, charging is not initiated immediately when the AC charger or portable charger (ICCB: In-Cable Control Box) is connected.)
- Check the operation status of AC charger, portable charger and DC charger. (Refer to "Charging status" on page 2-19)
 - * Actual method for indicating the charging status may vary in accordance with the charger manufacturer.
- When the vehicle does not charge and a warning message appears on the cluster, check the corresponding message. Refer to "LCD display messages" on page 2-41.
- If the vehicle is properly charged when charged with another normally working charger, contact the charger manufacturer.
- If the vehicle does not charge when charged with another normally working charger, we recommend that you contact an authorized Kia dealer/service partner for inspection.
- If charging fails and the service warning light () is lit in the cluster, we recommend that you contact an authorized Kia dealer/service partner.

Driving electric vehicle

This section describes how to start and stop the vehicle, what is displayed on the various gauges and LCD displays, and so on.

Starting the vehicle

1. Holding the smart key, sit in the driver's seat.
2. Fasten the seat belt before starting the vehicle.
3. Make sure to engage the parking brake.
4. Check the position of the accelerator pedal and the brake pedal and the clearance with your right foot.
5. Make sure to depress and hold the brake pedal.
6. While depressing the brake pedal, shift to P (Park).
7. Depress and hold the brake pedal while pressing the EV button.
8. When the **READY** indicator is ON, you can drive the vehicle. When the **READY** indicator is OFF, you cannot drive the vehicle. Restart the vehicle.

Vehicle ON → **READY** (green)



9. Depress and hold the brake pedal and shift to the desired position
10. Release the parking brake and slowly release the brake pedal. Check if the vehicle slowly moves forward, then depress the accelerator pedal.

Stopping the vehicle

1. Hold down the brake pedal while the vehicle is parked.
2. Shift to P (Park).
3. Engage the parking brake.
4. Press the EV button and turn off the vehicle.
5. Check if the **READY** indicator is turned OFF in the instrument cluster. When the **READY** indicator is ON and the gear is in a position other than P (Park), the driver can accidentally depress the accelerator pedal, causing the vehicle to move unexpectedly.

Vehicle OFF



Virtual Engine Sound System (V ESS)

The Virtual Engine Sound System (V ESS) generates an engine sound for pedestrians to hear the vehicle because there is no sound while the Electric Vehicle (EV) is operating.

If the vehicle is in the ready mode and the gear is not in P (Park), the V ESS will operate.

When the gear is shifted to R (Reverse), an additional warning sound will be heard.

WARNING

The sound system only plays a supplementary role. The system is not designed to and does not replace the care of drivers. Drivers should always

pay attention to their surroundings while driving.

⚠ CAUTION

- The vehicle does not generate an engine sound. Be aware of your driving environment and drive safely.
- After you park the vehicle or while you are waiting at a traffic light, check whether there are children or obstacles around the vehicle.
- Check if there is something behind the vehicle when driving in reverse. Pedestrians may not hear the sound of the vehicle.

Distance to empty

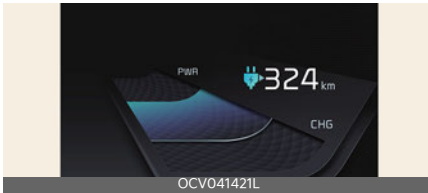

The distance to empty is displayed differently according to the selected drive mode in the Drive Mode Integrated Control System.

For more information, refer to "Drive mode integrated control system" on page 6-32.

When destination is not set

- On average, a vehicle can drive about 330 km (Standard type, 300 km for 4WD)/440 km (Extended type, 400 km for 4WD).
- Under certain circumstances where the air conditioner/heater is ON, the distance to empty is impacted, resulting in a possible distance range from 200~460 km (Standard type)/260~610 km (Extended type). When

using the heater during cold weather or driving at high speed, the high voltage battery consumes a lot more electricity. This may reduce the distance to empty significantly.

- After '0 km' has been displayed, charge the vehicle immediately. The vehicle can drive an additional 3~8 km (2~5 miles) depending on driving speed, heater/air conditioner, weather, driving style, and other factors. Drive your vehicle for approximately 50 km/h (30 mph) to the nearest charging station.
- Distance to empty that is displayed on the instrument cluster after completing a recharge may vary significantly depending on previous operating patterns.

When previous driving patterns include high speed driving, resulting in the high voltage battery using more electricity than usual, the estimated distance to empty is reduced. When the high voltage battery uses little electricity in **ECO** mode, the estimated distance to empty increases.

- Distance to empty may depend on many factors such as the charge amount of the high voltage battery, weather, temperature, durability of the battery, geographical features, and driving style.
- Natural degradation may occur with the high voltage battery depending on the number of years the vehicle is used. This may reduce the distance to empty.

When destination is set

When the destination is set, the distance to empty may change. The distance to empty is recalculated using the information of the destination. However, the dis-

tance to empty may vary significantly based on traffic conditions, driving habits, and condition of the vehicle.

Tips for improving Distance to empty

- If you operate the air conditioner/ heater too much, the driving battery uses too much electricity. This may reduce the distance to empty. Therefore, it is recommended that you set the cabin temperature to 22 °C (72 °F) **AUTO**. This setting that has been certified by various assessment tests to maintain optimal energy consumption rates while maintaining a comfortable temperature. Turn off the heater and air conditioner if you do not need them. However, continuously turning it on and off is not recommended.
- When the heater or air conditioning system is on the energy consumption is reduced if recirculation mode is selected instead of selecting the fresh mode. The fresh mode requires large amount of energy consumption as the outside air has to be re-heated or cooled.
- When using the heater or air conditioning system, use the **DRIVER ONLY** or scheduled air conditioner/ heater function.
- Depress and hold the accelerator pedal to maintain speed and drive economically.
- Gradually depress and release the accelerator pedal when accelerating or decelerating.
- Always maintain specified tire pressures.
- Do not use unnecessary electrical components while driving.

- Do not load unnecessary items in the vehicle.
- Do not mount parts that may increase air resistance.

ECO driving



A: Electric Vehicle

1 ECO driving

In order to check the ECO driving history, select Menu → **ECO driving** on the screen.

Electric energy economy history



A: ECO driving

1 EV Economy

It is possible to check the history of electric energy economy with the date and distance of previous driving. The icon is displayed on the most efficient electric energy economy record.

Energy consumption

In order to check the current energy consumption for each system of the vehicle, select Menu → **Energy consumption** on the screen.



OCV041424L

A: Electric Vehicle

1 Energy consumption

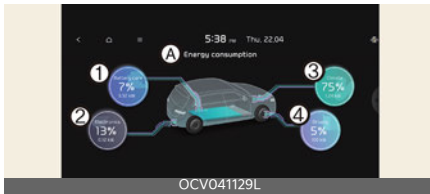

OCV041129L

A: Energy consumption

- 1 Battery care
- 2 Electronics
- 3 Climate
- 4 Driving

1. **Battery care** shows the momentary power and energy consumption which are used when:
 - Operating the winter mode to increase the battery temperature during winter to improve the driving performance.
 - Cooling down the battery temperature during summer to prevent over temperature of the battery.
2. **Electronics** shows the power and energy consumption which are used by the vehicle systems including the cluster, infotainment system (speaker and navigation), headlamp, vehicle control unit, etc.
3. **Climate** shows the power and energy consumption which are used by the heater or air conditioner.
4. **Driving** shows the total power and energy consumption of the driving

motor's driving energy and regenerative energy.

Power/Charge gauge



OCV041130L

The Power/Charge Gauge shows the energy consumption rate of the vehicle and the charge/discharge status of the regenerative brakes.

- **Power PWR:** It shows the energy consumption rate of the vehicle when driving uphill or accelerating. The more electric energy is used, the higher the gauge level.
- **Charge CHG:** It shows the charging status of the battery when it is being charged by the regenerative brakes (decelerating or driving on a downhill road). The more electric energy is charged, the lower the gauge level.

State of charge (SOC) gauge for high voltage battery

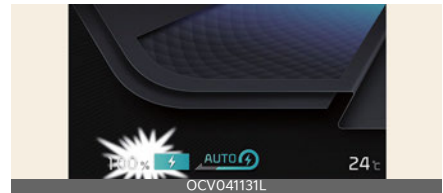

OCV041131L

The SOC gauge shows the charging status of the high voltage battery.

The low percentage number on the indicator indicates that there is not enough energy in the high voltage battery. 100% indicates that the driving battery is fully charged.

When driving on highways or motorways, make sure to check in advance if the driving battery is charged enough.



When the remaining battery is lower than 10% on the SOC gauge, the warning light (🔋) turns ON to alert you of the battery level.

When the warning light (🔋) turns ON, the vehicle can drive an additional 30~40 km (18~25 miles) depending on the driving speed, heater/air conditioner, weather, driving style, and other factors. Charging is required.

*** NOTICE**

When the available vehicle range is below 40~50 km (25~30 miles), the vehicle speed is limited and then eventually the vehicle will turn OFF. Charge the vehicle immediately.

Warning and indicator lights (related to electric vehicle)

Ready indicator READY

- This indicator illuminates:
 - When the vehicle is ready to be driven.
 - ON: Normal driving is possible.
 - OFF: Normal driving is not possible, or a problem has occurred.
 - Blinking: Emergency driving.

When the ready indicator goes OFF or blinks, there is a problem with the system. In this case, we recommend to visit an authorized Kia dealer/service partner.

Service warning light 🛠️

This warning light illuminates:

- When the EV button is in the ON position.
 - It illuminates for approximately 3 seconds and then goes off.
- When there is a problem with related parts of the electric vehicle control system, such as sensors, etc.

When the warning light illuminates while driving, or does not go OFF after starting the vehicle, we recommend to visit an authorized Kia dealer/service partner.

Power down indicator light ⚡

This indicator light illuminates:

- When the EV button is in the ON position.
 - It illuminates for approximately 3 seconds and then goes off.
- When the power is limited for the safety of the high-powered parts of an electric vehicle. The power is limited for the following reasons.(Unless both Service Warning Light and Power Down Indicator Light illuminate at the same time, it is not a failure.)
 - The high voltage battery level is too low or voltage is decreasing
 - The temperature of the high voltage battery is too high or too low
 - The temperature of the motor is high

* NOTICE

- Do not accelerate or start the vehicle suddenly when the power down indicator light is ON.
- When the power is limited for the safety of the high-powered parts of an electric vehicle, the power down indicator light illuminates. Your vehicle may not be driven, or may roll back on a slope with the indicator light ON.

Charging indicator light

This warning light illuminates:

- When the charging connector is connected to charge the high voltage battery.

High voltage battery level warning light

This warning light illuminates:

- When the high voltage battery level is low.
- When the warning light turns ON, charge the battery immediately.

Regenerative brake warning light (red color) (yellow color)

This warning light illuminates:

- When the regenerative brake does not operate and the brake does not perform well. This causes the Brake Warning light (red) and Regenerative Brake Warning Light (yellow) to illuminate simultaneously.

In this case, drive safely and we recommend that you have your vehicle inspected by an authorized Kia dealer/service partner.

The operation of the brake pedal may be more difficult than normal and the braking distance can increase.

LCD display messages

Shift to P to charge

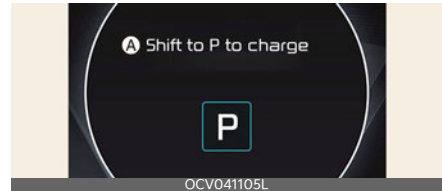

A: Shift to P to charge

This message is displayed if you connect the charging cable without the gear in the P (Park) position.

Shift to P (Park) before connecting the charging cable.

Low EV battery

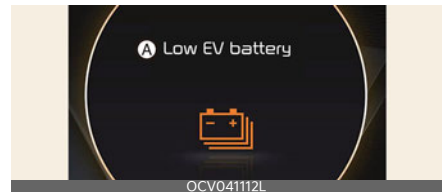

A: Low EV battery

When the high voltage battery level reaches around 10% or less, this warning message is displayed.

The warning light on the instrument cluster () will turn on simultaneously. Charge the battery immediately.

Charge immediately. Power limited



A: Charge immediately. Power limited

When the high voltage battery level reaches around 5% or less, this warning message is displayed.

The warning light on the instrument cluster (⚠️) and the power down indicator light (🔌) will turn on simultaneously. The vehicle's power will be reduced to minimize the energy consumption of the high voltage battery. Charge the battery immediately.

Check electric vehicle system

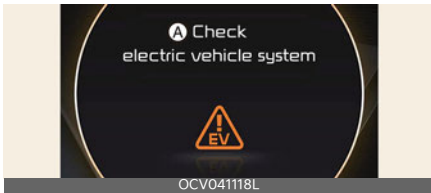

A: Check electric vehicle system

This warning message is displayed when there is a problem with the electric vehicle control system.

⚠️ WARNING

Refrain from driving when the warning message is displayed.

If this occurs, park the vehicle in a safe location and we recommend that you tow your vehicle to the nearest authorized Kia dealer/service partner and have the vehicle inspected.

Power limited

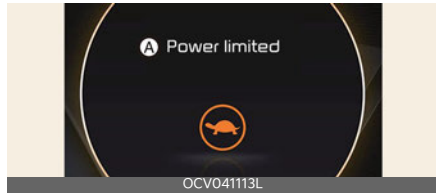

A: Power limited

In the following cases, this warning message is displayed when the vehicle's power is limited for safety.

- When the power is limited for the safety of the high-powered parts of an electric vehicle. The power is limited for the following reasons. (Unless both Service Warning Light and Power Down Indicator Light illuminate at the same time, it is not a failure.)
- The high voltage battery level is too low or voltage is decreasing.
- The temperature of the high voltage battery is too high or too low.
- The temperature of the motor is high.

⚠️ WARNING

When this warning message is displayed, do not accelerate or start the vehicle suddenly. Charge the battery immediately when the high voltage battery level is not enough.

* NOTICE

When the power is limited for the safety of the high-powered parts of an electric vehicle, the power down indicator light illuminates. Your vehicle may not be driven, or may roll back on a slope with the indicator light ON.

Power limited due to low EV battery temperature. Charge battery

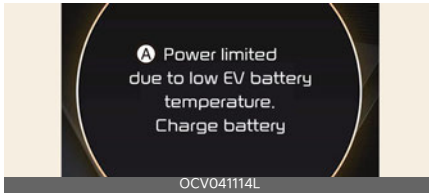

A: Power limited due to low EV battery temperature. Charge battery

The warning message is displayed to protect the electric vehicle system when you turn off or turn on the vehicle while outside temperature is low. If the high voltage battery charging level is low and parked outside in low temperature for a long time, vehicle power could be limited. Charging the battery before driving, increases the battery temperature, and helps increase power.

CAUTION

If this warning message is still displayed even when the ambient temperature is sufficiently high, have the vehicle inspected by an authorized Kia dealer/service partner.

EV Battery Overheated! Stop vehicle

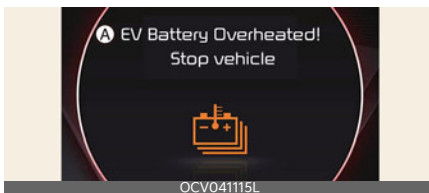

A: EV Battery Overheated! Stop vehicle

This warning message is displayed to protect battery and electric vehicle sys-

tem when the high voltage battery temperature is too high.

Turn off the EV button and stop the vehicle so that the battery temperature decreases.

WARNING

If this warning is still displayed even after the POWER button has been turned off for sufficient time, refrain from driving and have the vehicle inspected by an authorized Kia dealer/service partner.

Stop vehicle and check power supply



A: Stop vehicle and check power supply

This warning message is displayed when a failure occurs in the 12 V power supply system.

If this occurs, park the vehicle in a safe location and we recommend that you tow your vehicle to the nearest authorized Kia dealer/service partner and have the vehicle inspected.

Unplug vehicle to start



A: Unplug vehicle to start

This message is displayed when you start the vehicle, without unplugging the charging cable, and will not shift out of park. Unplug the charging cable, and then turn on the vehicle.

Charging Door Open

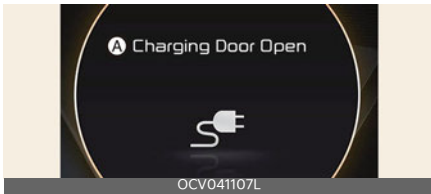

A: Charging Door Open

This message is displayed when the vehicle is driven with the charging door opened. Close the charging door and then start driving.

Remaining Time



A: Remaining Time

* The remaining charging time in the LCD image may differ from actual charging time.

This message is displayed to notify the remaining time to charge the battery, to the selected target battery charge level, and the charge voltage level.

Charging Stopped. Check the AC charger/Charging Stopped. Check the DC charger

AC Charge

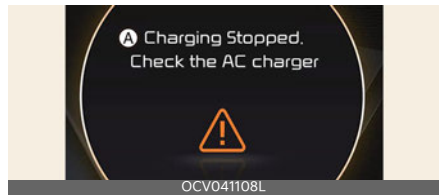

A: Charging Stopped. Check the AC charger

DC Charge

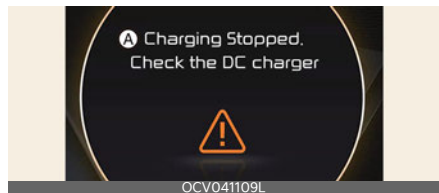

A: Charging Stopped. Check the DC charger

This warning message is displayed when charging is stopped for the reasons below:

- There is a problem with the external AC charger or DC charger.
- The external AC charger stopped charging
- The charging cable is damaged.

If this occurs, check whether there is any problem with the external AC or DC charger and charging cable.

If the same problem occurs when charging the vehicle with a well-functioning external charger or genuine Kia

portable charger, have your vehicle inspected by an authorized Kia dealer/service partner.

Charging Stopped. Check the cable connection

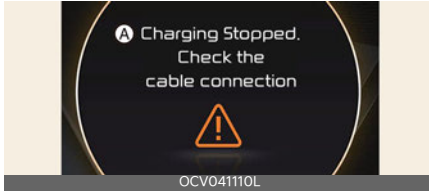

A: Charging Stopped. Check the cable connection

This warning message is displayed for the reasons below:

- The charging connector is not correctly connected to the charging inlet.
- The charging connector lock release button is pressed.

If this occurs, separate the charging connector and re-connect it.

Check whether there is any problem (external damage, foreign substances, etc.) with the charging connector and charging inlet.

If the same problem occurs when charging the vehicle with a replaced charging cable or genuine Kia portable charger, we recommend that you have your vehicle inspected by an authorized Kia dealer/service partner.

Check regenerative brakes

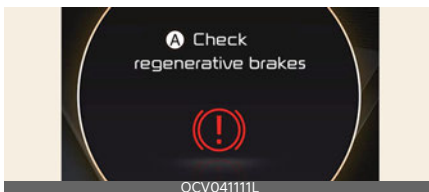

A: Check regenerative brakes

This warning message is displayed when the regenerative brake system does not work properly.

In this case, we recommend to visit an authorized Kia dealer/service partner.

Check Virtual Engine Sound System

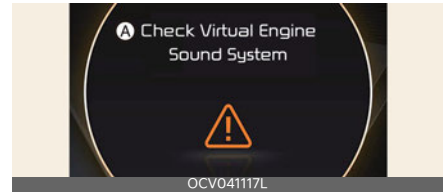

A: Check Virtual Engine Sound System

This message is displayed when there is a problem with the Virtual Engine Sound System (VESS).

In this case, we recommend to visit an authorized Kia dealer/service partner.

Check Active Air Flap System



A: Check Active Air Flap System

This warning message is displayed in the following situations:

- There is a malfunction with the actuator flap
- There is a malfunction with the actuator air flap controller
- The air flap does not open

When all of the above conditions are fixed, the warning will disappear.

Refill coolant



A: Refill coolant

This message is displayed when the coolant is low. If the warning message is displayed, stop driving and check the amount of coolant. Driving under coolant for a prolonged period of time can cause serious problems with the vehicle's electrical equipment and make normal driving impossible.

Safety precautions for electric vehicle

If an accident occurs

If towing is required, tow the vehicle with a flatbed equipment or dollies with all wheels off the ground.

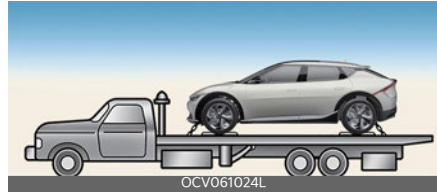

If you must tow the vehicle using only two wheels, lift the rear wheels off the ground and tow the vehicle.

If necessary to roll the vehicle so that it can be rolled onto a flatbed tow truck perform the following:

- First, depress the brake pedal and release the parking brake.
- Wait 3 minutes or more before opening the driver door and the vehicle will remain in ACC mode and in N (Neutral).
- If the driver door is opened within the 3 minute period, the vehicle will automatically shift to P (Park), the vehicle will turn OFF and the front wheels will be remained locked.

High voltage cut-off switch



Pull down the yellow lever in the high voltage cut-off switch to shut down high voltage battery.

Other precautions for electric vehicle

- When you paint, apply heat treatment to the vehicle as a result of an accident, and/or weld on the vehicle, the performance of the high voltage battery can be reduced. If heat treatment is required, have the vehicle serviced by an authorized Kia dealer/service partner and have the HV battery removed, prior to any repairs.

WARNING

- When a vehicle accident occurs, move the vehicle to a safe place, turn OFF the vehicle and remove the auxiliary battery (12 V) terminal to prevent high voltage electricity from flowing.
- If electric wires are exposed from inside or outside the vehicle, do not touch the wires. Also, do not touch the high voltage electric wire (orange), connector, or any of the electric components and devices. This may cause electric shock and lead to injuries.
- When a vehicle accident occurs and the high voltage battery is damaged, harmful gas and electrolytes may leak. Be careful not to touch the leaked liquid.

When you suspect leakage of inflammable gas and other harmful gases, open the windows and evacuate to a safe place. If any leaked fluid comes in contact with your eyes or skin, immediately clean the affected area thoroughly with tap water or saline solution and have doctors inspect it as soon as possible.

- If a small scale fire occurs, use a fire extinguisher (ABC, BC) that is meant for electrical fires. If it is impossible to extinguish the fire in the early stage, maintain a safe distance away from the vehicle and immediately call your local fire emergency responders. Also, advise them that an electric vehicle is involved.

If the fire spreads to the high voltage battery, large amounts of water is needed to put out the fire. Using small amounts of water or fire extinguishers not meant for electrical fires could cause serious injury or death from electrical shocks.

- If you cannot put out the fire immediately, the high voltage battery may explode. Evacuate to a safe place and do not let other people approach the site. Contact the fire department and notify them of an electric vehicle fire. If the vehicle is flooded with water, immediately turn OFF the vehicle and evacuate to a safe place. Contact the fire department or an authorized Kia dealer/service partner.
- If you tow the vehicle while the front wheels are touching the ground, the vehicle motor may generate electricity and the motor components may be damaged or a fire may occur.



- When a vehicle fire occurs due to the battery, there is a risk of a second fire. Contact your local fire emergency responders when towing the vehicle.
- When you clean the motor compartment, do not use high pressure water to wash. This may cause an electric shock due to a discharge in high voltage electricity, or damage the vehicle's electric system.
- Never disconnect the high voltage cut-off switch except in an emergency situation. Serious problems may occur, such as the vehicle will not start.

⚠ CAUTION

- Do not use, remodel, or install non-genuine parts. This may damage the electric power system.
- The 4WD vehicle should never be towed with the wheels on the ground. This can cause serious damage to the transmission or the 4WD system.

*** NOTICE**

Putting the excessive force to the switch lever while shutting down the high voltage battery may severely damage the high voltage cut-off switch.

Your vehicle at a glance **3**

Exterior overview	3-2
Interior overview	3-4
Instrument panel overview	3-7
Motor room compartment.....	3-10

Your vehicle at a glance

Exterior overview

Front view



OCV011001L

* The actual features in your vehicle may not necessarily be available due to the selected options or regions.

- | | |
|----------------------------------|--------------|
| 1. Hood | 5-32 |
| 2. Head lamp | 5-62, 8-34 |
| 3. Wheel and tire | 8-15, 9-4 |
| 4. Outside rear view mirror | 5-42 |
| 5. Wide sunroof | 5-36 |
| 6. Front windshield wiper blades | 5-68, 8-12 |
| 7. Windows | 5-30 |
| 8. Front ultrasonic sensor | 6-148, 6-159 |
| 9. Front radar | 6-38 |
| 10. Front view camera | 6-38 |

Rear view



OCV011002L

* The actual features in your vehicle may not necessarily be available due to the selected options or regions.

1. Doors	5-11
2. Charging door	5-34
3. Rear combination lamp	8-35
4. High mounted stop lamp	8-35
5. Tailgate	5-20
6. Antenna	5-96
7. Rear view camera	6-130, 6-133
8. Rear ultrasonic sensor	6-145, 6-159
9. Backup lamp	8-35
10. Rear fog lamp	8-35

Interior overview

Left-hand drive

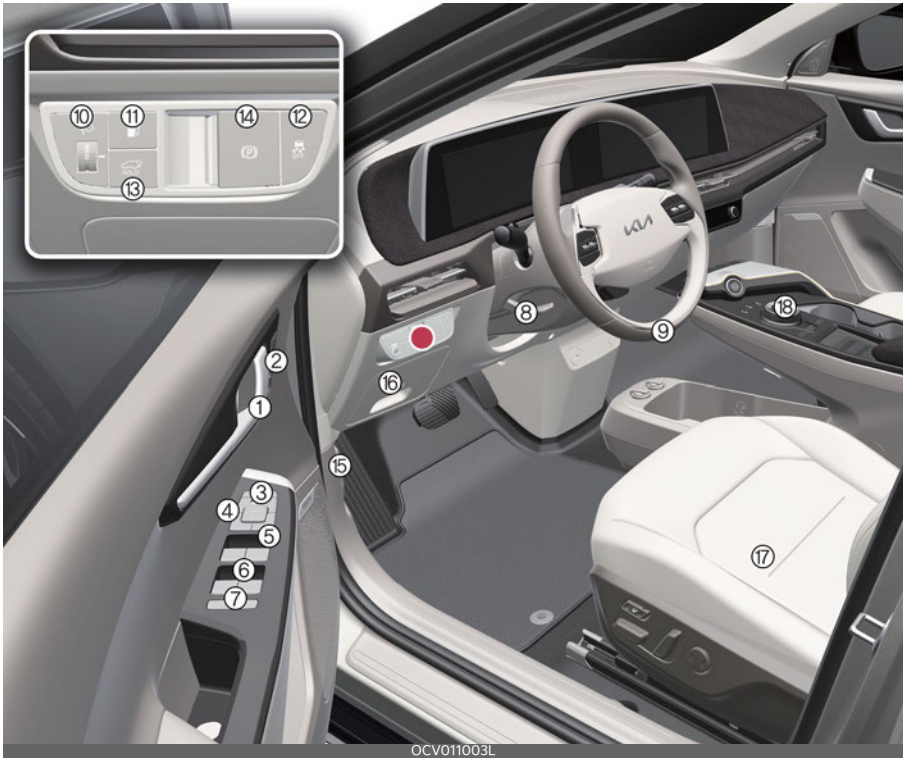

Right-hand drive



3

* The actual features in your vehicle may not necessarily be available due to the selected options or regions.

- | | |
|--|------------|
| 1. Inside door handle | 5-13 |
| 2. Driver position memory system | 5-19 |
| 3. Outside rearview mirror folding switch | 5-43 |
| 4. Outside rearview mirror control switch | 5-42 |
| 5. Central door lock/unlock switch | 5-13 |
| 6. Power window switches | 5-30 |
| 7. Power window lock/Electronic power child safety lock button | 5-16, 5-30 |
| 8. Steering wheel tilt/telescopic lever | 5-39 |
| 9. Steering wheel | 5-39 |
| 10. Headlamp leveling adjustment switch | 5-68 |
| 11. Charging door open/close button | 5-34 |
| 12. ESC OFF button | 6-28 |
| 13. Power tailgate open/close button | 5-21 |

14.EPB switch	6-24
15.Hood release lever	5-32
16.Instrument panel fuse	8-23
17.Seat	4-3
18.Reduction gear (shifter dial)	6-10

Instrument panel overview

Left-hand drive



3

Right-hand drive



OCV011004R_2

* The actual features in your vehicle may not necessarily be available due to the selected options or regions.

- | | |
|--|------------|
| 1. Audio remote control button | 5-96 |
| 2. Driver's front air bag | 4-36 |
| 3. Horn | 5-40 |
| 4. Driving Assist button | 6-95, 6-98 |
| 5. Instrument cluster | 5-45 |
| 6. Light control/turn signals lever Wiper and washer control lever | 5-62, 5-68 |
| 7. EV button | 6-8 |
| 8. Infotainment system | 5-95 |
| 9. Hazard warning flasher switch | 7-2 |
| 10. Infotainment/climate switchable controller | 5-95 |
| 11. Front seat warmer and air ventilation seat button | 5-89 |
| 12. Glove box | 5-86 |
| 13. Steering wheel heater button | 5-39 |

14.AUTO HOLD button	6-27
15.Parking/View button	6-130, 6-133, 6-159
16.Parking Safety button	6-148, 6-159
17.Wireless charging system	5-93
18.Center console storage box	5-86
19.Passenger's front air bag	4-36

Motor room compartment

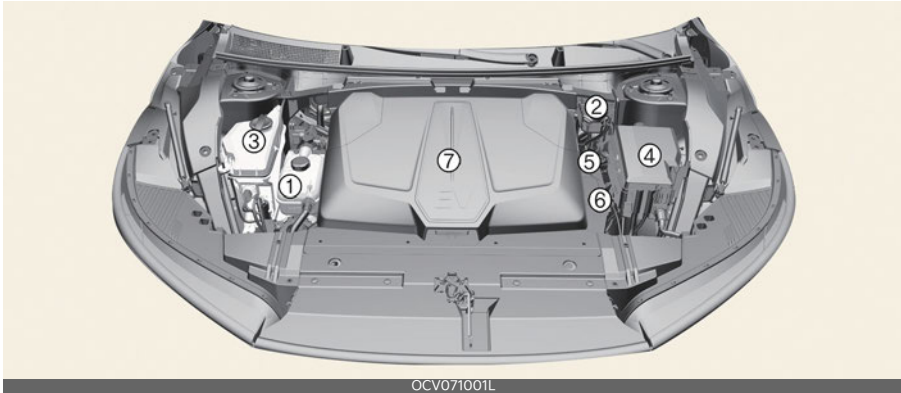

* The actual motor compartment in the vehicle may differ from the illustration.

- | | |
|---|------|
| 1. Coolant reservoir | 8-9 |
| 2. Brake fluid reservoir | 8-9 |
| * This part is located on the opposite side for Right-hand drive vehicle. | |
| 3. Windshield washer fluid reservoir | 8-10 |
| 4. Fuse box | 8-22 |
| 5. Negative battery terminal (-) | 8-13 |
| 6. Positive battery terminal (+) | 8-13 |
| 7. Front trunk | 5-33 |

Seat	4-3
• Infotainment system.....	4-4
• Adjusting the front seat.....	4-4
• Seatback pocket.....	4-6
• Adjusting the rear seat	4-8
Headrest	4-10
• Adjusting the headrest	4-10
• Removing/reinstalling the headrest	4-10
Armrest	4-11
• Adjusting the armrest.....	4-11
• Carrying long/narrow cargo.....	4-11
Seat belts	4-12
• Seat belt restraint system.....	4-13
• Seat belt precautions.....	4-18
• Care of seat belts	4-20
Child restraint system (CRS)	4-21
• Our recommendation: Children always in the rear	4-21
• Selecting a Child Restraint System (CRS)	4-21
• Installing a Child Restraint System (CRS).....	4-23
ISOFIX anchorage and top-tether anchorage (ISOFIX Anchorage System) for children	4-23
• Securing a Child Restraint System with the "ISOFIX Anchorage" system	4-24
• Securing a Child Restraint System with the "Top-tether Anchorage" system.....	4-24
• Securing a Child Restraint System with a lap/shoulder belt.....	4-25
• Suitability of each seating position for belted & ISOFIX Child Restraint Systems (CRS) according to UN regulations (Information for use by vehicle users and CRS manufacturers).....	4-26
• Recommended CRS for Vehicle according to UN regulations ..	4-27

4 Safety features of your vehicle

Air bag - supplemental restraint system	4-28
• Air bag warning and indicator light	4-31
• SRS components and functions	4-34
• Driver's and passenger's front air bags	4-36
• Side air bag and front center air bag.....	4-37
• Curtain air bag	4-38
• Air bag collision sensors	4-40
• Air bag inflation conditions.....	4-41
• Air bag non-inflation conditions.....	4-42
• SRS care	4-44
• Additional safety precautions.....	4-45
• Adding equipment to or modifying your air bag-equipped vehicle.....	4-45
• Air bag warning labels.....	4-46

Safety features of your vehicle

Seat

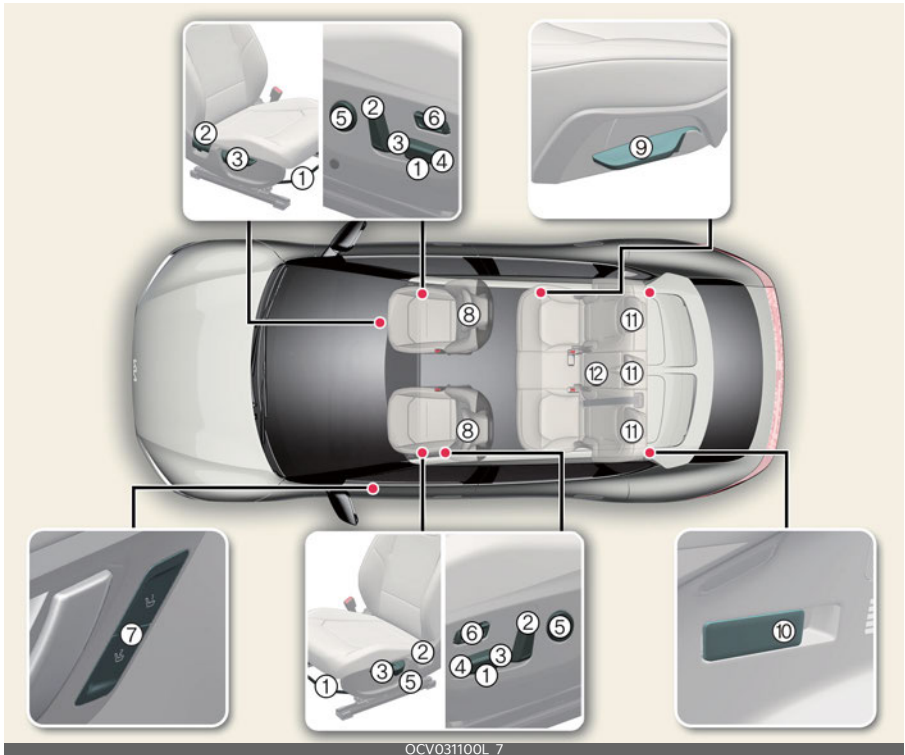

OCV031100L_7

* The actual features in your vehicle may not necessarily be available due to the selected options or regions.

* The picture above is based on LHD vehicle. For RHD vehicle, the operation of front seat are located on the opposite side.

Front seat

- 1 Forward and backward
- 2 Seatback angle
- 3 Seat cushion height
- 4 Seat cushion tilt
- 5 Lumbar support
- 6 Relaxion comfort seat
- 7 Driver position memory system
- 8 Headrest

2nd-row seat

- 9 Seatback angle/folding
- 10 Seatback folding
- 11 Headrest
- 12 Armrest

Infotainment system

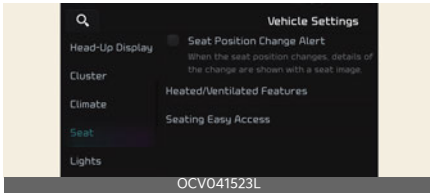

Select **Settings** → **Vehicle** → **Seat** from the Settings menu in the infotainment system screen, you may use various convenience functions.

- **Seat position change alert:** When the seat position changes, details of the change are shown with a seat image.
- **Heating/Ventilation**
 - **Auto. Controls That Use Climate Control Settings** (for driver's seat): The seat temperature is automatically controlled.
- **Seat Easy Access**
 - **Steering easy access:** Moves the steering wheel when the driver enters or leaves the vehicle.
 - **Easy seat (fwd/bwd) access (Normal/Extended/Off)** the seat automatically moves when the driver enters or leaves the vehicle may be selected.

For detailed information, refer to Navigation Quick Reference Guide.

* The information provided may differ according to which functions are applicable to your vehicle.

Adjusting the front seat

Operation

- The seat can be adjusted using the control levers located on the outside of the seat cushion.

* INFORMATION

Adjust the seat before driving, and make sure the seat is locked securely by trying to move without using the lever. If the seat moves, it is not locked properly.

Manual seat



- 1 Forward/backward
- 2 Seatback angle
- 3 Cushion height

Power seat (if equipped)



- 1 Forward/backward
- 2 Seatback angle
- 3 Cushion height
- 4 Cushion tilt

Lumbar support (if equipped)



- 1 Increase support
- 2 Decrease support

* NOTICE

Do not continue to operate the lumbar support when the lumbar support provides its maximum support. Damage to the lumbar support motor could occur.

Relaxion comfort seat (for front seats) (if equipped)



Relaxion comfort seats distribute body pressure and concentrated weight on specific body parts that occur while sitting in the same position for a long period of time. The seat relieves fatigue and discomfort by providing the optimal sit position.

⚠ CAUTION

Take the following precautions when using the relaxion comfort seat:

- Do not use the relaxion comfort seat while the vehicle is moving. Using the comfort seat could increase the risk of injuries in the event of a collision or sudden stop.
- Do not use the relaxion comfort seat while the vehicle is moving. The shoulder belt may not adhere to your chest firmly.
- Do not use the relaxion comfort seat when the luggage or other objects are placed at the rear seat.
- Do not use the relaxion comfort seat when the rear seats are not in the rearmost position and upright.

Operating relaxion comfort seat



Operation

1. Press the rear portion of the switch (A) more than 1 second.
2. An alarm appears on the infotainment screen.
3. Press the switch (A) again for more than 1 seconds within 5 seconds.
4. If the seat adjustment switch (reclining, cushion height) is operated during relaxion comfort seat operation, the operation will stop.
5. After the operation is complete, it can be adjusted more using the seat

adjustment switch for a more comfortable posture.



Operating condition(s)

- Driver's seat
 - Power button is ACC, ON, START/RUN position
 - P (Park) gear position is selected.
 - Driver's side rear seat seatbelt is not fastened
- Passenger's seat
 - Power button is ACC, ON, START/RUN position
 - Passenger's side rear seat seatbelt is not fastened

Returning relaxation comfort seat

Operation

If you press the front portion of the switch (A) more than 1 second while the seat is in the relaxation comfort seat position, the seat return backs to the original position.

* NOTICE

When relaxation comfort seat cannot be operated, try to reset Integrated Memory System. If relaxation comfort seat does not operate even after Integrated Memory System is reset, it is recommended that you contact an authorized Kia dealer/service partner.

Seatback pocket



- 1 Seatback pocket
- 2 USB charger

⚠ WARNING

- Loose objects in the driver's foot area could interfere with the operation of the foot pedals, possibly causing an accident.
- When you return the seatback to its upright position, hold the seatback and return it slowly and be sure there are no other occupants around the seat. If the seatback is returned without being held and controlled, the back of the seat could spring forward resulting in accidental injury to a person struck by the seatback.
- Riding in a vehicle with the seatback reclined could lead to serious or fatal injury in an accident.
- If a seat is reclined during an accident, the occupant's hips may slide under the lap portion of the seatbelt, applying great force to the unprotected abdomen. Serious or fatal internal injuries could result. The driver must advise the passenger to keep the seatback in an upright position whenever the vehicle is in motion.
- Do not use a sitting cushion that reduces friction between the seat and passenger. The passenger's hips may slide under the lap portion of the seat belt during an accident or a sudden stop. Serious or fatal internal injuries

could result because the seat belt can't operate normally.

- Never attempt to adjust any seat while the vehicle is moving. This could result in loss of control, and an accident causing death, serious injury, or property damage.
- Do not allow anything to interfere with the normal position of the seatback. Storing items against a seatback or in any other way interfering with proper locking of a seatback could result in serious or fatal injury in a sudden stop or collision.
- Always drive and ride with your seatback upright and the lap portion of the seat belt snug and low across the hips. This is the best position to protect you in case of an accident.
- In order to avoid unnecessary and perhaps severe air bag injuries, always sit as far back as possible from the steering wheel while maintaining comfortable control of the vehicle. We recommend that your chest is at least 250 mm (10 inches) away from the steering wheel.
- The rear seatback must be securely latched. If not, passengers and objects could be thrown forward resulting in serious injury or death in the event of a sudden stop or collision.
- Luggage and other cargo should be laid flat in the cargo area. If objects are large, heavy, or must be piled, they must be secured. Under no circumstances should cargo be piled higher than the seatbacks. Failure to follow these warnings could result in serious injury or death in the event of a sudden stop, collision or rollover.
- No passenger should ride in the cargo area or sit or lie on folded seatbacks while the vehicle is moving. All passengers must be properly seated in seats and restrained properly while riding.
- When resetting the seatback to the upright position, make sure it is securely latched by pushing it forward and backwards.
- After adjusting the seat, always check that it is securely locked into place by attempting to move the seat forward or backward without using the lock release lever. Sudden or unexpected movement of the driver's seat could cause you to lose control of the vehicle resulting in an accident.
- Do not adjust the seat while wearing seat belts. Moving the seat cushion forward may cause strong pressure on the abdomen.
- Use extreme caution so that hands or other objects are not caught in the seat mechanisms while the seat is moving.
- Do not put a cigarette lighter on the floor or seat. When you operate the seat, gas may gush out of the lighter and cause fire.
- If there are occupants in the rear seats, be careful while adjusting the front seat position.
- Use extreme caution when picking small objects trapped under the seats or between the seat and the center console. Your hands might be cut or injured by the sharp edges of the seat mechanism.
- The power seat is operable with the EV button in OFF position. Therefore, children should never be left unattended in the car.

CAUTION

- The power seat is driven by an electric motor. Stop operating once the adjustment is completed. Excessive operation may damage the electrical equipment.
- When in operation, the power seat consumes a large amount of electrical power. To prevent unnecessary charging system drain, don't adjust the power seat longer than necessary while the vehicle is not running.
- Do not operate two or more power seat control switches at the same time. Doing so may result in power seat motor or electrical component malfunction.

Adjusting the rear seat

Adjusting rear seatback angle

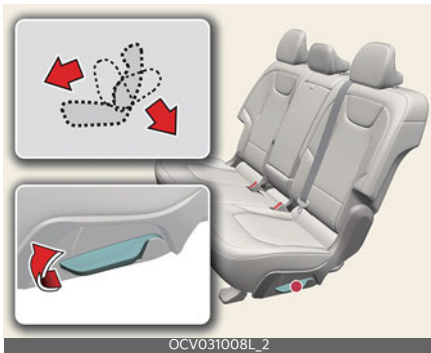

Operation

1. Pull up the seatback recline lever.
2. Hold the lever and adjust the seatback of the seat to the position you desire.
 - Release the lever and make sure the seatback is locked in place. (The lever MUST return to its origi-

nal position for the seatback to lock.)

Folding rear seatback

Type A



Type B



1 Left side seatback

- For type A, pull up the seatback folding lever, then fold the seat down.
- For type B, pull the seatback folding lever (1) and (2).

2 Right side seatback

Operation

Insert the seat belt buckle/webbing in the pocket/guide.

⚠ WARNING

- Never attempt to adjust while the vehicle is moving or the rear seat is occupied as the seat may suddenly move and cause the passenger on the seat to be injured.
- The purpose of the fold-down rear seatbacks is to allow you to carry longer objects that could not be accommodated in the cargo area. Never allow passengers to sit on top of the folded down seatback while the vehicle is moving. This is not a proper seating position and no seat belts are available for use. This could result in serious injury or death in case of an accident or sudden stop. Objects carried on the folded down seatback should not extend higher than the top of the front seatbacks. This could allow cargo to slide forward and cause injury or damage during sudden stops.
- Do not fold the rear seats, if passengers, pets or luggage are in the rear seats. It may cause injury or damage to passengers, pets or luggage.
- When you return the seatback to its upright position, hold the seatback and return it slowly. If the seatback is returned without holding it, the back of the seat could spring forward resulting in injury caused by being struck by the seatback.
- Cargo should always be secured to prevent it from being thrown about the vehicle in a collision and causing injury to the vehicle occupants. Do not place objects in the rear seats, since they cannot be properly secured and may hit the front seat occupants in a collision.
- Make sure the EV button is in OFF position, P (Park) gear position is selected, and the parking brake is securely applied whenever loading or unloading cargo. Failure to take these steps may allow the vehicle to move if the shift lever is inadvertently moved to another position.
- Never attempt to adjust while the vehicle is moving or the rear seat is occupied as the seat may suddenly move and cause the passenger on the seat to be injured.

⚠ CAUTION

- Do not allow your hands or fingers to get caught in the seat mechanisms while adjusting the seats.
- When returning the rear seatbacks to the upright position, remember to return the rear shoulder belts to their proper position. Routing the seat belt webbing through the rear seat belt guides will help keep the belts from being trapped behind or under the seats.
- When you fold the rear seatback, insert the buckle in the pocket between the rear seatback and cushion. Doing so can prevent the buckle from being damaged by the rear seatback.

Headrest

The seats are equipped with a headrest for the occupant's safety and comfort.



Adjusting the headrest (if equipped)



Operation

- Pull up the headrest to raise it.
- Push and hold the release button (1) to lower the headrest.

Adjusting the headrest forward and backward (if equipped)



Operation

- Pull the headrest fully forward and release it.

* INFORMATION

The headrest may be adjusted forward to 3 different positions by pulling the headrest forward.

Removing/reinstalling the headrest



Operation

1. Recline the seatback.
2. Raise headrest as far as it can go.
3. Push and hold the release button (1) while pulling the headrest up.
4. Install in the reverse order of removal.

⚠ WARNING

- For maximum effectiveness in case of an accident, the headrest should be adjusted so the middle of the headrest is at the same height of the center of gravity of an occupant's head. Generally, the center of gravity of most people's head is similar with the height of the top of their eyes. Also, adjust the headrest as close to your head as possible. For this reason, the use of a cushion that holds the body away from the seatback is not recommended.



- Do not operate the vehicle with the headrests removed or reversed as severe injury to the occupants may occur in the event of an accident. Headrests may provide protection against neck injuries when properly adjusted.
- Do not adjust the headrest position of the driver's seat while the vehicle is in motion.
- Make sure the headrest locks in position after adjusting it to properly protect the occupants.
- Never allow anyone to ride in a seat with the headrests removed.
- Always make sure the headrest locks into position after reinstalling and adjusting it properly.

CAUTION

- When there is no occupant in the rear seats, adjust the height of the headrest to the lowest position. The rear seat headrest can reduce the visibility of the rear area.



- If you recline the seatback towards the front with the headrest and seat cushion raised, the headrest may come in contact with the sun visor or other parts of the vehicle.

Armrest

Adjusting the armrest



Operation

- Pull the armrest forward from the seatback.
- Slide the cover outwards to use the cup holder.
- Slide the cover inwards to use the storage area.

Carrying long/narrow cargo (if equipped)



Additional cargo space is provided to accommodate long/narrow cargo (skis, poles, etc.) not able to fit properly in the trunk when closed.

Operation

1. Pull the armrest down.
2. Pull the cover down while pushing the release lever down.

⚠ WARNING

Do not put heavy or sharp objects in the seatback pockets or inside the armrest storage area. In an accident they could come loose from the pocket and injure vehicle occupants.

⚠ CAUTION

- Do not store small or heavy objects. It might fly off and cause injuries.
- When cargo is loaded through the rear passenger seats, ensure the cargo is properly secured to prevent it from moving while driving.

*** NOTICE**

- Be careful when loading cargo through the rear passenger seats to prevent damage to the vehicle interior.
- When both the armrest and the panel, which is located between the rear seatback and the trunk, are folded down, put back the panel first before folding back the armrest. If not, the panel knobs and the armrest knobs may interfere with each other and get damaged.

Seat belts

Seat belts are designed to bear upon the bony structure of the body, and should be worn low across the front of the pelvis, chest and shoulders.

⚠ WARNING

- For maximum restraint system protection, the seat belts must always be used whenever the car is moving.
- Seat belts are most effective when seatbacks are in the upright position.
- Children age 13 and younger must always be properly restrained in the rear seat. Never allow children to ride in the front passenger seat. If a child over 13 must be seated in the front seat, he/she must be properly belted and the seat should be moved as far back as possible.
- Never wear the shoulder belt under your arm or behind your back. An improperly positioned shoulder belt can cause serious injuries in a crash. The shoulder belt should be positioned midway over your shoulder across your collarbone.
- Never wear a seat belt over fragile objects. If there is a sudden stop or impact, the seat belt can damage it.
- Avoid wearing twisted seat belts. A twisted belt can't do its job as well. In a collision, it could even cut into you. Be sure the belt webbing is straight and not twisted.
- Be careful not to damage the belt webbing or hardware. If the belt webbing or hardware is damaged, replace it.
- Seat belts are designed to bear upon the bony structure of the body, and should be worn low across the front of the pelvis or the pelvis, chest and

shoulders, as applicable; wearing the lap section of the belt across the abdominal area must be avoided. Seat belts should be adjusted as firmly as possible, consistent with comfort, to provide the protection for which they have been designed. A slack belt will greatly reduce the protection afforded to the wearer. Care should be taken to avoid contamination of the webbing with polishes, oils and chemicals, and particularly battery acid. Cleaning may safely be carried out using mild soap and water. The belt should be replaced if webbing becomes frayed, contaminated or damaged. It is essential to replace the entire assembly after it has been worn in a severe impact even if damage to the assembly is not obvious. Belts should not be worn with straps twisted. Each belt assembly must only be used by one occupant; it is dangerous to put a belt around a child being carried on the occupant's lap.

- No modifications or additions should be made by the user which will either prevent the seat belt adjusting devices from operating to remove slack, or prevent the seat belt assembly from being adjusted to remove slack.
- When you fasten the seat belt, be careful not to latch the seat belt in buckles of other seat. It's very dangerous and you may not be protected by the seat belt properly.
- Do not unfasten the seat belt and do not fasten and unfasten the seat belt repeatedly while driving. This could result in loss of control, and an accident causing death, serious injury, or property damage.
- When fastening the seat belt, make sure that the seat belt does not pass over objects that are hard or can break easily.
- Make sure there is nothing in the buckle. The seat belt may not be fastened securely.

Seat belt restraint system

Seat belt warning light

Front seat belt warning light

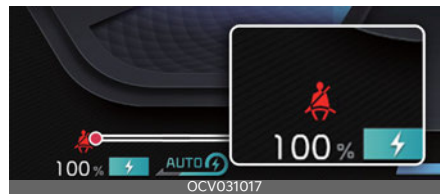

Operating condition(s)

- When the vehicle is running
 - The front seat belt warning light will illuminate for approximately 3~6 seconds.
- When the front seat belt is unfastened
 - For driver's seat, the front seat belt warning chime will sound for approximately 5 seconds. (if equipped)
 - The front seat belt warning light will stay illuminated. (if equipped)
- When the front seat belt is unfastened during driving and the vehicle speed is under approximately 20 km/h (12 mph)
 - The front seat belt warning light will illuminate
- When the vehicle speed is over approximately 20 km/h (12 mph)
 - The warning chime will sound for approximately 100 seconds

- The front seat belt warning light will blink.

Rear passenger seat belt warning lights (if equipped)



- 2nd-row seat: (1) Driver's side, (2) Center, (3) Passenger's side

Operating condition(s)

For Europe

- When the vehicle is running
 - Rear passenger's seat belt warning light will illuminate for approximately 6 seconds.
- When the seat belt is unfastened during driving and the vehicle speed is under approximately 20 km/h (12 mph)
 - Rear passenger's seat belt warning light will stay illuminated.
- When the vehicle speed is over approximately 20 km/h (12 mph)
 - Rear passenger's seat belt warning chime will sound for approximately 35 seconds
 - Rear passenger's seat belt warning light will blink.
- When the vehicle is driven without the seat belt fastened, or the driver has unfastened the seat belt when the vehicle speed is over approximately 20 km/h (12 mph)
 - Rear passenger's seat belt warning chime will sound for approximately 35 seconds

- Rear passenger's seat belt warning light will blink.

Except Europe

- When the vehicle is running
 - Rear passenger's seat belt warning light will illuminate for approximately 6 seconds.
- When the seat belt is unfastened during driving and the vehicle speed is under approximately 20 km/h (12 mph)
 - Rear passenger's seat belt warning light will blink for approximately 70 seconds.
- When the vehicle speed is over approximately 20 km/h (12 mph)
 - Rear passenger's seat belt warning chime will sound for approximately 35 seconds
 - Rear passenger's seat belt warning light will blink.

Non-operating condition(s)

- When the rear door is opened or closed, and the vehicle speed is under 10 km/h (6 mph)
 - Seat belt warning light and the seat belt warning chime will not work even if the vehicle speed is over approximately 20 km/h (12 mph).

⚠ WARNING

Riding in an improper position adversely affects the front seat belt warning system. It is important for the driver to instruct the passenger to properly be seated as instructed in this manual.

*** NOTICE**

- Although the front passenger seat is not occupied, the seat belt warning light will blink or illuminate for 6 seconds.
- The front passenger's seat belt warning may operate when luggage is placed.

Seat belt - 3-point system with emergency locking retractor

Fastening/unfastening the seat belt

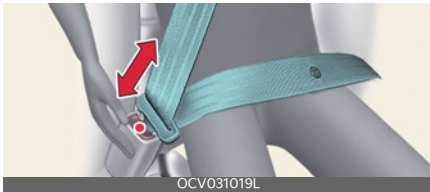

Operation

- Insert the metal tab into the buckle.
- Press the release button in the locking buckle.

*** INFORMATION**

- There will be an audible "click" when the tab locks into the buckle.



- 1 Rear right seat belt fastening buckle
- 2 Rear center seat belt fastening buckle (with the "CENTER" mark)
- 3 Rear left seat belt fastening buckle

Adjusting the height of the shoulder belt



Operation

- Pull the height adjuster up (1).
- Press the height adjuster button (2) and push the height adjuster down (3).

⚠ WARNING

- You should place the lap belt portion as low as possible and snugly across your hips, not on your waist. If the lap belt is located too high on your waist, it may increase the chance of injury in the event of a collision. Both arms should not be under or over the belt. Rather, one should be over and the other under, as shown in the illustration. Never wear the seat belt under the arm near the door.
- Prior to fastening the rear seat belts, ensure the latch matches the seat belt buckle. Forcefully fastening the left or right seat belt to the center buckle can result in an improper fastening scenario that will not protect you in an accident.
- Failure to replace seat belts after an accident could leave you with damaged seat belts that will not provide protection in the event of another collision leading to personal injury or death. Replace your seat belts after being in an accident as soon as possible.

- Verify the shoulder belt anchor is locked into position at the appropriate height. Never position the shoulder belt across your neck or face.

⚠ CAUTION

- Do NOT fold down the left portion of the rear seatback when the rear center seat belt is buckled. ALWAYS UNBUCKLE the rear center seat belt before folding down the left portion of the rear seatback. If the rear center seat belt is buckled when the left portion of the rear seatback is folded down, distortion and damage to the top portion of the seatback and seat belt garnish may result, causing the seatback to lock into the folded down position.
- Do not force to lock the left or right seat belt into the center seat belt buckle. Make sure to lock the rear center seat belt into the center seat belt buckle. If not, the improperly fastened seat belt will not be able to provide protection.
- When pulling out to wear the seat belt, the tongue should be slowly pulled out of the seat belt guide so that the seat belt guide does not come off the trim.

*** NOTICE**

If you are not able to pull out the seat belt from the retractor, firmly pull the belt out and release it. Then you will be able to pull the belt out smoothly.

Seat belt pretensioner

Your vehicle is equipped with front driver and passenger, and rear passengers' (if equipped) Seat belt pretensioners.

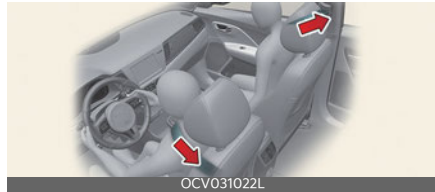

The seat belt pretensioner system consists of the following main components.

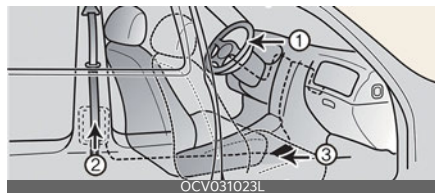

- 1 SRS air bag warning light
- 2 Front retractor pre-tensioner assembly
- 3 SRS control module

Operating condition(s)

- When the vehicle stops suddenly, or if the occupant tries to lean forward too quickly, the seat belt retractor will lock into position.
- In certain frontal collisions, the pretensioner will activate and pull the seat belt into tighter contact against the occupant's body.
- When the system senses excessive tension on the driver or passenger's seat belt when the pre-tensioner system activates, the load limiter inside the retractor pre-tensioner will release some of the pressure on the affected seat belt.

⚠ WARNING

- For your safety, be sure that the belt webbing is not loose or twisted and always sit properly on your seat.
- To obtain maximum benefit from a Seat belt pretensioner:
 1. The seatbelt must be working correctly and adjusted to the proper position. Please read and follow all of the important information and precautions about your vehicle's occupant safety features - including seat belts and air bags - that are provided in this manual.
 2. Be sure you and your passengers always wear seat belts properly.
- Pre-tensioners seat belts systems are designed to operate only one time. After activation, Seat belt pretensioners must be replaced. All seat belts, of any type, should always be replaced after they have been worn during a collision.
- The Seat belt pretensioner assembly mechanisms become hot during activation. Do not touch the Seat belt pretensioner assemblies for several minutes after they have been activated.
- Do not attempt to inspect or replace the Seat belt pretensioners yourself. Have the system inspected by a professional workshop. Kia recommends visiting an authorized Kia dealer/service partner.
- Do not attempt to service or repair the Seat belt pretensioner system in any manner.
- Improper handling of the Seat belt pretensioner assemblies, and failure to heed the warnings not to strike, modify, inspect, replace, service or

repair the Seat belt pretensioner assemblies may lead to improper operation or inadvertent activation and serious injury.

- Always wear the seat belts when driving or riding in a motor vehicle.
- If the vehicle or Seat belt pretensioner must be discarded, contact a professional workshop. Kia recommends visiting an authorized Kia dealer/service partner.
- Body work on the front area of the vehicle may damage the Seat belt pretensioner system. Therefore, have the system serviced by a professional workshop. Kia recommends to visit an authorized Kia dealer/service partner.

⚠ CAUTION

If the seat belt pretensioner is not working properly, the SRS air bag warning light will illuminate even if there is no malfunction of the SRS air bag. If the SRS air bag warning light does not illuminate when the vehicle is in ON position, or if it remains illuminated after illuminating for approximately 3~6 seconds, or if it illuminates while the vehicle is being driven, have the system inspected by a professional workshop. Kia recommends visiting an authorized Kia dealer/service partner.

*** NOTICE**

- The pre-tensioner will activate not only in a frontal collision but also in a side collision, if the vehicle is equipped with a side or curtain air bag.

- When the Seat belt pretensioners are activated, a loud noise may be heard and fine dust, which may appear to be smoke, may be visible in the passenger compartment. These are normal operating conditions and are not hazardous.
- Although it is harmless, the fine dust may cause skin irritation and should not be breathed for prolonged periods. Wash all exposed skin areas thoroughly after an accident in which the seat belt pretensioners were activated.
- Because the sensor that activates the SRS air bag is connected with the seat belt pretensioner, the SRS air bag warning light on the instrument cluster will illuminate for approximately 3~6 seconds after the EV button has been turned to the "ON" position, and then it should turn off.

Seat belt precautions

WARNING

All occupants of the vehicle must wear their seat belts at all times. Seat belts and child restraints reduce the risk of serious or fatal injuries for all occupants in the event of a collision or sudden stop. Without a seat belt, occupants could be shifted too close to a deploying air bag, strike the interior structure or be thrown from the vehicle. Properly worn seat belts greatly reduce these hazards. Always follow the precautions about seat belts, air bags and occupant seat contained in this manual.

Infant or small child

You should be aware of the specific requirements in your country. Child and/or infant seats must be properly placed and installed in the rear seat.

Refer to "Child restraint system (CRS)" on page 4-21.

WARNING

Every person in your vehicle needs to be properly restrained at all times, including infants and children. Never hold a child in your arms or lap when riding in a vehicle. The violent forces created during a crash will tear the child from your arms and throw the child against the interior. Always use a child restraint appropriate for your child's height and weight.

NOTICE

Small children are best protected from injury in an accident when properly restrained in the rear seat by a child restraint system that meets the requirements of the Safety Standards of your country. Before buying any child restraint system, make sure that it has label certifying that it meets Safety Standards of your country. The restraint must be appropriate for your child's height and weight. Check the label on the child restraint for this information. Refer to "Child restraint system (CRS)" on page 4-21.

Larger children

Children who are too large for child restraint systems should always occupy the rear seat and use the available lap/shoulder belts. The lap portion should be fastened in such a way that it is snug on the hips and as low as possible. Periodically check whether the belt is properly fastened. A child's squirming could put the belt out of position. In the event of an accident, children are afforded the most safety when they are restrained by a proper restraint system in the rear seat. If a larger child (over age 13) must be seated in the front seat, the child should be securely restrained by the available lap/shoulder belt and the seat should be placed in the rearmost position. Children aged 13 and under should be restrained securely in the rear seat. NEVER place a child aged 13 or under in the front seat. NEVER place a rear facing child seat in the front seat of a vehicle. If the shoulder belt portion slightly touches the child's neck or face, try placing the child closer to the center of the vehicle. If the shoulder belt still touches their face or neck they need to be returned to a child restraint system.

WARNING

- Never allow a shoulder belt to be in contact with a child's neck or face while the vehicle is in motion.
- If seat belts are not properly worn and adjusted on children, there is a risk of death or serious injury.

Pregnant women

The use of a seat belt is recommended for pregnant women to lessen the chance of injury in an accident. When a seat belt is used, the lap belt portion should be placed as low and as snugly as possible on the hips, not across the abdomen. For specific recommendations, consult a physician.

WARNING

Pregnant women must never place the lap portion of the safety belt over the area of the abdomen where the fetus is located or above the abdomen where the belt could crush the fetus during an impact.

Injured person

A seat belt should be used when an injured person is being transported. When this is necessary, you should consult a physician for recommendations.

One person per belt

Two people (including children) should never attempt to use a single seat belt. This could worsen the injuries in the event of an accident.

Do not lie down

To reduce the chance of injuries in the event of an accident and to achieve maximum effectiveness of the restraint system, all passengers should be sitting up and the front seats should be in an upright position when the car is moving. A seat belt cannot provide proper protection if the person is lying down in the rear seat or if the front seat is in a reclined position.

⚠ WARNING

Riding with a reclined seatback increases your chance of serious or fatal injuries in the event of a collision or sudden stop. The protection of your restraint system (seat belts and air bags) is greatly reduced by reclining your seat. Seat belts must be snug against your hips and chest to work properly. The more the seatback is reclined, the greater the chance that an occupant's hips will slide under the lap belt causing serious internal injuries or the occupant's neck could strike the shoulder belt. Drivers and passengers should always sit well back in their seats, properly belted, and with the seatbacks upright.

Care of seat belts

Seat belt systems should never be disassembled or modified. In addition, care should be taken to ensure that seat belts and belt hardware are not damaged by seat hinges, doors, or other abuse.

⚠ WARNING

- When you return the rear seatback to its upright position after the rear seatback was folded down, be careful not to damage the seat belt webbing or buckle. Be sure that the webbing or buckle does not get caught or pinched in the rear seat. A seat belt with damaged webbing or buckle will not be as strong and could possibly fail during a collision or sudden stop, resulting in serious injury. If the webbing or buckles are damaged, get them replaced immediately.

- Seat belts can become hot in a vehicle that has been closed up in sunny weather. They could burn infants and children.

Periodic inspection

It is recommended that all seat belts be inspected periodically for wear or damage of any kind. Any damaged parts should be replaced as soon as possible.

Keep belts clean and dry

If belts become dirty, they can be cleaned by using a mild soap solution and warm water. Bleach, dye, strong detergents, or abrasives should not be used since they may damage and weaken the fabric.

When to replace seat belts

The entire in-use seat belt assembly or assemblies should be replaced if the vehicle has been involved in an accident. This should be done even if no damage is visible. In such case, have the system replaced by a professional workshop. Kia recommends to consult an authorized Kia dealer/service partner.

Child restraint system (CRS)

Our recommendation: Children always in the rear

Infants and younger children must be restrained in an appropriate rearward-facing or forward-facing CRS that has first been properly secured to the seat of the vehicle. Read and comply with the instructions for installation and use provided by the manufacturer of the Child Restraint System.

Children under the age of 13 should always ride in the rear seats; they must always be restrained properly to minimize the risk of injury in case of accident, sudden stop, or sudden maneuver. According to accident statistics, children are safer when properly restrained in the rear seats than when they are in the front seat. Children too large for a Child Restraint System must use the seat belts provided.

Most countries have regulations requiring that children travel in approved child restraint systems.

Laws governing the age or height/weight restrictions at which seat belts can be used instead of Child Restraint System differ among countries, so you should be aware of the specific requirements in your country/the country where you are driving.

Child Restraint Systems must be properly installed in the vehicle seat. Always use a commercially available Child Restraint System that meets the requirements of your country.

⚠ WARNING

- Always properly restrain children in the vehicle. Children of all ages are safer when riding in the rear seats. Never place a rearward-facing Child Restraint System on the front passenger seat, unless the air bag is deactivated.
- Always follow the Child Restraint System manufacturer's instructions for installation and use.
- Always properly restrain your child in the Child Restraint System.
- Do not use an infant carrier or a child safety seat that "hooks" over a seat-back, it may not provide adequate protection in an accident.
- After an accident, have the system checked by a professional workshop. Kia recommends visiting an authorized Kia dealer/service partner.

Selecting a Child Restraint System (CRS)

Operation

- Select a Child Restraint System based on your child's height and weight. The required label or the instructions for use typically provide this information.
- Select a Child Restraint System that fits the vehicle seating position where it will be used.

*** INFORMATION**

- Make sure the Child Restraint System has a label certifying that it meets the applicable Safety Standards of your country. A Child Restraint System may only be installed if it was approved in accordance with the requirements of ECE-R44 or ECE-R129 or relevant.

- Select a Child Restraint System based on your child's height and weight. The required label or the instructions for use typically provide this information.
- Select a Child Restraint System that fits the vehicle seating position where it will be used. For the suitability of Child Restraint Systems on the vehicle's seating positions, please refer to "Suitability of each seating position for belted & ISOFIX Child Restraint Systems (CRS) according to UN regulations (Information for use by vehicle users and CRS manufacturers)" on page 4-26.
- Read and comply with the warnings and instructions for installation and use provided with the Child Restraint System.

restraint system: infant-only child restraint systems can only be used facing rearward. Convertible and 3-in-1 Child Restraint Systems typically have higher height and weight limits for the rearward-facing position, allowing you to keep your child rearward-facing for a longer period of time.

Keep using child restraint systems in the rearward-facing position as long as the children are within the height and weight limits specified by the child restraint system's manufacturer.

A forward-facing Child Restraint System provides restraint for the child's body with a harness. Keep children in a forward-facing child restraint system with a harness until they reach the maximum height or weight limit allowed by your child restraint system's manufacturer.

Once your child outgrows the forward-facing Child Restraint System, your child is ready for a booster seat.

Child restraint system types

Forward/rearward-facing Child Restraint System

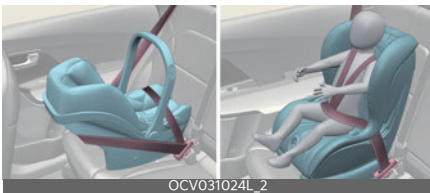

A rearward-facing Child Restraint System provides restraint with the seating surface against the back of the child. The harness system holds the child in place and, in an accident, keeps the child positioned in the child restraint system and reduces stress to the fragile neck and spinal cord.

All children under the age of one year must always ride in a rearward-facing Child Restraint System. There are different types of rearward-facing child

Booster seats

A booster seat is a Child Restraint System designed to improve the fit of the vehicle's seat belt system. A booster seat positions the seat belt so that it fits properly over the stronger parts of your child's body. Keep your children in booster seats until they are big enough to fit in a seat belt properly.

For a seat belt to fit properly, the lap belt must lie comfortably across the upper thighs, not the stomach. The shoulder belt should lie comfortably across the shoulder and chest and not across the neck or face. Children under the age of 13 should always ride in the rear seats; they must always be restrained properly to minimize the risk of injury in case of

accident, sudden stop, or sudden maneuver.

Installing a Child Restraint System (CRS)

Operation

1. Properly secure the Child Restraint System to the vehicle.
2. Make sure the Child Restraint System is firmly secured.
3. Secure the child in the Child Restraint System.

⚠ WARNING

- Before installing your Child Restraint System always: Read and follow the instructions provided by the manufacturer of the Child Restraint System. Failure to follow all warnings and instructions could increase the risk of the serious injury or death if an accident occurs.
- If the vehicle's headrest prevents proper installation of a Child Restraint System, the headrest of the respective seating position shall be readjusted or entirely removed.

⚠ CAUTION

A Child Restraint System in a closed vehicle can become very hot. To prevent burns, check the seating surface and buckles before placing your child in the Child Restraint System.

ISOFIX anchorage and top-tether anchorage (ISOFIX Anchorage System) for children

ISOFIX anchorages are metal bars built into the vehicle. There are two lower anchors for each ISOFIX seating position that will accommodate a Child Restraint System with lower attachments.



OCV031099L_3

- 1 ISOFIX anchor position indicator
- 2 ISOFIX anchor

ISOFIX anchorages have been provided in the left and right outboard rear seating positions.



OCV031026L

⚠ WARNING

Do not attempt to install a Child Restraint System using ISOFIX anchorages in the rear center seating position. There are no ISOFIX anchorages provided for this seat. Using the outboard seat anchorages, for the CRS installation on the rear center seating position, can damage the anchorages.

- NEVER attach more than one Child Restraint System to a single anchorage. This could cause the anchor or attachment to come loose or break.
- Always have the ISOFIX (i- Size) system inspected by your dealer after an accident. An accident can damage the ISOFIX system and may not properly secure the Child Restraint System.

Securing a Child Restraint System with the "ISOFIX Anchorage" system

Securing a Child Restraint System with the "Top-tether Anchorage" system

Operation

⚠ WARNING

Take the following precautions when using the ISOFIX system:

- Read and follow all installation instructions provided with your Child Restraint System.
- To prevent the child from reaching and taking hold of unretracted seat belts, buckle all unused rear seat belts and retract the seat belt webbing behind the child. Children can be strangled if a shoulder belt becomes wrapped around their neck and the seat belt tightens.

Type A



Type B



Operation

⚠ WARNING

Take the following precautions when installing the top-tether:

- Read and follow all installation instructions provided with your Child Restraint System.
- NEVER attach more than one Child Restraint System to a single ISOFIX top-tether anchorage. This could cause the anchorage or attachment to come loose or break.
- Do not attach the top-tether to anything other than the correct top-tether anchorage. It may not work properly if attached to something else.
- Child restraint anchorages are designed to withstand only those loads imposed by correctly fitted child restraints. Under no circumstances are they to be used for adult seat belts, harnesses, or for attaching other items or equipment to the vehicle.

Securing a Child Restraint System with a lap/shoulder belt

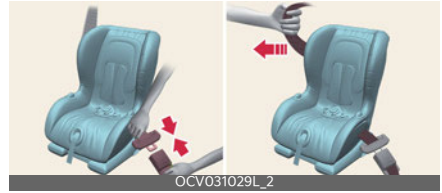

Operation

1. Place the Child Restraint System on a rear seat and route the lap/shoulder belt around or through the Child Restraint System.
2. Fasten the lap/shoulder belt latch into the buckle.
3. Remove as much slack from the belt as possible by pushing down on the Child Restraint System while feeding the shoulder belt back into the retractor.
4. Push and pull on the Child Restraint System to confirm that the seat belt is holding it firmly in place.
5. If your Child Restraint System manufacturer recommends the use of a top-tether with the lap/shoulder belt, see Securing a child restraint system seat with the "top-tether anchorage" system section in this chapter.
6. To remove the Child Restraint System, press the release button on the buckle, and then pull the lap/shoulder belt out of the Child Restraint System and allow the seat belt to retract fully.

Suitability of each seating position for belted & ISOFIX Child Restraint Systems (CRS) according to UN regulations (Information for use by vehicle users and CRS manufacturers)

- Yes : Suitable for fitment of the designated category of CRS
- No : Not suitable for fitment of the designated category of CRS
- "-": Not applicable
- The table is based on LHD vehicle. Except for the front passenger seat, the table is valid for RHD vehicle. For RHD vehicle front passenger seat, please use information for the seating position number 3.

F: Forward facing

R: Rearward facing

CRS categories		Seating positions						
		1	2	3		4	5	6
				Airbag ON	Airbag OFF			
Universal belted CRS	All mass groups	-	-	No	Yes ¹ (F, R)	Yes (F, R)	Yes ² (F, R)	Yes (F, R)
i-size CRS	ISOFIX CRF: F2, F2X, R1, R2	-	-	No	No	Yes	No	Yes
Carry-cot (ISOFIX lateral facing CRS)	ISOFIX CRF: L1, L2	-	-	No	No	No	No	No
ISOFIX infant* CRS (*: ISOFIX baby CRS)	ISOFIX CRF: R1	-	-	No	No	Yes (R)	No	Yes (R)
ISOFIX toddler CRS - small	ISOFIX CRF: F2, F2X, R2, R2X	-	-	No	No	Yes (F, R)	No	Yes (F, R)
ISOFIX toddler CRS - large* (*: not booster seats)	ISOFIX CRF: F3, R3	-	-	No	No	Yes (F, R ³)	No	Yes (F, R ³)
Booster Seat - reduced Width	ISO CRF: B2	-	-	No	No	Yes ⁴	No	Yes ⁴
Booster Seat - full Width	ISO CRF: B3	-	-	No	No	Yes ⁴	No	Yes ⁴

* 1. You should adjust the front passenger seat height to the highest position. (Seat number 3)

* 2. The seating position (number 5) is not suitable for fitment of child restraint system with support leg.

* 3. For fitment of ISOFIX toddler's rearward large CRS

- Driver Seat: You should move the seat at mid position. (Seat number 1)

- Front Passenger Seat: You should move the seat at mid position. (Seat number 3)

* 4. If the vehicle headrest prevents proper installation of a CRS, the headrest of the seating position shall be readjusted or entirely removed.

Seat Number Position in the vehicle	
1	Front left
2	Front center
3	Front right
4	2nd row left
5	2nd row center
6	2nd row right



* Never place a rearward facing Child Restraint System on the front passenger seat, unless the air bag is deactivated.

* For semi-universal or vehicle specific CRS (ISOFIX or belted CRS), please see the vehicle list provided in the manual of CRS

Recommended CRS for Vehicle according to UN regulations

Child Height / Mass Group	Name	Manufacturer	Type of Fixation	ECE-R44 Approval No.
40-83 cm	BABY-SAFE 3 i-SIZE CRS with FLEX BASE i-SENSE	Britax Römer	ISOFIX with Support leg (Rearward facing)	E1*129R03/04*0060
76-105 cm	TRIFIX ² i-SIZE	Britax Römer	ISOFIX and TOP TETHER	E1*129R02/06*001
Group II	KidFix2 R	Britax Römer	ISOFIX and vehicle belt, using CRS lap belt guide	ECE-R44-E1-04301304
Group III	Viaggio 2-3 shuttle	Peg Perego	ISOFIX and Vehicle belt	ECE R44/04-E24-0000256

CRS Manufacturer information

Britax Römer: www.britax.com

Peg Perego: www.pegperego.com

Air bag - supplemental restraint system

Left-hand drive

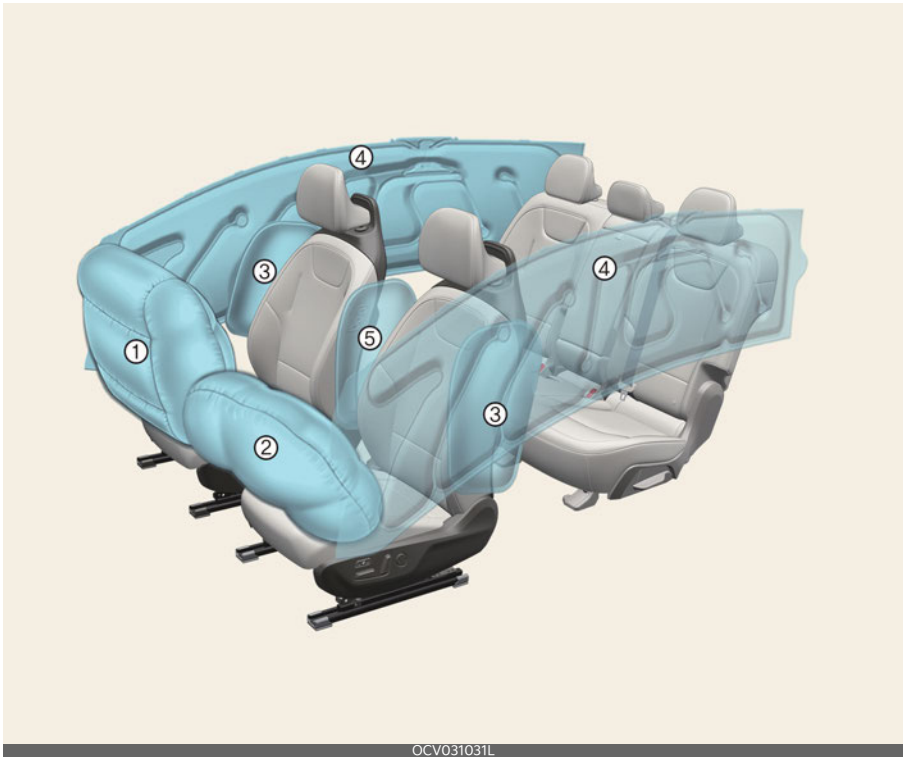

* The actual features in your vehicle may not necessarily be available due to the selected options or regions.

- 1 Passenger's front air bag
- 2 Driver's front air bag
- 3 Side air bag
- 4 Curtain air bag
- 5 Front center side air bag

Right-hand drive

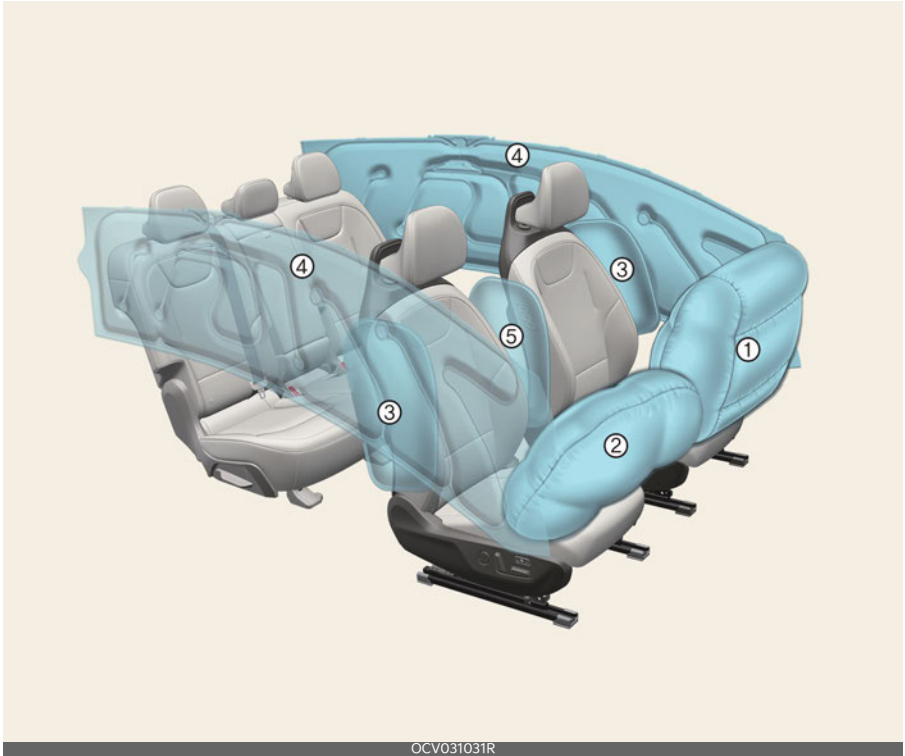

OCV031031R

* The actual features in your vehicle may not necessarily be available due to the selected options or regions.

- 1 Passenger's front air bag
- 2 Driver's front air bag
- 3 Side air bag
- 4 Curtain air bag
- 5 Front center side air bag

How does the air bag system operate?

- Air bags are activated (able to inflate if necessary) only when the EV button is in the ON position and it can be activated within about 3 minutes after the vehicle is in OFF position.
- Air bags inflate instantly in the event of serious frontal or side collision (if a side air bag or a curtain air bag is present) in order to help protect the occupants from serious physical injury.
- Generally, air bags are designed to inflate based upon the severity of a collision and its direction, etc. These two factors determine whether the sensors produce electronic deployment/inflation signal.
- Air bags will inflate based upon the severity of a collision and its direction, etc. Air bags will not inflate in every crash or collision situation.
- The front air bags will completely inflate and deflate in an instant. It is virtually impossible for you to see the air bags inflate during an accident. It is much more likely that you will simply see the deflated air bags hanging out of their storage compartments after the collision.
- In order to help provide protection in a severe collision, the air bags must inflate rapidly. The speed of air bag inflation is due to the extremely short time when a collision occurs and the need to get the air bag between the occupant and the vehicle structures before the occupant impacts those structures. This speed of inflation reduces the risk of serious or life-threatening injuries in a severe collision

and is thus a necessary part of air bag design.

- However, air bag inflation can also cause injuries, including facial abrasions, bruises, and broken bones, because the inflation speed also causes the air bags to expand with a great deal of force.
- There are even circumstances under which contact with the steering wheel air bag can cause fatal injuries, especially if the occupant is positioned excessively close to the steering wheel.

WARNING

- Even in vehicles with air bags, you and your passengers must always wear the safety belts provided in order to minimize the risk and severity of injury in the event of a collision or in most rollover situations.
- SRS and pre-tensioners contain explosive chemicals. If scraping a vehicle without removing SRS and pre-tensioners from a vehicle, it may cause fire. Before scraping a vehicle, contact a professional workshop. Kia recommends visiting an authorized Kia dealer/service partner.
- Keep the SRS parts and wirings away from water or any liquid. If the SRS components are inoperative due to exposure to water or liquids, it may cause fire or severe injury.
- To avoid severe personal injury or death caused by deploying air bags in a collision, the driver should sit as far back from the steering wheel air bag. The front passenger should always move their seat as far back as possible and sit back in their seat.

- Air bag inflates instantly in an event of a collision, passengers may be injured by the air bag expansion force if they are not in a proper position.
- Air bag inflation may cause injuries including facial or bodily abrasions, injuries from broken glasses or burns.

* NOTICE

If equipped with rollover sensor

Also, the air bags inflate instantly in the event of a rollover (if equipped with a side air bag or curtain air bag) in order to help protect the occupants from serious physical injury.

Noise and smoke

When the air bags inflate, they make a loud noise and leave smoke and powder in the air inside of the vehicle. This is normal and is a result of the ignition of the air bag inflator. After the air bag has inflated, you may feel substantial discomfort in breathing due to the contact between your chest and both the seat belt and the air bag, as well as from breathing the smoke and powder.

Open your doors and/or windows as soon as possible after an impact in order to reduce discomfort and prevent prolonged exposure to the smoke and powder.

Though the smoke and powder are non-toxic, they may cause skin irritation (eyes, nose, throat, etc.). If this is the case, wash and rinse with cold water immediately and consult the doctor if the symptom persists.

⚠ WARNING

- When the air bags deploy, the air bag related parts in the steering wheel and/or instrument cluster and/or in both sides of the roof rails above the front and rear doors are very hot. To prevent injury, do not touch the air bag storage areas internal components immediately after an air bag has inflated.
- Do not install or place any accessories near air bag deployment areas, such as the instrument cluster, windows, pillars, and roof rails.

Air bag warning and indicator light

Air bag warning light

Operating condition(s)

- When the vehicle is running
 - The air bag warning light should illuminate for approximately 3~6 seconds and go off.

Malfunction

- The air bag warning light does not turn on briefly when the vehicle is running.
- The air bag warning light stays on after illuminating for approximately 3~6 seconds.
- The air bag warning light comes on while the vehicle is moving.

Passenger's front air bag ON/OFF switch (if equipped)

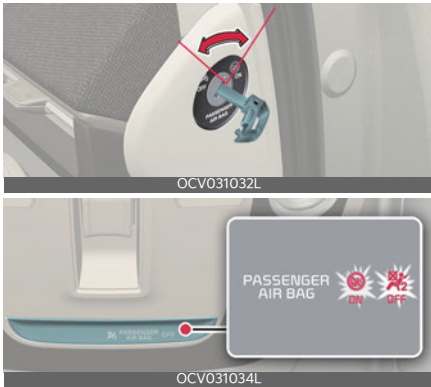

- When the passenger's front air bag ON/OFF switch is set to the ON/OFF position
 - The Front passenger air bag ON/OFF indicator is illuminated.

Non-operating condition(s)

- When the vehicle is running within approximately 3 minutes after the vehicle is turned off
 - The front air bag ON/OFF indicator will not illuminate.

⚠ WARNING

Operation

1. Insert master key into the passenger's front air bag ON/OFF switch.
2. Turn the key to activate/deactivate passenger's front air bag.
 - When the child restraint is installed on the front passenger's seat.
 - When the seat is unoccupied.

Front passenger air bag ON/OFF indicator



- The front air bag ON/OFF switch could turn by using a similar small rigid device. Always check the status of the front air bag ON/OFF switch and Front passenger air bag ON/OFF indicator.
- The driver is responsible for the proper position of the passenger's front air bag ON/OFF switch.
- Deactivate the passenger's front air bag only when the EV button is in OFF position, or the malfunction may occur in the SRS Control Module.

And there may be a danger that the driver's and/or front passenger's and/or side and curtain air bag may fail to trigger, or not trigger correctly during a collision.

- Never install a rearward facing child seat on the front passenger's seat unless the passenger's front air bag has been deactivated. The infant or child could be severely injured or killed by an air bag deployment in case of an accident.
- Even though your vehicle is equipped with the passenger's front air bag ON/OFF switch, do not install a child restraint system in the front passen-

Operating condition(s)

- After the vehicle is running
 - The Front passenger air bag ON/OFF indicator illuminates for approximately 4 seconds.

ger's seat. A child restraint system must never be placed in the front seat. Children who are too large for child restraint systems should always occupy the rear seat and use the available lap/shoulder belts. In the event of an accident, children are afforded the most safety when they are restrained by a proper restraint system in the rear seat.

- As soon as the child seat is no longer needed on the front passenger's seat, reactivate the front passenger's air bag.
- Never place or insert any object into any small opening near side airbag labels attached to the vehicle seats. When the air bag deploys, the object may affect the deployment and result in unexpected accident or bodily harm.
- No objects (such as crash pad cover, cellular phone holder, cup holder, perfume or stickers) should be placed over or near the air bag modules on the steering wheel, instrument cluster, windshield glass, and the front passenger's panel above the glove box. Such objects could cause harm if the vehicle is in a crash severe enough to cause the air bags to deploy. Do not place any objects over the air bag or between the air bag and yourself.

CAUTION

- If the passenger's front air bag ON/OFF switch is not working properly, the air bag warning light on the instrument panel will illuminate. And, the passenger's front air bag OFF indicator (🚫) will not illuminate (The passenger's front air bag ON indicator comes on), the SRS Control Module reactivate the passenger's front air bag and the passenger's front air bag will inflate in frontal impact crashes even if the passenger's front air bag ON/OFF switch is set to the OFF position (🚫). In this case, have the system inspected by a professional workshop. Kia recommends visiting an authorized Kia dealer/service partner.
- If the SRS air bag warning light blinks or does not illuminate when the EV button is in ON position, or if it illuminates while the vehicle is being driven, have the system inspected by a professional workshop. Kia recommends visiting an authorized Kia dealer/service partner.

NOTICE

- When the passenger's front air bag ON/OFF switch is set to the ON position, the passenger's front air bag is activated and child or infant seat should not be installed on the front passenger's seat.
- When the passenger's front air bag ON/OFF switch is set to the OFF position, the passenger's front air bag is deactivated.

SRS components and functions

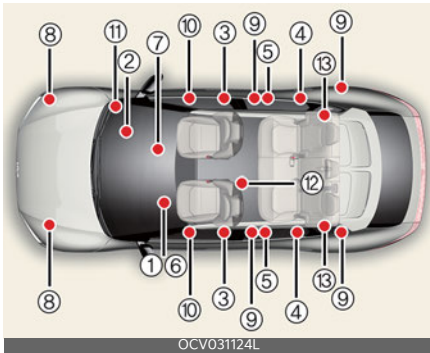

* The actual features in your vehicle may not necessarily be available due to the selected options or regions.

- 1 Driver's front air bag module
- 2 Passenger's front air bag module
- 3 Side air bag modules
- 4 Curtain air bag modules
- 5 Retractor pre-tensioner assemblies
- 6 Air bag warning light
- 7 SRS control module (SRSCM)/rollover sensor
- 8 Front impact sensors
- 9 Side impact sensors
- 10 Side pressure sensors
- 11 Passenger's front air bag ON/OFF switch
- 12 Driver's center air bag module
- 13 Rear retractor pre-tensioner assemblies (if equipped)

Operating condition(s)

- EV button is in ON position
 - The SRS air bag warning light will illuminate for approximately 6 seconds and go out.

⚠ WARNING

If any of the following conditions occurs, this indicates a malfunction of the SRS. In this case, have the system inspected by a professional workshop. Kia recommends visiting an authorized Kia dealer/service partner.

- The light does not turn on briefly when you turn the vehicle ON.
- The light stays on after illuminating for approximately 6 seconds.
- The light comes on while the vehicle is in motion.
- The light blinks when the vehicle is in ON position.

Driver's front air bag (1)



Driver's front air bag (2)



Driver's front air bag (3)



Passenger's front air bag



The air bag modules are located both in the center of the steering wheel and in the front passenger's panel above the glove box. When the SRSCM detects a sufficiently severe impact to the front of the vehicle, it will automatically deploy the front air bags.

Upon deployment, tear seams molded directly into the pad covers will separate under pressure from the expansion of the air bags. Further opening of the covers then allows full inflation of the air bags.

A fully inflated air bag, in combination with a properly worn seat belt, slows the driver's or the passenger's forward motion, reducing the risk of head and chest injury.

After complete inflation, the air bag immediately starts deflating, enabling the driver to maintain forward visibility and the ability to steer or operate other controls.

⚠ WARNING

- Do not install or place any accessories (drink holder, CD holder, sticker, etc.) on the front passenger's panel above the glove box in a vehicle with a passenger's air bag. Such objects may become dangerous projectiles and cause injury if the passenger's air bag inflates.
- When installing a container of liquid air freshener inside the vehicle, do not place it near the instrument cluster nor on the instrument panel surface. It may become dangerous projectiles and cause injury if the passenger's air bag inflates.
- If an air bag deploys, there may be a loud noise followed by a fine dust released in the vehicle. These conditions are normal and are not hazardous - the air bags are packed in this fine powder. The dust generated during air bag deployment may cause skin or eye irritation as well as aggravate asthma for some persons. Always wash all exposed skin areas thoroughly with cold water and a mild soap after an accident in which the air bags were deployed.
- The SRS can function only when the EV button is in the ON position and within approximately 3 minutes after the vehicle is in OFF position. If the SRS air bag warning light does not illuminate, or continuously remains on after illuminating for about 6 seconds when the EV button is in ON position, or after the vehicle is started, comes on while driving, the SRS is not working properly. In this case, have the system inspected by a professional workshop. Kia recommends visiting an authorized Kia dealer/service partner.
- Before you replace a fuse or disconnect a battery terminal, press EV button to OFF position. Never remove or replace the air bag related fuse(s) when the EV button is in the ON position. Failure to heed this warning will cause the SRS air bag warning light to illuminate.

Driver's and passenger's front air bags



The indications of the system's presence are the words **AIR BAG** intagliated on the air bag pad cover in the steering wheel, and the passenger's side front panel pad above the glove box.

WARNING

- The driver's hands should be placed on the steering wheel at the 9:00 and 3:00 positions. The passenger's arms and hands should be placed on their laps.
 - Always use seat belts and child restraints - every trip, every time, everyone! Air bags inflate with considerable force and in the blink of an eye. Seat belts help keep occupants in proper position to obtain maximum benefit from the air bag. Even with air bags, improperly and unbelted occupants can be severely injured when the air bag inflates. Always follow the precautions about seat belts, air bags and occupant safety contained in this manual.
 - To reduce the chance of serious or fatal injuries and receive the maximum safety benefit from your restraint system:
 - Never place a child in any child or booster seat in the front seat.
 - ABC - Always Buckle Children in the back seat. It is the safest place for children of any age to ride.
- Front and side air bags can injure occupants improperly positioned in the front seats.
 - Move your seat as far back as practical from the front air bags, while still maintaining control of the vehicle.
 - You and your passengers should never sit or lean unnecessarily close to the air bags. Improperly positioned drivers and passengers can be severely injured by inflating air bags.
 - Never lean against the door or center console - always sit in an upright position.
 - No objects should be placed over or near the air bag modules on the steering wheel, instrument panel, and the front passenger's panel above the glove box, because any such object could cause harm if the vehicle is in a crash severe enough to cause the air bags to deploy.
 - If the SRS air bag warning light remains illuminated while the vehicle is being driven, have the system inspected by a professional workshop. Kia recommends visiting an authorized Kia dealer/service partner.
 - Air bags can only be used once - have the system replaced by a professional workshop. Kia recommends visiting an authorized Kia dealer/service partner.
 - The SRS is designed to deploy the front air bags only when an impact is sufficiently severe. Additionally, the air bags will only deploy once. Seat belts must be worn at all times.
 - Front air bags are not intended to deploy in side-impact, rear-impact

or rollover crashes. In addition, front air bags will not deploy in frontal crashes below the deployment threshold.

- A child restraint system must never be placed in the front seat. The infant or child could be severely injured or killed by an air bag deployment in case of an accident.
- Children age 13 and under must always be properly restrained in the rear seat. Never allow children to ride in the front passenger seat. If a child over age 13 must be seated in the front seat, he or she must be properly belted and the seat should be moved as far back as possible.
- For maximum safety protection in all types of crashes, all occupants including the driver should always wear their seat belts whether or not an air bag is also provided at their seating position to minimize the risk of severe injury or death in the event of a crash. Do not sit or lean unnecessarily close to the air bag while the vehicle is in motion.
- Sitting improperly or out of position can result in serious or fatal injury in a crash. All occupants should sit upright with the seat back in an upright position, center on the seat cushion with their seat belt on, legs comfortably extended and their feet on the floor until the vehicle is parked.
- The SRS air bag system must deploy very rapidly to provide protection in a crash. If an occupant is out of position because of not wearing a seat belt, the air bag may forcefully contact the occupant causing serious or fatal injuries.

Side air bag and front center air bag

Your vehicle is equipped with a side air bag in each front and front center air bag in each front seat.



* The actual air bags in the vehicle may differ from the illustration.

The purpose of the air bag is to provide the vehicle's driver and/or front passenger with protection in addition to that offered by the seat belt alone.

The side air bags and front center air bag are designed to deploy only during certain side-impact collisions, depending on the crash severity. The side air bags and driver's center air bag are not designed to deploy in all side impact situations.

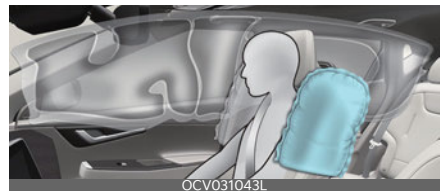

* The actual air bags in the vehicle may differ from the illustration.

⚠ WARNING

- Do not allow the passengers to lean their heads or bodies onto doors, put their arms on the doors, stretch their arms out of the window, or place objects between the doors and passengers when they are seated on seats equipped with side and/or curtain air bags.
- The side air bag and front center air bag are supplemental to the driver's and the passenger's seat belt systems and is not a substitute for them. Therefore your seat belts must be worn at all times while the vehicle is in motion. The air bags deploy only in certain side impact or rollover conditions (Only vehicle equipped with rollover sensor) severe enough to cause significant injury to the vehicle occupants.
- For best protection from the side air bag system and to avoid being injured by the deploying side air bag, both front seat occupants should sit in an upright position with the seat belt properly fastened.
- Do not use any accessory seat covers.
- Use of seat covers could reduce or prevent the effectiveness of the system.
- To prevent unexpected deployment of the side air bag and driver's center air bag that may result in personal injury, avoid impact to the side impact sensor when the EV button is in ON position and within approximately 3 minutes after the vehicle is in OFF position.
- If the seat or seat cover is damaged, have the system serviced by a professional workshop.

- Kia recommends visiting an authorized Kia dealer/service partner.
- Do not place any objects over the air bag or between the air bag and yourself. Also, do not attach any objects around the area the air bag inflates such as the door, side door glass, front and rear pillar.
- Do not place any objects between the door and the seat. They may become dangerous projectiles if the side air bag inflates.
- Do not install any accessories on the side or near the side air bags.

*** NOTICE**

- **If equipped with rollover sensor**
Also, the air bags inflate instantly in the event of a rollover (if equipped with a side air bag or curtain air bag) in order to help protect the occupants from serious physical injury.

Curtain air bag

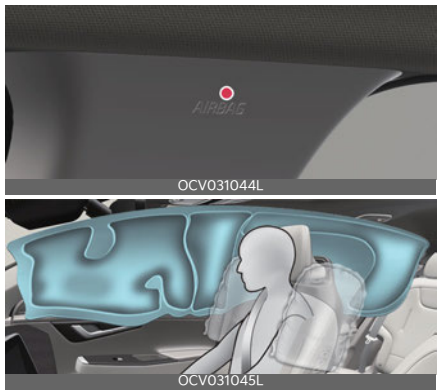

* The actual air bags in the vehicle may differ from the illustration.

Curtain air bags are located along both sides of the roof rails above the front and rear doors.

They are designed to help protect the heads of the front seat occupants and the rear outboard seat occupants during certain side impact collisions.

The curtain air bags are designed to deploy during certain side impact collisions, depending on the crash severity. The curtain air bags are not designed to deploy in all side impact situations, or during collisions from the front or rear of the vehicle or in most rollover situations.

WARNING

- Failure to follow the instructions mentioned can result in injury or death to the vehicle occupants in an accident.
 - Do not hang heavy items on the coat hooks for safety reasons.
 - In order for side and curtain air bags to provide the best protection, both front seat occupants and both outboard rear occupants should sit in an upright position with the seat belts properly fastened.
Importantly, children should sit in a proper child restraint system in the rear seat.
 - When children are seated in the rear outboard seats, they must be seated in the proper child restraint system.
Make sure to put the child restraint system as far away from the door side as possible, and secure the child restraint system in a locked position.
 - Do not allow the passengers to lean their heads or bodies onto doors, put their arms on the doors, stretch their arms out of the window, or place objects between the doors and passengers when they are

seated on seats equipped with side and/or curtain air bags.

- Never try to open or repair any components of the curtain air bag system. If necessary, have the system serviced by a professional workshop. Kia recommends visiting an authorized Kia dealer/service partner.
- Do not place any objects over the air bag. Also, do not attach any objects around the area the air bag inflates such as the door, side door glass, front and rear pillar, roof side rail.
- Do not hang hard or breakable objects on the clothes hanger.

NOTICE

If equipped with rollover sensor

Also, the air bags inflate instantly in the event of a rollover (if equipped with a side air bag or curtain air bag) in order to help protect the occupants from serious physical injury.

Air bag collision sensors



OCV031046L



* The actual features in your vehicle may not necessarily be available due to the selected options or regions.

- 1 Supplemental Restraint System (SRS) control module/rollover sensor
- 2 Front impact sensor
- 3 Side pressure sensors (front door)
- 4 Side impact sensor (B-pillar)
- 5 Side impact sensor (C-pillar)

⚠ WARNING

- Do not hit or allow any objects to impact the locations where air bag or sensors are installed.

This may cause unexpected air bag deployment, which could result in serious personal injury or death.

- If the installation location or angle of the sensors is altered in any way, the air bags may deploy when they should not or they may not deploy when they should, causing severe injury or death.

Therefore, do not try to perform maintenance on or around the air bag sensors. Have the system serviced by a professional workshop. Kia recommends visiting an authorized Kia dealer/service partner.

- Problems may arise if the sensor installation angles are changed due to the deformation of the front bumper, body or B pillar where side collision sensors are installed. In this case, have the system serviced by a professional workshop. Kia recommends to visit an authorized Kia dealer/service partner.

- Your vehicle has been designed to absorb impact and deploy the air bag(s) in certain collisions. Installing bumper guards or replacing a bumper with non-genuine parts may adversely affect your vehicles collision and air bag deployment performance.

- **If equipped with rollover sensor**



If your vehicle is equipped with side and curtain air bag, press EV button to OFF position and wait for 3 minutes when the vehicle is being towed.

The side and curtain air bag may deploy when the EV button is in ON or

OFF position within 3 minutes, and the rollover sensor detects the situation as a rollover.

Air bag inflation conditions

* The actual air bags in the vehicle may differ from the illustration.

Air bag inflation conditions	
 <p>OCV031052L</p>	<p>Front air bags are designed to inflate in a frontal collision depending on the intensity, speed or angles of impact of the front collision.</p>
 <p>OCV031045L</p>  <p>OCV031056L</p>	<p>Side and/or curtain air bags are designed to inflate when an impact is detected by side collision sensors depending on the strength, speed or angles of impact resulting from a side impact collision.</p>

*** INFORMATION**

- **Side and curtain air bags**

The side and curtain air bags are designed to inflate when a rollover is detected by a rollover sensor.

Although the front air bags (driver's and front passenger's air bags) are designed to inflate only in frontal collisions, they also may inflate in other types of collisions if the front impact sensors detect a sufficient impact. Side air bags (side and/or curtain air bags) are designed to inflate only in side impact collisions, but they may inflate in other collisions if the side impact sensors detect a sufficient impact.

For instance, side airbag and curtain air bags may inflate if rollover sensors indicate the possibility of a rollover occurring (even if none actually

occurs) or in other situations, including when the vehicle is tilted while being towed. Even if side and/or curtain air bags do not provide impact protection in a rollover, they will deploy to prevent ejection of occupants, especially those who are restrained with seat belts.



If the vehicle chassis is impacted by bumps or objects on unimproved roads or sidewalks, air bags may deploy. Drive carefully on unimproved roads or on surfaces not designed for vehicle traffic to prevent unintended air bag deployment.





*** NOTICE**

If equipped with rollover sensor

Also, the side and curtain air bags are designed to inflate when a rollover is detected by a rollover sensor.

Air bag non-inflation conditions

Air bag non-inflation conditions	
 OCV031052L	In certain low-speed collisions the air bags may not deploy.
 OCV031053L	Air bags are not designed to inflate in rear collisions.
 OCV031054L	Heavy braking lowers the front portion of the vehicle causing it to "ride" under a vehicle with a higher ground clearance. Air bags may not inflate in this "under-ride" situation because deceleration forces that are detected by sensors may be significantly reduced by such "under-ride" collisions.

Air bag non-inflation conditions	
 OCV031055L	In an angled collision, the force of impact may send the occupants in a direction where the air bags would not be able to provide any additional benefit; thus, the sensors may not deploy any air bags.
 OCV031056L	Front air bags may not inflate in side impact collisions.
 OCV031057L	Air bags may not inflate in rollover accidents because the vehicle cannot detect the rollover.
 OCV031058L	Air bags may not inflate if the vehicle collides with objects such as utility poles or trees, meaning the point of impact is concentrated in one area and the full force of the impact is not delivered to the sensors.

⚠ WARNING

- The SRS is designed to deploy the front air bags only when an impact is sufficiently severe and when the impact angle is less than 30° from the forward longitudinal axis of the vehicle.
- Front air bags are not intended to deploy in side-impact, rear-impact or rollover crashes. In addition, front air bags will not deploy in frontal crashes below the deployment threshold.
- The air bags deploy only in certain side impact or rollover conditions (Only vehicle equipped with rollover sensor) severe enough to cause significant injury to the vehicle occupants.

- Deactivate the passenger's front air bag only when the vehicle is in OFF position, or the malfunction may occur in the SRS Control Module. And there may be a danger that the driver's and/or front passenger's and/or side and curtain air bag may fail to trigger, or not trigger correctly during a collision.
- If an air bag deploys, there may be a loud noise followed by a fine dust released in the vehicle. These conditions are not hazardous.
- The air bags are packed in this fine power. The dust generated during air bag deployment It may cause skin or eye irritation as well as aggravate asthma for some persons. Always wash all exposed skin areas thoroughly with cold water and a mild soap after an accident in which the air bags were deployed.
- For cleaning the air bag pad covers, use only a soft, dry cloth or one which has been moistened with plain water.
- Solvents or cleaners could adversely affect the air bag covers and proper deployment of the system.
- Keep the SRS parts and wirings away from water or any liquid. If the SRS components are inoperative due to exposure to water or liquids, it may cause fire or severe injury.
- If any of the following conditions occurs, this indicates a malfunction of the SRS. In this case, have the system inspected by a professional workshop. Kia recommends visiting an authorized Kia dealer/service partner.
 - The light does not turn on briefly when you turn the vehicle ON.
 - The light stays on after illuminating for approximately 6 seconds.
- The light comes on while the vehicle is in motion.
- The light blinks when the EV button is in ON position.
- Before you replace a fuse or disconnect a battery terminal, turn the EV button to OFF position. Never remove or replace the air bag related fuse(s) when the EV button is in the ON position. Failure to heed this warning will cause the SRS air bag warning light to illuminate.
- Do not tamper with or disconnect wiring or other components of the SRS system, including the addition of any kind of badges to the pad covers or modifications to the body structure. Doing so could adversely affect SRS performance and lead to possible injury. If necessary, have the system serviced by a professional workshop. Kia recommends visiting an authorized Kia dealer/service partner.
- If your vehicle was flooded and has soaked carpeting or water on flooring, you shouldn't try to start the vehicle; In this situation, have your vehicle inspected by a professional workshop. Kia recommends to contact an authorized Kia dealer/service partner.
- Air bags can only be used once. If the air bags inflate, have the system replaced by a professional workshop. Kia recommends visiting an authorized Kia dealer/service partner.
- If components of the air bag system must be discarded, or if the vehicle must be scrapped, certain safety precautions must be observed, such as removing SRS and pre-tensioners from a vehicle due to the risk of fire. Failure to follow these precautions and procedures could increase the

risk of personal injury. An authorized Kia dealer knows these precautions and can give you the necessary information.

*** NOTICE**

• **With rollover sensor**

The side and curtain air bags are designed to inflate when a rollover is detected by a rollover sensor. The air bags may inflate in a rollover, when it is detected by the rollover sensor.

• **Without rollover sensor**

The side and/or curtain air bags may inflate when the vehicle is rolled over by a side impact collision, if the vehicle is equipped with side air bags and curtain air bags.

SRS care

The SRS is virtually maintenance-free, and there are no parts you can safely service by yourself.

If the SRS air bag warning light does not illuminate, or continuously remains on, have the system inspected by a professional workshop. Kia recommends visiting an authorized Kia dealer/service partner.

⚠ WARNING

- Modification to SRS components or wiring, including the addition of any kind of badges to the pad covers or modifications to the body structure, can adversely affect SRS performance and lead to possible injury.
 - If components of the air bag system must be discarded, or if the vehicle must be scrapped, certain safety precautions must be observed. An authorized Kia dealer knows these precautions and can give you the necessary information. Failure to follow these precautions and procedures could increase the risk of personal injury.
-

Additional safety precautions

- **Never let passengers ride in the cargo area or on top of a folded-down back seat.** All occupants should sit upright, fully back in their seats with their seat belts on and their feet on the floor.
- **Passengers should not move out of or change their seat while the vehicle is moving.** A passenger who is not wearing a seat belt during a crash or emergency stop can be thrown against the inside of the vehicle, against other occupants, or out of the vehicle.
- **Each seat belt is designed to restrain one occupant.** If more than one person uses the same seat belt, they could be seriously injured or killed in a collision.
- **Do not use any accessories on seat belts.** Devices claiming to improve occupant comfort or reposition the seat belt can reduce the protection provided by the seat belt and increase the chance of serious injury in a crash.
- **Passengers should not place hard or sharp objects between themselves and the air bags.** Carrying hard or sharp objects on your lap or in your mouth can result in injuries if an air bag inflates.
- **Keep occupants away from the air bag covers.** All occupants should sit upright, fully back in their seats with their seat belts on and their feet on the floor. If occupants are too close to the air bag covers, they could be injured if the air bags inflate.
- **Do not attach or place objects on or near the air bag covers.** Any object attached to or placed on the front or side air bag covers could interfere

with the proper operation of the air bags.

- **Do not modify the front seats.** Modification of the front seats could interfere with the operation of the supplemental restraint system sensing components or side air bags.
- **Do not place items under the front seats.** Placing items under the front seats could interfere with the operation of the supplemental restraint system sensing components and wiring harnesses.
- **Never hold an infant or child on your lap.** The infant or child could be seriously injured or killed in the event of a crash. All infants and children should be properly restrained in appropriate child safety seats or seat belts in the rear seat.

WARNING

- Sitting improperly or out of position can cause occupants to be shifted too close to a deploying air bag, strike the interior structure or be thrown from the vehicle resulting in serious injury or death.
- Always sit upright with the seatback in an upright position, centered on the seat cushion with your seat belt on, legs comfortably extended and your feet on the floor.

Adding equipment to or modifying your air bag-equipped vehicle

Modifying your vehicle by changing your vehicle's frame, bumper system, front end or side sheet metal, or ride height may affect the operation of your vehicle's air bag system.

Air bag warning labels

Left-hand drive



Right-hand drive

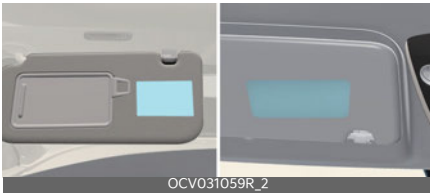

Air bag warning label



Air bag warning labels are attached to alert the passengers to potential risks of the air bag system.

Note that these government warnings focus on the risks to children. We also want you to be aware of the risks that adults are exposed to, which have been described in previous pages.

⚠ WARNING

- Never place a rear facing child restraint in the front passenger seat, unless the passenger-side air bag is deactivated. An inflating passenger-side air bag could impact the rear-facing child restraint and kill the child.

- Extreme Hazard! Do not use a rearward facing child restraint on a seat protected by an air bag in front of it!
- Never put a child restraint in the front passenger's seat. If the front passenger air bag inflates, it can cause serious or fatal injuries.
- NEVER use a rearward facing child restraint on a seat protected by an ACTIVE AIR BAG in front of it, DEATH or SERIOUS INJURY to the CHILD can occur.
- When children are seated in the rear outboard seats of a vehicle equipped with side and/or curtain air bags, be sure to install the child restraint system as far away from the door side as possible, and securely lock the child restraint system in position.

Inflation of side and/or curtain air bags could cause serious injury or death to an infant or child.

*** NOTICE**

If equipped with rollover sensor

- The air bags inflate instantly in the event of a rollover (if equipped with a side air bag or curtain air bag) in order to help protect the occupants from serious physical injury.
- The side and/or the curtain air bag may deploy when the rollover sensor detects the situation as a rollover.

Features of your vehicle **5**

Keys	5-6
• Record your key number.....	5-6
• Locking/unlocking/remote starting/remote parking with the smart key.....	5-6
• Replacing the key battery.....	5-7
Immobilizer system	5-8
• Vehicles with smart key system.....	5-8
Theft-alarm system	5-9
• Armed stage.....	5-9
• Ultrasonic Intrusion Protection (UIP).....	5-9
• Theft-alarm stage.....	5-9
• Disarmed stage.....	5-10
Door locks	5-11
• Door locks outside the vehicle.....	5-11
• Door locks inside the vehicle.....	5-13
• Automatic door lock and unlock features.....	5-14
• Deadlocks.....	5-15
• Manual door lock switch.....	5-15
• Rear door locks.....	5-16
• Rear Occupant Alert (ROA).....	5-17
Driver position memory system	5-19
• Setting memory position.....	5-19
• Recalling memory position.....	5-19
• Resetting the driver position memory system.....	5-19
• Easy access function.....	5-19
Tailgate	5-20
• Opening/closing the manual tailgate.....	5-20
• Opening/closing the power tailgate.....	5-21
Windows	5-28
• Controlling windows switch.....	5-30

5 Features of your vehicle

• Resetting the power windows.....	5-30
• Power windows automatic reversal.....	5-30
• Power windows lock button.....	5-30
• Remote window closing/opening.....	5-31
Hood.....	5-32
• Opening/closing the hood.....	5-32
Front trunk.....	5-33
• Opening the front trunk.....	5-33
• Closing the front trunk.....	5-33
Charging door.....	5-34
• Opening/closing the charging door.....	5-34
Wide sunroof.....	5-36
• Power sunshade.....	5-36
• Tilt open/close.....	5-37
• Slide open/close.....	5-37
• Automatic reversal.....	5-37
• Resetting the sunroof.....	5-38
• Sunroof open warning.....	5-39
Steering wheel.....	5-39
• Adjusting the steering wheel angle and height.....	5-39
• Heated steering wheel.....	5-39
• Horn.....	5-40
Mirrors.....	5-42
• Interior rearview mirror.....	5-42
• Outside rear view mirror.....	5-42
Instrument cluster.....	5-45
LCD display.....	5-47
• Changing LCD display modes.....	5-47
• LCD display modes.....	5-47
• LCD display messages.....	5-51

Features of your vehicle **5**

Vehicle settings (infotainment system)	5-53
Warning and indicator lights	5-54
Augmented Reality HUD	5-58
• Head-up display settings.....	5-58
• Head-up display information.....	5-58
• Precautions while using the head-up display	5-59
Lighting	5-60
• Battery saver function.....	5-60
• Headlamp escort function.....	5-61
• Daytime Running Light (DRL).....	5-61
• Traffic change (For Europe)	5-61
• Lighting controls.....	5-62
• High Beam Assist (HBA).....	5-63
• Intelligent front-lighting system (IFS).....	5-66
• Headlamp leveling adjustment.....	5-68
Wipers and washers	5-68
• Wipers	5-68
• Washers.....	5-69
Welcome system	5-70
• Body silhouette lamp.....	5-70
• Headlamp escort function.....	5-70
• Interior lighting.....	5-71
Interior lights	5-71
• Automatic turn-off function	5-71
• Map lamp.....	5-71
• Room lamp.....	5-72
• Luggage space lamp	5-72
• Vanity mirror lamp	5-72
• Glove box lamp.....	5-72
Climate control system	5-73

5 Features of your vehicle

Automatic climate control system	5-76
• Using the infotainment/climate switchable controller	5-77
• Operating the climate control system	5-78
• Controlling heating and air conditioning automatically	5-81
• Controlling the temperature	5-81
• Adjusting the driver and passenger side temperature to the same value	5-81
• Changing temperature scale	5-82
• Controlling fan speed.....	5-82
Windshield defrosting and defogging	5-83
• Defrosting/defogging the windshield	5-83
• Auto defogging for automatic climate control	5-83
• Rear window/outside mirror defroster	5-84
• Heat button.....	5-84
• Auto. controls that use climate control settings.....	5-85
• Smart ventilation	5-86
Storage compartment	5-86
• Center console storage/glove box	5-86
• Luggage tray	5-87
• Luggage net holder.....	5-87
• Cargo security screen	5-87
Interior features	5-89
• Ambient lights	5-89
• Cup holders	5-89
• Seat warmer/ventilation.....	5-89
• Sun visor	5-91
• USB charger	5-91
• Power outlet	5-92
• Wireless smartphone charging system.....	5-93
• Coat hook	5-94
• Floor mat anchors.....	5-95

Infotainment system	5-95
• Using the infotainment/climate switchable controller.....	5-95
• Audio system.....	5-96

Features of your vehicle

* The information provided may differ according to which functions are applicable to your vehicle.

Keys

Record your key number

The key code number is stamped on the key code tag attached to the key set.

If you lose your keys, Kia recommends contacting an authorized Kia dealer/service partner. Remove the key code tag and store it in a safe place. Also, record the key code number and keep it in a safe place (not in the vehicle).

Locking/unlocking/remote starting/remote parking with the smart key

Smart key



- 1 Lock
- 2 Unlock
- 3 Tailgate unlock/open
- 4 Remote start
- 5 Remote Start Parking Assist (Forward)
- 6 Remote Start Parking Assist (Backward)

Operation

- Press the corresponding button.
- Press the door lock button (1) and hold the remote start button (4) for 2 seconds to start the vehicle remotely.
- Press the forward/backward buttons (5, 6) to move the vehicle forward/backward.

Non-operating condition(s)

- Being close to a radio transmitter such as a radio station or an airport which can interfere with normal operation of the smart key.
- Being near a mobile two-way radio system or a cellular phone.
- Another vehicle's smart key is being operated close to your vehicle.

* INFORMATION

- If you press the tailgate unlock/open button for longer than a second, the lock will be released or the tailgate will be opened according to the options of the vehicle.
- If any door, hood or tailgate remains open, the hazard warning lights will not operate.
- After pressing unlock button, the doors will lock automatically unless you open any door within 30 seconds.
- After pressing the Lock/Unlock button, The hazard warning lights will flash.
- To start the vehicle remotely, the smart key should be detected within 10 m (32 ft) distance from the vehicle, and the remote start button should be pressed within 4 seconds after the doors are locked.

- If no further action for operating/driving the vehicle is taken, the vehicle will be turned off 10 minutes after starting the vehicle remotely.
- The driver can move the vehicle forward or backward using the forward/backward buttons (5, 6) on the smart key. For more details of Remote Smart Parking Assist (RSPA), refer to "Remote Smart Parking Assist (RSPA) (if equipped)" on page 6-159.

Removing the mechanical key from the smart key

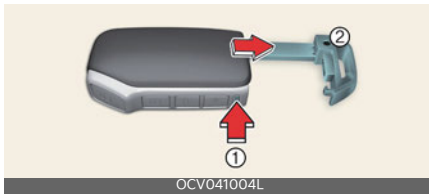

- 1 Tab
- 2 Mechanical key

Operation

1. Press and hold the tab (1).
2. Pull the mechanical key (2) out.

Replacing the key battery



Operation

1. Pry open the key cover gently.
2. Replace the old battery with a new battery.

* INFORMATION

The battery is CR2032 (3V).

⚠ WARNING

- Never leave the keys in your vehicle with unsupervised children. Leaving children unattended in a vehicle with the Smart key is dangerous even if the EV button is not in the ACC or ON position. Children copy adults and they could press the EV button. The key would enable children to operate power windows or other controls, or even make the vehicle move, which could result in serious bodily injury or death.

• THIS PRODUCT CONTAINS A BUTTON BATTERY

If swallowed, a lithium button battery can cause severe or fatal injuries within 2 hours.

Keep batteries out of reach of children.

If you think batteries may have been swallowed or placed inside any part of the body, seek immediate medical attention.

⚠ CAUTION

- The smart key is designed to give you years of trouble-free use, however it can malfunction if exposed to moisture or static electricity. If you are unsure how to use or replace the battery, Kia recommends to contact an authorized Kia dealer/service partner.
- Using the wrong battery can cause the smart key to malfunction. Be sure to use the correct battery.

- To avoid damaging the smart key, don't drop it, get it wet, or expose it to heat or sunlight.



- An inappropriately disposed battery can be harmful to the environment and human health. Dispose the battery according to your local law(s) or regulation.

*** NOTICE**

- If, for some reason, you happen to lose your smart key, you will not be able to start the vehicle. Tow the vehicle, if necessary, contact a professional workshop. Kia recommends to contact an authorized Kia dealer/service partner.
- A maximum of 2 smart keys can be registered to a single vehicle. If you lose a smart key, Kia recommends to contact an authorized Kia dealer/service partner.
- When the smart key does not work properly, open and close the door with the mechanical key. If you have a problem with the smart key, Kia recommends to contact an authorized Kia dealer/service partner.
- If the smart key is not moved for some time, the detection function for smart key operation will pause. Lift the smart key to activate the detection again.

Immobilizer system

The immobilizer system checks, determines, and verifies the key whenever the vehicle is in the ON position.

Whenever the EV button is changed to the ON position, the immobilizer system checks and verifies if the key is valid or not.

If the key is valid, the vehicle will start.

If the key is invalid, the vehicle will not start.

Vehicles with smart key system

Deactivating the immobilizer system

Operation

- Change the EV button to the ON position.

Activating the immobilizer system

Operation

Change the EV button to the OFF position. The immobilizer system activates automatically. Without a valid smart key for your vehicle, the vehicle will not start.

⚠ WARNING

In order to prevent theft of your vehicle, do not leave spare keys anywhere in your vehicle. Your immobilizer password is a customer unique password and should be kept confidential. Do not leave this number anywhere in your vehicle.

⚠ CAUTION

- Do not put metal accessories near the EV button. Metal accessories may interrupt the transponder signal and

may prevent the vehicle from being started.

- The transponder in your EV button is an important part of the immobilizer system. It is designed to give years of trouble-free service, however you should avoid exposure to moisture, static electricity and rough handling. Immobilizer system malfunction could occur.
- Do not change, alter or adjust the immobilizer system because it could cause the immobilizer system to malfunction. In this case, have the system serviced by a professional workshop. Kia recommends visiting an authorized Kia dealer/service partner. Malfunctions caused by improper alterations, adjustments or modifications to the immobilizer system are not covered by your vehicle manufacturer warranty.
- Do not attempt to alter this system or add other devices to it. Electrical problems could result that may make your vehicle inoperable.

* NOTICE

- When starting the vehicle, do not use the key with other immobilizer keys around. Otherwise the vehicle may not start or may stop soon after it starts. Keep each key separately in order to avoid a starting malfunction.
- If you need additional keys or lose your keys, Kia recommends visiting an authorized Kia dealer/service partner.

Theft-alarm system



The system provides an audible alarm and the hazard warning lights blink if triggered. The system is operated in 3 stages.

Do not attempt to alter this system or add other devices to it.

Armed stage

Operation

- Lock the doors by pressing the lock button on the key or door handle.

Operating condition(s)

- 30 seconds after the doors are locked.
- Vehicle in OFF position or key removed from the vehicle.
- All doors closed and locked.

Ultrasonic Intrusion Protection (UIP) (if equipped)

Ultrasonic Intrusion Protection provides an alert when movement is detected in the passenger compartment after the vehicle is locked.

Operation

- Select **Settings** → **Vehicle** → **Convenience** → **Advanced anti-theft** in the infotainment system screen.

Theft-alarm stage

Operation

- The horn will sound and the hazard warning lights will blink continuously for approximately 30 seconds. To turn off the system, unlock the doors with the smart key.

Operating condition(s)

- When Ultrasonic Intrusion Protection (UIP) is off:
 - A front or rear door is opened without using the smart key.
 - The tailgate is opened without using the smart key.
 - The hood is opened.
 - The vehicle is in the ON position.
- When Ultrasonic Intrusion Protection (UIP) is on:
 - The passenger(s) moves in the vehicle.
 - The inclination of the vehicle is changed to the certain degree.
 - A front or rear door is opened without using the smart key.
 - The tailgate is opened without using the smart key.
 - The hood is closed.
 - The vehicle is in OFF position.

Disarmed stage

Operating condition(s)

- Door unlock button is pressed.
- The vehicle is started.
- Outside door handle button is pressed.

CAUTION

- Do not change, alter or adjust the theft-alarm system because it could cause the theft-alarm system to malfunction. In this case, have the system serviced by a professional workshop. Kia recommends visiting an authorized Kia dealer/service partner. Malfunctions caused by improper alterations, adjustments or modifications to the theft-alarm system are

not covered by your vehicle manufacturer warranty.

- Do not attempt to alter this system or add other devices to it. Electrical problems could result that may make your vehicle inoperable.
- Do not activate the Ultrasonic Intrusion Protection if there are any chances the vehicle tilts by the outward influences (for example, ferry boat traveling, tower parking etc.), because it could cause the siren to sound inadvertently.
- Make sure all windows are close whilst the system operates. If not, the Ultrasonic Intrusion Protection detects the inadvertent movement inside the vehicle (for example, blowing a wind or entering a butterfly) and it makes the siren sounds.
- If boxes are piled high in the vehicle, the Ultrasonic Intrusion Protection may not detect the movement behind the boxes. Also the boxes may drop and it makes the siren sounds.
- If the Ultrasonic Intrusion Protection is stained with foreign matter such as cosmetics, spray type air freshener, or spray type window cleaner, the sensor may not operate normally.

NOTICE

- Ultrasonic Intrusion Protection is in ON position whenever the vehicle is started again.
- Avoid trying to start the vehicle while the alarm is activated. If the system is not disarmed with the key, turn the vehicle to the ON position and wait for 30 seconds. Then the system will be disarmed.

Door locks

Door locks outside the vehicle

Locking/unlocking with the smart key (Manual type)



Operation

- Press the front door handle button (driver's side).
- Hazard warning lights will blink.
 - Locking: Once
 - Unlocking: Twice
- In addition, pushing the button on the door handle (the engraved part) while keeping the smart key will lock all doors.

Non-operating condition(s)

- Smart key is in the vehicle.
- The vehicle is in the ACC or ON position.
- Any of the doors are open except for the tailgate.

Limitation(s)

- Smart key is detected within 0.7~1 m radius (28~40 inches).

* INFORMATION

The chime will sound for 3 seconds.

Locking/unlocking with the smart key (Electric type) (if equipped)



The outside door handle will slide out and the doors will unlock when the driver approaches the vehicle possessing the smart key. (Approach unlock system)

Operation

1. Select **Settings** → **Vehicle** → **Door** → **Approach unlock** in the infotainment system screen.
2. The outside door handle will pop out and the door will unlock when the driver approaches the vehicle possessing the smart key.

* INFORMATION

- The driver can activate/deactivate the **Approach unlock** system on the infotainment screen.
- In emergency situations, such as battery is dead, the outside electric door handle can still be operated in a way that the outside manual door handle operate.
- If Approaching unlock system is deactivated, the door handle will not pop out even when the driver approaches to the vehicle with the smart key. To unlock doors when Approach unlock system is deactivated, touch the lock/unlock sensor on the handle.

- Press the lock button on the smart key and hold the lock and unlock button simultaneously for more than approximately 4 seconds to prevent unintentional door lock/unlock. The hazard warning lights will blink 4 times. The doors will not lock or unlock even though the touch sensor is touched on the outside door handle. Press the door lock or unlock button on the smart key to deactivate the function.
- When washing the vehicle
 - Self car wash
Keep the door locked with the outside door handle closed. To keep the door unlocked, push back the outside door handle by hand. This function prevents the door handle from being damaged, and the door handle pops out again when the unlock button is pressed.
 - Auto car wash
Keep the door locked with the outside door handle closed. If the smart key is not in the vehicle, turn off the vehicle and stay the smart key away at least 2 m (78 inches) from the vehicle to prevent the outside door handle operates.

Locking/unlocking with mechanical key



- 1 Tab
- 2 Key

Operation

1. Press the front part (1) of the door handle to pull out the rear part of the door handle.
2. Insert the key with the sharp edge side on the ground direction (2). The surface of the panel can be damaged if it's on opposite direction.
3. Turn the key.
 - Locking: Left
 - Unlocking: Right

How to remove ice from door handles

In extreme winter conditions, the door handle may not open due to icing inside the door handle. You can usually use the bottom of your fist to tap the door handle a few times to remove the ice.

1. Remove icing by tapping the door handle using the bottom of your fist in a circular pattern along the perimeter of the door handle.



2. If necessary, increase the intensity of tapping to remove ice, and repeat until the door handle protrudes when unlocking the door.
3. When the door handle protrudes and can be pulled, open and close a few times to remove any icing residue.

⚠ WARNING

- Before performing this procedure, remove any jewelry or objects that could damage the paintwork and do

not attempt to use tools or excessive force.

- Do not hit the vehicle too hard as dents may occur. You should use a force similar to knocking on your neighbor's door.

*** NOTICE**

- When locking the door with a mechanical key, be aware that only the driver's door can be locked/unlocked.
- To lock all doors, operate the central lock switch inside the vehicle. Open the car door using the inner handle, then close the door and lock the driver's door with a mechanical key.
- Refer to "Door locks inside the vehicle" on page 5-13 to lock from inside the vehicle.
- Be careful not to lose or scratch the door handle.
- Do not apply excessive force to the door and door handle. It may be damaged.

Door locks inside the vehicle

Unlocking with the door handle



Operation

- Pull the door handle.
 - Front door: Once
 - Rear door: Twice

Locking/unlocking with the central locking switch



- 1 Door lock button
- 2 Door unlock button
- 3 Door indicator light

Operation

- Press the corresponding button below.
 - Button (1): Lock
 - Button (2): Unlock

*** INFORMATION**

- When all vehicle doors are locked, the door indicator light (3) on the driver's door and passenger's door will turn on. If any door is unlocked, it would go off.
- If the smart key is in the vehicle and any door is opened, the doors will not lock even though the central door lock switch is pressed.

⚠ WARNING

- If a power door lock ever fails to function while you are in the vehicle, try one or more of the following techniques to exit:
 - Operate the door unlock feature repeatedly (both electronic and manual) while simultaneously pulling on the door handle.
 - Operate the other door locks and handles, front and rear.

- Lower a front window and use the mechanical key to unlock the door from outside.
- Move to the cargo area and open the tailgate.
- Do not pull the inner door handle of driver's (or passenger's) door while the vehicle is moving.
- The doors should always be fully closed and locked while the vehicle is in motion to prevent accidental opening of the door. Locked doors will also discourage potential intruders when the vehicle stops or slows down.
- Be careful when opening doors and watch for vehicles, motorcycles, bicycles or pedestrians approaching the vehicle in the path of the door. Opening a door when something is approaching can cause damage or injury.
- Leaving your vehicle unlocked can invite theft or possible harm to you or others from someone hiding in your vehicle while you are gone. Always remove the smart key, engage the parking brake, close all windows and lock all doors when leaving your vehicle unattended.
- **Unattended children, the elderly or pets**

An enclosed vehicle can become extremely hot, causing death or severe injury such as heatstroke to unattended children, the elderly or pets who cannot escape the vehicle. When left or trapped in a hot vehicle, make sure to stay hydrated and avoid sun exposure through the vehicle's windshield. Furthermore, children might operate features of the vehicle that could injure them, or they could encounter other harm, possibly from

someone gaining entry to the vehicle. Never leave children or animals unattended in your vehicle.

CAUTION

When you leave your vehicle with the smart key, make sure to press the button on the front door handle or touch the touch sensor on the front door handle to lock the doors after close all of the doors, the hood and the trunk. If you do not press the button or touch the touch sensor firmly, the doors might not be locked so please use caution.

NOTICE

- The outside rearview mirror will fold or unfold if **On door unlock** is selected from the Settings menu in the infotainment system screen. Select:
 - **Settings** → **Vehicle** → **Convenience** → **Welcome mirror/light** → **On door unlock**
- The doors may lock or unlock if the touch sensor of the outer door handle is recognized while washing your car or due to heavy rain.
- The doors may not lock or unlock in the following situations:
 - If the touch sensor is touched with gloves on
 - If the door is suddenly approached

Automatic door lock and unlock features

Your vehicle is equipped with features that will automatically lock or unlock your vehicle based on settings you select in the infotainment system screen.

Auto lock enable on speed

When this feature is set in the infotainment system screen, all the doors will be locked automatically when the vehicle exceeds 15 km/h (9 mph).

Auto lock enable on shift

When this feature is set in the infotainment system screen, all the doors will be locked automatically when the vehicle is shifted out of P (Park) while the vehicle is running.

Auto unlock on shift to P

When this feature is set in the infotainment system screen, all the doors will be unlocked automatically when the vehicle is shifted out of P (Park) while the vehicle is running.

Auto unlock vehicle off

When this feature is set in the infotainment system screen, all the doors will be unlocked automatically when the vehicle is turned off.

Impact sensing door unlock system

All doors will automatically unlock when an impact causes the air bags to deploy.

Additional unlock safety feature air bag deployment

When this feature is set in the infotainment system screen, all the doors will be unlocked automatically when the vehicle is turned off.

Deadlocks (if equipped)

Some vehicles are equipped with dead-lock system. Deadlocks prevent opening of a door from either inside or outside the vehicle once the deadlocks have been activated providing an additional measure of vehicle security.

To lock the vehicle using the dead lock function, the doors must be locked by using the smart key. To unlock the vehicle, the smart key must be used again.

Manual door lock switch



Operation

1. Open the door.
2. Insert the mechanical key.
3. Turn the key to the lock position.
4. Close the door securely.

Operating condition(s)

- The power door lock switch is not operating.

* NOTICE

If the electrical power to door lock switch is not operating (ex. dead car battery) and the tailgate is closed, you will not be able to open the tailgate until power is restored.

Rear door locks

Child-protector rear door lock (if equipped)

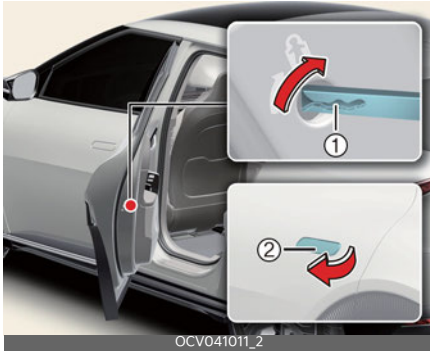

Operation

1. Insert the mechanical key.
2. Turn the child safety lock to the lock position (1).
3. To open the rear door, pull the outside door handle (2).

Electronic child safety lock system (if equipped)

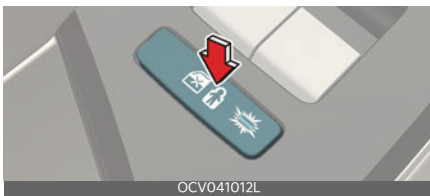

Operation

- Push the electronic child safety lock button.

* INFORMATION

- If you push the electronic child safety lock switch and the indicator illuminates, rear passengers cannot open the rear door from inside the vehicle.

- Safe Exit Assist (SEA) does not automatically activate the electronic child safety lock system. If your vehicle is equipped with the Electronic child safety lock, the child-protector rear door locks, which are manually operated, are not provided.
- If 3 minutes passes after the EV button is pressed to the OFF or ACC position, the indicator on the button turns off, and the driver cannot turn off electronic child safety lock by pressing the button. To turn off the function, press the EV button to the ON position, and then press the electronic child safety lock button.

⚠ WARNING

- If children accidentally open the rear doors while the vehicle is in motion, they could fall out and be severely injured or killed. To prevent children from opening the rear doors from the inside, the rear door safety locks should be used whenever children are in the vehicle.
- The system does not detect every obstacle approaching the vehicle exit.
- The driver and passenger are responsible for the accident occurred while exiting the vehicle. Always check the surrounding before you exit the vehicle.

⚠ CAUTION

If the electronic child safety lock is not operated when pushing the electronic child safety lock switch, the message is displayed and the alarm will sound.

If this occurs, have the system checked by a professional workshop. Kia recom-

mends visiting an authorized Kia dealer/service partner.

Rear Occupant Alert (ROA)

The Rear Occupant Alert (ROA) is provided to help prevent exiting the vehicle with a rear passenger left in the vehicle.



Operation

- Select **Settings** → **Vehicle** → **Convenience** → **Rear Occupant Alert** on the infotainment system screen.

* For detailed information, refer to Navigation Quick Reference Guide.

1st alert operation

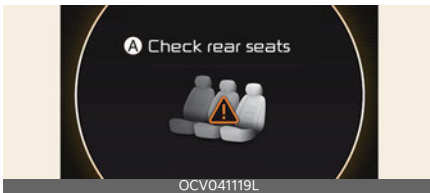

A: Check rear seats

When you turn off the vehicle and open the driver's door after opening and closing the rear door or tailgate, the warning message appears on the cluster.

2nd alert operation

After the first alert, the second alert operates when any movement is detected in the vehicle after the driver's door is closed and all the doors are locked. The horn will sound for approximately 25 seconds. Also, a text message is sent to members of Kia Connect Services (if equipped). If the system continues to detect a movement, the alert operates up to 8 times. Unlock the doors with the smart key to stop the alert.

The system detects movement in the vehicle for 10 minutes after the door is locked.

Rear Occupant Alert (ROA) precautions

- Make sure that all the windows are closed. If the window is open, the alert may operate by the sensor detecting an unintended movement (e.g. wind or bugs).
- The alert may operate if movement in the driver or passenger seat is detected.
- If the doors are locked with a passenger inside the vehicle, the alert may operate.
- An alert can occur if there is an impact on the vehicle.
- If boxes or objects are stacked in the vehicle, the system may not detect the boxes or objects. Or, the alert may operate if the boxes or objects fall off.
- The alert may operate with the doors locked due to car wash or surrounding vibration or noise.
- The alert may operate when there are metallic or liquid objects in the vehicle.

⚠ WARNING

Even if your vehicle is equipped with Advanced Rear Occupant Alert (ROA), always make sure to check the rear seat before you leave the vehicle. Advanced Rear Occupant Alert (ROA) may not operate when:

- Movement does not continue for a certain period of time or the movement is small.
- A child is not seated in a child restraint system.
- Movement is detected in areas other than the rear seats.
- The rear passenger is covered with a fabric containing metallic substance such as a blanket.
- An object in the vehicle blocks the sensor.
- The sensor is contaminated by foreign material.
- An animal at the rear seat or luggage compartment is not large enough to be detected by the sensor or there is hardly any movement.
- Attaching objects or modifying the interior ceiling, or the interior ceiling is deformed or damaged.
- There are electronic interference around the vehicle.
- Other environmental reasons that may affect the system.

*** NOTICE**

- The second alert is activated only after the prior activation of the first alert.
- The second alert activates only when the sensor is equipped in the vehicle.
- If you do not want to use Rear Occupant Alert, press the OK button on the steering wheel when the first alert is displayed on the cluster. Doing so will deactivate the second alert one time.

**A: Check rear seats**

- If the vehicle is started remotely (if equipped with Remote Start), inside movement detection will stop.

Declaration of conformity

The radio frequency components (ROA Radar Sensor) complies:
For Europe and CE certified countries

Declaration of Conformity
Radiocontrolled Vehicle components



We, IEE International Electronics & Engineering, abbreviated 'IEE S.A.', a Luxembourg société anonyme, having its registered office at Zone Industrielle, 12 rue Pierre Richardot, L-6468 Echternach, Grand-Duchy of Luxembourg and registered with the Luxembourg Trade and Companies' Register under number B 134858, declare under our sole responsibility that the above named product is in conformity with the relevant Union harmonisation legislation:

- 2011/65/EU - European RoHS Directive
- 2014/53/EU - Radio Equipment Directive

The original declaration of conformity can be consulted at: IEE S.A., Legal Department, 1 rue du Campus, L-7795 Bissen, Luxembourg.

Frequency band 60-64 GHz
Maximum Output Power 13 dBm (20 mW)

OCV052280L

Driver position memory system (if equipped)

Setting memory position



Operation

- Adjust the following positions:
 - Driver's seat position (if equipped)
 - Wing mirror position (if equipped)
 - Head-Up Display (HUD): display mode, position, AR matching adjustment (if equipped)
- Press '1' or '2' button.
 - Within approximately 4 seconds
 - Chime twice

* INFORMATION

The vehicle should be in the ON position to use this function.

Recalling memory position

Operation

- Press the '1' or '2' button.
 - Chime once
- Stored positions will be adjusted.

Resetting the driver position memory system

Operation

1. Shift to P (Park) while the EV button is in the ON position.
2. Move the driver seat as forward as possible.
3. Move the seatback to a fully upright position.
4. Press the '1' button and seat forward movement switch simultaneously for approximately 2 seconds.

Initialization

- The seat and seatback will move backwards.
 - Chime continues
- The seat and seatback will move to the center position.
 - Chime stops

Easy access function

Operating condition(s)

- Driver's seat moves backward when:
 - The vehicle is in the OFF position
 - The driver door is opened
- Driver's seat moves forward when:
 - The vehicle is in the ACC or ON position
 - The driver door is closed when you have the smart key with you.

* INFORMATION

- You can activate or deactivate the Easy Access Function from Vehicle Settings from the infotainment system screen. For more details, refer to Navigation Quick Reference Guide.

⚠ WARNING

Never attempt to operate the driver position memory system while the vehicle is moving. This could result in loss of control, and an accident causing death, serious injury, or property damage.

* NOTICE

- If the battery is disconnected, the memory settings will be erased.
- If the Driver Position Memory System does not operate normally, we recommend that you have the system checked by an authorized Kia dealer/service partner.

Tailgate

Opening/closing the manual tailgate



Operation

- Press the outside handle switch (1) to open the tailgate.
- Pull up the tailgate.
- Push down the tailgate to close the tailgate. Make sure that the tailgate is securely latched.

Operating condition(s)

- The tailgate is locked or unlocked using the key or central door lock switch.

Opening/closing the power tailgate (if equipped)

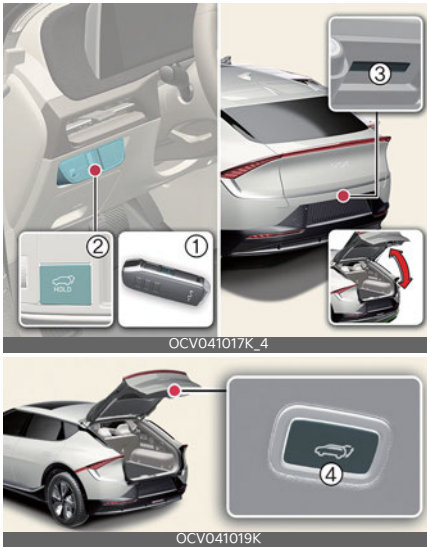

Operation

- **Power tailgate open/close button - smart key (1)/inside the vehicle (2)**

When the tailgate is closed, press and hold the power tailgate open/close button. The tailgate will open automatically and the warning chime will sound. Press the tailgate open/close button again to stop the operation.

When the tailgate is opened, press and hold the power tailgate open/close button. The tailgate will close automatically and the warning chime will sound. Press the power tailgate open/close button until the tailgate is closed completely. If the tailgate open/close button is not pressed while closing, power tailgate will stop operate and warning chime will sound for approximately 5 seconds.

- **Power tailgate open button - outside the vehicle (3)**

When the smart key is detected, press the power tailgate open button. The tailgate will open and the warning chime will sound. If the doors are unlocked, the tailgate can be opened or closed without the smart key.

- **Power tailgate close button - inside the vehicle (4)**

Press the power tailgate close button. The tailgate will close and the warning chime will sound.

Operating condition(s)

- The vehicle is in the ON position and the vehicle gear is in P (Park).
- The vehicle is in OFF position.
- Smart key is carried.

Non-operating condition(s)

- Vehicle speed is above 3 km/h (2 mph).

* INFORMATION

Only the power tailgate opening will not operate if the vehicle speed is above 3 km/h (2 mph).

Power tailgate automatic reversal

The power tailgate will open again automatically if the power tailgate is blocked by an object or a part of the body.

If the resistance is detected while opening and closing the tailgate, it will stop and move in the opposite direction.

⚠ WARNING

- Make sure the vehicle is in P (Park) and set the parking brake.
- Occupants should never ride in the rear cargo area where no restraints are available. To avoid injury in the event of an accident or sudden stops, occupants should always be properly restrained.
- The tailgate swings upward. Make sure no objects or people are near the rear of the vehicle when opening the tailgate.
- Make sure your hands, feet and other parts of your body are safely out of the way before closing the tailgate.
- Never leave children or animals unattended in your vehicle. Children or animals might operate the power tailgate that could result in injury to themselves or others, or damage the vehicle.
- Make sure there are no people or objects around the tailgate before opening or closing the power tailgate. Wait until the tailgate is open fully and stopped before loading or unloading cargo from the vehicle.

- Make sure that there are no people or objects in the path of the power tailgate (or smart tailgate) prior to use. Serious injury, damage to the vehicle or damage to surrounding objects may result if contact with the power tailgate (or smart tailgate) occurs.



- A: 70 cm
- B: 70 cm
- The chime will sound continuously if you drive over 3 km/h (2 mph) with the tailgate opened. Stop your vehicle immediately at a safe place and check if your tailgate is opened.
- Never intentionally place any object or part of your body in the path of the power tailgate to make sure the automatic reversal operates.
- Never operate power tailgate attached with any heavy objects (ex. bicycles). It could damage the power tailgate.

⚠ CAUTION

- Make certain that you close the tailgate before driving your vehicle. Possible damage may occur to the tailgate gas lifters and attached hardware if the tailgate is not closed prior to driving.
- Make sure nothing is near the tailgate latch and striker while closing the tailgate. It may damage the tailgate's latch.
- Be careful when opening and closing the tailgate or inserting and removing

objects, as body or objects may be injured or damaged if they are hit by sharp edges, such as corners. Children may get hurt if their face, head, etc. hit the area around the tailgate, so always be aware.

- Do not close or open the power tailgate manually. This may cause damage to the power tailgate. If it is necessary to close or open the power tailgate manually when the battery is discharged or disconnected, do not apply excessive force.
- Do not operate the power tailgate more than 5 times continuously. It may damage the power tailgate system. If the spindle is strained due to continuous operation, the chime will sound 3 times and the power tailgate will not operate. At this time, stop operating the tailgate and leave it for more than 1 minute.
- Do not modify or repair any part of the power tailgate by yourself. Kia recommends visiting an authorized Kia dealer/service partner.
- When jacking up the vehicle to change a tire or repair the vehicle, do not operate the power tailgate. This could cause the power tailgate to operate improperly.
- In cold and wet climates, the power tailgate may not work properly due to freezing conditions.
- In cold and wet climates, door lock and door mechanisms may not work properly due to freezing conditions.
- Power tailgate may stop operating when more than one operation is detected while opening/closing. In this case, open/close the tailgate manually and operate the power tailgate function.

* NOTICE

- Do not put heavy stuffs on the power tailgate when you operate the power tailgate. Additional weight on tailgate could cause damages to the system.
- If The vehicle is in the ON position, the power tailgate can operate when P (Park) gear position is selected.
- The power tailgate can be operated when the vehicle is not running. However the power tailgate operation consumes large amounts of vehicle electric power. To prevent the battery from being discharged, do not operate it excessively e.g. more than approximately 10 times repeatedly.
- To prevent the battery from being discharged, do not leave the power tailgate in the open position for a long time.

Setting power tailgate

Operation

- Select **Settings** → **Vehicle** → **Door** → **Power tailgate** on infotainment system.

Adjusting power tailgate speed

Operation

- Select **Settings** → **Vehicle** → **Door** → **Power tailgate opening speed** → **Normal/Fast** on the infotainment system.
- The initial setting is set to **Fast**.

Adjusting power tailgate opening height

Operation

- Select **Settings** → **Vehicle** → **Door** → **Power tailgate opening height** → **Level 1/Level 2/Level 3/Full open/ User height setting** on infotainment system.

Adjusting User Height Setting

Operation

1. Adjust the tailgate to the preferred height.
2. Press the power tailgate close button for approximately 3 seconds until the alarm is heard.

* NOTICE

- If the tailgate opening height is adjusted manually, the settings for the infotainment system will change to **User height setting**.
- The tailgate opening height will be same as **Full open** before **User height setting** is set.
- If **User height setting** is selected after **Full open/Level 3/Level 2/Level 1**, the previous user height setting will be set.

Resetting the power tailgate

Operation

1. Turn the vehicle OFF or shift to P (Park) or N (Neutral).
2. Press the power tailgate open button to open the power tailgate.
3. Press and hold the inside tailgate close button first and outside tailgate open button simultaneously for more

than 3 seconds and the chime will sound.

4. Close the tailgate manually.
5. Press the power tailgate open button on the outside of the vehicle.
6. The tailgate will open and the chime will sound.
7. If the tailgate is stopped before it is fully open, resetting will not proceed. Wait until the tailgate is open fully and stopped.

Operating condition(s)

- Vehicle is in P (Park) position.

* NOTICE

- If the power tailgate does not operate normally, check again if the gear is in the correct position.
- The power tailgate needs to be reset in following conditions:
 - The battery (12V) is recharged
 - The battery (12V) is reassembled
 - Related fuse is reassembled

Opening the smart tailgate (if equipped)

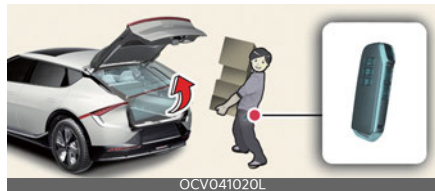

Operation

- Select **Settings** → **Vehicle** → **Door** → **Smart tailgate** on the infotainment system.

Operating condition(s)

- After 15 seconds when all doors are closed and locked.
- Positioned in the detecting area for more than 3 seconds.
- Disconnecting the charging connector

Non-operating condition(s)

- The Smart Key is detected less than 15 seconds after the doors are closed and locked and is continuously detected.
- The Smart Key is detected less than 15 seconds after the doors are closed and locked and 1.5 m from the front door handles (for vehicles equipped with Welcome Light).
- A door is not locked or closed.
- The smart key is in the vehicle.
- The vehicle is on charge

Limitation(s)

- Smart key is not detected within 50~100 cm (28~40 inches) radius behind the vehicle

Detect and Alert

Operation

- The hazard warning lights will flash.
- The alarm will sound when the smart key is detected.

Automatic opening

Operation

- The tailgate will open.
- The hazard warning lights will flash.
- The alarm will sound 6 times.

Deactivating smart tailgate with smart key

Operation

- Press any of the following smart key buttons during "Detect and Alert" stage to deactivate the function.
 - Door lock button
 - Door unlock button
 - Tailgate open/close button

* NOTICE

- If you press the door unlock button, the Smart Tailgate with Auto Open function will be deactivated temporarily. But, if you do not open any door for 30 seconds, the Smart Tailgate with Auto Open function will be activated again.
- If you press the tailgate open button for more than 1 second, the tailgate opens.
- If you press the door lock button or tailgate open button when the Smart Tailgate with Auto Open function is not in the Detect and Alert stage, the Smart Tailgate with Auto Open function will not be deactivated.
- In case you have deactivated the Smart Tailgate with Auto Open function by pressing the smart key button and opened a door, the Smart Tailgate with Auto Open function can be activated again by closing and locking all doors.

Non-operating condition(s)

- The smart key is close to a radio transmitter such as a radio station or an airport, which can interfere with the normal operation of the smart key.
- The Smart Key is near a mobile two-way radio system or a cell phone.
- Another vehicle's smart key is being operated close to your vehicle.
- The detecting range may decrease or increase when:
 - One side of the vehicle is raised to replace a tire or to inspect the vehicle.
 - The vehicle is parked at a slant on a slope, an unpaved road, etc.

⚠ WARNING

- Make sure you close the tailgate before driving your vehicle.
- Make sure there are no people or objects around the tailgate before opening or closing the tailgate.
- Make sure objects in the tailgate do not come out when opening the tailgate on a slope. It may cause serious injury.
- Make sure to deactivate the Smart Tailgate with Auto Open when washing your vehicle. Otherwise, the tailgate may open inadvertently.
- The key should be kept out of reach of children. Children may inadvertently open the Smart Tailgate with Auto Open while playing around the rear area of the vehicle.

⚠ CAUTION

Do not approach the detecting area if you do not want the tailgate to open. If you have unintentionally entered the detecting area and the hazard warning lights and chime starts to operate, leave the detecting area with the smart key. The tailgate will stay closed.

* NOTICE

- If the power tailgate opening height is set manually, and then **User height setting** is selected from the infotainment system, the power tailgate will automatically open to the height manually set by the driver.
- If the power tailgate opening height has not been manually set, the power tailgate will fully open when **User height setting** from the infotainment system is selected.
- If one of the height (**Full open/Level 3/Level 2/Level 1**) is selected from the settings menu in the infotainment system screen, and then **User height setting** is selected, the power tailgate open height will be set to the previously saved height.

Tailgate emergency safety release

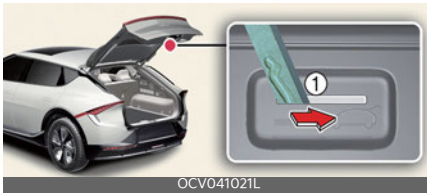

Operation

1. Insert the mechanical key into the keyhole.
2. Move the mechanical key to the right (1).
3. Push the tailgate upward.

⚠ WARNING

- For emergencies, be fully aware of the location of the emergency tailgate safety release lever in the vehicle and how to open the tailgate if you are accidentally locked in the luggage compartment.
- No one should be allowed to occupy the cargo area of the vehicle at any time. The cargo area is a very dangerous location in the event of a crash.
- Use the release lever for emergencies only. Use with extreme caution, especially while the vehicle is in motion.
- Do not grasp the part supporting the tailgate (gas lifter), as this may cause serious injury.



Windows

Left-hand drive

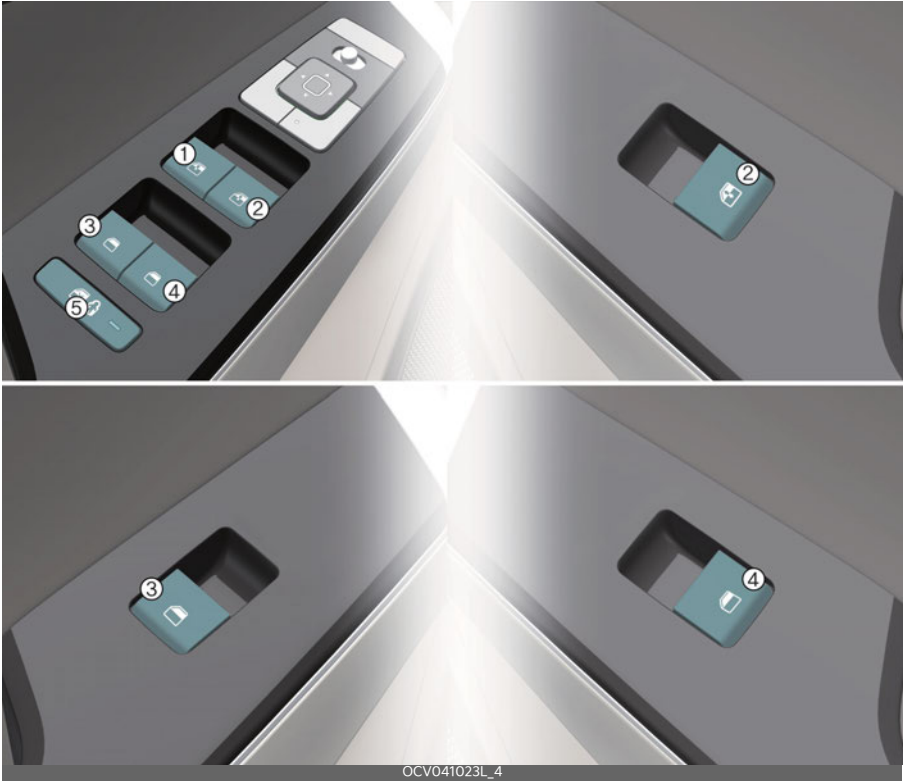

OCV041023L_4

Right-hand drive

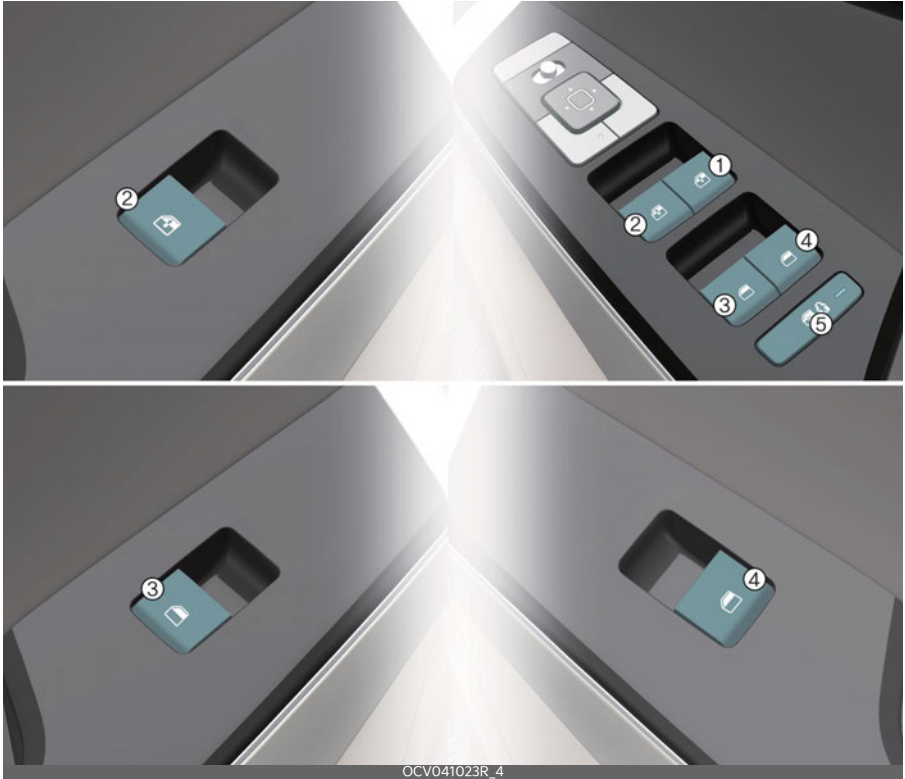

- 1 Driver's door power window switch
- 2 Front passenger's door power window switch
- 3 Rear door (left) window switch
- 4 Rear door (right) window switch
- 5 Power window lock switch

Controlling windows switch



- Type A: 1
- Type B (if equipped): 1, 2

Operation

- Press or pull the switch to the first (1)/ second (2) detent position.

* INFORMATION

Only type B can use auto up/down function (2).

Operating condition(s)

- The vehicle is in the ON position
- Within approximately 3 minutes after EV button turned to the ACC position. However, if the front doors are opened, the power windows cannot be operated even within the 3 minutes period.

Resetting the power windows

Operation

1. Close the window.
2. Pull the power window switch.
 - Approximately 1 second

Operating condition(s)

- The vehicle is in the ON position.

Power windows automatic reversal

Operation

- Windows will stop and move down approximately 30 cm (12 inches) when an object or body part is detected.
- Windows will move down approximately 2.5 cm (1 inches) when the force is detected.

Power windows lock button

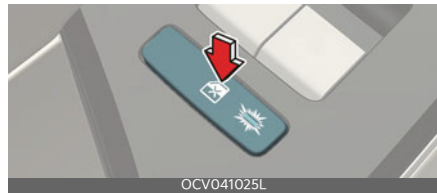

Operation

- Push the power windows lock button.
 - Rear passenger window is inoperable.
- The front driver and passenger window can be operated.
- The rear passengers' control cannot operate the rear passenger's power window.

Remote window closing/opening (if equipped)

Operation

- Press and hold the door lock button on the smart key to close the windows. The windows will move up as long as the button is pressed.
- Press and hold the door unlock button on the smart key to open the windows. The windows will move down as long as the button is pressed.
- Remote window operation can be activated or deactivated through the infotainment system menu.

WARNING

- Do not install any accessories in the area of windows. It may impact jam protection.
- Always check for obstructions before raising any window to avoid injuries or vehicle damage. If an object less than 4 mm (0.16 inches) in diameter is caught between the window glass and the upper window channel, the automatic reverse window may not detect the resistance and will not stop and reverse direction.
- The automatic reverse feature is not activated while resetting power window system. Make sure body parts or other objects are safely out of the way before closing the windows to avoid injuries or vehicle damage.
- NEVER leave the keys in your vehicle with unsupervised children, when the vehicle is running.

- NEVER leave any child unattended in the vehicle. Even very young children may inadvertently cause the vehicle to move, entangle themselves in the windows, or otherwise injure themselves or others.
- Always double check to make sure all arms, hands, head and other obstructions are safely out of the way before closing a window.
- Do not allow children play with the power windows. Keep the driver's door power window lock button in the LOCK position (pressed). SERIOUS INJURY can result from unintentional window operation by the child.
- Do not extend heads or any limbs outside the window while the vehicle is in motion.
- Make sure body parts of other objects are safely out of the way before remote closing the windows to avoid injuries or vehicle damage.

CAUTION

- To prevent possible damage to the power window system, do not open or close two windows or more at the same time. This will also ensure the longevity of the fuse.
- Never try to operate the main switch on the driver's door and the individual door window switch in opposite directions at the same time. If this is done, the window will stop and cannot be opened or closed.

* NOTICE

- While driving with the rear windows down or with the sunroof (if equipped) in an open (or partially open position), your vehicle may demonstrate a wind buffeting or pulsation noise. This noise is a normal occurrence and can be reduced or eliminated by taking the following actions. If the noise occurs with one or both of the rear windows down, partially lower both front windows approximately one inch. If you experience the noise with the sunroof open, slightly reduce the size of the sunroof opening.
- In cold and wet climates, power windows may not work properly due to freezing conditions.
- The automatic reverse feature for the window is only active when the "auto up" feature is used by fully pulling up the switch. The automatic reverse feature will not operate if the window is raised using the halfway position on the power window switch.

Hood

Opening/closing the hood



- 1 Hood release lever
- 2 Hood secondary latch

Operation

1. Pull the hood release lever (1).
2. Push the secondary latch (2) to the left.
3. Lift the hood upwards.
4. To close the hood, lower the hood and let it drop. Make sure that it is properly locked into place.



⚠ WARNING

- Open the hood after turning off the vehicle on a flat surface, shifting the gear to the P (Park) position and setting the parking brake.
- Before closing the hood, ensure that all obstructions are removed from the hood opening. Closing the hood with an obstruction present in the hood opening may result in property damage or severe personal injury.
- Do not leave gloves, rags or any other combustible material in the motor compartment. Doing so may cause a heat-induced fire.
- Always double check to be sure that the hood is firmly latched before driving away. If it is not latched, the hood could open while the vehicle is being driven, causing total loss of visibility, which might result in an accident.
- Do not move the vehicle with the hood raised. The view will be blocked and the hood could fall or be damaged.

Front trunk**Opening the front trunk****1 Front trunk lever**

1. Open the hood.
2. Lift up the front trunk cover while depressing the front trunk lever (1).

Closing the front trunk

Push down the front trunk cover.

*** INFORMATION**

Available front trunk weight

- 2WD: 25 kg (55 lbs.)
- 4WD: 10 kg (25 lbs.)

Available front trunk weight depends on the specifications.

⚠ WARNING

- NEVER make an attempt to get inside the front trunk. It will cause a fatal injury.
- Before closing the hood, ensure all obstructions are removed from around the hood opening. The hood will rise up or move down automatically if the height is not firmly adjusted. Be aware of the damage caused by the unintended hood movements.
- Never store cigarette lighters, propane cylinders, or other flammable/explosive materials in the vehicle. These items may catch fire and/or explode if the vehicle is exposed to

hot temperatures for extended periods.

⚠ CAUTION

- Do not exceed the luggage volume capacity of the front trunk. The overweighted front trunk can be severely damaged.
- Do not store the fragile objects in the front trunk.
- Always keep the front trunk cover closed securely while driving. Items inside your vehicle are moving as fast as the vehicle. If you have to stop or turn quickly, or if there is a crash, the items can be damaged.
- Do not spray water in the front trunk. Vehicle driving system may get damaged since the front trunk is located at the center of motor compartment.
- Be careful when you store any liquid in the front trunk. If liquid leak outside the front trunk, it will cause a damage to the electric devices in the motor compartment.
- Do not press the front trunk cover or place the objects on the front trunk cover. It may be deformed or damaged.
- When closing the front trunk cover, be careful not to touch objects inside the trunk. Loaded objects or the front trunk may be deformed or damaged and the front trunk cover may be opened during driving due to poor closing, resulting in joints and damage.

*** NOTICE**

To avoid possible theft, do not leave valuables in the storage compartments.

Charging door

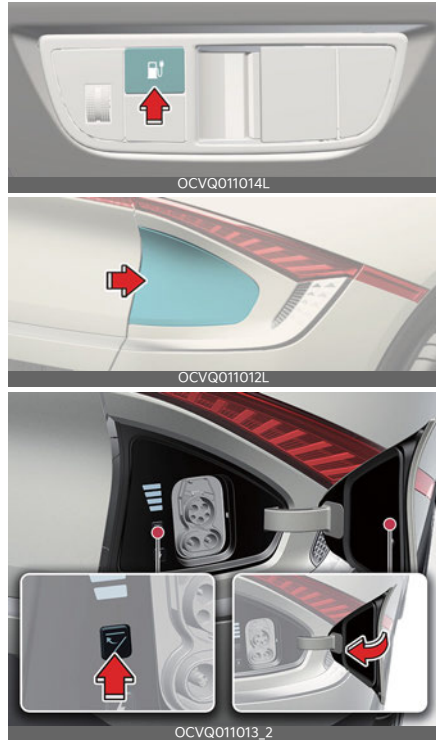

Opening/closing the charging door

Operation

- Push the charging door open/close button on the lower crashpad.
- Push the charging door close button located inner part of the charging door.

* INFORMATION

- The charging door automatically closes when:
 - The charging connector is disconnected
 - The door is opened and the charging connector is not connected for approximately 2 minutes
 - The gear is not in P (Park)
 - After replacing battery (12 volt), open and close the charging door once to check that the charging door automatic opening mechanism is functioning properly.
- * For more details, refer to "Electric charging door" on page 2-21.

▲ WARNING

Do not leave the vehicle with the charging door open. An open charging door may indicate that the vehicle door has been unlocked and may be subject to vehicle theft.

▲ CAUTION

- The charging door opens to the right. Check the surrounding while the charging door is open or close. Be aware of your head or limbs from being hit or stuck to the charging door.
- Do not hold the hinge to prevent damaging the charging door and causing other accidents.

* NOTICE

- If the charging door does not open because ice has formed around it, tap lightly or push on the door to break the ice and release the door. If necessary, use hand temperature to melt down the ice or move the vehicle to a warm place and allow the ice to melt. Do not pry on the charging door or use unauthorized tools to open the charging door.
- After closing the charging door, push the door again to ensure that the charging door is completely closed.
- Make sure that the charging door is closed before driving the vehicle. If the charging door is opened, mechanical parts of the charging door can be damaged.
- After closed the charging door, be sure to check the warning light is off.
- After charging the vehicle, close the charging inlet by the charging inlet cover properly. If the charging inlet cover is closed improperly, the charging inlet and the charging door can be damaged.
- Do not pry on the charging door while the charging door is opening. The charging door may stop moving. Also, the electrical mechanism of the charging door and its related parts can be severely damaged.
- While washing the vehicle, do not spray a high pressure water to the charging door directly. The high pressure can damage the charging door.

Wide sunroof (if equipped)

If your vehicle is equipped with a sunroof, you can slide or tilt your sunroof with the sunroof switch located on the overhead console.



The sunroof can only be operated when the EV button is in the ON or START position.

The sunroof can be operated for approximately 3 minutes after the EV button is in the ACC or OFF position. However, if the front door is open, the sunroof cannot be operated even within the 3 minutes period.

⚠ WARNING

- Never adjust the sunroof or sunshade while driving. This could result in loss of control and an accident that may cause injury, or property damage.
- Do not leave the vehicle running and the key in your vehicle with unsupervised children. Unattended children could operate the sunroof, which could result in serious injury.
- Do not sit on the top of the vehicle. It may cause injury or vehicle damage.

Power sunshade



Use the power sunshade to block direct sunlight coming through the sunroof glass.

- Push the sunroof switch rearward to the first detent position, the power sunshade automatically slides open.
- Push the sunroof switch forward to the first detent position, the power sunshade automatically closes. However, if the sunroof glass is open, the glass will close first.

To stop the power sunshade at any point, push the sunroof switch in any direction.

*** NOTICE**

Do not pull or push the power sunshade by hand as such action may damage the power sunshade or cause it to malfunction.

Wrinkles formed on the power sunshade are normal due to material characteristic.

Tilt open/close



- Push the sunroof switch upward, the sunroof glass tilts open. However, if the power sunshade is close, the sunshade will open first.
- Push the sunroof switch upward or forward when the sunroof glass is tilt opened, the sunroof glass automatically closes.

To stop the sunroof movement at any point, push the sunroof switch in any direction.

Slide open/close



- Push the sunroof switch rearward to the first detent position, the sunroof glass opens. However, if the power sunshade is close, the power sunshade will open first.

Push the sunroof switch forward to the first detent position, the sunroof glass closes. However, if the sunroof glass is close, the power sunshade will close.

- Push the sunroof switch forward or rearward to the second detent position, the sunroof glass and power sunshade operate automatically until full open or full close.

To stop the sunroof movement at any point, push the sunroof switch in any direction.

Automatic reversal



If the power sunshade or sunroof glass senses any obstacle while it is closing automatically, it will reverse direction then stop at a certain position.

The auto reverse function may not work if an object thin or soft is caught between the sliding power sunshade or sunroof glass and sunroof sash.

⚠ WARNING

- Make sure heads, hands, arms or any other body parts or objects are out of the way before operating the sunroof. Body parts or objects may get caught causing injuries or vehicle damage.
- Never deliberately use your body parts to test the automatic reversal function. The power sunshade or sunroof glass may reverse direction, but there is a risk of injury.

* NOTICE

- Do not continue to push the sunroof switch after the sunroof is fully opened, closed, or tilted. Damage to the sunroof motor could occur.
- Continuous operations such as slide open/close, tilt open/close, etc. may cause the motor or sunroof system to malfunction.
- Regularly remove any accumulated dust on the sunroof rail.
- Dust accumulated between the sunroof and roof panel can make noise. Open the sunroof and remove dust regularly using a clean cloth.
- Do not try to open the sunroof when the temperature is below freezing or when the sunroof is covered with snow or ice. The sunroof may not work properly and may break if opened by force.
- Do not open or drive with the sunroof glass open immediately after rain or washing the vehicle. Water may wet the interior of the vehicle.
- Do not extend any luggage outside the sunroof while driving. Vehicle damage may occur if the vehicle suddenly stops.

⚠ WARNING

Do not extend your head, arms, body parts or objects outside the sunroof while driving. Injuries may occur if the vehicle suddenly stops.

Resetting the sunroof



In some circumstances resetting the sunroof operation may need to be performed. Some instances where resetting the sunroof may be required include:

- When the 12-volt battery is either disconnected or discharged
- When the sunroof fuse is replaced
- If the sunroof one-touch AUTO OPEN/CLOSE operation is not functioning properly

Sunroof resetting procedure:

1. It is recommended to perform the reset procedure with the vehicle in the ready mode. Start the vehicle in P (Park).
2. Make sure the power sunshade and sunroof glass are in the fully closed position. If the power sunshade and sunroof glass are open, push the switch forward until the power sunshade and sunroof glass are fully closed.
3. Release the switch when the power sunshade and sunroof glass are fully closed.
4. Push the switch forward until the power sunshade and sunroof glass move slightly. Then release the switch.

- Once again push and hold the sunroof switch forward until the power sunshade and sunroof glass slide open and close. Do not release the switch until the operation is completed.

If you release the switch during operation, start the procedure again from step 2.

* NOTICE

If the sunroof does not reset when the vehicle battery is disconnected or discharged, or the sunroof fuse is blown, the sunroof may not operate normally.

Sunroof open warning

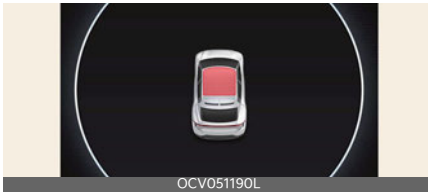

If the driver turns off the vehicle when the sunroof is not fully closed, the warning chime will sound for several seconds and the sunroof open warning will appear on the cluster LCD display. Close the sunroof securely when leaving your vehicle.

▲ CAUTION

Make sure the sunroof is closed fully when leaving your vehicle.

If the sunroof is left open, rain or snow may wet the interior of the vehicle. Also, leaving the sunroof open when the vehicle is unattended may invite theft.

Steering wheel

Adjusting the steering wheel angle and height



Operation

- Pull the lock-release lever (1) down.
- Adjust the steering wheel to the desired angle (2) and height (3).
- Pull the lock-release lever up.

Heated steering wheel (if equipped)



Operation

- Press the button to turn the heated steering wheel ON or OFF.
- The heated steering wheel reverts to the OFF position whenever the vehicle is restarted.

Operating condition(s)

- The vehicle should be in the ON position.

* INFORMATION

The heated steering wheel automatically controls the steering wheel temperature depending on the ambient temperature when the vehicle is running. For more details, refer to "Auto. controls that use climate control settings (if equipped)" on page 5-85.

Horn

Operating the horn



Operation

- Press the area around the horn symbol on your steering wheel.

⚠ WARNING

- Never adjust the angle and height of the steering wheel while driving. You may lose steering control and cause severe personal injury, death or accidents.
- After adjusting, push the steering wheel both up and down to be certain it is locked in position.
- If the steering wheel becomes too warm, turn the system off. The heated steering wheel may cause burns even at low temperatures, especially if used for long periods of time.

⚠ CAUTION

- Do not install any type of grip cover for the steering wheel, it may impair the function of the heated steering wheel system.
- When cleaning the heated steering wheel, do not use an organic solvent such as paint thinner, benzene, alcohol and gasoline. Doing so may damage the surface of the steering wheel.
- If the surface of the steering wheel is damaged by a sharp object, damage to the heated steering wheel components could occur.
- Do not strike the horn severely to operate it, or hit it with your fist. Do not press on the horn with a sharp-pointed object.
- When cleaning the steering wheel, do not use an organic solvent such as thinner, benzene, alcohol and gasoline. Doing so may damage the steering wheel.

* NOTICE

- Be sure to adjust the steering wheel to the desired position before driving.
- After adjustment, sometimes the lock-release lever may not lock the steering wheel. It is not a malfunction. This occurs when two gears engage. In this case, adjust the steering wheel again and then lock the steering wheel.

- The following symptoms may occur during normal vehicle operation:
 - The EPS warning light does not illuminate.
 - The steering effort is high immediately after pressing the EV button to ON position. This happens as the EPS system performs the diagnostics. When the diagnostics is completed, the steering effort will return to its normal condition.
 - A click noise may be heard from the EPS relay after EV button is in ON position.
 - Motor noise may be heard when the vehicle is at a stop or at a low driving speed.
 - When the abnormality is detected in the electric power steering system, a deadly accident prevention purposes, steering assist functions will be stopped. At this time, the instrument cluster warning light turns on or blinks and the power to manipulate the steering will be off. Please check immediately after moving the vehicle to a safe zone.
 - The steering effort increases if the steering wheel is rotated continuously when the vehicle is not in motion. However, after a few minutes, it will return to its normal conditions.
 - If the Electric Power Steering System does not operate normally, the warning light will illuminate or blink on the instrument cluster. The steering wheel may become difficult to control or operate abnormally. In this case, have the system inspected by a professional workshop. Kia recommends visiting an authorized Kia dealer/service partner.
 - When you operate the steering wheel in low temperature, abnormal noise could occur. If temperature rises, the noise will disappear. This is a normal condition.
 - When jump starting the vehicle after battery discharge, the steering wheel may not function properly. It is a temporary situation due to low battery voltage, and upon stable battery charging, the steering wheel will function normally again. Please move the steering wheel around to make sure the steering wheel is functioning properly before driving the vehicle.
 - The heated steering wheel will turn off automatically approximately 30 minutes after the heated steering wheel is turned on.
-

Mirrors

Interior rearview mirror

* Make the adjustment before you start driving.

Adjusting the day/night rearview mirror (if equipped)

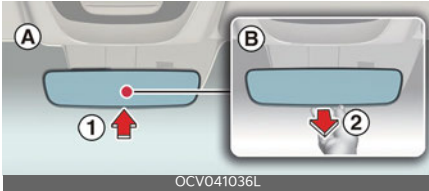

A: Day

B: Night

Operation

- Push the day/night lever (1) during daytime.
- Pull the day/night lever (2) to reduce headlamp glare during low light and nighttime driving conditions.

Electric Chromic Mirror (ECM) (if equipped)

The sensor detects the light level and automatically controls the headlamp glare during low light and nighttime driving conditions.

⚠ WARNING

- Do not place objects in the rear seat or cargo area which would interfere with your vision out the rear window.
- Do not adjust the rear view mirror while the vehicle is moving. This could result in loss of control, and an accident which could cause DEATH, SERIOUS INJURY, or property damage.
- Do not modify the inside mirror and don't install a wide mirror. It could result in injury, during an accident or deployment of the air bag.

Outside rear view mirror

Adjusting the outside rear view mirror



Operation

1. Move the outside rear view mirror switch (1) to select the left or right side of the mirror.
2. Adjust the mirror adjustment control (2) to move the selected mirror.

Folding the outside rear view mirror

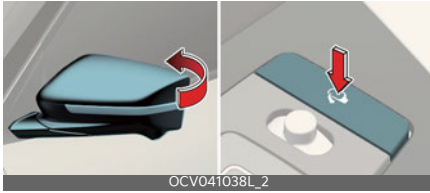

Operation

- Press the button to fold or unfold the mirror.

Auto reverse function (if equipped)



The outside rear view mirror will move downwards when the vehicle is in R (Reverse) position to assist reverse parking.

Operation

- The outside rear view mirror switch (1) position determines the mirror movement:
 - L/R: Outside rear view mirrors will move.
 - Center: Outside rear view mirrors will not move.

Auto Reverse function user setting

Operation

1. Shift to P (Park).
2. Move the switch to the L or R position depending on the mirror you want to adjust.
3. Shift to R (Reverse).
4. Adjust the mirror.

Initializing the Auto Reverse function

Operation

1. Shift to P (Park).
2. Move the switch to the L or R position depending on the mirror you want to adjust.
3. Shift to R (Reverse).
4. Adjust the mirror higher than the standard angle.
5. Shift to another gear position.

WARNING

- The outside rear view mirror is convex. Objects seen in the mirror are closer than they appear.
- Use your interior rear view mirror or direct observation to determine the actual distance of following vehicles when changing lanes.
- Do not adjust or fold the outside rear view mirrors while the vehicle is moving. This could result in loss of control, and an accident which could cause DEATH, SERIOUS INJURY, or property damage.

⚠ CAUTION

- Do not scrape ice off the mirror face; this may damage the surface of the glass. If ice should restrict the movement of the mirror, do not force the mirror for adjustment. To remove ice, use a deicer spray, or a sponge or soft cloth with warm water.
 - If the mirror is jammed with ice, do not adjust the mirror by force. Use an approved spray de-icer (not cooling system antifreeze) to release the frozen mechanism or move the vehicle to a warm place and allow the ice to melt.
 - The mirrors stop moving when they reach the maximum adjusting angles, but the motor continues to operate while the switch is pressed. Do not press the switch longer than necessary, the motor may be damaged.
 - Do not attempt to adjust the outside rear view mirror by hand. Doing so may damage the parts.
 - The electric type outside rear view mirror operates even though the vehicle is in the OFF position. However, to prevent unnecessary battery discharge, do not adjust the mirrors longer than necessary while the vehicle is not running.
 - In case it is an electric type outside rear view mirror, don't fold it by hand. It could cause motor failure.
 - We recommend following the procedures in an orderly manner to change or initialize the auto reversing user settings. If you move to the next step before completing the previous one, the changed angle may not be changed or initialization may not work properly.
-

Instrument cluster



1. Speedometer

- MPH, km/h
- The speed of the vehicle in kilometers per hour (km/h) or miles per hour (mph).

2. Distance to empty

- Estimated distance the vehicle can be driven with the remaining electric energy.

3. Power/Charge gauge

- The energy consumption rate of the vehicle and the charge/discharge status of the regenerative brakes.

4. Battery SOC (State of Charge) gauge

- Charging status of the high voltage battery.

5. LCD display

- Refer to "LCD display" on page 5-47.

6. Warning and indicator lights

- Refer to "Warning and indicator lights" on page 5-54.

7. Reduction gear shift indicator

- The indicator displays which gear is selected.

8. Odometer

- The odometer indicates the total distance that the vehicle has been driven.

9. Regenerative braking level indicator

- Refer to "Regenerative braking system" on page 6-15.

10. Electric energy economy

- Refer to "Trip computer mode" on page 5-48.

⚠ CAUTION

- The information is displayed after getting information from a weather information provider via GPS. Depending on conditions of GPS reception, the information may be different from the current weather in your area.
 - Be careful while driving as dynamic-themed animation effects can distract the driver and lead to unexpected accidents.
-

*** NOTICE**

- When the remaining battery is lower than 10% for the high voltage battery, the vehicle speed is limited and then eventually the vehicle will turn OFF. Charge the vehicle immediately.
 - If the vehicle is not on level ground or the battery power has been interrupted, the distance to empty function may not operate correctly.
 - The distance to empty may differ from the actual driving distance as it is an estimate of the available driving distance.
 - The distance to empty may vary significantly based on driving conditions, driving habits, and condition of the vehicle.
 - Use a clean soft microfiber cloth to gently wipe any finger prints off the touch screen.
 - The instrument cluster for the right-hand drive vehicle may be on the opposite side show differently.
-

LCD display

Changing LCD display modes



- 1 : MODE button for changing modes
- 2 : MOVE switch for changing items
- 3 : OK: SELECT/RESET button for setting or resetting the selected item

LCD display modes

		Mode				
		Driving Assist	Trip Computer	Turn By Turn (TBT)*	Information	Master Warning
^ v Up/ Down	Forward Collision-Avoidance Assist	Drive Information	Route Guidance	TPMS	The Master Warning mode displays warning messages related to the vehicle when one or more systems is not operating normally.	
	Lane Keeping Assist					
	Blind-Spot Collision-Avoidance Assist					
	Smart Cruise Control					
Lane Following Assist	Driver Attention Warning	After Recharging	Destination Info			
Highway Driving Assist	Speed Limit System	Accumulated Info				
		Energy Flow (4WD)				

Electric energy economy

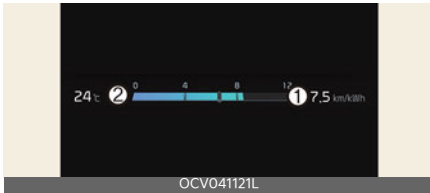

- 1 Average electric energy economy
- 2 Instant electric energy economy

Driving assist mode

This mode displays the state of:

- Forward Collision-Avoidance Assist
- Lane Keeping Assist
- Blind-Spot Collision-Avoidance Assist
- Smart Cruise Control
- Lane Following Assist
- Highway Driving Assist
- Driver Attention Warning
- Speed Limit System

Trip computer mode

* You may change through items in the following order.

Drive Info

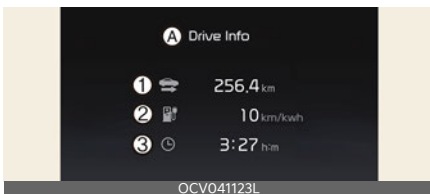

A: Drive Info

- 1 Accumulated trip distance
- 2 Average energy consumption
- 3 Total driving time

The driver's door is opened after turning off the vehicle or the vehicle is turned on after 3 minutes have passed, the Drive Info screen will reset.

After recharging



A: After recharging

- 1 Accumulated trip distance
- 2 Average energy consumption
- 3 Total driving time

The information after recharging.

To manually reset the information, press and hold the OK button when viewing the **After recharging**.

Accumulated Info



A: Accumulated Info

- 1 Accumulated trip distance
- 2 Average energy consumption
- 3 Total driving time

The information is accumulated starting from the last reset.

To manually reset the information, press and hold the OK button when viewing the **Accumulated Info**.

*** NOTICE**

- The vehicle must be driven for a minimum of 300 meters (0.19 miles) since the last cycle before the accumulated driving information is recalculated.
- The average electric energy economy is not displayed for more accurate calculation if the vehicle does not drive more than 10 seconds or 50 meters (0.03 miles) since the EV button is turned to ON.

Energy flow (4WD) (if equipped)



- The electric vehicle system informs the drivers its energy flow in various operating modes.
- The distribution status of the driving power of the front and rear wheels are displayed when Auto 4WD mode is activated. For more details, refer to "All wheel drive (4WD) (if equipped)" on page 6-34.

Turn By Turn (TBT) mode

This mode displays the Navigation status.

Information mode

Tire pressure



A: Low tire pressure

- Information related to Tire Pressure. Refer to "Tire Pressure Monitoring System (TPMS)" on page 7-5.

Master warning mode



This mode informs you of the following situations:

- Driver assistance system malfunction, limitation or radar/camera blockage
- LED headlamp malfunction
- Lamp malfunction
- TPMS failure, low tire pressure, etc.

At this time, a Master Warning icon (⚠) will appear in the lower right corner on the LCD display. If the warning situation is solved, the master warning light will be turned off and the Master Warning icon will disappear.

Service Interval

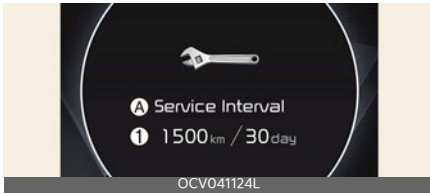

A: Service Interval

1 Service interval schedule

To reset the service interval, select **Settings** → **Vehicle** → **Cluster** → **Service Interval** → **Reset**.

* NOTICE

Calculates and displays when you need a scheduled maintenance service (mileage or days). If the remaining mileage or time reaches 1,500 km (900 miles) or 30 days, the message **Service in** is displayed for several seconds each time you set the vehicle to the ON position.

Driver assistance settings (infotainment system)







select **Settings** → **Vehicle** → **Driver assistance** on the infotainment system screen to set the Driver Assistance function.

- **Driver assistance**
 - **SCC (Smart Cruise Control)**
 - **Driving Convenience**
 - **Speed limit**
 - **Warning timing**
 - **Warning volume**
 - **Haptic warning**
 - **DAW (Driver Attention Warning)**
 - **Forward safety**
 - **Lane safety**
 - **Blind-spot safety**
 - **Parking safety**

LCD display messages

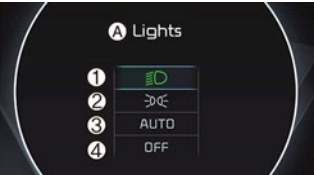
* For EV warning messages, refer to "LCD display messages" on page 2-41.

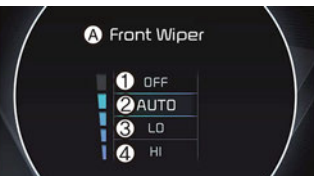
LCD displays	Displayed contents
	<p>Door, hood, tailgate, sunroof open</p>
	<p>Low tire pressure warning display A: Low tire pressure</p>
	<ul style="list-style-type: none"> • A: Lights • 1:  • 2:  • 3: AUTO • 4: OFF (O)
	<ul style="list-style-type: none"> • A: Front Wiper • 1: OFF (O) • 2: AUTO • 3: LO (1) • 4: HI (2)
<p>Low washer fluid</p>	<p>The washer fluid level in the reservoir is nearly empty</p>
<p>Icy road warning</p>	<p>The temperature on the outside temperature gauge is below approximately 4 °C (40 °F).</p>
<p>Low key battery</p>	<p>The battery in the smart key is flat</p>
<p>Press START button while turning wheel</p>	<p>The steering wheel does not unlock normally when the EV button is pressed</p>
<p>Steering wheel unlocked</p>	<p>The steering wheel does not lock when the EV button changes to the OFF position</p>
<p>Check steering wheel lock system</p>	<p>The steering wheel does not lock normally when the EV button changes to the OFF position</p>
<p>Check haptic steering wheel system</p>	<p>There is a problem with the haptic steering wheel system</p>
<p>Key not in vehicle</p>	<p>The smart key is not in the vehicle when you press the EV button</p>
<p>Key not detected</p>	<p>The smart key is not detected when you press the EV button</p>
<p>Press start button again</p>	<p>The EV button cannot be operated due to a problem with the EV button system</p>

LCD displays	Displayed contents
Press start button with key	The EV button is pressed while the "Key not detected" warning message is displayed
Check BCW system	Problem with Blind-spot Collision Warning (BCW)
Check BRAKE SWITCH fuse	The brake switch fuse is disconnected
Refill coolant	The coolant is low

*** INFORMATION**

- If there is no problem with the operation and the messages above are constantly displayed, have your vehicle inspected by a professional workshop. Kia recommends to contact an authorized Kia dealer/service partner.
- **Press start button again**
 - You could start the vehicle by pressing the EV button once more.
 - If the warning message is displayed each time you press the EV button, have the vehicle inspected by a professional workshop. Kia recommends visiting an authorized Kia dealer/service partner.
- **Check BRAKE SWITCH fuse**
 - You need to replace the fuse with a new one before starting the vehicle.
 - If that is not possible, you can start the vehicle by pressing the EV button for 10 seconds in the ACC position.

*** NOTICE**

- Some driving information stored in the trip computer resets if the battery is disconnected.
- If any of the following conditions occurs, the mileage and days may be incorrect.
 - The battery cable is disconnected.
 - The battery is discharged.
- If sunroof open warning is displayed in the cluster, the Driving Information message may not be displayed.
- To set the charging time and/or climate time, refer to Navigation Quick Reference Guide.
- If the icy road warning appears while driving, you should drive more attentively and safely refraining from over-speeding, rapid acceleration, sudden braking or sharp turning, etc.

Vehicle settings (infotainment system)



1. Press the **Settings** button on the head unit of the infotainment system.
2. Select **Vehicle** and change the setting of the features.

Vehicle Settings in the infotainment system provides user options for a variety of settings including door lock/unlock features, convenience features, driver assistance settings, etc.

- **Vehicle settings**
 - **Driver assistance**
 - **Drive mode**
 - **ECO Vehicle**
 - **Active sound design**
 - **Head-up display**
 - **Cluster**
 - **Climate**
 - **Seat**
 - **Lights**
 - **Door**
 - **Convenience**

⚠ WARNING

Do not operate the **Vehicle settings** while driving. This may cause distraction resulting in an accident.













*** NOTICE**















- The information provided may differ depending on which features are applicable to your vehicle.
- For detailed information, refer to Navigation Quick Reference Guide.

Warning and indicator lights

Once you set the vehicle to the ON position, the symbols shown below will light up. If these symbols remain on or malfunction, we recommend having the vehicle inspected by an authorized Kia dealer/service partner.

The information provided may differ according to which functions are applicable to your vehicle.

Symbol	Time	Notes
	3 seconds	Power down indicator light illuminates for approximately 3 seconds.
	Continuously	<ul style="list-style-type: none"> The high voltage battery level is too low or voltage is decreasing The temperature of the high voltage battery is too high or too low The temperature of the motor is high
	Continuously	Charging indicator light illuminates when charging the high voltage battery.
	Continuously	High voltage battery level warning light illuminates when the high voltage battery level is low. When the warning light turns ON, charge the battery immediately.
	3 seconds	Charging system warning light illuminates for approximately 3 seconds and then goes off.
	Continuously	<ul style="list-style-type: none"> Whenever there is a malfunction with either the LDC (Low DC-DC converter) or electrical charging system.
	Continuously	Seat belt warning light informs the driver that the seat belt is not fastened. Refer to "Seat belts" on page 4-12.
	6 seconds	The air bag warning light illuminates for about 6 seconds and then turns off.
	Continuously	<ul style="list-style-type: none"> There is a malfunction with the Safety Restraint System (SRS) air bag operation.
	3 seconds	Parking brake & brake fluid warning light illuminates for approximately 3 seconds.
	Continuously	<ul style="list-style-type: none"> Red: When the parking brake is applied. Red: When the brake fluid level in the reservoir is low. Red: When the regenerative brake does not operate. Yellow: Regenerative brake warning light illuminates when the regenerative brake does not operate and the brake does not perform well.
	3 seconds	The ABS warning light illuminates for about 3 seconds and then goes off.
	Continuously	<ul style="list-style-type: none"> Whenever there is a malfunction with the ABS.
	Continuously	Electronic Brake Force Distribution (EBD) system warning light illuminates when there is a problem with the Electronic Brake Force Distribution system.
	3 seconds	Electric Power Steering (EPS) warning light illuminates for about 3 seconds and then goes off.
	Continuously	<ul style="list-style-type: none"> Whenever there is a malfunction with the electric power steering.
	Continuously	Master warning light illuminates when there is a malfunction in various vehicle functions. To identify the details of the warning, refer to the LCD display warning message.
EPB	3 seconds	Electronic Parking Brake EPB warning light illuminates for about 3 seconds and then goes off.
	Continuously	<ul style="list-style-type: none"> Whenever there is a malfunction with the Electronic Parking Brake EPB
	3 seconds	Low tire pressure warning light illuminates for approximately 3 seconds and then goes off.
	Continuously	<ul style="list-style-type: none"> When one or more of your tires are significantly underinflated.
	Blinking	<ul style="list-style-type: none"> When there is a malfunction with the TPMS. Refer to "Tire Pressure Monitoring System (TPMS)" on page 7-5.
	3 seconds	Forward Safety warning light illuminates for approximately 3 seconds and then goes off.
	Continuously	<ul style="list-style-type: none"> Whenever there is a malfunction with Forward Collision-Avoidance Assist. Refer to "Forward Collision-Avoidance Assist (FCA) (if equipped)" on page 6-38.

Symbol	Time	Notes
	Continuously	Lane safety indicator light illuminates: <ul style="list-style-type: none"> Green: When Lane Keeping Assist operating conditions are satisfied. White: When Lane Keeping Assist operating conditions are not satisfied. Yellow: Whenever there is a malfunction with Lane Keeping Assist. Refer to "Lane Keeping Assist (LKA) (if equipped)" on page 6-57.
	Continuously	Lane Following Assist indicator light illuminates: <ul style="list-style-type: none"> Green: When Lane Following Assist is activated Gray: When Lane Following Assist operating conditions are not satisfied Yellow: Whenever there is a malfunction with Lane Following Assist Refer to "Lane Following Assist (LFA)" on page 6-117.
	Continuously	Highway Lane Change Assist indicator light illuminates: <ul style="list-style-type: none"> Green: When Highway Lane Change Assist is ready for operation. Grey: When Highway Lane Change Assist is in standby. Refer to "Highway Driving Assist (HDA) (if equipped)" on page 6-120.
	Blinking	<ul style="list-style-type: none"> Green: When Highway Lane Change Assist is operating. White: When Highway Lane Change Assist is canceled. Refer to "Highway Driving Assist (HDA) (if equipped)" on page 6-120.
	Continuously	Whenever there is a malfunction with the 4WD system. Refer to "All wheel drive (4WD) (if equipped)" on page 6-34.
	3 seconds	LED headlight warning light illuminates for approximately 3 seconds and then goes off.
	Continuously	<ul style="list-style-type: none"> Whenever there is a malfunction with the LED headlight.
	Blinking	<ul style="list-style-type: none"> Whenever there is a malfunction with a LED headlight related part.
	Continuously	Icy road warning light and outside temperature gauge blinks and then illuminates. Also, the warning chime sounds 1 time.
	3 seconds	Electronic Stability Control indicator light illuminates for about 3 seconds and then goes off.
	Continuously	<ul style="list-style-type: none"> Whenever there is a malfunction with ESC system.
	3 seconds	The ESC OFF indicator light illuminates for approximately 3 seconds and then goes off.
	Continuously	<ul style="list-style-type: none"> When you deactivate ESC system by pressing the ESC OFF button. Refer to "Electronic Stability Control (ESC)" on page 6-28.
	Continuously	When the vehicle detects the smart key in the vehicle in ACC/ON position
	Blinking	When the key is not in the vehicle Whenever there is a malfunction with the immobilizer system.
	2 seconds	When the vehicle cannot detect the smart key.
	Blinks	When the turn signal light is on
	Continuously	When high-beam headlamps are on.
	Continuously	When low-beam headlamps are on.
	Continuously	When the light switch is in the ON position
	Continuously	When the rear fog lights are on.
	Continuously	When HBA is activated.
AUTO HOLD	Continuously	When AUTO HOLD is activated.
READY	Continuously	Ready indicator illuminates when the vehicle is ready to be driven.
	Off	<ul style="list-style-type: none"> Normal driving is not possible, or a problem has occurred.
	Blinking	<ul style="list-style-type: none"> Emergency driving, there is a problem with the system.

Symbol	Time	Notes
	6 seconds	Service warning light illuminates for approximately 3 seconds and then goes off.
	Continuously	<ul style="list-style-type: none"> When there is a problem with related parts of the electric vehicle control system, such as sensors, etc.
AFS	3 seconds	Intelligent Front-Lighting System warning light illuminates for approximately 3 seconds and then goes off.
	Continuously	<ul style="list-style-type: none"> Whenever there is a malfunction with Intelligent Front-Lighting System. Refer to "Intelligent front-lighting system (IFS) (if equipped)" on page 5-66.
SOS	3 seconds	SOS warning light illuminates for approximately 3 seconds and then goes off.
	Continuously	<ul style="list-style-type: none"> Whenever there is a malfunction with the eCall system. Refer to "Pan-European eCall System" on page 7-19.
ECO SPORT SNOW	Continuously	When you select each mode as drive mode. Refer to "Drive mode integrated control system" on page 6-32.

*** INFORMATION**

• Dual-diagonal braking system

Your vehicle is equipped with dual diagonal braking systems. This means you still have braking on two wheels even if one of the dual systems should fail.

With only one of the dual systems working, more than normal pedal travel and greater pedal pressure are required to stop the vehicle. Also, the vehicle will not stop in as short a distance with only a portion of the brake system working.



• Ready Indicator READY

When the ready indicator goes OFF or blinks, there is a problem with the system. In this case, Kia recommend that you have your vehicle inspected by an authorized Kia dealer/service partner.

⚠ WARNING

• Parking brake & brake fluid warning light 

- Driving the vehicle with a warning light ON is dangerous. If the parking brake & brake fluid warning light illuminates with the parking brake released, it indicates that the brake fluid level is low.
- In this case, have the vehicle inspected by a professional workshop. Kia recommends visiting an authorized Kia dealer/service partner.

• Electronic Brake force Distribution (EBD) system warning light  

- When both ABS and parking brake & brake fluid warning lights are on, the brake system will not work normally and you may experience an unexpected and dangerous situation during sudden braking.
- In this case, avoid high speed driving and abrupt braking. We recommend you have the vehicle inspected by an authorized Kia dealer/service partner as soon as possible.

- **Safe stopping**

- The TPMS cannot alert you to severe and sudden tire damage caused by external factors.
- If you notice any vehicle instability, immediately take your foot off the accelerator pedal, apply the brakes gradually with light force, and slowly move to a safe position off the road.



*** NOTICE**

- Make sure that all warning lights are OFF after starting the vehicle. If any light is still ON, this indicates a situation that needs attention.

- **Power down indicator light** 

- Do not accelerate or start the vehicle suddenly when the power down indicator light is ON.

When the power is limited for the safety of the high-powered parts of an electric vehicle, the power down indicator light illuminates. Your vehicle may not be driven, or may roll back on a slope with the indicator light ON.

- **Electronic Brake force Distribution (EBD) system warning light**  

- When the ABS warning light is on or both ABS and Parking Brake & Brake Fluid warning lights are on, the speedometer, odometer, or trip-meter may not work. Also, the EPS warning light may illuminate and the steering effort may increase or decrease.

- In this case, avoid high speed driving and abrupt braking. We recommend you have the vehicle inspected by an authorized Kia dealer/service partner as soon as possible.

- The Electronic Parking Brake **EPB** warning light may illuminate when the Electronic Stability Control (ESC) indicator light comes on to indicate that the ESC is not working properly (This does not indicate malfunction of the EPB).

- Continuous driving with the LED Headlight warning light on or blinking can reduce LED headlight life.
 - If the icy road warning light appears while driving, you should drive more attentively and safely refraining from over-speeding, rapid acceleration, sudden braking or sharp turning, etc.
-

Augmented Reality HUD (if equipped)



The Head-Up Display projects the instrument cluster and navigation information onto the windshield.

Head-up display settings



A: **Head-up display**

- 1 **Display mode**
- 2 **Augmented reality mode**
- 3 **Standard mode**
- 4 **Head-up display off**

Head-up display can be enabled from the Settings menu in the infotainment system screen. Select either **Augmented reality mode** or **Standard mode** from:

- **Settings** → **Vehicle** → **Head-up display** → **Display mode** → **Augmented reality mode/Standard mode**

After turning on the head-up display, you can change the settings of **Display control**, **Augmented reality calibration** and **Content selection** of the Head-Up Display.

Head-up display information

AR mode display information



- 1 Turn By Turn (TBT) navigation information
- 2 Traffic information
- 3 Speedometer information
- 4 SCC set speed information
- 5 SCC vehicle distance information
- 6 Lane Following Assist information
- 7 Lane Safety information
- 8 Blind-Spot Safety information
- 9 Highway Auto Speed Change information
- 10 Highway Driving Assist information
- 11 Turn by turn (TBT) navigation information (AR)
- 12 Lane Safety information (AR)
- 13 Front Vehicle indicator (AR) (if Highway Lane Change Assist function equipped)
- 14 Leading Vehicle Departure Alert (AR)
- 15 Highway Lane Change Assist information (AR)

Standard mode display information



- 1 Turn By Turn (TBT) navigation information
- 2 Traffic information
- 3 Speedometer information
- 4 SCC set speed information
- 5 SCC vehicle distance information
- 6 Lane Following Assist information
- 7 Lane Safety information
- 8 Blind-Spot Safety information
- 9 Highway Auto Speed Change information
- 10 Highway Driving Assist information
- 11 Surrounding vehicle information

Precautions while using the head-up display

- It may sometimes be difficult to read information on the Head-Up Display in the following situations.
 - The driver is improperly positioned in the driver's seat
 - The driver wears polarizing-filter sunglasses
 - An object is located above the head-up display cover
 - The vehicle is driven on a wet road
 - Any improper lighting accessory is installed inside the vehicle, or there is incoming light from outside of the vehicle
 - The driver wears glasses
 - The driver wears contact lenses
- When it is difficult to read the Head-Up Display information, adjust the image position, brightness level or AR matching information from the Settings menu in the infotainment system screen.
- The AR mode display information may be difficult to recognize when the vehicle is driven under severe weather condition, such as heavy rain, heavy snow, low visibility, etc.
- Head-up display information may partially overlap the road ahead, causing fatigue and discomfort while driving. Adjust the image if you feel tired or uncomfortable, or if symptoms persist, turn off the head-up display.
- When the direct flash light or sunlight hits the front windshield, a warning message will appear. If the temperature of the front windshield keep rises, Head-up display will be deactivated temporarily to protect Head-up display from the high temperature. When the temperature drops, Head-up display will be reactivated.
- For your safety, make sure to stop the vehicle before adjusting the settings.
- Do not tint the front windshield glass or add other types of metallic coating. Otherwise, the Head-Up Display image may be invisible.
- Do not place any accessories on the crash pad or attach any objects on the windshield glass.
- When replacing the front windshield glass, replace it with a windshield glass designed for Head-Up Display operation. Otherwise, duplicated images may be displayed on the windshield glass.

⚠ WARNING

- The warning information of Blind-Spot Safety on the Head-Up Display are supplemental. Do not solely depend on them to change lanes. Always take a look around before changing lanes.

The driving route guidance display in the augmented reality mode is an auxiliary function. Be sure to check the navigation screen together.

- ALWAYS pay attention on the road while driving when the Head-Up Display is on.

*** NOTICE**

- AR mode is the basic setting for Head-up display.
For detailed information, refer to Navigation Quick Reference Guide.
- Standard Head-up display information may not be consistent based on the different system settings menu.

*** NOTICE**

To obtain the source code developed under the open source license installed on this product, please visit <http://www.mobis.co.kr/opensource/list.do>.

You can download all applicable license notices, including the source code.

If you send an e-mail to MOBIS_OSSrequest@mobis.co.kr within three (3) years of your purchase of the product to request an open source code for the software on this product, you will receive it in a CD-ROM and/or other storage medium at a minimal charge (the charge will cover costs for the storage medium and delivery).

Lighting**Battery saver function****Operation**

- The position lamp will turn off automatically.

Operating condition(s)

- The vehicle is off and the driver's door is opened.

*** INFORMATION**

- However, the position lamps stay ON even when the driver side door is opened if the light switch is operated after the vehicle is turned off.
- If necessary, to keep the lamps on turn the position lamps OFF and ON again using the headlamp switch on the steering column after the engine is turned off.

⚠ CAUTION

To prevent the battery from being discharged, do not leave the headlight and interior light on for a prolonged time while the vehicle is not running.

Headlamp escort function

Operation

- The headlamps remain on for approximately 5 minutes if the vehicle is in ACC or OFF position with the headlamps ON.
- The headlamps turn off after 15 seconds if The driver door is opened and closed.
- To turn the headlamps OFF:
 - Press the lock button on the key twice
 - Turn the headlamp switch to OFF position

Operating condition(s)

- The vehicle is in ACC or OFF position with the headlamps ON
- The driver's door is opened and closed

Daytime Running Light (DRL)

Operating condition(s)

- The vehicle is in the ON position
- The headlamp switch is in the OFF position
- The parking brake is disengaged

Traffic change (For Europe)

The distribution of light from low-beam headlamps is asymmetrical. If you go to a country with opposite traffic direction, this asymmetrical distribution will dazzle drivers in oncoming vehicles. To avoid dazzling other drivers, ECE regulations require various technical solutions (e.g., automatic change system, adhesive sheet, downward aim). This vehicle's headlamps are designed not to dazzle oncoming drivers. Thus, you need not change your headlamps when in a country with opposite traffic direction.

Lighting controls

Operating lights

Type A



Type B



Type C



Operation

1 OFF (O)

2 AUTO

- The headlamps and tailamps will turn ON or OFF automatically depending on the external ambient light level.

3 Position & Taillamp (☞)

4 Low beam (☞)

* INFORMATION

The vehicle must be in the ON position to turn on the headlights.

⚠ CAUTION

- Never place anything over the sensor located on the instrument cluster as this will ensure better auto-light system control.
- Don't clean the sensor using a window cleaner, the cleaner may leave a light film which could interfere with sensor operation.
- If your vehicle has window tint or other types of metallic coating on the front windshield, the Auto light system may not work properly.

Operating the turn signals



Operation

- Move the lever up or down (A).

* NOTICE

If an indicator flash is abnormally quick or slow, a bulb may be burned out or have a poor electrical connection in the circuit.

One-Touch Lane-Change function

Operation

- Move the turn signal lever up or down (B).
- Release the lever.

*** INFORMATION**

- You can activate or deactivate the One Touch Turn Signal function or choose the number of blinking (3, 5, or 7) by selecting **Settings** → **Vehicle** → **Lights** → **One-touch turn indicator**.
- If an indicator stays on and does not flash or if it flashes abnormally, one of the turn signal bulbs may be burned out and will require replacement.

Operating the fog lights



Operation

- Turn the fog light switch (1) to the dedicated position.
- Rear: (R)

Operating condition(s)

- The headlamps are turned ON.

⚠ CAUTION

When in operation, the fog lights consume large amounts of vehicle electrical power. Only use the fog lights when visibility is poor.

Operating the high-beam headlamps



Operation

- Push the lever to use high beam.
- Pull the lever towards you to flash the headlights (H).

⚠ WARNING

Do not use high beam when there are other vehicles. Using high beam could obstruct the other driver's vision.

High Beam Assist (HBA) (if equipped)



High Beam Assist is a function that automatically adjusts the headlamp range (switches between high beam and low beam) depending on the brightness of detected vehicles and certain road conditions.

Detecting sensor

Front view camera



The front view camera is used as a detecting sensor to detect ambient light and brightness while driving. Refer to the picture above for the detailed location of the detecting sensor.

CAUTION

Always keep the front view camera in good condition to maintain optimal performance of High Beam Assist.

For more details on the precautions of the front view camera, refer to "Forward Collision-Avoidance Assist (FCA) (if equipped)" on page 6-38.

High Beam Assist Setting

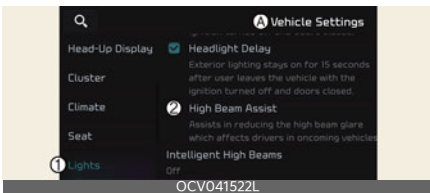

A: Vehicle Settings

1 Lights

2 HBA (High Beam Assist)

With the vehicle in the ON position, select **Settings** → **Vehicle** → **Lights** → **HBA (High Beam Assist)** from the Settings menu to turn on High Beam Assist function.

WARNING

For your safety, change the Settings after parking the vehicle at a safe location.

High Beam Assist operation

- After selecting **HBA (High Beam Assist)** in the **Settings** menu, High Beam Assist will operate by following the procedure below.
 - Place the headlamp switch in the AUTO position and push the headlamp lever towards the instrument cluster. The High Beam Assist (HBA) indicator light will illuminate on the cluster and the function will be enabled.
 - When the function is enabled, high beam will turn on when vehicle speed is above 40 km/h (25 mph). When vehicle speed is below 25 km/h (15 mph), high beam will not turn on. The High Beam (HB) indicator light will illuminate on the cluster when high beam is on.
- When High Beam Assist is operating, if the headlamp lever or switch is used, the function operates as follows:
 - If the headlamp lever is pulled towards you when the high beam is off, the high beam will turn on. When you let go of the headlamp lever, High Beam Assist will turn on again.
 - If the headlamp lever is pulled towards you when the high beam is on, the low beam will turn on and High Beam Assist will be canceled.
 - If you push the light switch towards the instrument cluster, high beam is turned on and High Beam Assist is released.

- If the headlamp switch is placed from AUTO to another position (headlamp/position/off), High Beam Assist will turn off and the corresponding lamp will turn on.
- When High Beam Assist is operating, high beam switches to low beam if any of the following conditions occur:
 - When the headlamp of an oncoming vehicle is detected.
 - When the tail lamp of a vehicle in front is detected.
 - When the headlamp or tail lamp of a motorcycle or a bicycle is detected.
 - When the surrounding ambient light is bright enough that high beams are not required.
 - When streetlights or other lights are detected.

*** NOTICE**

- Depending on the instrument cluster specifications or theme, images or colors may be displayed differently.

High Beam Assist Malfunction and limitations

High Beam Assist Malfunction

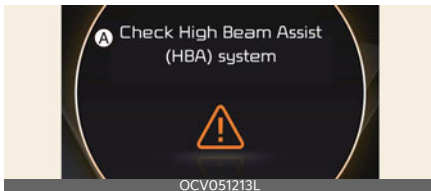

A: Check High Beam Assist (HBA) system

When High Beam Assist is not working properly, the warning message will appear and warning light (⚠) will illuminate on the cluster. We recommend that

you have your vehicle inspected by an authorized Kia dealer/service partner.

Limitations of High Beam Assist

- Light from a vehicle is not detected because of lamp damage, or because it is hidden from sight, etc.
- Headlamp of a vehicle is covered with dust, snow or water.
- A vehicle's headlamps are off but the fog lamps are on and etc.
- There is a lamp that has a similar shape as a vehicle's lamp.
- Headlamps have been damaged or not repaired properly.
- Headlamps are not aimed properly.
- Driving on a narrow curved road, rough road, uphill or downhill.
- Vehicle in front is partially visible on a crossroad or curved road.
- There is a traffic light, reflecting sign, flashing sign or mirror ahead.
- There is a temporary reflector or flash ahead (construction area).
- The road conditions are bad such as being wet, iced or covered with snow.
- A vehicle suddenly appears from a curve.
- The vehicle is tilted from a flat tire or is being towed.
- Light from a vehicle is not detected because of exhaust fume, smoke, fog, snow, etc.

*** NOTICE**

For more details on the limitations of the front view camera, refer to "Forward Collision-Avoidance Assist (FCA) (if equipped)" on page 6-38.

WARNING

- At times, High Beam Assist may not work properly. The function is for your convenience only. It is the responsibility of the driver for safe driving practices and always check the road conditions for your safety.
- When High Beam Assist does not operate normally, change the headlamp position manually between high beam and low beam.

Intelligent front-lighting system (IFS) (if equipped)

Intelligent Front-Lighting System secures a clear view for the driver with the high beam on while driving at night.

System setting



A: Lights

- 1 Intelligent front-lighting**
- 2 Faster Than 60 km/h**
- 3 Faster Than 40 km/h**
- 4 Faster Than 20 km/h**
- 5 Off**

With the vehicle in the ON position, select **Settings** → **Vehicle** → **Lights** → **Intelligent front-lighting** in the Settings menu to turn on Intelligent Front-Lighting System and deselect to turn off the system.

WARNING

For your safety, change the Settings after parking the vehicle at a safe location.

System operation

Display and control



Intelligent Front-Lighting System will operate by following the procedure below.

- Place the headlamp switch in the AUTO position and push the headlamp lever toward the instrument cluster. The Intelligent Front-Lighting System (IFS) indicator will illuminate on the cluster and the system will be enabled.
- When the system is enabled, the Intelligent Front-Lighting System will operate according to the set speed in the infotainment system. The initial system is set to work when vehicle speed is above 40 km/h (25 mph).
- The high beam LED partially turns off if an oncoming vehicle or a vehicle ahead is detected by the front view camera.
- If Intelligent Front-Lighting System detects an oncoming vehicle or a vehicle ahead while driving at high speed (approximately above 100 km/h (60 mph), the driver's side headlamp will turn off and only the passen-

ger's side headlamp will be controlled by the system.

System malfunction and limitations

System malfunction



A: Check Intelligent Front-Lighting System (IFS)

When Intelligent Front-Lighting System is not working properly, the warning message will come on for a few second on the cluster. After the message disappears, the warning lights **AFS** will illuminate. We recommend that you have your vehicle inspected by an authorized Kia dealer/service partner.

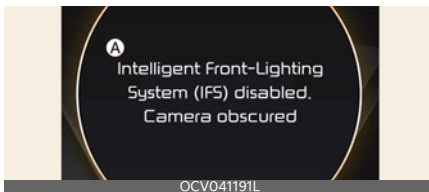

A: Intelligent Front-Lighting System (IFS) disabled. Camera obscured

When the front view camera is covered with dirt, snow, or debris, Intelligent Front-Lighting System may temporarily not work properly. If this occurs, a warning message will appear on the cluster. The system will operate normally when such dirt, snow or debris is removed. Intelligent Front-Lighting System may not properly operate in an area (e.g. open terrain) where any objects or vehi-

cles are not detected after turning on the vehicle.

Also, even though a warning message does not appear on the cluster, the system may not properly operate.

Limitations of the system

Intelligent Front-Lighting System may not work properly in the following situations.

- Light from a vehicle is not detected because of lamp damage, or because it is hidden from sight, etc.
- Headlamp of a vehicle is covered with dust, snow or water.
- There is a lamp that has a similar shape as a vehicle's lamp.
- A vehicle's headlamps are off but the fog lamps are on and etc.
- Headlamps have been damaged or not repaired properly.
- Headlamps are not aimed properly.
- Driving on a narrow curved road, rough road, uphill or downhill.
- Vehicle in front is partially visible on a crossroad or curved road.
- There is a traffic light, reflecting sign, flashing sign or mirror ahead.
- There is a temporary reflector or flash ahead (construction area).
- The road conditions are bad such as being wet, iced or covered with snow.
- A vehicle suddenly appears from a curve.
- The vehicle is tilted from a flat tire or is being towed.
- There are many street lights or the ambient light is bright.
- Light from a vehicle is not detected because of exhaust fume, smoke, fog, snow, etc.

- The front windshield is covered with foreign substance.

Headlamp leveling adjustment (if equipped)



Operation

- The higher the number of the switch position is, the lower the headlight beam level.
- Always keep the headlamp beam at the proper leveling position, or your headlamps may dazzle other road users.

Loading condition	Switch position
Driver only	0
Driver + Front passenger	0
Full set of passengers (including driver)	1
Full set of passengers (including driver) + Maximum permissible loading	2
Driver + Maximum permissible loading	3

Wipers and washers

Wipers

Controlling the wipers

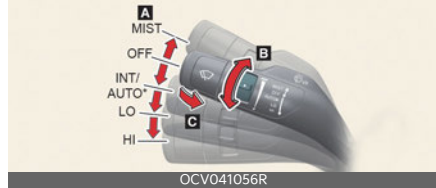
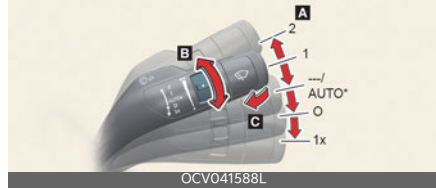
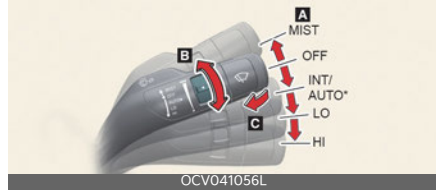

Operation

- A: Front wiper speed control
 - MIST (1x): Single wipe
 - OFF (0): Off
 - INT (---): Intermittent control wipe
 - AUTO*: Auto control wipe
 - LO (1): Low wiper speed
 - HI (2): High wiper speed
- B: Intermittent control wipe time adjustment/Auto control wipe time adjustment*
- C: Wash with brief wipes

Controlling the wipers automatically

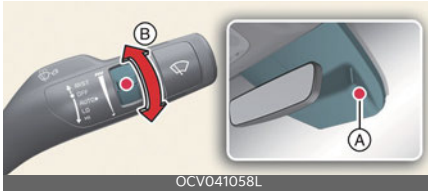

A: Rain sensor

B: Wiper speed control switch

Operation

- The rain sensor (A) senses the amount of rainfall and adjusts the wiper speed interval accordingly.
- Turn the speed control switch (B) to adjust the wiper speed.

Washers

Controlling the washers



Operation

1. Move the wiper speed control switch to OFF (O) position.
2. Pull the lever gently toward you to spray washer fluid on the windshield.
3. Operate the wipers so they perform several cycles.

⚠ WARNING

Do not use the washer in freezing temperatures without first warming the windshield with the defrosters; the washer solution could freeze on the windshield and obscure your vision.

⚠ CAUTION

- When the EV button is in ON position and the windshield wiper switch is placed in the AUTO mode, use caution in the following situations to avoid any injury to the hands or other parts of the body:

- Do not touch the upper end of the windshield glass facing the rain sensor.
- Do not wipe the upper end of the windshield glass with a damp or wet cloth.
- Do not put pressure on the windshield glass.

- When washing the vehicle, set the wiper switch in the OFF (O) position to stop the auto wiper operation.

The wiper may operate and be damaged if the switch is set in the AUTO mode while washing the vehicle.

- Do not remove the sensor cover located on the upper end of the driver or passenger side windshield glass. Damage to system parts could occur and may not be covered by your vehicle warranty.

- When starting the vehicle in winter, set the wiper switch in the OFF (O) position. Otherwise, wipers may operate and ice may damage the windshield wiper blades. Always remove all snow and ice and defrost the windshield properly prior to operating the windshield wipers.

- When tinting the windshield, be careful of any fluid getting into the sensor located in the top center of the front windshield. It may damage the related parts.

- To prevent possible damage to the washer pump, do not operate the washer when the fluid reservoir is empty.
- To prevent possible damage to the wipers or windshield, do not operate the wipers when the windshield is dry.
- To prevent damage to the wiper blades, do not use gasoline, kerosene, paint thinner, or other solvents on or near them.
- To prevent damage to the wiper arms and other components, do not attempt to move the wipers manually.
- To prevent possible damage to the wipers and washer system, use anti-freezing washer fluids in the winter season or cold weather.

*** NOTICE**

If there is heavy accumulation of snow or ice on the windshield, defrost the windshield for about 10 minutes, or until the snow and/or ice is removed before using the windshield wipers to ensure proper operation. If you do not remove the snow and/or ice before using the wiper and washer, it may damage the wiper and washer system.

Welcome system

The surroundings or the interior will be lit up when the driver approaches or exits the vehicle.

Body silhouette lamp



Operation

- Body silhouette lamp will turn on for approximately 15 seconds.

Operating condition(s)

- All the doors (and tailgate) are closed and locked.

Headlamp escort function

Operation

- The headlamps remain on for approximately 5 minutes if the vehicle is in ACC or OFF position with the headlamps ON.
- The headlamps turn off after 15 seconds if the driver door is opened and closed.

Operating condition(s)

- Vehicle is in the ACC position.
- The driver door is opened and closed.

Interior lighting

Operation

- The room lamp will turn on.
 - For approximately 30 seconds.

Operating condition(s)

- The map lamp switch is in DOOR mode.
- All the doors (and tailgate) are closed and locked.

Interior lights

Automatic turn-off function

Operation

- The interior lights will turn off.
 - After approximately 20 minutes.



Operating condition(s)

- The vehicle is in the OFF position.
- The lights are in the ON position.

Map lamp



Operation

- Press the lamp (1) to turn the map lamp ON.
-  (2): DOOR mode
-  (3): Front and rear room lamps on and off.

* INFORMATION

- The map lamp and room lamp come on approximately 30 seconds.
 - When a door is opened.
 - When doors are unlocked with a smart key as long as the doors are not opened.
- The map lamp and room lamp will stay on
 - If a door is opened with the vehicle in the ACC or OFF position. (5 minutes)

- If the door is opened with the vehicle in the ON position. (continuously)
- The map lamp and room lamp will go out
 - If the vehicle is changed to the ON position or all doors are locked. (immediately)

Room lamp



Operation

- Press the switch to turn the room lamp on or off.

Luggage space lamp



Operation

- Open the tailgate. The lamp will turn on.

Vanity mirror lamp



Operation

- ☞: The lamp will turn on if this button is pressed.
- ○: The lamp will turn off if this button is pressed again.

Glove box lamp



Operation

- The glove box lamp comes on when the glove box is opened.

⚠ WARNING

Do not use the interior lights when driving in the dark. Accidents could happen because the view may be obscured by interior lights.

⚠ CAUTION

Do not use the interior lights for extended periods when the vehicle is not running. It may cause battery discharge.

*** NOTICE**

- The DOOR mode and ROOM mode can not be selected at a time.
- To prevent unnecessary charging system drain, close the vanity mirror cover after using the mirror.
- To prevent unnecessary charging system drain, close the glove box securely after using the glove box.

Climate control system

Climate control system components

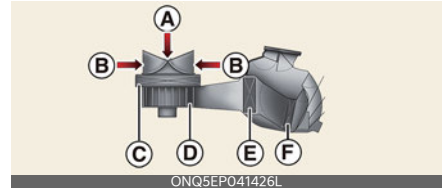

A: Outside air

B: Recirculated air

C: Climate control air filter

D: Blower

E: Evaporator core

F: Heater core

The climate control air filter installed behind the front trunk filters the dust or other pollutants that come into the vehicle from the outside through the heating and air conditioning system.

If dust or other pollutants accumulate in the filter over a period of time, the air flow from the air vents may decrease. This leads to moisture accumulating on the inside of the windshield even when the outside (fresh) air position is selected.

If this happens, have the climate control air filter replaced by a professional workshop. Kia recommends visiting an authorized Kia dealer/service partner.

Air conditioning refrigerant label

Example Type A



Example Type B



- 1 Classification of refrigerant
- 2 Amount of refrigerant
- 3 Classification of Compressor lubricant
- 4 Caution
- 5 Flammable Refrigerant
- 6 A registered technician must service the air conditioning system
- 7 Service manual

You can find out which air conditioning refrigerant is applied your vehicle at the label inside of the motor room.

Refer to "Refrigerant label" on page 9-6 for more detail on the location of air conditioning refrigerant label.

⚠ WARNING

- **Vehicles equipped with R-134a**



Because the refrigerant is at very high pressure, the air conditioning system should only be serviced by trained and certified technicians. It is important that the correct type and amount of oil and refrigerant is used. Otherwise, it may cause damage to the vehicle and personal injury.

- **Vehicles equipped with R-1234yf***



Since the refrigerant is mildly flammable and operated at high pressure, the air conditioning system should only be serviced by trained and certified technicians.

It is important that the correct type and amount of oil and refrigerant are used. All refrigerants should be reclaimed with proper equipment. Venting refrigerants directly to the atmosphere is harmful to individuals and environment. Failure to heed these warnings can lead to serious injuries.

⚠ CAUTION**• AC repair**

It is important that the correct type and amount of oil and refrigerant is used, otherwise, damage to the vehicle may occur. To prevent damage, the air conditioning system in your vehicle should only be serviced by trained and certified Kia technicians.

- The air conditioning system should only be used with the windows and sunroof closed to prevent condensation inside the vehicle that may cause damage to electrical components.

*** NOTICE**

- Replace the filter according to the maintenance schedule. If the vehicle is being driven in severe conditions such as dusty or rough roads, more frequent air conditioner filter inspections and changes are required.
- When the air flow rate suddenly decreases, have the system checked by a professional workshop. Kia recommends visiting an authorized Kia dealer/service partner.

Automatic climate control system



- 1 Driver's temperature control knob
- 2 Passenger's temperature control knob
- 3 **AUTO** (automatic control) button
- 4 OFF button
- 5 Fan speed control button
- 6 Mode selection button
- 7 Front-windshield defroster button
- 8 Rear-window defroster button
- 9 **SYNC** button
- 10 Air intake control button
- 11 Air conditioning **A/C** button
- 12 Driver only select button
- 13 **HEAT** button
- 14 Infotainment/climate control mode switching button

Using the infotainment/climate switchable controller

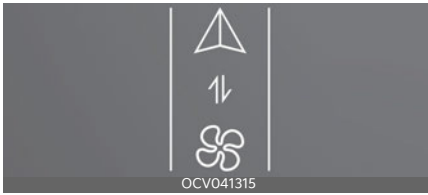

Press the button on the switchable controller to switch between infotainment system or climate control panel.

Press and hold the button to select the default mode for the control panel.

Switching between panels

Infotainment control panel

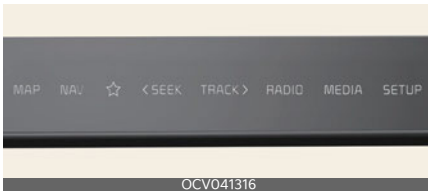

Climate control panel



Press the button on the switchable controller to select the desired control panel.

The selected control panel icon will be illuminated and the control panel will be changed.

- The knob display will be illuminated according to the selected control panel mode.

- When the vehicle is in the ACC position, only the infotainment system will be activated.

Setting the default mode



Press and hold the button to select the default mode for the control panel.

- After the setting, the control panel will return to the default mode after a certain period of time even if the control panel is switched to the different mode.
- If the mode is set to 'OFF', the control panel will display the mode used recently.

Operating the climate control system

Left-hand drive

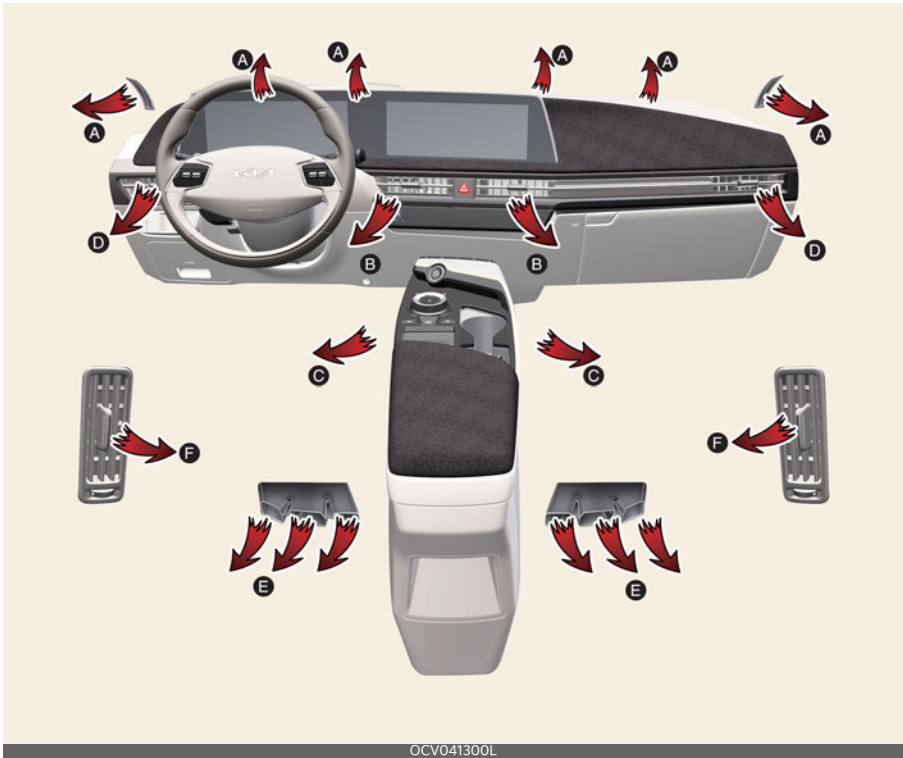

Right-hand drive

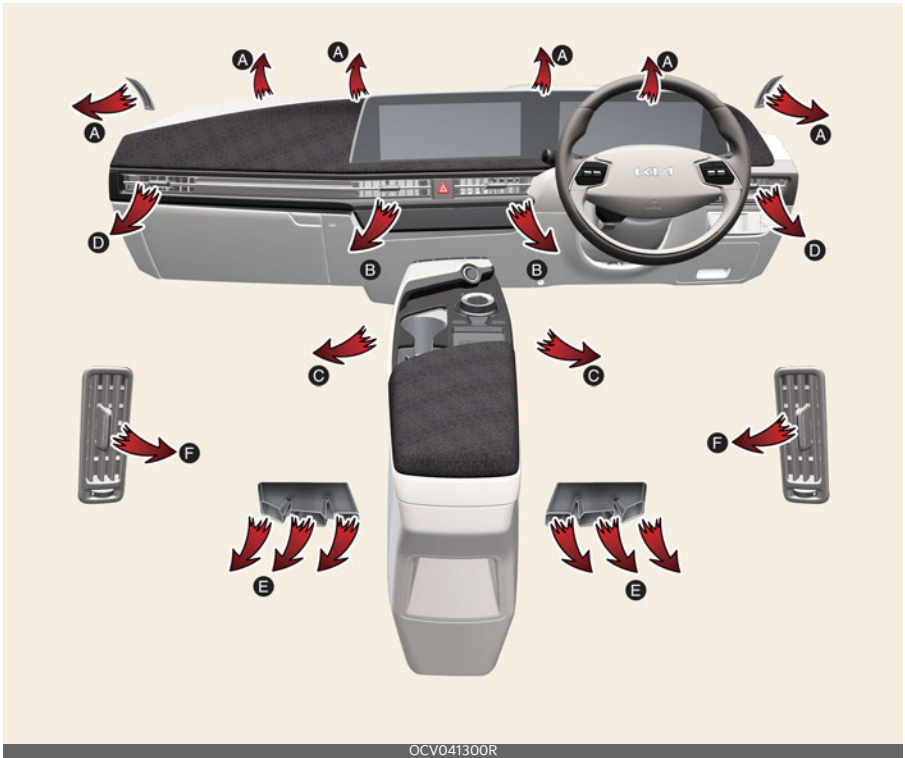

Mode	Operation	Air flow
	Air flow is directed toward the upper body and face.	B, D, F
	Air flow is directed towards the face and the floor.	B, C, D, F
	Air flow is directed toward the face, the floor and the windshield.	A, B, C, D, E, F
	Most of the air flow is directed to the floor, with a small amount of air directed to the windshield, side-window defrosters, and side air vents.	A, C, D, E
	Most of the air flow is directed to the floor and the windshield, with a small amount directed to the side-window defrosters and side air vents.	A, C, D, E
	Most of the air flow is directed to the windshield, with a small amount of air directed to the side-window defrosters and side air vents.	A, D

Operation

1. Start the vehicle.
2. Set the mode-selection buttons as desired. To improve the effectiveness of heating and cooling:
 - Heating: (🔥)
 - Cooling: (❄️)
3. Set the temperature control to the desired temperature level.
4. Set the air intake control to the position for outside (fresh) air if required.
5. Set the position of the fan speed control so that it runs at the desired speed.
6. If desired, turn the air conditioning ON with the temperature set high in order to dehumidify the air before it enters into the cabin.
If the windshield fogs up, select the Front Defrost (👤) mode.

Selecting air flow modes



Operation

- Select the direction of the air flow through the ventilation system.
The air flow outlet ports are enabled in the following sequence:



Controlling the air intake

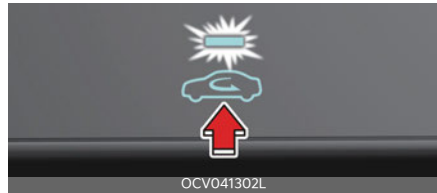

Operation

- Select the outside (fresh) air position or recirculated air position.
- Outside (fresh) air position: Air enters the vehicle from outside. The indicator light will turn off.
- Recirculated air position: Air from the passenger compartment will be drawn back into the heating system. The indicator light illuminates.

Controlling the instrument panel vents

Front



Rear



Operation

- Adjust the direction of air delivered from the vents.

Air conditioning A/C



Operation

- Press the **A/C** button.

Controlling heating and air conditioning automatically



Operation

- Set the desired temperature.
- Press the **AUTO** button to control:
 - Mode
 - Fan speed
 - Air intake
 - Air conditioning

Level	Indicator	LCD Display	Air flow
High			1-8 (EU) 2-8
Medium			1-6
Low			1-4

Controlling the temperature



Operation

- Turn the knob left or right to the desired temperature.

Adjusting the driver and passenger side temperature to the same value

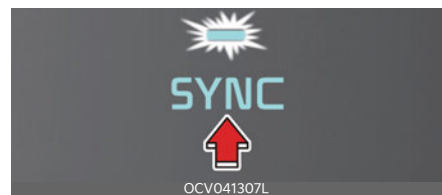

Operation

- Press the **SYNC** button.
- Turn the driver's side temperature control knob.

Changing temperature scale

Operation

- Go to **Settings** → **Units** → **Temperature** on the infotainment system.

Controlling fan speed

Operation

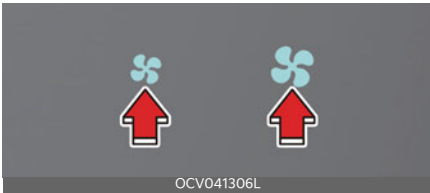

- Press the left or right button to adjust the speed.



- Press the knob to turn the blowers off.

⚠ WARNING

- Continuously using the climate control system in the recirculated air position may allow humidity to increase inside the vehicle which may fog the glass and obscure visibility.
- Do not sleep in a vehicle with the air conditioning or heating system on. It may cause serious harm or death due to a drop in the oxygen level and/or body temperature.

- Continuously using the climate control system in the recirculated air position can cause drowsiness or sleepiness, and loss of vehicle control. Set the air intake control to the outside (fresh) air position as much as possible while driving.

⚠ CAUTION

Operating the blower when the EV button is in the ON position could cause the battery to discharge. Operate the blower when the vehicle is running.

* NOTICE

- Prolonged operation of the heater in the recirculated air position (without air conditioning selected) may cause fogging of the windshield and side windows and make the air in the passenger compartment stale. In addition, prolonged use of the air conditioning with the re-circulated air position selected will result in excessively dry air in the passenger compartment.
- To turn the automatic operation off, select any button or switch of the following:
 - Mode selection button
 - Air conditioning button
 - Front-windshield defroster button (Press the button one more time to deselect the front windshield defroster function. The AUTO sign will illuminate on the information display once again.)
 - Fan speed control knob

The selected function will be controlled manually while other functions operate automatically.

- For your convenience and to improve the effectiveness of the climate control, use the AUTO button and set the temperature to 22 °C (72 °F).
- Never place anything over the sensor located on the instrument panel to ensure better control of the heating and cooling system.
- To help improve microphone voice input sound, fan speed may automatically slow down for a couple of minutes when you activate voice recognition or hands free.
- When charging or right after charging the high voltage battery, the cooling will be made using air conditioner system in order to control the high voltage battery temperature.

At this time, the noise might occur by the air conditioner compressor and cooling fan, but this is due to normal operation.

Windshield defrosting and defogging

Defrosting/defogging the windshield

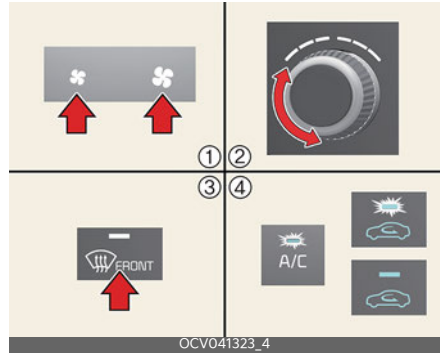

Operation

1. Set the fan speed to the desired position.
2. Select the desired temperature.
3. Select (FRONT) or (FRONT).
4. Outside (fresh) air and air conditioning will be selected automatically.

Auto defogging for automatic climate control



Operation

- **For Europe**
 - Air conditioning will turn ON.
 - Air intake control will change to Fresh mode.

- Mode will change to defrost to direct airflow to the windshield.
- Fan speed will increase.
- **Except Europe**
 - Air conditioning will turn ON.
 - Air intake control will change to Fresh mode.
 - Fan speed will increase.
 - Mode will change to defrost to direct airflow to the windshield

Canceling or resetting auto defogging

Operation

- Press (🌀) for 3 seconds.
 - The button indicator will blink 3 times if canceled.
 - The button indicator will blink 6 times if reset.

Rear window/outside mirror defroster

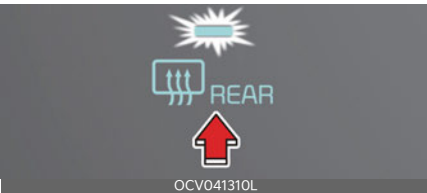

Operation

- Press the Rear-window defroster button. The indicator lights up when the defroster is ON.
- It turns OFF after approximately 20 minutes or when the vehicle is in OFF position.

Heat button

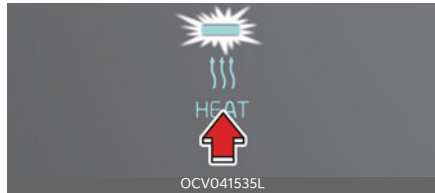

Operation

- Press the heat button. The indicator illuminates when the heat function is ON.
- The air conditioner and heater uses energy from the battery. If you use the heater or air conditioner for too long, distance to empty can be reduced due to too much power consumption.

⚠️ WARNING

- Do not use the (🌀) or (🌀) position during cooling operation in extremely humid weather. The difference between the temperature of the outside air and the windshield could cause the outer surface of the windshield to fog up, causing loss of visibility. In this case, set the mode selection to the (🌀) position and fan speed control to the lower speed.
- Continued use of the climate control system operation in Recirculation mode for a prolonged period of time may cause drowsiness to the occupants in the cabin. This may lead to loss of vehicle control which may lead to an accident.
- Continued use of the climate control system operation in Recirculation mode with the air conditioning OFF may allow humidity to increase inside the cabin. This may cause condensa-

- tion to accumulate on the windshield and obscure visibility.
- Do not sleep in your vehicle or remain parked in your vehicle with the windows up and either the heater or the air conditioning ON for prolonged periods of time. Doing so may increase the levels of carbon dioxide in the cabin which may lead to serious injury or death.

⚠ CAUTION

To prevent damage to the conductors bonded to the inside surface of the rear window, never use sharp instruments or window cleaners containing abrasives to clean the window.

* NOTICE

- When the air conditioning is turned on by Auto defogging system, if you try to turn off the air conditioning, the air conditioning will not be turned off.
- To maintain the effectiveness and efficiency of the Auto Defogging System, do not select Recirculation mode while the system is operating.
- When the Auto Defogging System is operating, the fan speed adjustment knob, the temperature adjustment knob, and the air intake control button are all disabled.
- Do not remove the sensor cover located on the upper end of the driver side windshield glass.
Damage to system parts could occur and may not be covered by your vehicle warranty.

- If the battery (12V) is discharged or disconnected, Auto dehumidify settings will be reset. Readjust the settings to turning Auto dehumidify option ON or OFF. For detailed information, refer to Navigation Quick Reference Guide.

Auto. controls that use climate control settings (if equipped)

The temperature of the driver's seat warmer, air ventilated seat and heated steering wheel is automatically controlled depending on the inside and outside temperature of the vehicle when the vehicle is running.

Operation

- Select **Settings** → **Vehicle** → **Seat** → **Heating/Ventilation** → **Auto. Controls That Use Climate Control Settings** → **Steering wheel warmer/Seat warmer/ventilation** on the infotainment screen.
- The heated steering wheel and seat warmer/ventilation defaults to the OFF position whenever the vehicle is restarted. However, if the "Auto. controls that use climate control settings" is ON, the heated steering wheel and seat warmer/ventilation will turn on and off depending on the inside and outside temperature.

* NOTICE

For detailed information, refer to Navigation Quick Reference Guide.

Smart ventilation (if equipped)

The smart ventilation system maintains pleasant/fresh air conditioning inside the passenger compartment by automatically detecting/controlling the temperature and humidity level, when you drive the vehicle with the climate control system in OFF position. When the smart ventilation system starts to operate, the message appears for approximately 5 seconds.

The smart ventilation system stops when:

- OFF button is selected.
- Any of the button of the climate control is selected for operation.

* NOTICE

The smart ventilation system may not operate when the vehicle is driven at low speed.

Storage compartment

Center console storage/glove box



Operation

- Pull the lid upward to open the center console storage.
- Push the button of the glove box, and it will open.
- There is a hook for charging cable fixing on the upper part of the center console storage.

⚠ WARNING

- To reduce the risk of personal injury in the event of sudden stop or collision, do not place uncovered or unsecured bottles, glasses, cans, etc., in the storage compartment while the vehicle is in motion.
- Do not store glasses, gas lighter, portable battery, canned beverage, spray can, propane cylinder, cosmetic tube or other flammable/explosive materials in the vehicle. These items may catch fire and/or explode if the vehicle is exposed to hot temperatures for extended periods.
- To reduce the risk of injury in an accident or sudden stop, always keep the glove box door closed while driving.

- Do not hang any other items (e.g., plastic bags) on the charging cable fixing hook. It is dangerous to hang objects other than intended use, as the items may fall while driving and interfere with the brake pedal.

⚠ CAUTION

- To avoid possible theft, do not leave valuables in the storage compartment.
- Always keep the storage compartment covers closed while driving. Do not attempt to place so many items in the storage compartment that the storage compartment cover cannot close securely.
- Do not keep food in the glove box for a long time.

*** NOTICE**

If the armrest does not open in the event of a collision, slide the armrest from the driver's side to the passenger's side seat.

Luggage tray



Operation

1. Grab the cover handle and lift the cover.
2. Fold the rear luggage board to the front.
3. Lift the luggage board up.

*** NOTICE**

The maximum load weight for the luggage tray is 60 kg (130 lbs.)

Luggage net holder



There are 4 holders located in the cargo area.

⚠ WARNING

Avoid eye injury. Do not overstretch the luggage net. Always keep your face and body out of the luggage net's recoil path. Do not use when the strap has visible signs of wear or damage.

⚠ CAUTION

To prevent damage to the goods or the vehicle, care should be taken when carrying fragile or bulky objects in the luggage compartment.

Cargo security screen

Installing the cargo security screen

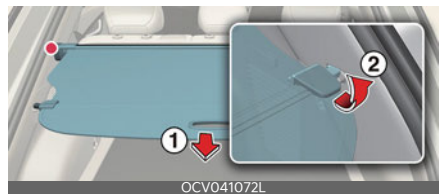

- 1 Cargo security screen handle
- 2 Cargo security screen guide

Operation

1. Pull the cargo security screen towards the rear of the vehicle by the handle (1).
2. Insert the guide pin into the guide (2).

Removing the cargo security screen



Operation

1. Push the guide pin in the direction.
2. Pull the cargo security screen out.
3. Open the luggage tray and keep the cargo security screen in the tray.

Removing the cargo security screen from luggage tray



Operation

1. Pull the luggage tray board up.
2. Push the guide pin into the center.
3. While pushing the guide pin, pull out the cargo security screen.

4. The luggage side tray can be removed to remove the cargo security screen more easily.

⚠ WARNING

- Do not place objects on the cargo security screen. Such objects may move around inside the vehicle and possibly injure vehicle occupants during an accident or when braking.
- Never allow anyone to ride in the luggage compartment. It is designed for luggage only.
- Maintain the balance of the vehicle and locate the weight as forward as possible.

* NOTICE

- Since the cargo security screen may be damaged or malformed, do not put luggage on it when it is used.
- Pull out the cargo security screen using the handle in the center to prevent the guide pin from falling out of the guide.
- The cargo security screen may not automatically slide back in if the cargo security screen is not fully pulled out. Fully pull it out and then let go.
- The cargo security screen and rear seat may be damaged when the rear seatback is reclined.
- Note that if you release the handle while pulling the luggage screen handle all the way, the screen may wind up quickly and be damaged.

Interior features

Ambient lights (if equipped)



The ambient lights are installed in the front crash pad, front doors, and the top/bottom of the center console.

Cup holders



Cups or small drink cans can be placed in the cup holders.

⚠ WARNING

- Do not place uncovered cups with hot liquid in the cup holder while the vehicle is in motion. If the hot liquid spills, you burn yourself. Such a burn to the driver could lead to loss of control of the vehicle.
- To reduce the risk of personal injury in the event of sudden stop or collision, do not place uncovered or unsecured bottles, glasses, cans, etc., in the cup holder while the vehicle is in motion.

- Keep cans or bottles out of direct sun light and do not put them in a vehicle that is heated up. It may explode.

*** NOTICE**

- Keep your drinks sealed while driving to prevent spilling your drink. If liquid spills, it may get into the vehicle's electrical/electronic system and damage electrical/electronic parts.
- When cleaning spilled liquids, do not dry the cup holder at high temperature. This may damage the cup holder.

Seat warmer/ventilation (if equipped)

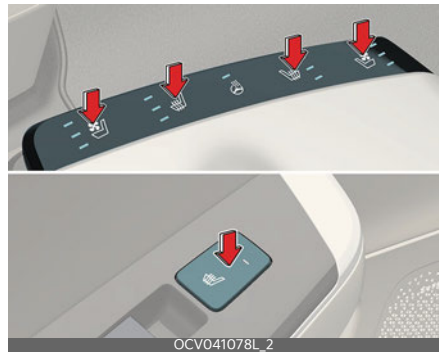

The seat warmer/ventilation is provided to warm/cool the front seats.

* The seat ventilation is provided only on the front seats.

Operation

- Push either of the buttons to warm the driver's seat or the front passenger's seat.
- It defaults to the OFF position when the vehicle is in the ON position.

- The seat warmer/ventilation automatically controls the seat temperature depending on the ambient temperature when the vehicle is running. For more details, refer to "Auto. controls that use climate control settings (if equipped)" on page 5-85.
- The temperature setting of the seat will change as follows:

Temperature	Duration
OFF	-
High	30 minutes
Medium	60 minutes
Low	-

⚠ WARNING

The seat warmers can cause a **SERIOUS BURN**, even at low temperatures and especially if used for long periods of time. Passengers must be able to feel if the seat is becoming too warm so they can turn it off, if needed.

Seat warmers consumes huge amount of electricity. Please avoid using seat warmers while the vehicle is off in order to prevent the battery discharge.

People who cannot detect temperature change or pain to the skin should use extreme caution, especially the following types of passengers:

- Infants, children, elderly or handicapped persons, or hospital outpatients
- Persons with sensitive skin or those that burn easily
- Fatigued individuals
- Intoxicated individuals
- Individuals taking medication that can cause drowsiness or sleepiness (sleeping pills, cold tablets, etc.)

⚠ CAUTION

- When cleaning the seats, do not use an organic solvent such as paint thinner, benzene, alcohol and gasoline. Doing so may damage the surface of the heater or seats.
- To prevent overheating the seat warmer, do not place anything on the seats that insulates against heat, such as blankets, cushions or seat covers while the seat warmer is in operation.
- Do not place heavy or sharp objects on seats equipped with seat warmers. Damage to the seat warming components could occur.
- Do not change the seat cover. It may damage the seat warmer or air ventilation system.
- When cleaning the seats, do not use an organic solvent such as paint thinner, benzene, alcohol and gasoline. Doing so may damage the air ventilation seat.

*** NOTICE**

With the seat warmer buttons in the ON position, the heating system in the seat turns off or on automatically depending on the seat temperature.

Sun visor

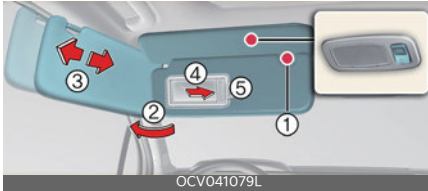

Operation

1. Pull down and unsnap it from the bracket (1).
2. Swing it to the side (2).
 - Slide the sun visor if necessary (3).
 - Pull down and slide the mirror cover (4) to use the vanity mirror.
 - The ticket holder (5) is provided for the purpose of holding a tollgate ticket.

⚠ WARNING

For your safety, do not block your view when using the sun visor.

*** NOTICE**

- Do not put several tickets in the ticket holder at one time. This could cause damage to the ticket holder.
- Always have the switch in the off position when the vanity mirror lamp is not in use. If the sun visor is closed without the lamp off, it may discharge the battery or damage the sun visor.

USB charger



The USB charger allows drivers and passengers to charge their digital devices such as smart phones and tablets.

*** INFORMATION**

- Quick Charge 2.0 is available on the smart phone or the table PC equipped with fast charging capabilities. The applicable is as follows: (<https://www.qualcomm.com/documents/quickcharge-device-list>) The smart phone or PC tablet without fast charging is charged at a regular speed.
- Rated output
 - Digital devices with fast charging: 9.0 V, 1.67 A
 - Digital devices with normal charging: 5.0 V, 2.1 A

⚠ CAUTION

- Use the USB car charger with the vehicle on. Otherwise, Vehicle battery can be discharged.
- Use the official USB cable of the manufacturer of the digital device to be charged.
- Make sure that any foreign object, drinks, and water do not come into contact with the USB car charger. Water or foreign object can damage the USB charger.
- Do not use the device those current consumption exceeds 2.1 A.
- Do not connect an electrical device that generates excessive electromagnetic noise to the USB car port. If you do so, noise can be caused or vehicle electronic devices can be interrupted while audio or AV is on.
- If the charger is connected incorrectly, it can cause serious damage on the devices. Please note that damages due to incorrect usage are not covered by warranty service.

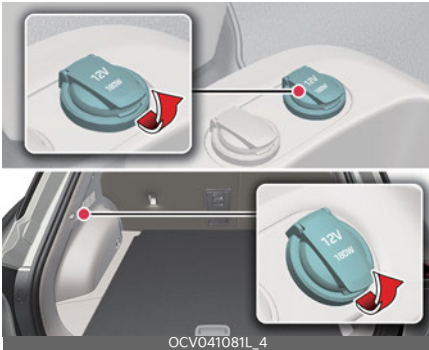
Power outlet

The power outlet allows drivers and passengers to charge their digital devices such as smart phones and tablets.

Operating condition(s)

- The devices should draw less than 15 A when The vehicle is in the ON position.

⚠ WARNING

- Use the power outlet only when the vehicle is on and remove the accessory plug after use. Using the accessory plug for prolonged periods of time with the vehicle off could cause the battery to discharge.
- Only use 12 V electric accessories which are less than 15 A in electric capacity.
- Adjust the air-conditioner or heater to the lowest operating level when using the power outlet.
- Close the cover when not in use.
- Some electronic devices can cause electronic interference when plugged into a vehicle's power outlet. These devices may cause excessive audio static and malfunctions in other electronic systems or devices used in your vehicle.
- Push the plug in as far as it will go. If good contact is not made, the plug may overheat and the fuse may open.
- Plug in battery equipped electronic devices with reverse current protection. The current from the battery may flow into the vehicle's electrical/electronic system and cause system malfunction.
- Do not put a finger or a foreign object (pen, etc.) into a power outlet and do not touch with a wet hand. You may get an electric shock.

Wireless smartphone charging system (if equipped)

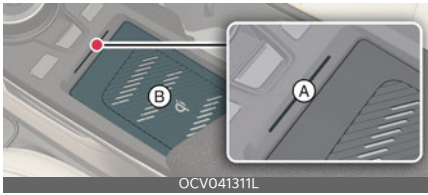

A: Indicator

B: Charging pad

Operation

- Place the smartphone at the center of the wireless charging pad.
- The indicator light will change to orange once the wireless charging begins. The light will change to green when charging is complete.
- You can choose to turn the wireless charging function ON or OFF through the infotainment system.

Operating condition(s)

- The wireless charging system is designed for one smart phone equipped with Qi charging only.

* INFORMATION

- If the wireless charging does not work, gently move your smart phone around the pad until the charging indicator light turns orange. Depending on the smart phone, the charging indicator light may not turn green even after the charging is complete.
- If the wireless charging is not functioning properly, the orange light will blink and flash for ten seconds then turn off. In such cases, remove the smart phone from the pad and

replace it on the pad again, or double check the charging status.

⚠ WARNING

If any metallic object such as coins is located between the wireless charging system and the smart phone, the charging may be disrupted. Also, the metallic object may heat up.

⚠ CAUTION

- When the interior temperature of the wireless charging system rises above a set temperature, the wireless charging will cease to function. After the interior temperature drops below the threshold, the wireless charging function will resume.
- If there is any metallic object between the smart phone and the wireless charging pad, immediately remove the smart phone. Remove the metallic object after it has completely cooled down.
- The wireless charging may not function properly when there is a heavy accessory cover on the smart phone.
- The wireless charging will stop when using the wireless smart key search function to prevent radio wave disruption.
- The wireless charging will stop when the smart key is moved out of the vehicle in ON position.
- The wireless charging will stop when any of the doors is opened (applicable for vehicles equipped with smart keys).
- The wireless charging will stop when the vehicle is turned OFF.
- The wireless charging will stop when the smart phone is not in complete

contact with the wireless charging pad.

- Items equipped with magnetic components such as credit card, telephone card, bankbook, any transportation ticket and such may become damaged during wireless charging.
- Place the smart phone on the center of the charge pad for best results. The smart phone may not charge when placed near the rim of the charging pad. When the smart phone does get charged, it may heat up excessively.
- For smart phones without built-in wireless charging system, an appropriate accessory has to be equipped.
- Smart phones of some manufacturers may display messages on weak current. This is due to the particular characteristic of the smart phone and does not imply a malfunction on wireless charging function.
- The indicator light of some manufacturers' smart phones may still be orange after the smart phone is fully charged. This is due to the particular characteristic of the smart phone and not a malfunction of the wireless charging.
- When any smart phone without a wireless charging function or a metallic object is placed on the charging pad, a small noise may sound. This small sound is due to the vehicle discerning compatibility of the object placed on the charging pad. It does not affect your vehicle or the smart phone in any way.

- The wireless cellular phone charging system may not support certain cellular phones, which are not verified for the Qi specification (Qi).
- For certain cellular phones with their own protection, the wireless charging speed may decrease and the wireless charging may stop.

*** NOTICE**

For some manufacturers' smart phones, the system may not warn you even though the smart phone is left on the wireless charging unit. This is due to the particular characteristic of the smart phone and not a malfunction of the wireless charging.

Coat hook

A coat hook is next to the left rear grab handle.

⚠ WARNING

Do not hang other objects such as hangers or hard objects except clothes. Also, do not put heavy, sharp or breakable objects in the clothing's pockets. In an accident or when the curtain air bag is inflated, it may cause vehicle damage or body injury.

⚠ CAUTION

Do not hang heavy clothes, since they may damage the hook.

Floor mat anchors

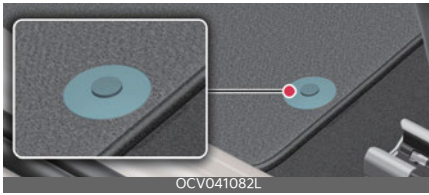

Make sure the floor mat is attached to the anchors to keep it from sliding forward.

⚠ WARNING

- Do not install after market floor mats that are not capable of being securely attached to the vehicle's floor mat anchors. Unsecured floor mats can interfere with pedal operation.
- Use floor mats not too thick and designed to be properly secured on the floor to avoid the interference with pedals. Make sure that installing the floor mats without removing plastic films on carpets may damage or break floor mat fix rings, resulting in the mats to be unsecured. Especially for a driver's seat, the unsecured mats may cause unintended acceleration/brake. Ensure to remove all the plastic films on the carpets before installing the mats.

Infotainment system

Using the infotainment/climate switchable controller



Press the button on the switchable controller to switch between infotainment system or climate control panel.

Press and hold the button to select the default mode for the control panel.

Switching between panels

Infotainment control panel



Climate control panel



Press the button on the switchable controller to select the desired control panel.

The selected control panel icon will be illuminated and the control panel will be changed.

- The knob display will be illuminated according to the selected control panel mode.

- When the vehicle is in the ACC position, only the infotainment system will be activated.

Setting the default mode



Press and hold the button to select the default mode for the control panel.

- After the setting, the control panel will return to the default mode after a certain period of time even if the control panel is switched to the different mode.
- If the mode is set to 'OFF', the control panel will display the mode used recently.

Audio system

Sharkfin antenna



The roof antenna transmits and receives wireless signals such as AM/FM, DAB, GNSS, LTE etc.

* The signals which antenna can transmit and receive vary by the vehicle option.

* NOTICE

- If you install an aftermarket HID head lamp, your vehicle's audio and electronic device may malfunction.

- Avoid adding metallic coatings such as Ni, Cd, etc. These can degrade the receiving AM and FM broadcast signals.

USB port



You can use an USB port to plug in the USB.

⚠ WARNING

Do not use a cellular phone while driving. Stop at a safe location to use a cellular phone.

⚠ CAUTION

- Depending on the size, length, or shape of the USB stick, the USB device may be damaged or deformed. When the stick is stuck, forcibly pulling the USB stick can cause damage to the port. If the USB stick does not fit, do not forcibly push the USB stick to the port and try another USB stick with different specifications.
- When using a communication system such as a cellular phone or a radio set inside the vehicle, a separate external antenna must be fitted. When a cellular phone or a radio set is used with only the internal antenna, it may interfere with the vehicle's electrical system and adversely affect the safe operation of the vehicle.

Before driving	6-6
• Necessary vehicle inspections.....	6-6
• Good driving practices	6-6
• Good braking practices.....	6-7
Vehicle power	6-8
• Starting the vehicle.....	6-8
Reduction gear	6-10
• Changing gear.....	6-10
• Shift-lock system.....	6-11
• LCD display messages.....	6-13
Regenerative braking system	6-15
• Adjusting regenerative braking with paddle shifter	6-15
• One pedal driving	6-15
• i-Pedal	6-16
Smart regeneration system	6-17
• Operating smart regeneration system	6-17
• Smart regeneration system malfunction and limitations.....	6-18
Brake system	6-22
• In the event of brake failure.....	6-22
• Brake disc cleaning.....	6-22
• Parking brake	6-23
• AUTO HOLD	6-27
Vehicle safety system	6-28
• Anti-lock Brake System (ABS)	6-28
• Electronic Stability Control (ESC)	6-28
• Hill-start Assist Control (HAC)	6-29
• Multi-Collision Brake (MCB)	6-29
• Vehicle Stability Management (VSM).....	6-30
• Emergency Stop Signal (ESS)	6-31
• Brake Assist System (BAS).....	6-31

6 Driving your vehicle

Drive mode integrated control system	6-32
• DRIVE MODE	6-32
• DRIVE MODE characteristics for 4WD	6-33
All wheel drive (4WD)	6-34
• For safe 4WD operation	6-34
• Emergency precautions	6-36
Active air flap	6-37
• Active air flap malfunction	6-37
Forward Collision-Avoidance Assist (FCA)	6-38
• Forward Collision-Avoidance Assist settings	6-41
• Forward Collision-Avoidance Assist operation	6-43
• Forward Collision-Avoidance Assist malfunction and limitations	6-50
Lane Keeping Assist (LKA)	6-57
• Lane Keeping Assist settings	6-57
• Lane Keeping Assist operation	6-58
• Lane Keeping Assist malfunction and limitations	6-60
Blind-Spot Collision-Avoidance Assist (BCA)	6-62
• Blind-Spot Collision-Avoidance Assist settings	6-64
• Blind-Spot Collision-Avoidance Assist operation	6-65
• Blind-Spot Collision-Avoidance Assist malfunction and limitations	6-68
Safe Exit Warning (SEW)	6-72
• Safe Exit Warning settings	6-73
• Safe Exit Warning operation	6-74
• Safe Exit Warning malfunction and limitations	6-75
Safe Exit Assist (SEA)	6-76
• Safe Exit Assist settings	6-77
• Safe Exit Assist operation	6-78
• Safe Exit Assist malfunction and limitations	6-79

Manual Speed Limit Assist (MSLA)	6-81
• Manual Speed Limit Assist operation.....	6-81
Intelligent Speed Limit Assist (ISLA)	6-83
• Intelligent Speed Limit Assist settings.....	6-84
• Intelligent Speed Limit Assist operation.....	6-85
• Intelligent Speed Limit Assist malfunction and limitations.....	6-86
Driver Attention Warning (DAW)	6-88
• Driver Attention Warning settings	6-89
• Driver Attention Warning operation	6-90
• Driver Attention Warning malfunction and limitations.....	6-92
Blind-Spot View Monitor (BVM)	6-94
• Blind-Spot View Monitor settings	6-94
• Blind-Spot View Monitor operation.....	6-94
• Blind-Spot View Monitor malfunction.....	6-95
Cruise Control (CC)	6-95
• Cruise Control operation.....	6-95
Smart Cruise Control (SCC)	6-98
• Smart Cruise Control settings.....	6-98
• Smart Cruise Control operation.....	6-102
• Smart Cruise Control display and control	6-103
• Smart Cruise Control malfunction and limitations	6-107
Navigation-based Smart Cruise Control (NSCC)	6-112
• Navigation-based Smart Cruise Control settings	6-112
• Navigation-based Smart Cruise Control operation.....	6-113
• Navigation-based Smart Cruise Control limitations	6-114
Lane Following Assist (LFA)	6-117
• Lane Following Assist settings.....	6-118
• Lane Following Assist operation.....	6-118
• Lane Following Assist malfunction and limitations.....	6-120

6 Driving your vehicle

Highway Driving Assist (HDA)	6-120
• Highway Driving Assist settings	6-121
• Highway Driving Assist operation	6-122
• Highway Driving Assist malfunction and limitations.....	6-128
Rear View Monitor (RVM)	6-130
• Rear View Monitor settings	6-130
• Rear View Monitor operation.....	6-131
• Rear View Monitor malfunction and limitations.....	6-132
Surround View Monitor (SVM)	6-133
• Surround View Monitor settings.....	6-134
• Surround View Monitor operation.....	6-135
• Surround View Monitor malfunction and limitations.....	6-136
Rear Cross-Traffic Collision-Avoidance Assist (RCCA)	6-137
• Rear Cross-Traffic Collision-Avoidance Assist settings	6-138
• Rear Cross-Traffic Collision-Avoidance Assist operation.....	6-139
• Rear Cross-Traffic Collision-Avoidance Assist malfunction and limitations	6-142
Reverse Parking Distance Warning (PDW)	6-145
• Reverse Parking Distance Warning settings.....	6-145
• Reverse Parking Distance Warning operation.....	6-146
• Reverse Parking Distance Warning malfunction and precautions.....	6-147
Forward/Reverse Parking Distance Warning (PDW)	6-148
• Forward/Reverse Parking Distance Warning settings.....	6-149
• Forward/Reverse Parking Distance Warning operation.....	6-149
• Forward/Reverse Parking Distance Warning malfunction and precautions	6-151
Reverse Parking Collision-Avoidance Assist (PCA)	6-153
• Reverse Parking Collision- Avoidance Assist settings.....	6-153
• Reverse Parking Collision- Avoidance Assist operation	6-154

• Reverse Parking Collision- Avoidance Assist malfunction and limitations.....	6-155
Remote Smart Parking Assist (RSPA)	6-159
• Remote Smart Parking Assist settings	6-161
• Remote Smart Parking Assist operation.....	6-162
• Remote Smart Parking Assist malfunction and limitations.....	6-177
Declaration of conformity	6-181
Special driving conditions	6-187
Winter driving.....	6-190
Trailer towing.....	6-193
• Hitches	6-194
• Safety chains.....	6-195
• Trailer brakes.....	6-195
• Driving with a trailer.....	6-195
• Maintenance when towing a trailer	6-197
• If you do decide to tow a trailer.....	6-198
Vehicle weight	6-199
• Base curb weight.....	6-199
• Vehicle curb weight.....	6-199
• Cargo weight.....	6-199
• GAW (Gross axle weight).....	6-199
• GAWR (Gross axle weight rating)	6-199
• GVW (Gross vehicle weight).....	6-200
• GVWR (Gross vehicle weight rating).....	6-200
• Overloading.....	6-200
• Loading Your Vehicle - For Australia	6-200

Driving your vehicle

Before driving

Necessary vehicle inspections

Be sure to check the following fluid levels on a regular basis at the exact interval:

- Brake fluid
- Washer fluid

For more details, refer to "Maintenance" on page 8-3.

WARNING

Focus on the road while driving. The driver's primary responsibility is in the safe and legal operation of the vehicle. Use of any handheld devices, other equipment or vehicle systems that distract the driver should not be used during vehicle operation.

Before entering vehicle

- Be sure that all windows, outside mirrors, and outside lights are clean.
- Check the condition of the tires.
- Check under the vehicle for any sign of leaks.
- Make sure there are no obstacles behind you if you intend to back up.

Before starting the vehicle

- Close and lock all doors.
- Position the seat so that all controls are easily reached.
- Buckle your seat belt.
- Adjust both inside and outside rear view mirrors.
- Be sure that all lights work.
- Check all gauges.

- Check the operation of warning lights when the vehicle is in the ON position.
- Release the parking brake and make sure the brake warning light is off.

WARNING

- Always check the surrounding areas near your vehicle for people, especially children, before putting a vehicle into D (Drive) or R (Reverse).
- Securely store items in your vehicle. When you make a sudden stop or turn the steering wheel rapidly, loose objects may drop on the floor and it could interfere with the operation of the foot pedals, possibly causing an accident.
- Do not drive while under the influence of alcohol, drugs, or other impairing substances. Drinking and driving is dangerous. Even a small amount of alcohol will affect your reflexes, perceptions and judgment.
Driving while under the influence of drugs or other impairing substances is as dangerous as or more dangerous than driving drunk.
- Always wear appropriate shoes when operating your vehicle. Unsuitable shoes (high heels, ski boots, sandals, etc.) may interfere with your ability to use the brake and accelerator pedals.

Good driving practices

- Never shift from P or N to any other position with the accelerator pedal pressed.
- Never shift to P when the vehicle is moving.
- Stop the vehicle completely before shifting to R or D.

- Never change the gear to N and coast down the hill. This is extremely hazardous. Always make sure that the vehicle is in R or D when it is moving.
- Always use the parking brake. Do not depend on P to keep the vehicle from moving.
- Exercise extreme caution when driving on a slippery surface. Be especially careful when braking, accelerating, or shifting gears. The vehicle speed can change abruptly, causing the tires to lose traction and the vehicle to lose control.
- Do not make quick steering wheel movements, such as sharp lane changes or fast, sharp turns.
- The risk of a rollover is greatly increased if you lose control of your vehicle at highway speeds.
- Losing control often occurs if two or more wheels drop off the roadway and the driver oversteers to reenter the roadway.
- In the event your vehicle leaves the roadway, do not steer sharply. Instead, slow down before pulling back into the travel lanes.
- Never exceed posted speed limits.

WARNING

- If your vehicle becomes stuck in snow, mud, sand, etc., then you may attempt to rock the vehicle free by moving it forward and backward. Do not attempt this procedure if people or objects are anywhere near the vehicle. During the rocking operation the vehicle may suddenly move forward or backward as it becomes unstuck, causing injury or damage to nearby people or objects.
- When driving uphill or downhill, always shift to D (Drive) for driving forward or shift to R (Reverse) for driving backwards, and check the gear position indicated on the cluster before driving. Driving in the opposite direction of the selected gear can lead to a dangerous situation by shutting off the vehicle and affecting the braking performance.
- ALWAYS wear your seat belt. In a collision, an unbelted occupant is significantly more likely to be seriously injured or killed than a properly belted occupant.
- Avoid high speeds when cornering or turning.

Good braking practices

- Be sure the parking brake is not engaged and the parking brake indicator light is off before driving.
- The vehicle will not stop as quickly if the brakes are wet. Apply the brakes lightly until the braking action returns to normal.
- If you get a flat tire while driving, apply the brakes gently and keep the vehicle straight ahead while it slows down. Pull the vehicle slowly and safely off the road and stop in a safe place.
- Be cautious when parking on a hill. Firmly engage the parking brake and shift to P.
- If your vehicle is facing downhill, turn the front wheels into the curb to help keep the vehicle from rolling. If your vehicle is facing uphill, turn the front wheels away from the curb to help keep the vehicle from rolling.

- Block the wheels if there is no curb or if it is required by other conditions to keep the vehicle from rolling.
- The parking brake can freeze in the engaged position under certain conditions such as snow or ice around or near the rear brakes or if the brakes are wet.

If there is risk of the parking brake freezing, apply it only temporarily while shifting to P and block the rear wheels so that the vehicle cannot roll. Then, release the parking brake.

- Do not hold the vehicle on an incline with the accelerator pedal. This can cause the reduction gear to overheat. Always use the brake pedal or parking brake.
- Do not pump the brake pedal as the vehicle is equipped with ABS.
- The vehicle is equipped with electronic hydraulic brake. Due to malfunction or power instability, the brake booster may not operate normally and cause the brake pedal to feel stiff, resulting in longer braking distances. In this case, stop the vehicle by depressing the brake pedal stronger than usual. Have the system inspected by a professional workshop. Kia recommends visiting an authorized Kia dealer/service partner.
- The sound of electronic hydraulic brake operating or its motor may be heard temporarily when:
 - Repeatedly depressing the brake pedal
 - Opening driver's door

Vehicle power

Starting the vehicle

Power button



Operation

- OFF
 - Press the EV button in P to turn the vehicle off.
- ACC (Accessory)
 - Press the EV button once without depressing the brake pedal.
 - The steering wheel is unlocked.
 - The electrical accessories can be operated.
 - Turns off automatically after approximately 1 hour to prevent battery discharge.
- ON
 - Press the EV button twice without depressing the brake pedal.
 - The warning lights can be checked.
- START/RUN
 - Press the EV button while depressing the brake pedal in P or N.
 - Start the vehicle in P for the safety.

EV button interlock system

The EV button will not change to the OFF position unless the vehicle is in P (Park).

Vehicles equipped with an anti-theft steering column lock

The steering wheel is locked when:

- The vehicle is in the OFF position
- The doors are opened

Starting the vehicle with smart key

The vehicle will check for the smart key when:

- The vehicle doors are opened
- The EV button is pressed

If the smart key is not in the vehicle, the indicator (🔑) and the message will appear on the instrument cluster.

⚠️ WARNING

- Never press the EV button while the vehicle is in motion. This would result in loss of directional control and braking function, which could cause an accident.
- Before leaving the driver's seat, always make sure the gear is shifted to P (Park) position, set the parking brake fully and shut the vehicle off. Unexpected and sudden vehicle movement may occur if these precautions are not taken.
- Never reach for the EV button or any other controls through the steering wheel while the vehicle is in motion. The presence of your hand or arm in the area could cause loss of vehicle control, an accident and serious bodily injury or death.
- Do not place any movable objects around the driver's seat as they may move while driving, interfere with the driver and lead to an accident.

- The vehicle will start, only when the smart key is in the vehicle. Never allow children or any person who is unfamiliar with the vehicle touch the EV button or related parts. Pushing the EV button while the smart key is in the vehicle may result in unintended vehicle activation and/or unintended vehicle movement.

⚠️ CAUTION

- In an emergency situation while the vehicle is in motion, you are able to turn the vehicle off and to the ACC position by pressing the EV button for more than 2 seconds or 3 times repeatedly within 3 seconds. If the vehicle is still moving, to restart the vehicle:
 - Press the EV button when vehicle speed is over approximately 5 km/h (3 mph).
- If the vehicle is turned off while the vehicle is in motion, do not attempt to move the gear to the P (Park) position. If the traffic and road conditions permit, you may put the gear in the N (Neutral) position while the vehicle is still moving and press the EV button in an attempt to restart the vehicle.
- Do not press the EV button for more than 10 seconds except when the stop lamp fuse is blown.
- You can also start the vehicle when the gear is in the N (neutral) position, but for safety, be sure to start the vehicle only when the gear is in the P (Park) position.

* NOTICE

- If you leave the EV button in the ACC or ON position for a long time, the battery will discharge.
- If you press the EV button without pressing the brake pedal, the vehicle will not start and the EV button changes as follow:
 - OFF → ACC → ON → OFF or ACC
- If the steering wheel doesn't unlock properly, the EV button will not work. Press the EV button while turning the steering wheel right and left to release the tension.
- You are able to turn off the vehicle only when the vehicle is not in motion.
- If the battery is weak or the smart key does not work correctly, you can start the vehicle by pressing the EV button with the smart key. When you press the EV button directly with the smart key, the smart key should contact the button at a right angle.



- When the stop lamp fuse is blown, you cannot start the vehicle normally. Replace the fuse with a new one. If it is not possible, you can start the vehicle by pressing the EV button for 10 seconds while it is in the ACC position. The vehicle can start without pressing the brake pedal. But for your safety always press the brake pedal before starting the vehicle.

Reduction gear

Changing gear

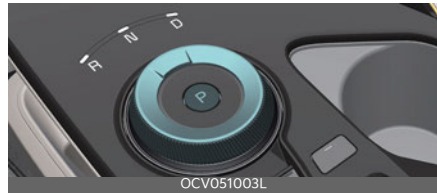

Operation

- Turn the shift dial.
- Press P button to shift to P (Park).

Gear position

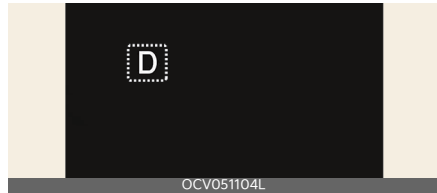

The indicator in the instrument cluster displays the gear position when the EV button is in ON position.

Automatic shift to P (Park)

Operating condition(s)

- The driver door is opened in R (Reverse), N (Neutral), D (Drive) while vehicle is in ON position.
- The vehicle is in OFF position while the gear is in R (Reverse), N (Neutral), D (Drive).

Non-operating condition(s)

- When the vehicle is above certain speed

N (Neutral) in vehicle ON/ACC position

If you want to stay in N (Neutral) when the vehicle is in the ACC or ON state, do the following.



Operation

1. Deactivate AUTO HOLD and release the parking brake when the vehicle is in ON position.
2. Depress the brake pedal.
3. Turn the shift dial to N (Neutral).
4. Take your foot off the brake pedal, and the message will appear on the instrument cluster.
5. Press and hold the OK button on the steering wheel for more than 1 second.
6. Press the EV button after the message appears on the instrument cluster.

* INFORMATION

However, if you open the driver's door within 3 minutes in ACC position, the gear will automatically shift to P (Park) and the vehicle will change to OFF position.

* NOTICE

With the gear in N (Neutral), the vehicle will be in the ACC position. Note that the doors cannot be locked in ACC position or the battery (12V) may discharge if left in the ACC position for a long period.

Shift-lock system

Shift-lock system prevents shifting the gear from P (Park) into N (Neutral)/R (Reverse)/D (Drive) or N (Neutral) into R (Reverse)/D (Drive) unless the brake pedal is depressed.

⚠ WARNING

- ALWAYS check the surrounding areas near your vehicle for people, especially children, before shifting a vehicle into D (Drive) or R (Reverse).
- Before leaving the driver's seat, always make sure the gear is in the P (Park) position, then set the parking brake, and place the Power button in the OFF position. Unexpected and sudden vehicle movement can occur if these precautions are not followed.
- Shifting into P (Park) while the vehicle is in motion may cause you to lose control of the vehicle.
- After the vehicle has stopped, always make sure P (Park) gear position is selected, apply the parking brake, and turn the vehicle off.
- Do not use the P (Park) position in place of the parking brake.

⚠ CAUTION

Always come to a complete stop before shifting into or out of R (Reverse); you may damage the reduction gear if you shift into R (Reverse) while the vehicle is in motion, except on "Rocking the vehicle" (refer to "Rocking the vehicle" on page 6-188).

*** NOTICE**

- Always depress the brake pedal while shifting to another gear.
 - You cannot shift the gear while the charging cable is connected.
-

LCD display messages

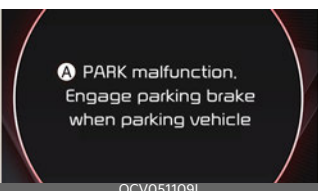
Message	Content
 <p>A Shifting conditions not met. Reduce speed, then shift</p> <p>OCV051105L</p>	<p>A: Shifting conditions not met. Reduce speed, then shift</p> <ul style="list-style-type: none"> When driving speed is too fast to shift the gear. When the gear is shifted while the vehicle is in Utility mode.
 <p>A Press brake pedal to change gear</p> <p>OCV051106L</p>	<p>A: Press brake pedal to change gear</p> <ul style="list-style-type: none"> When the brake pedal is not depressed while shifting the gear.
 <p>A Shift to P after stopping</p> <p>OCV051107L</p>	<p>A: Shift to P after stopping</p> <ul style="list-style-type: none"> When the gear is shifted to P (Park) while the vehicle is moving.
 <p>A Gear already selected</p> <p>OCV051108L</p>	<p>A: Gear already selected</p> <ul style="list-style-type: none"> When the selected gear button is pressed again.
 <p>A PARK malfunction. Engage parking brake when parking vehicle</p> <p>OCV051109L</p>	<p>A: PARK malfunction. Engage parking brake when parking vehicle</p> <ul style="list-style-type: none"> When there is a problem with function engaging P (Park) position.

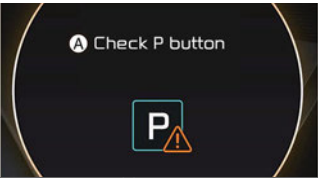
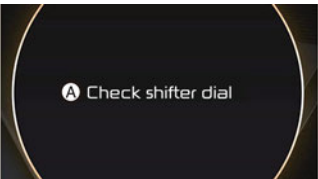
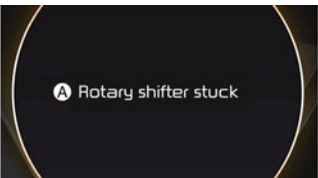
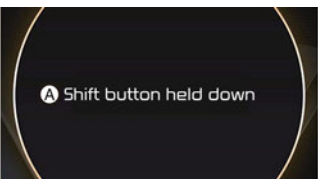
Message	Content
 <p data-bbox="273 376 356 392">OCV051110L</p>	<p data-bbox="542 272 676 293">A: Check P button</p> <ul data-bbox="542 296 851 319" style="list-style-type: none"> • When there is problem with the P button.
 <p data-bbox="273 584 356 600">OCV051111L</p>	<p data-bbox="542 480 687 501">A: Check shifter dial</p> <ul data-bbox="542 504 848 526" style="list-style-type: none"> • When there is problem with the shift dial.
 <p data-bbox="273 791 356 807">OCV051112L</p>	<p data-bbox="542 679 705 700">A: Rotary shifter stuck</p> <ul data-bbox="542 703 984 746" style="list-style-type: none"> • When the shifter dial is continuously stuck or there is problem with the shifter dial.
 <p data-bbox="273 999 356 1015">OCV051228L</p>	<p data-bbox="542 898 732 919">A: Shift button held down</p> <ul data-bbox="542 922 777 944" style="list-style-type: none"> • When the shift button is stuck.

Regenerative braking system

The regenerative braking system allows you to charge the battery when you use the brakes to stop the vehicle.

Adjusting regenerative braking with paddle shifter



- The regenerative braking system is activated in 100% charge.
- The vehicle is in **SNOW** mode.
- The trailer is installed.

Regenerative braking system according to DRIVE MODE

- Initial setting of the regenerative braking level and adjustable range vary according to the selected drive mode.
- The setting will return to 1 when the vehicle is restarted from 0.
- For more details, refer to "Drive mode integrated control system" on page 6-32.

Drive mode	Initial setting
SNOW	0-1
ECO	0-3
NORMAL	0-3
SPORT	0-3

One pedal driving

The driver can stop the vehicle by pulling and holding the left side paddle shifter.

Operation

- Pull the left side (+) of the paddle shifter to increase regenerative braking and deceleration.
- Pull the right side (-) of the paddle shifter to decrease regenerative braking and deceleration.

Non-operating condition(s)

- The left side (+) and right side (-) of paddle shifters are pulled simultaneously.
- Decelerating the vehicle by depressing the brake pedal.
- Cruise Control or Smart Cruise Control is operating.

Operation

- Pull and hold the left side (+) of the paddle shifter while coasting.
- When the vehicle speed is above 3 km/h (1 mph), regenerative braking level will return to the previously set level when the paddle shifter is released.
- When the vehicle speed is below 3 km/h (1 mph), the vehicle stopping control will be maintained when the paddle shifter is released.
- While one pedal driving function is operating, the driver can control the

vehicle stopping position by accelerator pedal.

Operating condition(s)

- The driver's door is closed.
- EPB is automatically activated when:
 - The driver's door is opened.
 - Seat belt is not fastened
 - The hood is opened.
 - The tailgate is opened.
 - Vehicle stops for more than approximately 5 minutes
 - At the request of other systems.

i-Pedal

i-Pedal is controlled by acceleration pedal. It provides vehicle speed control without manually controlling the paddle shifter.

Operation

1. Pull the left side (+) of the paddle shifter to level 3 regenerative braking system.
2. Pull the left side of the paddle shifter once again when the regenerative braking level reaches level 3.
 - Check i-Pedal indicator symbol **i-Pedal** on the instrument cluster.

WARNING

- Do not solely rely on one pedal driving to stop the vehicle. Stopping the vehicle may not be possible depending vehicle and road conditions. Pay attention to the road condition ahead and apply the brake if necessary.
- Avoid increasing the regenerative braking level suddenly on slippery roads (like snow or icy conditions) because it may lead slipping of the tires and skidding of vehicle. It can be dangerous due to the loss of the vehicle's steering force.

CAUTION

When the vehicle is stopped or parked by i-Pedal on the steep hills, be sure to depress the brake pedal.

Smart regeneration system

The Smart Regeneration System controls the regenerative braking automatically according to the road gradient and driving condition of the vehicle in front.

The system minimizes the unnecessary operation of the brake and acceleration pedal, improving the electric efficiency and assisting the driver.

Operating smart regeneration system

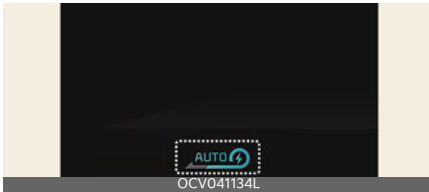

Operation

1. Select **Settings** → **ECO Vehicle** → **Smart Recuperation** → **Faster deceleration/Normal deceleration/Slow deceleration** on the infotainment system.
2. Pull and hold the right side (↶) of the paddle shifter for more than approximately 1 second.
 - **AUTO** symbol will be displayed on the cluster.
 - The regenerative braking level can be adjusted based on the driver's deceleration style.

Operating condition(s)

- When the vehicle speed is above approximately 10 km/h (6 mph)
- The road gradient changes
- Distance from the vehicle ahead reduces or increases

- Speed of the vehicle ahead reduces or increases

Detecting sensor

Front radar



Always make sure the radar sensor cover is clean and free of dirt, snow, and debris.

Dirt, snow, or foreign substances on the lens may adversely affect the sensing performance of the sensor. In this case, the system operation may stop temporarily and not operate normally.

Temporarily canceling smart regeneration system

Operating condition(s)

- The vehicle is shifted to N (Neutral), R (Reverse) or P (Park).
- Cruise Control or Smart Cruise Control is operating.
- ESC (Electronic Stability Control) or ABS is operating.

Setting default smart regeneration system level

Operation

- Pull the paddle shifter when the smart regeneration system is ON. The level adjustment by smart regeneration system will operate above set level.

Resuming smart regeneration system

Operation

- Pull and hold the right side of the paddle shifter for more than approximately 1 second again.

Turning smart regeneration system off

Operation

- Pull and hold the right side of the paddle shifter for more than approximately 1 second.

Smart regeneration system malfunction and limitations

Smart regeneration system malfunction



OCV05114L

A: Check Smart Regeneration System

The message will appear when the system is not functioning normally. The system will be canceled and the word **AUTO** on the cluster will disappear and instead display regenerative braking level. Check for foreign substances on the front radar. Remove any dirt, snow, or foreign material that could interfere with the radar sensors. If the system still does not operate normally, have the vehicle inspected by a professional workshop. Kia recommends visiting an authorized Kia dealer/service partner.

Limitations of smart regeneration system

Driving on a curved road



OCV051006L

When driving on the curve, the system may not detect the vehicle in your lane and the regenerative braking level will reduce automatically, making you feel that the vehicle is accelerating.

Also, if the system suddenly recognizes the vehicle in front, the regenerative braking level will increase automatically, making you feel that the vehicle is decelerating.

The driver must maintain a safe braking distance, and if necessary, depress the brake pedal to reduce your driving speed in order to maintain a safe distance.



OCV051007L

The smart regeneration system may recognize a vehicle in an adjacent lane when driving on a curved road. In this case, the system increase the braking level and slow the vehicle.

Always pay attention to road and driving conditions while driving. If necessary, depress the brake pedal to reduce your driving speed in order to maintain a safe distance. Also, when necessary, you may

depress the accelerator pedal to prevent the system from unnecessarily decelerating your vehicle.

Always check the traffic conditions around the vehicle.

Driving on a sloped road



When driving on an uphill or downhill, the system may not detect the vehicle in your lane and the regenerative braking level will reduce automatically, making you feel that the vehicle is accelerating. Also, if the system suddenly recognizes the vehicle in front, the regenerative braking level will increase automatically, making you feel that the vehicle is decelerating.

The driver must maintain a safe braking distance, and if necessary, depress the brake pedal to reduce your driving speed in order to maintain a safe distance.

Changing lanes

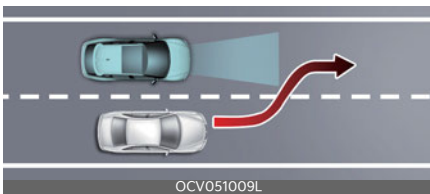

When a vehicle changes lanes in front of you, the smart regeneration system may not immediately detect the vehicle, especially if the vehicle changes lanes abruptly. In this case, you must maintain

a safe braking distance, and if necessary, depress the brake pedal to reduce your driving speed in order to maintain a safe distance.

Recognizing the vehicle



Some vehicles in your lane cannot be recognized by the sensor:

- Narrow vehicles such as motorcycles or bicycles
- Vehicles offset to one side
- Slow-moving vehicles or sudden-decelerating vehicles
- Stopped vehicles (When the vehicle ahead drives away, the system may not detect a stopped vehicle.)
- Vehicles with small rear profile such as trailers with no loads

A vehicle ahead cannot be recognized correctly by the sensor if any of following occurs:

- When the vehicle is pointing upwards due to overloading in the luggage compartment
- While the steering wheel is operating
- When driving to one side of the lane
- When driving on narrow lanes or on curves

Apply the brake or accelerator pedal if necessary.

WARNING

- When vehicle speed is under 10 km/h (6 mph), the Smart Regeneration System is canceled. The driver must adjust the vehicle speed by depressing the accelerator or brake pedal according to the road condition ahead and driving condition.
 - Smart Regeneration System relies on front view camera in the vehicle. Foreign substances on the front view camera may cause the malfunction of Smart Recuperation System. Be sure to maintain clear view for the front view camera.
 - The Smart Regeneration System will not operate when the Forward Collision- Avoidance Assist (FCA) warning light on the cluster is illuminated. The driver must adjust the vehicle speed by depressing the accelerator or brake pedal according to the road condition ahead and driving condition.
 - The Smart Regeneration System which automatically controls the regenerative braking level when coasting is only a supplemental system for the driver's convenience. Do not solely rely on this system to stop the vehicle. The system cannot completely stop the vehicle in all situations nor avoid all collisions. The brake control may be insufficient depending on the speed of the vehicle in front and when the vehicle in front suddenly stops, a vehicle cuts in suddenly and there is a steep slope. Always look ahead cautiously to prevent unexpected and sudden situations from occurring.
- When the Smart Regeneration System is canceled automatically, adjust the vehicle speed directly by depressing the accelerator or brake pedal according to the road and driving conditions ahead.
 - When using the Smart Regeneration System take the following precautions:
 - If an emergency stop is necessary, you must apply the brakes.
 - Keep a safe distance according to road conditions and vehicle speed. If the vehicle to vehicle distance is too close during a high-speed driving, a serious collision may result.
 - Always maintain sufficient braking distance and decelerate your vehicle by applying the brakes if necessary.
 - The Smart Regeneration System is designed to detect and monitor the vehicle ahead in the roadway through radar signals. It is not designed to detect oncoming vehicles, pedestrians, bicycles, motorcycles, or smaller wheeled objects such as luggage bags, shopping carts, or strollers.
 - Vehicles moving in front of you with a frequent lane change may cause a delay in the system's reaction or may cause the system to react to a vehicle actually in an adjacent lane. Always drive cautiously to prevent unexpected and sudden situations from occurring.
 - The Smart Regeneration System may not recognize complex driving situations so always pay attention to driving conditions and control your vehicle speed.
-

⚠ CAUTION

- Do not apply license plate frame or foreign objects such as a bumper sticker or a bumper guard near the radar sensor. Doing so may adversely affect the sensing performance of the radar.
 - Always keep the radar sensor and lens cover clean and free of dirt and debris.
 - Use only a soft cloth to wash the vehicle. Do not spray pressurized water directly on the sensor or sensor cover.
 - Be careful not to apply unnecessary force on the radar sensor or sensor cover. If the sensor is forcibly moved out of proper alignment, the Smart Regeneration System may not operate correctly. In this case, a warning message may not be displayed. Have the vehicle inspected by a professional workshop. Kia recommends visiting an authorized Kia dealer/service partner.
 - If the front bumper becomes damaged in the area around the radar sensor, the Smart Regeneration System may not operate properly. Have the vehicle inspected by a professional workshop. Kia recommends visiting an authorized Kia dealer/service partner.
 - Use only genuine Kia parts to repair or replace a damaged sensor or sensor cover. Do not apply paint to the sensor cover.
-

*** NOTICE**

The Smart Regeneration System may not operate temporarily due to:

- Electrical interference
 - Modifying the suspension
 - Differences of tire abrasion or tire pressure
 - Installing different type of tires
-

Brake system

In the event of brake failure

Operation

- Make an emergency stop with the parking brake.

Operating condition(s)

- The brake has failed

Power-assisted brakes

Operation

- Apply greater force to the brake pedal.

Operating condition(s)

- The vehicle is stalled

Brake over accelerator

Operation

1. Apply the brakes steady and firmly.
2. Stop the vehicle safely.
3. Shift to P. Turn off the vehicle and apply the parking brake.
4. Inspect the accelerator pedal for any interference.

Operating condition(s)

- The accelerator pedal is stuck

Disc brakes wear indicator

The front or rear brakes will squeal when the brake pads are worn. Always replace the front or rear brake pads as pairs.

Brake disc cleaning

If there is a surface rust on the brake disc or squeal can be heard, select level 0 of the regenerative brake system.

The regenerative brake system will be temporarily deactivated to clean the brake disc.

WARNING

- Avoid applying the parking brake to stop the vehicle while it is moving except in an emergency situation. Applying the parking brake while the vehicle is moving at normal speeds can cause a sudden loss of control of the vehicle. If you must use the parking brake to stop the vehicle, use great caution in applying the brake.
- Avoid continuous application of the brakes when descending a long or steep hill. Continuous brake application will cause the brakes to overheat and could result in a temporary loss of braking performance.
- Do not ignore high pitched wear sounds from your brakes. If you ignore this audible warning, you will eventually lose braking performance, which could lead to a serious accident.

CAUTION

- Do not drive with your foot resting on the brake pedal. This will create abnormally high brake temperatures which can cause excessive brake lining and pad wear.
- Do not continue to drive with worn brake pads. Continuing to drive with worn brake pads can damage the braking system and result in costly brake repairs.

* NOTICE

- Do not continue depressing the brake pedal if the **READY** indicator is OFF. The battery may be discharged.
- Noise and vibration generated during braking is normal.
- Under normal operation, electric brake pump noise and motor vibration may occur temporarily in below cases.
 - When the pedal is depressed suddenly.
 - When the pedal is repeatedly depressed in short intervals.
 - When the ABS function is activated while braking.
- If none are found and the condition persists, have your vehicle towed to a professional workshop and inspected. Kia recommends visiting an authorized Kia dealer/service partner.
- Brake dust may accumulate on the wheels, even under normal driving conditions. Some dust is inevitable as the brakes wear and contribute to brake noise.
- The driving efficiency could decrease due to regenerative system deactivated.
- When stepping on the brake pedal under a certain driving or weather condition, you may witness your car make a sound of squealing or some other noises. This is not a brake malfunction but a normal phenomenon.
- When driving on the road to which deicing chemicals are applied, the vehicle may witness noises from the brake or abnormal abrasion of tires because of such deicing chemicals. You should operate brake additionally so that you would be able to remove

the deicing chemicals on the brake disk and pad under a safe traffic condition.

Parking brake

Check if the brake warning light (ⓘ) illuminates when the vehicle is in the START or ON position. Be sure the parking brake is fully released and the brake warning light (ⓘ) is off before driving.

⚠ WARNING

- To reduce the risk of **SERIOUS INJURY** or **DEATH**, do not operate the parking brake while the vehicle is moving except in an emergency situation. It could damage the brake system and lead to an accident.
- Whenever leaving the vehicle or parking, always come to a complete stop and continue to depress the brake pedal. Make sure the gear is shifted to P (Park) position, then apply the parking brake, and set the EV button to OFF position. Vehicles with the parking brake not fully engaged are at risk for moving inadvertently and causing injury to yourself or others.
- NEVER allow anyone who is unfamiliar with the vehicle to touch the parking brake. If the parking brake is released unintentionally, serious injury may occur.
- Only release the parking brake when you are seated inside the vehicle with your foot firmly on the brake pedal.
- Never allow a passenger to touch the parking brake. If the parking brake is released unintentionally, serious injury may occur.

* NOTICE

- Do not apply the accelerator pedal while the parking brake is engaged. If you depress the accelerator pedal with the parking brake engaged, warning will sound. Damage to the parking brake may occur.
- Driving with the parking brake on can overheat the braking system and cause premature wear or damage to brake parts. Make sure the parking brake is released and the brake warning light is off before driving.

Electronic Parking Brake EPB

Applying the EPB manually



Operation

- Depress the brake pedal and pull the EPB switch up to apply the parking brake.

⚠ WARNING

- Risk of accident and injury due to children left unattended in the vehicle. If you leave children unaccompanied in the vehicle, they may be able to set the vehicle in motion, for example by:
 - Releasing the parking brake.
 - Shifting the gear out of P (Park) position.
 - Starting the vehicle. In addition, they may operate vehicle equipment.

- Never leave children and animals unattended in the vehicle.
- When leaving the vehicle, always take the smart key with you and lock the vehicle.

* NOTICE

- On a steep incline or when pulling a trailer, if the vehicle does not remain at a standstill, do as follows:
 - Apply the EPB.
 - Pull up the EPB switch for more than 3 seconds.
- A click or electric brake motor whine sound may be heard while operating or releasing the EPB. These conditions are normal and indicate that the EPB is functioning properly.

Applying the EPB automatically

Operating condition(s)

- Shifting to P on a slope
- Vehicle in OFF position with AUTO HOLD enabled
- When the vehicle moves a bit in P
- At the request of other systems.
- The conditions below apply when Auto Hold is enabled:
 - The driver's door is opened.
 - The hood is opened.
 - The tailgate is opened.
 - The vehicle stops for more than approximately 10 minutes on a steep slope
 - At the request of other systems.

* NOTICE

For Electronic Parking Brake **EPB** equipped vehicles with AUTO HOLD function used while driving, if the EV

button is in OFF position, the EPB will be engaged automatically. Therefore, AUTO HOLD function should be turned off before the EV button is in OFF position.

Releasing EPB manually

Operation

- Depress the brake pedal. Make sure the gear is in P and push the EPB switch down to release the parking brake.

Releasing EPB automatically

Operation

1. Start the vehicle.
2. Fasten the driver's seat belt.
3. Close the driver's door, hood and tailgate.
4. When the vehicle is ON, depress the brake pedal and shift to R or D.
5. Depress the accelerator pedal while the gear is in R, D or manual mode.

⚠ CAUTION

Do not drive your vehicle with the EPB applied. It may cause excessive brake pad and brake rotor wear.

* NOTICE

- For the Middle East, EPB is released regardless of seat belt fastening.
- Do not follow these procedures when driving on a flat level ground. The vehicle may suddenly move forward:
 - For your safety, depress the brake pedal and release the parking brake manually with the EPB switch when you drive downhill or when Reversing the vehicle.

- For your safety, you can engage the EPB even though the vehicle is in the OFF position, but you cannot release it.
- If the parking brake warning light is still on even though the EPB has been released, have the system checked by a professional workshop. Kia recommends visiting an authorized Kia dealer/service partner.

EPB warning message

Operating condition(s)

- Attempting to drive off using the accelerator pedal with the EPB applied
- Driver's seat belt is not fastened and the vehicle hood, driver's door or the tailgate is opened.
- There is a problem with the vehicle
- Conversion from AUTO HOLD to EPB is not working properly
- EPB is applied while AUTO HOLD is activated due to Electronic Stability Control (ESC) signal

EPB malfunction indicator

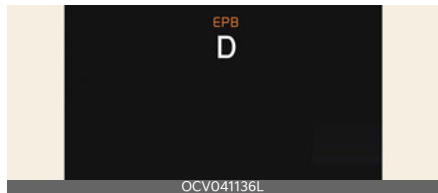

If the EPB malfunction indicator remains on, turns on while driving, or does not turn on when the vehicle is in the ON position, this indicates that the EPB may be malfunctioning.

Have your vehicle checked by a professional workshop as soon as possible. Kia

recommends to visit an authorized Kia dealer/service partner.

* NOTICE

- The EPB warning light may illuminate if the EPB switch operates abnormally. Shut the vehicle off and turn it on again after a few minutes. The warning light will go off and the EPB switch will operate normally. However, if the EPB warning light is still on, have the system checked by a professional workshop. Kia recommends to visit an authorized Kia dealer/service partner.
- If the parking brake warning light does not illuminate or blinks even though the EPB switch was pulled up, the EPB is not applied.
- If the parking brake warning light blinks when the EPB warning light is on, press the EPB switch, then pull it up. Once more press it back to its original position and pull it back up. If the EPB warning does not go off, have the system checked by a professional workshop. Kia recommends to visit an authorized Kia dealer/service partner.

Emergency braking with the EPB switch

Operation

- Pull and hold the EPB switch up to engage the emergency brake.

⚠ WARNING

Do not operate the Electronic Parking Brake **EPB** while the vehicle is moving except in an emergency situation. Applying the EPB while the vehicle is moving at normal speeds can cause a sudden loss of control of the vehicle. If you must

use the EPB to stop the vehicle, use great caution in applying the brake.

* NOTICE

During emergency braking by the EPB, the parking brake warning light will illuminate to indicate that the system is operating.

When the EPB does not release properly

Operation

1. Load the vehicle on a flatbed tow truck.
2. Take your vehicle to a professional workshop to check the system. Kia recommends visiting an authorized Kia dealer/service partner.

⚠ WARNING

Do not operate the Electronic Parking Brake **EPB** while the vehicle is moving except in an emergency situation. Applying the EPB while the vehicle is moving at normal speeds can cause a sudden loss of control of the vehicle. If you must use the EPB to stop the vehicle, use great caution in applying the brake.

* NOTICE

During emergency braking by the EPB, the parking brake warning light will illuminate to indicate that the system is operating.

AUTO HOLD

The AUTO HOLD maintains the vehicle in a stopped position without depressing the brake pedal.

Applying AUTO HOLD



Operation

1. Press the AUTO HOLD button. The AUTO HOLD indicator will light up in white.
2. The AUTO HOLD indicator changes from white to green when the vehicle is stopped.
3. AUTO HOLD will be released automatically when the accelerator pedal is pressed in D, R, or manual mode. The AUTO HOLD indicator will change from green to white.
4. Press the AUTO HOLD button again while pressing the brake pedal to cancel the AUTO HOLD operation.



Operating condition(s)

- Brake pedal is depressed after the vehicle has started.

Non-operating condition(s)

- P (Park) gear position is selected.

- The EPB is applied.

AUTO HOLD warning messages

Operating condition(s)

- When the EPB is automatically applied from AUTO HOLD
- AUTO HOLD to EPB conversion is not working properly
- Brake pedal is not applied when the AUTO HOLD button is pressed

* INFORMATION

If the vehicle is restarted with the AUTO HOLD button pressed, AUTO HOLD will be in the standby state.

⚠ WARNING

To reduce the risk of an accident, do not activate AUTO HOLD while driving downhill, Reversing or parking your vehicle.

* NOTICE

- If the AUTO HOLD indicator lights up yellow, the AUTO HOLD is not working properly. Take your vehicle to a professional workshop and have the system checked. Kia recommends visiting an authorized Kia dealer/service partner.
- A click or electric brake motor whine sound may be heard while operating or releasing the EPB, but these conditions are normal and indicate that the EPB is functioning properly.
- If the vehicle is restarted with the Auto Hold system is in the standby position or operating, the Auto hold system will continue to operate in the standby position.

Vehicle safety system

Anti-lock Brake System (ABS)

The Anti-lock Brake System (ABS) prevents the wheels from locking up in order to steer and stabilize the vehicle. If the ABS warning light (🚗) stays on, contact a professional workshop as soon as possible. Kia recommends visiting an authorized Kia dealer/service partner.

* NOTICE

- A click sound may be heard in the vehicle compartment when the vehicle begins to move after the vehicle is started. These conditions are normal and indicate that the Anti-lock Brake System is functioning properly.
- When you jump start your vehicle because of a drained battery, the vehicle may not run as smoothly and the ABS warning light may turn on at the same time. This happens because of low battery voltage. It does not mean your ABS has malfunctioned.
 - Do not pump your brakes!
 - Have the battery recharged before driving the vehicle.

Electronic Stability Control (ESC)

Electronic Stability Control (ESC) is designed to stabilize the vehicle during cornering maneuvers.

ESC is not a substitute for safe driving practices. Factors such as speed, road conditions, and driver steering input can all affect whether ESC will be effective in preventing loss of control.

Operating ESC

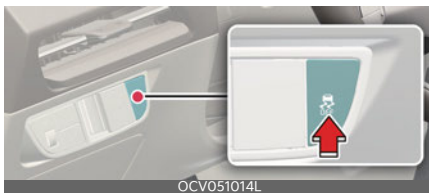

Operation

- Press the ESC OFF button for approximately half a second to turn ESC off. ESC OFF (🚗) indicator light will illuminate and the warning chime will sound.
- Press and hold the ESC OFF button again for approximately 3 seconds to turn ESC and traction control off. ESC OFF (🚗) indicator light will illuminate and the warning chime will sound.
- To turn ESC on again, press the ESC OFF button. ESC OFF (🚗) indicator light will go off.

⚠ WARNING

- For maximum protection, always wear your seat belt. No system, no matter how advanced, can compensate for all driver error and/or driving conditions. Always drive responsibly.
- Drive carefully even though your vehicle has Electronic Stability Control. It can only assist you in maintaining control under certain circumstances.
- When ESC (electric vehicle control) is deactivated, the vehicle will lose the traction and stability if the vehicle is driven by abrupt steering wheel control. It is possible that the tire may make a collision with the connected parts of the tire. We recommend to do not turn off ESC while driving the vehicle for your safety.

* NOTICE

- A click sound may be heard in the vehicle compartment when the vehicle begins to move after the vehicle is started. These conditions are normal and indicate that the Electronic Stability Control system is functioning properly.
- When operating the vehicle on a dynamometer, ensure that the ESC is turned off (ESC OFF light illuminated). If the ESC is left on, it may prevent the vehicle speed from increasing, and result in false diagnosis.
- Turning the ESC off does not affect ABS or brake system operation.
- Select 0 step of the regenerative braking system and depress the brake pedal around 10 times to efficiently apply brake disc cleaning. Brake disc cleaning may decrease.
- Brake disc cleaning may decrease the driving distance by restraining the regenerative braking system. After brake disc cleaning, the regenerative braking system may be restored.
- If the regenerative braking system is not restored after the brake disc cleaning, Kia recommends visiting an authorized Kia dealer/service partner.

Hill-start Assist Control (HAC)

Hill-start Assist Control (HAC) prevents the vehicle from rolling back by applying the brakes automatically for approximately 2 seconds (maximum of 5 seconds when the accelerator pedal is slightly depressed during HAC operation).

The brakes are released when the accelerator pedal is engaged or after approximately 2 seconds.

⚠ WARNING

HAC does not replace the need to apply brakes while stopped on an incline. While stopped, make sure you maintain brake pressure sufficient to prevent your vehicle from rolling backward and causing an accident. Don't release the brake pedal until you are ready to accelerate forward.

Multi-Collision Brake (MCB)

Multi-Collision Brake controls the brake automatically in the event of an accident where the air bag deploys to reduce the risk of additional accidents that may occur.

System operation

- From the time the air bag deploys, Multi-Collision Brake monitors the depression intensity of the brake pedal and accelerator pedal for a short period. The system operates when the following conditions are met:
 - Vehicle speed is under 180 km/h (112 mph) at the time of collision.
 - The brake pedal and accelerator pedal are pressed only slightly .
- When the driver steps on the brake pedal over a certain level while Multi-Collision Brake is active, the braking power takes priority over automatic braking by Multi-Collision Brake system. However, if the driver takes his/her foot off the brake pedal, Multi-Collision Brake system will maintain automatic braking.

System off

- Multi-Collision Brake is canceled in the following situations:
 - The accelerator pedal is depressed over a certain level.
 - The vehicle stops.
 - ESC (Electronic Stability Control) or electronic devices has malfunctioned.
 - In a situation system cannot operate normally.
 - Ten seconds have passed since the brake has been controlled automatically by Multi-Collision Brake system.

⚠ WARNING

- Multi-Collision Brake decreases vehicle speed after a collision and reduces the risk of a second collision, but it does not prevent a second collision. You may drive away from the collision spot to avoid other dangerous situations by depressing the accelerator pedal.
- After the vehicle is stopped by Multi Collision Brake, the system stops controlling the brakes.

Depending on the situation, the driver should depress the brake or the accelerator pedal to prevent a further accident.

Vehicle Stability Management (VSM)

Vehicle Stability Management (VSM) provides further enhancements to vehicle stability and steering response.

Operating VSM



Operation

- Press the ESC OFF button to turn VSM off and the ESC OFF indicator light (⚠) is illuminated.
- Press the ESC OFF button again to turn VSM on and the ESC OFF indicator light (⚠) will go off.

Operating condition(s)

- Driving on slippery roads
- Grip change of left and right wheels is detected

Non-operating condition(s)

- Driving on a gradient or inclined surface
- Driving in reverse.
- ESC OFF indicator light (⚠) remains illuminated
- EPS warning light (⚠) remains illuminated

VSM malfunction indicator

VSM can be deactivated when a malfunction has been detected in the Electronic Power Steering system or VSM system. If the ESC indicator light (🚗) or EPS warning light (⚠️) remains on, take your vehicle to a professional workshop and have the system checked. Kia recommends visiting an authorized Kia dealer/service partner.

⚠️ WARNING

When replacing tires and wheels, make sure they are the same size as the original tires and wheels installed. Driving with varying tire or wheel sizes may diminish any supplemental safety benefits of the VSM system.

Emergency Stop Signal (ESS)

The Emergency Stop Signal (ESS) alerts the driver behind by flashing the brake lights when braking sharply and severely.

Operating condition(s)

- The vehicle suddenly stops.
- ABS is activated and the driving speed is over 55 km/h (34 mph).
- The hazard warning flasher automatically turns ON after blinking the brake lights when:
 - The driving speed is under 40 km/h (25 mph)
 - The ABS is deactivated
 - The sudden braking is over

- The hazard warning flasher turns OFF when:
 - The vehicle drives at a low speed for a certain period of time.

* NOTICE

The Emergency Stop Signal (ESS) system will not activate, when the hazard warning flashers are already on.

Brake Assist System (BAS)

The Brake Assistant System provides additional pressure when the brake pedal is momentarily and strongly depressed in a situation sudden braking is required while driving.

The Brake Assistant System reduces the time for ABS(Anti-Lock Brake System) control to enter and consequently reduces the braking distance, by providing additional pressure up to the point of ABS intervention.

BAS operation

- When the vehicle speed is more than 30 km/h (20 mph) and the ABS control is not entered.
- When the brake pedal is depressed strongly over a certain level.
- When the friction of the road surface is above a certain level.

BAS operation off

- The vehicle speed is below 10 km/h (6 mph).
- The brake pedal is depressed over a certain conditions.
- The friction of the road surface is below a certain level.

⚠ WARNING

The system may not operate depending on driver's driving habit, the degree to which the brake pedal is depressed and the road surface condition.

Drive mode integrated control system

DRIVE MODE

Selecting DRIVE MODE

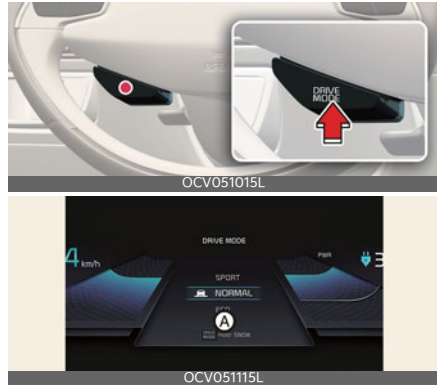

A: Hold

Operation

- Press the **DRIVE MODE** button.
- **DRIVE MODE** will change to **NORMAL** mode when the vehicle is restarted. **ECO** mode will be maintained when the vehicle is restarted.

Mode	Characteristics
SPORT	Provides sporty but firm riding
NORMAL	Driving on general roads, city center and highways
ECO	Improves electric energy efficiency for eco-friendly driving
SNOW	Provides safe driving on the snowy roads

DRIVE MODE characteristics for 4WD (if equipped)

DRIVE MODE button

DRIVE MODE	SNOW	NORMAL	ECO	SPORT
Characteristics	Snow driving	Normal driving mode	High electric energy efficiency mode	Sporty driving mode
Button activation	Press more than 1 second	Press	Press	Press
Cluster indicator	SNOW	NORMAL (Pop-up)	ECO	SPORT
Regenerative braking level	0~1	0~3		

Infotainment system

DRIVE MODE	SNOW	NORMAL	ECO	SPORT
Climate system control	NORMAL	NORMAL	ECO/NORMAL*	NORMAL
Brake mode	NORMAL	NORMAL/SPORT*	NORMAL	NORMAL/SPORT*

* NOTICE

- If there is a problem with the instrument cluster, the drive mode will be in **NORMAL** mode and may not change to **ECO** mode or **SPORT** mode.
- Efficiency depends on the driver's driving habit and road condition.
- In **SPORT** mode, the electric energy efficiency may decrease.
- When you mildly drive the vehicle in **NORMAL** mode, the driving mode changes to **ECO** mode to improve electric energy efficiency. However, the actual efficiency may differ in accordance with your driving situations.

* INFORMATION

It is possible to set the climate system control and brake mode separately. Select **Settings** → **Vehicle** → **Drive mode** → **Brake mode** or **ECO mode climate control** from the infotainment system.

For more information, refer to Navigation Quick Reference Guide.

All wheel drive (4WD) (if equipped)

When All Wheel Drive (4WD) is activated, driving forces are distributed appropriately to front and rear wheels. It could improve driving performance by maximizing the driving force of vehicles on severe road conditions such as steep hills, unpaved, slippery, etc.

Advantage of electronic 4WD

- Improvement of straight stability
- Improvement of driving performance on curve
- Secure stability on severe condition such as wet and sandy roads.
- Improvement of energy efficiency from driving mode automatic control.

For safe 4WD operation

Before driving

- Make sure all passengers are wearing seat belts.
- Sit upright and closer to the steering wheel than usual. Adjust the steering wheel to a position comfortable for you to drive.

Driving on snow-covered or icy roads

- Start off slowly by applying the accelerator pedal gently
- Use snow tires or tire chains.
- Keep sufficient distance between your vehicle and the vehicle in front of you.
- Using the regenerative braking helps the steering on the downhill. However it is difficult to adjust the vehicle while coasting, so avoid using the third level

of regenerative braking as much as possible.

- Avoid speeding, rapid acceleration, sudden brake applications, and sharp turns to prevent skids.
- It is difficult to start again if the vehicle stops on an uphill road. Keep your distance from other vehicles and drive slowly.

Driving in sand or mud

- Maintain a slow, constant speed.
- Use tire chains driving in mud if necessary.
- Keep sufficient distance between your vehicle and the vehicle in front of you.
- Reduce vehicle speed and always check the road condition.
- Avoid speeding, rapid acceleration, sudden brake applications, and sharp turns to prevent getting stuck.

Driving up or down hills

- Driving uphill
 - Before starting off, check if it is possible to drive uphill.
- Driving downhill
 - Drive straight as possible.



Driving through water

- Try to avoid driving in deep standing water.
- If you need to drive in water, stop your vehicle, set the vehicle in Multi Terrain mode and drive under 8 km/h (5 mph).
- Do not change gear while driving in water.

Additional driving conditions

- Become familiar with the off-road conditions before driving.
- Always pay attention when driving off-road and avoid dangerous areas.
- Drive slowly when driving in heavy wind.
- Reduce vehicle speed when cornering. The center of gravity of 4WD vehicles is higher than conventional 2WD vehicles, making them more likely to roll over when you rapidly turn corners.
- Always hold the steering wheel firmly when you are driving off-road.

WARNING

- If the 4WD warning light () stays on the instrument cluster, your vehicle may have a malfunction with the 4WD system. When the 4WD warning light () illuminates, have your vehicle checked by a professional workshop. Kia recommends visiting an authorized Kia dealer/service partner.
- Do not drive in conditions that exceed the vehicles intended design such as challenging off-road conditions.
- Avoid high speeds when cornering or turning.
- Do not make quick steering wheel movements, such as sharp lane changes or fast, sharp turns.
- The risk of a rollover is greatly increased if you lose control of your vehicle at highway speeds.
- Loss of control often occurs if two or more wheels drop off the roadway and the driver over steers to reenter the roadway.

- In the event your vehicle leaves the roadway, do not steer sharply. Instead, slow down before pulling back into the travel lanes.
- Exercise extreme caution driving up or down steep hills. The vehicle may flip depending on the grade, terrain and water/mud conditions.
- Do not grab the inside of the steering wheel when you are driving off-road. You may hurt your arm by a sudden steering maneuver or from steering wheel rebound due to an impact with objects on the ground. You could lose control of the steering wheel which may lead to serious injury or death.

CAUTION

Always drive slowly in water. If you drive too fast, water may get into the motor compartment, causing your vehicle to suddenly stop.

NOTICE

- Do not drive in water if the level is higher than the bottom of the vehicle.
- Check your brake condition once you are out of mud or water. Depress the brake pedal several times as you move slowly until you feel normal braking return.
- Shorten your scheduled maintenance interval if you drive in offroad conditions such as sand, mud or water (refer to "Scheduled maintenance service" on page 8-6.)
- Make sure that 4WD vehicle is towed by a flatbed tow truck.

- 4WD vehicles could change the engagement status of the motor according to the situation required. Auto changing the driving mode (2WD/4WD) helps improve energy efficiency and driving stability.
- When the vehicle is stuck in snow, sand or mud, place a non-slip material under the drive wheels to provide traction OR slowly spin the wheels in forward and reverse directions which causes a rocking motion that may free the vehicle.
- When putting the tire chains to the tire, be sure to attach the chain to the two rear wheels. In this case, drive below 30 km/h (20 mph) and minimize the driving distance. High-speed or long-term driving with putting the tire chains may cause malfunction or damage to the four-wheel drive.
- If tire chains must be used, use fabric snow chain and install the tire chain after reviewing the instructions provided with the tire chains. For more information on Snow Tires and Tire Chains, refer to "Winter driving" on page 6-190.

Emergency precautions

Tires

When replacing the tires, be sure to equip all four tires with the tire and wheel of the same size, type, tread, brand and load-carrying capacity.

In case of emergency such as tire puncture, repair it using TMK (Tire Mobility Kit) for temporary use. Afterwards, have the tire be inspected by an authorized Kia dealer/service partner.

Towing

4WD vehicles must be towed with a wheel lift and dollies or flatbed equipment with all the wheels off the ground. For more information, refer to "Towing" on page 7-14.

Vehicle inspection

- When the vehicle is on a car lift, do not operate the front and rear wheels separately. All four wheels should be operated.
- Never engage the parking brake while running the vehicle on a car lift. This may damage the 4WD system.

Dynamometer testing

A 4WD vehicle must be tested on a special four wheel chassis dynamometer.

If a 2WD roll tester must be used, perform the following procedure.



- A: Roll tester (Speedometer)
- B: Temporary free roller

Operation

1. Check the tire pressures recommended for your vehicle.
2. Place the rear wheels on the roll tester for a speedometer test as shown in the illustration.
3. Release the parking brake.
4. Place the front wheels on the temporary free roller as shown in the illustration.

WARNING

- Do not use tire and wheel with different size and type from the one originally installed on your vehicle. It can affect the safety and performance of your vehicle, which could lead to steering failure or rollover causing serious injury.
- Never start or run the vehicle while a 4WD vehicle is raised on a jack. The vehicle can slip or roll off of a jack causing serious injury or death to you or those nearby.
- Keep away from the front of the vehicle while the vehicle is in gear on the dynamometer. The vehicle can jump forward and cause serious injury or death.

Active air flap

Active air flap system controls the air flap below the front bumper to cool the vehicle parts and improve energy efficiency.

Active air flap malfunction**A: Check the active air flap system**

The active air flap system may not operate normally if the air flap is temporarily opened due to foreign factors or if the controller is contaminated by snow or rain, etc.

When the message is popped up on the display, stop the vehicle in a safe place and check the status of the air flap.

Start the vehicle after performing the necessary work like foreign matter removal and waiting 10 minutes. If the pop-up remains up, have the vehicle inspected by a professional workshop. Kia recommends visiting an authorized Kia dealer/service partner.

⚠ CAUTION

- Regardless of the pop-up, if the air flaps aren't in the same position, stop the vehicle and wait for 10 minutes and start the vehicle and inspect the air flap.
- The active air flap system is actuated by motors. Do not disturb actuation or apply force excessively. It may cause failure.

*** NOTICE**

Active air flap system could be activate regardless of the vehicle condition.(Parking, driving, charging, etc.)

Forward Collision-Avoidance Assist (FCA) (if equipped)

Basic function



Forward Collision-Avoidance Assist is designed to help detect and monitor the vehicle ahead or help detect a pedestrian or cyclist in the roadway and warn the driver that a collision is imminent with a warning message and an audible warning, apply emergency braking.

In addition, if equipped with front corner radars, when driving at high speeds, Forward Collision-Avoidance Assist will help detect vehicles in front and adjacent lanes. If a collision is imminent when changing lanes, Forward Collision-Avoidance Assist will apply emergency braking to help prevent a collision.

Junction Turning function



Junction Turning function will help avoid a collision with an oncoming vehicle in an adjacent lane when turning left (left-hand drive) or right (right-hand drive) at a crossroad with the turn signal on by applying emergency braking.

Junction Crossing function (if equipped)

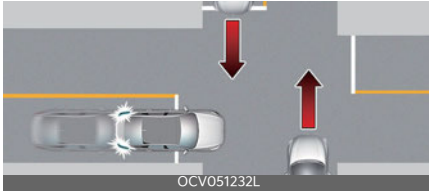

Junction Crossing function will help avoid a collision with oncoming vehicles on the left or right side when crossing an intersection by applying emergency braking.

Lane-Change Oncoming function (if equipped)

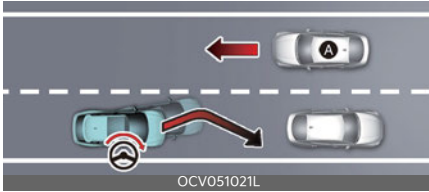

[A]: Oncoming vehicle

Lane-Change Oncoming function will help avoid a collision with an oncoming vehicle when changing lanes by assisting the driver's steering.

Lane-Change Side function (if equipped)



[A]: Front-side vehicle

Lane-Change Side function will help avoid a collision with the vehicle ahead

in the next lane when changing lanes by assisting the driver's steering.

Evasive Steering Assist function (if equipped)

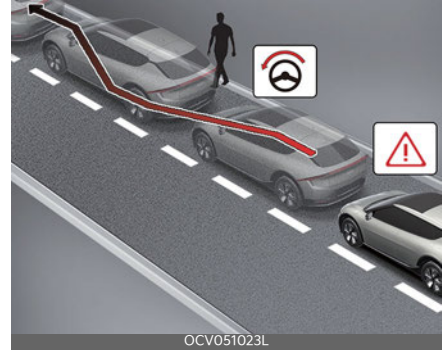

- Driver steering assist
Evasive Steering Assist function will help avoid a collision with a vehicle, pedestrian or cyclist ahead in the same lane. When a risk of collision is detected, Evasive Steering Assist function will warn the driver and if the driver steers to avoid collision it will assist the driver's steering.
- Evasive steering assist
Evasive Steering Assist function helps avoid a collision with a pedestrian or cyclist ahead in the same lane. When a risk of collision is detected, Evasive Steering Assist function will warn the driver and if there is space to avoid collision in the lane, it will assist the driver's steering.

Detecting sensor

Front view camera



Front radar



Front corner radar (if equipped)



Rear corner radar (if equipped)



Refer to the picture above for the detailed location of the detecting sensors.

⚠ CAUTION

Take the following precautions to maintain optimal performance of the detecting sensor:

- Never disassemble the detecting sensor or sensor assembly, or apply any impact on it.
- If the detecting sensors have been replaced or repaired, have the vehicle inspected by a professional workshop. Kia recommends visiting an authorized Kia dealer/service partner.
- Never install any accessories or stickers on the front windshield, or tint the front windshield.
- Pay extreme caution to keep the front view camera dry.
- Never place any reflective objects (i.e. white paper, mirror) over the dashboard.
- Do not apply license plate frame or objects, such as a bumper sticker, film or a bumper guard, near the front radar cover.
- Always keep the front radar and cover clean and free of dirt and debris. Use only a soft cloth to wash the vehicle. Do not spray pressurized water directly on the sensor or sensor cover.
- If unnecessary force has been applied to the radar or around the radar, Forward Collision-Avoidance Assist may not properly operate even though a warning message does not appear on the cluster. Have the vehicle inspected by a professional workshop. Kia recommends visiting an authorized Kia dealer/service partner.
- Use only genuine parts to repair or replace a damaged front radar cover. Do not apply paint to the front radar cover.

- Vehicles equipped with front corner radar and/or rear corner radar
 - Do not apply license plate frame or objects, such as a bumper sticker, film or a bumper guard, near the front corner radar or rear corner radar.
 - The function may not work properly when the bumper has been replaced, or the surroundings of the front corner radar or rear corner radar has been damaged or paint has been applied.
 - If a trailer, carrier, etc. is installed, it may adversely affect the performance of the rear corner radar or Forward Collision-Avoidance Assist may not operate properly.

Forward Collision-Avoidance Assist settings

Setting features

Forward Safety

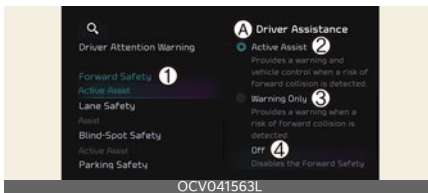

A: Driver assistance

- 1 Forward safety
- 2 Active assist
- 3 Warning only
- 4 Off

With the vehicle on, select **Settings** → **Vehicle** → **Driver assistance** → **Forward safety** from the infotainment system screen to set whether or not to use each function.

- **Active assist:** Forward Collision-Avoidance Assist will warn the driver with a warning message, an audible warning and steering wheel vibration depending on the collision risk levels. Braking assist or steering assist (if equipped) will be applied depending on the collision risk.
- **Warning only:** Forward Collision-Avoidance Assist will warn the driver with a warning message, an audible warning and steering wheel vibration depending on the collision risk levels. Braking and steering (if equipped) will not be assisted. The driver must apply the brake pedal or steer the vehicle if necessary.
- **Off:** Forward Collision-Avoidance Assist will turn off. The warning light (🚗) will illuminate on the cluster.

The driver can monitor Forward Collision-Avoidance Assist On/Off status from the Settings menu. If the warning light (🚗) remains On when Forward Collision-Avoidance Assist is On, have the vehicle inspected by a professional workshop. Kia recommends visiting an authorized Kia dealer/service partner.

Forward Cross-Traffic Safety (if equipped)

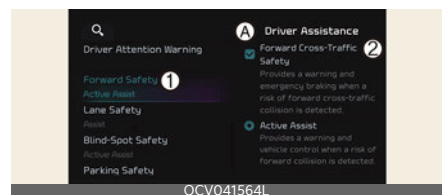

A: Driver assistance

- 1 Forward safety
- 2 Fwd. cross-traffic safety

With the vehicle on, select **Settings** → **Vehicle** → **Driver assistance** → **For-**

ward safety → **Fwd. cross-traffic safety** from the infotainment system screen to turn on Junction Crossing function and deselect to turn off the function.

⚠ WARNING

When the vehicle is restarted, Forward Collision-Avoidance Assist will always turn on. However, if **Off** is selected, the driver should always be aware of the surroundings and drive safely.

⚠ CAUTION

- If **Warning only** is selected, braking and steering (if equipped) is not assisted.
- The settings for Forward Safety include 'Basic function' and 'Junction Turning', 'Lane-Change Oncoming', 'Lane-Change Side' and 'Evasive Steering Assist' (if equipped).
- If Forward Safety is set to **Off**, Junction Crossing function will not operate even when **Fwd. cross-traffic safety** (if equipped) is selected.
- Steering wheel vibration can be turned on or off. Select or deselect **Settings** → **Vehicle** → **Driver assistance** → **Haptic warning** from the infotainment system screen.

*** NOTICE**

Forward Collision-Avoidance Assist will turn off when ESC is turned off by pressing and holding the ESC OFF button. The warning light (🚨) will illuminate on the cluster.

Warning timing

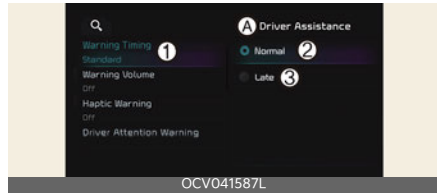

A: **Driver assistance**

- 1 Warning timing**
- 2 Normal**
- 3 Late**

With the vehicle on, select **Settings** → **Vehicle** → **Driver assistance** → **Warning timing** from the infotainment system screen to change the initial warning activation time for Forward Collision-Avoidance Assist.

- **Normal:** Use in a normal driving environment. If the function operates too sensitively, set to the warning timing to **Late**.
- **Late:** The warning timing will be slow

Warning volume

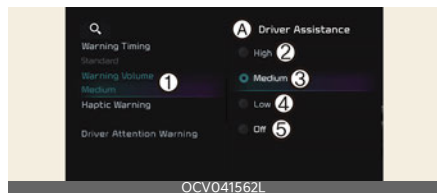

A: **Driver assistance**

- 1 Warning volume**
- 2 High**
- 3 Medium**
- 4 Low**
- 5 Off**

With the vehicle on, select **Settings** → **Vehicle** → **Driver assistance** → **Warning volume** from the infotainment system screen to change the Warning

Volume to **High, Medium, Low** or **Off** for Forward Collision-Avoidance Assist. However, even if **Off** is selected, the Warning Volume of Forward Collision Avoidance Assist will not turn off but the volume will sound as **Low**.

If you change the Warning Volume, the warning volume of other Driver Assistance systems may change.

⚠ CAUTION

- The setting of the Warning Timing and Warning Volume applies to all functions of Forward Collision-Avoidance Assist.
- Even though **Normal** is selected for Warning Timing, if the front vehicle suddenly stops, the initial warning activation time may seem late.
- Select **Late** for Warning Timing when traffic is light and when driving speed is slow.

* NOTICE

If the vehicle is restarted, Warning Timing and Warning Volume will maintain the last setting.

Forward Collision-Avoidance Assist operation

Basic function

Warning and control

The basic function for Forward Collision-Avoidance Assist is warned and controlled by the following level.

- Collision Warning
- Emergency Braking
- Stopping vehicle and ending brake control

Collision Warning



A: Collision Warning

The warning message, an audible warning and the steering wheel will vibrate to warn the driver of a collision.

Collision Warning will be activated in following conditions.

- Vehicle: Your vehicle speed is approximately 10~200 km/h (6~124 mph)
- Pedestrian or cyclist: Your vehicle speed is approximately 10~85 km/h (6~53 mph)

Emergency braking

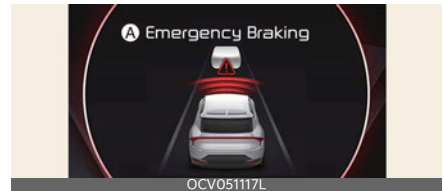

A: Emergency braking

The warning message, an audible warning and the steering wheel will vibrate to warn the driver that emergency braking will be assisted. The brake assist will be activated and it helps avoiding collision of a vehicle, pedestrian and cyclist.

Emergency Braking will be activated in following conditions depending on the target and the level of risk.

- Vehicle (weak braking): Your vehicle speed is approximately 10~85 km/h (6~53 mph)

- Vehicle (strong braking): Your vehicle speed is approximately 10~85 km/h (6~53 mph)
- If equipped with front corner radar, the function judges that avoiding a collision is difficult even by changing the driving lane, it will operate when your vehicle speed is between approximately 10~100 km/h (6~62 mph).
- The function operation range may decrease due to the front traffic condition or the surroundings of the vehicle.
- Pedestrian or cyclist: 10~65 km/h (6~40 mph)

Stopping vehicle and ending brake control



A: Drive carefully

When the vehicle is stopped due to emergency braking, the warning message will appear on the cluster.

For your safety, the driver should depress the brake pedal immediately and check the surroundings.

- Brake control will end after the vehicle is stopped by emergency braking for approximately 2 seconds.

Junction Turning function

Warning and control

The basic function for Junction Turning function is warned and controlled by the following level.

- Collision Warning

- Emergency Braking
- Stopping vehicle and ending brake control

Collision Warning



A: Collision Warning

The warning message, an audible warning and the steering wheel will vibrate to warn the driver of a collision.

Collision Warning will be activated in following conditions.

- Vehicle speed: Approximately 10~30 km/h (6~19 mph)
- Oncoming vehicle speed: Approximately 30~70 km/h (19~44 mph)

Emergency braking



A: Emergency braking

The warning message, an audible warning and the steering wheel will vibrate to warn the driver that emergency braking will be assisted. The brake assist will be activated and it helps avoiding collision of a vehicle.

Emergency Braking will be activated in following conditions.

- Vehicle speed: Approximately 10~30 km/h (6~19 mph)
- Oncoming vehicle speed: Approximately 30~70 km/h (19~44 mph)

*** NOTICE**

If the driver's seat is on the left side, Junction Turning function will operate only when the driver turns left. If the driver's seat position is on right side, the function will operate only when you turn right.

Stopping vehicle and ending brake control



A: Drive carefully

When the vehicle is stopped due to emergency braking, the warning message will appear on the cluster.

For your safety, the driver should depress the brake pedal immediately and check the surroundings.

- Brake control will end after the vehicle is stopped by emergency braking for approximately 2 seconds.

Junction Crossing function (if equipped)

Warning and control

The basic function for Junction Crossing function is warned and controlled by the following level.

- Collision Warning
- Emergency Braking
- Stopping vehicle and ending brake control

Collision Warning



A: Collision Warning

The warning message, an audible warning and the steering wheel will vibrate to warn the driver of a collision.

Collision Warning will be activated in following conditions.

- Vehicle speed: Approximately 10~30 km/h (6~19 mph)
- Crossing vehicle speed: Approximately 10~60 km/h (6~37 mph)

Emergency braking



A: Emergency braking

The warning message, an audible warning and the steering wheel will vibrate to warn the driver that emergency braking

will be assisted. The brake assist will be activated and it helps avoiding collision of a vehicle.

Emergency Braking will be activated in following conditions.

- Vehicle speed: Approximately 10~30 km/h (6~19 mph)
- Crossing vehicle speed: Approximately 10~20 km/h (6~12 mph)

Stopping vehicle and ending brake control

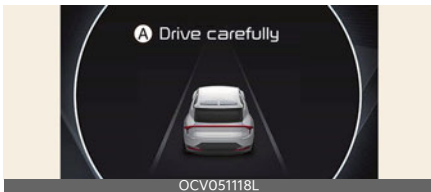

A: Drive carefully

When the vehicle is stopped due to emergency braking, the **Drive carefully** warning message will appear on the cluster.

For your safety, the driver should depress the brake pedal immediately and check the surroundings.

- Brake control will end after the vehicle is stopped by emergency braking for approximately 2 seconds.

CAUTION

If the collision angle with the crossing vehicle is beyond a certain range, Junction Crossing Warning and control may be late or may not operate.

Lane-Change Oncoming function (if equipped)

Warning and control

The basic function for Lane-Change Oncoming function is warned and controlled by the following level.

- Collision Warning
- Emergency Steering

Collision Warning



A: Collision Warning

The warning message, an audible warning and the steering wheel will vibrate to warn the driver of a collision.

Collision Warning will be activated in following conditions.

- Vehicle speed: Approximately 40~145 km/h (25~90 mph)
- Oncoming vehicle speed: Approximately above 10 km/h (6 mph)
- Relative speed: Approximately below 200 km/h (124 mph)

Emergency Steering

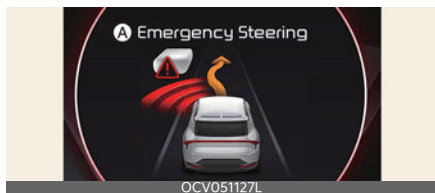

A: Emergency Steering

To warn the driver that emergency steering will be assisted, the warning message will appear on the cluster, an audible warning will sound and the steering wheel will vibrate.

Emergency Steering will be activated in following conditions.

- Vehicle speed: Approximately 40~145 km/h (25~90 mph)

- Oncoming vehicle speed: Approximately above 10 km/h (6 mph)
- Relative speed: Approximately below 200 km/h (124 mph)

Lane-Change Side function (if equipped)

Warning and control

The basic function for Lane-Change Oncoming function is warned and controlled by the following level.

- Collision Warning
- Emergency Steering

Collision Warning



A: Collision Warning

To warn the driver of a collision, the warning message will appear on the cluster, an audible warning will sound and the steering wheel will vibrate. Emergency Steering will be activated in following conditions.

- Vehicle speed: 40~145 km/h (25~90 mph)
- Front-side vehicle: Driving

Emergency Steering



A: Emergency Steering

To warn the driver that emergency steering will be assisted, the warning message will appear on the cluster, an audible warning will sound and the steering wheel will vibrate.

Emergency Steering will be activated in following conditions.

- Vehicle speed: Approximately 40~145 km/h (25~90 mph)

⚠ CAUTION

Lane-Change Side function does not operate if the oncoming vehicle from the front side is stopped.

Evasive Steering Assist function (if equipped)

Warning and control

The basic function for Lane-Change Oncoming function is warned and controlled by the following level.

- Emergency Steering

Emergency Steering (Driver steering assist)



A: Emergency Steering

To warn the driver that emergency steering will be assisted, the warning message will appear on the cluster, an audible warning will sound and the steering wheel will vibrate. If there is a risk of collision with a vehicle, pedestrian and cyclist in front, the steering will be assisted to help prevent collision when the driver steers the vehicle to avoid collision.

Emergency Steering will be activated in following conditions.

- Vehicle speed: 40~85 km/h (25~53 mph)

Emergency Steering (Evasive steering assist)

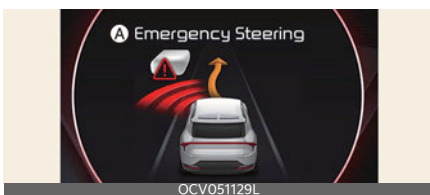

A: Emergency Steering

To warn the driver that emergency steering will be assisted, the warning message will appear on the cluster, an audible warning will sound and the steering wheel will vibrate. If there is high risk of collision with a pedestrian and cyclist in front, and the vehicle speed to operate emergency braking is within the operation range, the steering will be assisted to help prevent collision when there is space to avoid collision in the driving lane.

Emergency Steering will be activated in following conditions.

- Vehicle speed: 65~75 km/h (40~47 mph)

⚠ CAUTION

- The steering wheel may turn automatically when emergency steering is operating.
- Emergency steering will automatically cancel when risk factors disappear. If necessary, the driver must steer the vehicle.
- Emergency steering may not operate or may cancel during operation if the steering wheel is held tight or steered in the opposite direction.
- When steering is assisted to avoid collision with a vehicle, pedestrian and cyclist, Evasive steering assist will be canceled if collisions with other objects (vehicles, pedestrians, or cyclists) are expected.

- Evasive steering assist may not operate if space to avoid collision in the driving lane is insufficient.

* NOTICE

For more details on warning messages, refer to Collision Warning in "Basic Function" "Collision Warning" on page 6-43.

* NOTICE

The images or colors may be displayed differently depending on the specifications of the instrument cluster or theme.

▲ WARNING

- For your safety, change the Settings after parking the vehicle at a safe location.
- With **Active Assist** or **Warning only** selected, when ESC is turned off by pressing and holding the ESC OFF button, Forward Collision-Avoidance Assist will turn off automatically. In this case, Forward Collision-Avoidance Assist cannot be set from the Settings menu and the (警告) warning light will illuminate on the cluster which is normal. If ESC is turned on by pressing the ESC OFF button again, Forward Collision-Avoidance Assist will maintain the last setting. Forward Collision-Avoidance Assist does not operate in all situations or cannot avoid all collisions.
- The driver should hold the responsibility to control the vehicle. Do not solely depend on Forward Collision-Avoidance Assist. Rather, maintain a safe braking distance, and if necessary, depress the brake pedal to reduce driving speed or to stop the vehicle.
- Never deliberately operate Forward Collision-Avoidance Assist on people, objects, etc. It may cause serious injury or death.
- Forward Collision-Avoidance Assist may not operate if the driver depresses the brake pedal to avoid collision.
- Depending on the road and driving conditions, Forward Collision-Avoidance Assist may warn the driver late or may not warn the driver.
- During Forward Collision-Avoidance Assist operation, the vehicle may stop suddenly injuring passengers and shifting loose objects. Always have the seat belt on and keep loose objects secured.
- If any other system's warning message is displayed or audible warning is generated, Forward Collision-Avoidance Assist warning message may not be displayed and audible warning may not be generated.
- You may not hear the warning sound of Forward Collision-Avoidance Assist if the surrounding is noisy.
- Forward Collision-Avoidance Assist may turn off or may not operate properly or may operate unnecessarily depending on the road conditions and the surroundings.

⚠ WARNING

- Even if there is a problem with Forward Collision-Avoidance Assist, the vehicle's basic braking performance will operate normally.
- During emergency braking, braking control by Forward Collision-Avoidance Assist will automatically cancel when the driver excessively depresses the accelerator pedal or sharply steers the vehicle.

⚠ CAUTION

- Depending on the condition of the vehicle, pedestrian and cyclist in front and the surroundings, the speed range to operate Forward Collision-Avoidance Assist may reduce. Forward Collision-Avoidance Assist may only warn the driver, or it may not operate.
- Forward Collision-Avoidance Assist will operate under certain conditions by judging the risk level based on the condition of the oncoming vehicle, driving direction, speed and surroundings.
- When a collision with a surrounding vehicle is expected, Lane-Change Oncoming, Lane-Change Side and Evasive Steering Assist functions will only warn the driver. (if equipped)

*** NOTICE**

In a situation where collision is imminent, braking may be assisted by Forward Collision-Avoidance Assist when braking is insufficient by the driver.

Forward Collision-Avoidance Assist malfunction and limitations

Forward Collision-Avoidance Assist malfunction



A: Check Forward Safety system

When Forward Collision-Avoidance Assist is not working properly, the warning message will appear, and the (★) and (⚠) warning lights will illuminate on the cluster. Kia recommends visiting an authorized Kia dealer/service partner.

Forward Collision-Avoidance Assist disabled

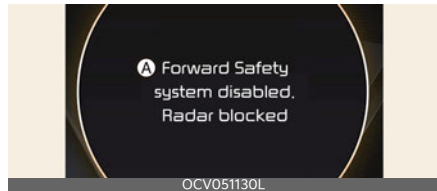

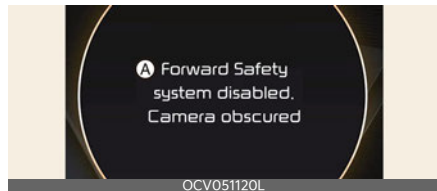

A: Forward safety system disabled. Radar blocked



A: Forward safety system disabled. Camera obscured

When the front windshield where the front view camera is located, front radar cover, bumper or sensor is covered with

foreign material, such as snow or rain, it can reduce the detecting performance and temporarily limit or disable Forward Collision-Avoidance Assist.

If this occurs the warning message, and the  and  warning lights will illuminate on the cluster.

Forward Collision-Avoidance Assist will operate normally when snow, rain or foreign material is removed.

If Forward Collision-Avoidance Assist does not operate normally after obstruction (snow, rain, or foreign material) is removed (including trailer, carrier, etc. from the rear bumper), have the vehicle inspected by a professional workshop. Kia recommends visiting an authorized Kia dealer/service partner.

WARNING

- Even though the warning message or warning light does not appear on the cluster, Forward Collision-Avoidance Assist may not properly operate.
- Forward Collision-Avoidance Assist may not properly operate in an area (e.g. open terrain), where any substance are not detected after turning ON the vehicle.

Limitations of Forward Collision-Avoidance Assist

Forward Collision-Avoidance Assist may not operate normally, or it may operate unexpectedly under the following circumstances:

- The detecting sensor or the surroundings are contaminated or damaged
- The temperature around the front view camera is high or low due to surrounding environment
- The camera lens is contaminated due to tinted, filmed or coated windshield,

damaged glass, or sticky foreign material (sticker, bug, etc.) on the glass

- Moisture is not removed or frozen on the windshield
- Washer fluid is continuously sprayed, or the wiper is on
- Driving in heavy rain or snow, or thick fog
- The field of view of the front view camera is obstructed by sun glare
- Street light or light from an oncoming vehicle is reflected on the wet road surface, such as a puddle on the road
- An object is placed on the dashboard
- Your vehicle is being towed
- The surrounding is very bright
- The surrounding is very dark, such as in a tunnel, etc.
- The brightness changes suddenly, for example when entering or exiting a tunnel
- The brightness outside is low, and the headlamps are not on or are not bright
- Driving through steam, smoke or shadow
- Only part of the vehicle, pedestrian or cyclist is detected
- The vehicle in front is a bus, heavy truck, truck with a unusually shaped luggage, trailer, etc.
- The vehicle in front has no tail lights, tail lights are located unusually, etc.
- The brightness outside is low, and the tail lamps are not on or are not bright
- The rear of the front vehicle is small or the vehicle does not look normal, such as when the vehicle is tilted, overturned, or the side of the vehicle is visible, etc.

- The front vehicle's ground clearance is low or high
- A vehicle, pedestrian or cyclist suddenly cuts in front
- The bumper around the front radar is impacted, damaged or the front radar is out of position
- The temperature around the front radar is high or low
- Driving through a tunnel or iron bridge
- Driving in large areas where there are few vehicles or structures (i.e. desert, meadow, suburb, etc.)
- Driving near areas containing metal substances, such as a construction zone, railroad, etc.
- A material is near that reflects very well on the front radar, such as a guardrail, nearby vehicle, etc.
- The cyclist in front is on a bicycle made of material that does not reflect on the front radar
- The vehicle in front is detected late
- The vehicle in front is suddenly blocked by an obstacle
- The vehicle in front suddenly changes lane or suddenly reduces speed
- The vehicle in front is bent out of shape
- The front vehicle's speed is fast or slow
- The vehicle in front steers in the opposite direction of your vehicle to avoid a collision
- With a vehicle in front, your vehicle changes lane at low speed
- The vehicle in front is covered with snow
- You are departing or returning to the lane

- Unstable driving
- You are on a roundabout and the vehicle in front is not detected
- You are continuously driving in a circle
- The vehicle in front has an unusual shape
- The vehicle in front is driving uphill or downhill
- The pedestrian or cyclist is not fully detected, for example, if the pedestrian is leaning over or is not fully walking upright
- The pedestrian or cyclist is wearing clothing or equipment that makes it difficult to detect as a pedestrian or cyclist
- The pedestrian or cyclist in front is moving very quickly

The illustration above shows the image the front view camera and front radar will detect as a vehicle, pedestrian and cyclist.



- The pedestrian or cyclist in front is short or is posing a low posture
- The pedestrian or cyclist in front has impaired mobility
- The pedestrian or cyclist in front is moving intersected with the driving direction
- There is a group of pedestrians, cyclists or a large crowd in front
- The pedestrian or cyclist is wearing clothing that easily blends into the

background, making it difficult to detect

- The pedestrian or cyclist is difficult to distinguish from the similar shaped structure in the surroundings
- You are driving by a pedestrian, cyclist, traffic signs, structures, etc. near the intersection
- Driving in a parking lot
- Driving through a tollgate, construction area, unpaved road, partial paved road, uneven road, speed bumps, etc.
- Driving on an incline road, curved road, etc.
- Driving through a roadside with trees or streetlights
- The adverse road conditions cause excessive vehicle vibrations while driving
- Your vehicle height is low or high due to heavy loads, abnormal tire pressure, etc.
- Driving through a narrow road where trees or grass are overgrown
- There is interference by electromagnetic waves, such as driving in an area with strong radio waves or electrical noise
- The bumper around the front corner radar or rear corner radar is covered with objects, such as a bumper sticker, bumper guard, bike rack, etc.
- The bumper around the front corner radar or rear corner radar is impacted, damaged or the radar is out of position
- The front corner radar or rear corner radar is blocked by other vehicles, walls or pillars
- Driving on a highway (or motorway) ramp
- Driving on a road where the guardrail or wall is in double structure
- The other vehicle drives very close behind your vehicle, or the other vehicle passes by your vehicle in close proximity
- The speed of the other vehicle is very fast that it passes by your vehicle in a short time
- Your vehicle passes by the other vehicle
- Your vehicle has started at the same time as the vehicle next to you and has accelerated
- The vehicle in the next lane moves two lanes away from you, or when the vehicle two lanes away moves to the next lane from you
- A motorcycle or bicycle is detected
- A vehicle such as a flat trailer is detected
- A big vehicle such as a bus or truck is detected
- A small moving obstacle such as a pedestrian, animal, shopping cart or a baby stroller is detected
- A vehicle with low height such as a sports car is detected

Junction Crossing, Lane-Change Oncoming, Lane-Change Side, Evasive Steering Assist function (if equipped)

- The temperature around the front corner radar or rear corner radar is high or low
- A trailer or carrier is installed around the rear corner radar
- The front corner radar or rear corner radar is covered with snow, rain, dirt, etc.

- The lane is difficult to see due to foreign material, such as rain, snow, dust, sand, oil and water puddles
- The color of the lane marking is not distinguishable from the road
- There are markings on the road near the lane or the markings on the road looks similar to the lane markings
- The shadow is on the lane marking by a median strip, trees, guardrail, noise barriers, etc.
- The lane number increases or decreases, or the lane markings are crossing
- There are more than two lane markings on the road
- The lane markings are complicated or a structure substitutes for the lines, such as a construction area
- There are road markings, such as zig-zag lanes, crosswalk markings and road signs
- The lane suddenly disappears, such as at the intersection
- The lane is very wide or narrow
- There is a curb or road edges without a lane
- The vehicle in front is driving with one side on the lane marking
- The distance to the front vehicle is extremely short

⚠ WARNING

- Driving on a curved road

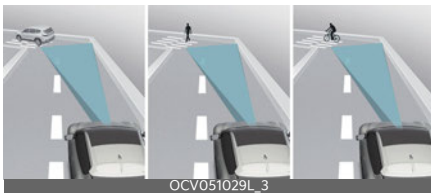

Forward Collision-Avoidance Assist may not detect other vehicles, pedestrians or cyclists in front of you on curved roads adversely affecting the performance of the sensors. This may result in no warning, braking assist or steering assist (if equipped) when necessary.

When driving on a curved road, you must maintain a safe braking distance, and if necessary, steer the vehicle and depress the brake pedal to reduce your driving speed in order to maintain a safe distance.



Forward Collision-Avoidance Assist may detect a vehicle, pedestrian or cyclist in the next lane or outside the lane when driving on a curved road.

If this occurs, Forward Collision-Avoidance Assist may unnecessarily warn the driver and control the brake or steering wheel (if equipped). Always check the traffic conditions around the vehicle.

- Driving on a sloped road

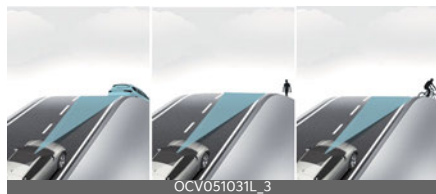

Forward Collision-Avoidance Assist may not detect other vehicles, pedestrians or cyclists in front of you while driving uphill or downhill, adversely

affecting the performance of the sensors.

This may result in unnecessary warning, braking assist or steering assist (if equipped) or no warning, braking assist or steering assist (if equipped) when necessary.

Also, vehicle speed may rapidly decrease when a vehicle, pedestrian or cyclist ahead is suddenly detected. Always have your eyes on the road while driving uphill or downhill and if necessary, steer your vehicle and depress the brake pedal to reduce your driving speed in order to maintain a safe distance.

- Changing lanes



[A]: Your vehicle, [B]: Lane changing vehicle

When a vehicle moves into your lane from an adjacent lane, it cannot be detected by the sensor until it is in the sensor's detection range. Forward Collision-Avoidance Assist may not immediately detect the vehicle when the vehicle changes lanes abruptly. In this case, you must maintain a safe braking distance, and if necessary,

steer your vehicle and depress the brake pedal to reduce your driving speed in order to maintain a safe distance.

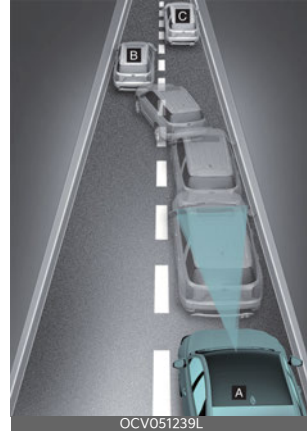

[A]: Your vehicle, [B]: Lane changing vehicle,

[C]: Same lane vehicle

When a vehicle in front of you merges out of the lane, Forward Collision-Avoidance Assist may not immediately detect the vehicle that is now in front of you. In this case, you must maintain a safe braking distance, and if necessary, steer your vehicle and depress the brake pedal to reduce your driving speed in order to maintain a safe distance.

- Detecting a vehicle

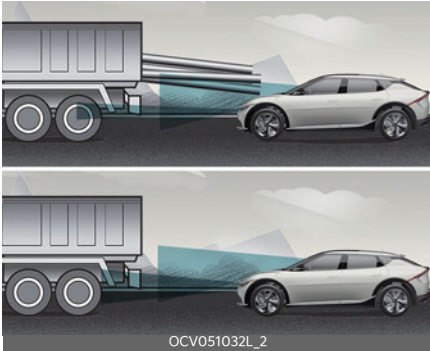

If the vehicle in front of you has cargo that extends rearward from the cab, or when the vehicle in front of you has higher ground clearance, additional special attention is required. Forward Collision-Avoidance Assist may not be able to detect the cargo extending from the vehicle. In these instances, you must maintain a safe braking distance from the rearmost object, and if necessary, steer your vehicle and depress the brake pedal to reduce your driving speed in order to maintain distance.

⚠ WARNING

- Forward Collision-Avoidance Assist may not operate normally if interfered by strong electromagnetic waves.
- Forward Collision-Avoidance Assist may not operate for 15 seconds after the vehicle is started, or the front view camera is initialized.

Lane Keeping Assist (LKA) (if equipped)

Lane Keeping Assist is designed to help detect lane markings (or road edges) while driving over a certain speed. Lane Keeping Assist will warn the driver if the vehicle leaves the lane without using the turn signal, or will automatically assist the driver's steering to help prevent the vehicle from departing the lane.

Detecting sensor

Front view camera



The front view camera is used as a detecting sensor to detect lane markings (or road edges).

Refer to the picture above for the detailed location of the detecting sensor.

⚠ CAUTION

For more details on the precautions of the front view camera, refer to "Forward Collision-Avoidance Assist (FCA) (if equipped)" on page 6-38.

Lane Keeping Assist settings

Setting features

Lane safety

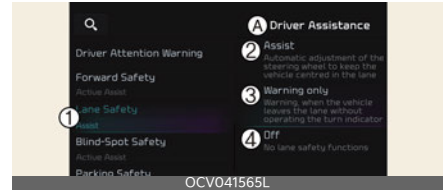

A: Driver assistance

1 Lane safety

2 Assist

3 Warning only

4 Off

With the vehicle on, select or deselect **Settings** → **Vehicle** → **Driver assistance** → **Lane safety** from the infotainment system screen to set whether or not to use each function.

- **Assist:** Lane Keeping Assist will automatically assist the driver's steering when lane departure is detected to help prevent the vehicle from moving out of its lane.
- **Warning only:** Lane Keeping Assist will warn the driver with an audible warning and steering wheel vibration when lane departure is detected. The driver must steer the vehicle.
- **Off:** Lane Keeping Assist will turn off. The indicator (🚗) light will turn off on the cluster.

⚠ WARNING

- If **Warning only** is selected, steering is not assisted.
- Lane Keeping Assist does not control the steering wheel when the vehicle is driven in the middle of the lane.

- The driver should always be aware of the surroundings and steer the vehicle if **Off** is selected.

Turning Lane Keeping Assist On/Off



Except Europe, Australia, Russia

With the vehicle on, press and hold the Lane Driving Assist button located on the steering wheel to turn on Lane Keeping Assist. The grey (LKA) indicator light will illuminate on the cluster.

Press and hold the button again to turn off the function.

If the vehicle is restarted, Lane Keeping Assist will maintain the last setting.

For Europe, Australia, Russia

Whenever the vehicle is turned on, Lane Keeping Assist will always turn on. The grey (LKA) indicator light will illuminate on the cluster.

When Lane Keeping Assist is on, press and hold the Lane Driving Assist button to turn off the function.

* NOTICE

- When the Lane Driving Assist button is pressed shortly, Lane Following Assist will turn on and off.
- When Lane Keeping Assist is turned off with the Lane Driving Assist button, the Lane Safety setting also changes to **Off**.

Warning volume

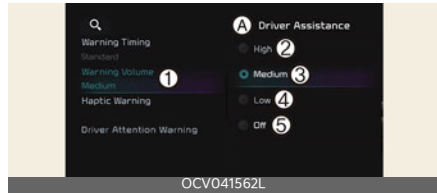

A: Driver assistance

- 1 Warning volume
- 2 High
- 3 Medium
- 4 Low
- 5 Off

With the vehicle on, select **Settings** → **Vehicle** → **Driver assistance** → **Warning volume** from the infotainment system screen to change the Warning Volume to **High**, **Medium**, **Low** or **Off** for Lane Keeping Assist.

However, even if **Off** is selected, the Hands-off Warning Volume will not be turned off. Steering wheel vibration function will also remain on even if **Off** is selected.

If you change the Warning Volume, the Warning Volume of other Driver Assistance functions may be changed.

Lane Keeping Assist operation

Warning and control

Left



Right



Lane Keeping Assist will warn and control the vehicle with Lane Departure Warning and Lane Keeping Assist.

Lane Departure Warning

- To warn the driver that the vehicle is departing from the projected lane in front, the green (🚗) indicator light will blink on the cluster, the lane line will blink on the cluster depending on which direction the vehicle is veering, and an audible warning will sound. Also, the steering wheel will vibrate.
- Vehicle speed: Approximately 60~200 km/h (40~120 mph).

Lane Keeping Assist

- To warn the driver that the vehicle is departing from the projected lane in front, the green (🚗) indicator light will blink on the cluster, and the steering wheel will make adjustments to keep vehicle inside the lane.
- Vehicle speed: Approximately 60~200 km/h (40~120 mph).

Hands-off warning



A: Keep hands on steering wheel

If the driver takes their hands off the steering wheel for several seconds, the warning message will appear on the cluster, and an audible warning will sound in stages.

⚠ WARNING

- The steering wheel may not be assisted if the steering wheel is held very tight or the steering wheel is steered over a certain degree.
- Lane Keeping Assist does not operate at all times. It is the responsibility of the driver to safely steer the vehicle and to maintain the vehicle in its lane.
- The hands-off warning message may appear late depending on road conditions. Always have your hands on the steering wheel while driving.
- If the steering wheel is held very lightly, the hands-off warning message may appear because Lane Keeping Assist may not detect that the driver has their hands on the steering wheel.
- If you attach objects to the steering wheel, the hands-off warning may not work properly.

*** NOTICE**

- For more details on setting the instrument cluster, refer to "Instrument cluster" on page 5-45.
- When lane markings (or road edges) are detected, the lane lines on the cluster will change from gray to white and the green (🚗) indicator light will illuminate.
- When the lane markings (or road edges) are detected and Highway Lane Change Assist is on, the lane lines on the cluster may change to green.

Lane undetected



Lane detected

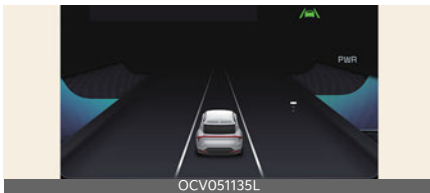

- Even though the steering is assisted by Lane Keeping Assist, the driver may control the steering wheel.
- The steering wheel may feel heavier or lighter when the steering wheel is assisted by Lane Keeping Assist than when it is not.

*** NOTICE**

The images or colors may be displayed differently depending on the specifications of the instrument cluster or theme.

Lane Keeping Assist malfunction and limitations

Lane Keeping Assist malfunction

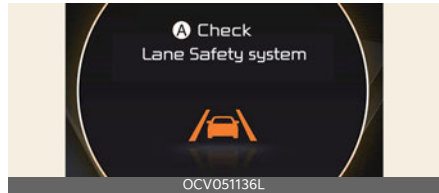

A: Check Lane Safety system

When Lane Keeping Assist is not working properly, the warning message will appear and the yellow (🚗) indicator light will illuminate on the cluster. If this occurs, have the function inspected by a professional workshop. Kia recommends visiting an authorized Kia dealer/service partner.

Limitations of Lane Keeping Assist

Lane Keeping Assist may not operate normally or may operate unexpectedly under the following circumstances:

- The lane is contaminated or difficult to distinguish because,
 - The lane markings (or road edge) is covered with rain, snow, dirt, sand, oil, puddle etc.
 - The color of the lane marking (or road edge) is not distinguishable from the road
 - There are markings (or road edges) on the road near the lane or the markings (or road edges) on the

road looks similar to the lane markings (or road edges)

- The lane marking (or road edge) is indistinct or damaged
- The shadow is on the lane marking (or road edge) by a median strip, trees, guardrail, noise barriers, etc.
- The lane number increases or decreases, or the lane markings are crossing
- There are more than two lane markings (or road edges) on the road
- The lane markings (or road edges) are complicated or a structure substitutes for the lines, such as a construction area
- There are road markings, such as zig-zag lanes, crosswalk markings and road signs
- The lane suddenly disappears, such as at the intersection
- The lane (or road width) is very wide or narrow
- There is a road edge without a lane
- There is a boundary structure in the roadway, such as a tollgate, sidewalk, curb, etc.
- The distance to the front vehicle is extremely short or the vehicle in front is covering the lane marking (or road edge)

* NOTICE

For more details on the limitations of the front view camera, refer to "Forward Collision-Avoidance Assist (FCA) (if equipped)" on page 6-38.

⚠ WARNING

Take the following precautions when using Lane Keeping Assist:

- The driver should hold the responsibility to safely drive and control the vehicle. Do not solely rely on the function and drive dangerously.
- The operation of Lane Keeping Assist can be canceled or not work properly depending on road conditions and surroundings. Always be cautious while driving.
- Refer to "Limitations of Lane Keeping Assist" if the lane is not detected properly.
- When you are towing a trailer or another vehicle, we recommend that Lane Keeping Assist is turned off due to safety reasons.
- If the vehicle is driven at high speed, the steering wheel will not be controlled. The driver must always follow the speed limit when using Lane Keeping Assist.
- If any other function's warning message is displayed or audible warning is generated, Lane Keeping Assist warning message may not be displayed and audible warning may not be generated.
- You may not hear the warning sound of Lane Keeping Assist if the surrounding is noisy.
- If you attach objects to the steering wheel, steering may not be assisted properly.
- Lane Keeping Assist may not operate for 15 seconds after the vehicle is started, or the Front view camera is initialized.

- Lane Keeping Assist will not operate when:
 - The turn signal or hazard warning flasher is turned on
 - The vehicle is not driven in the center of the lane when the function is turned on or right after changing a lane
 - ESC (Electronic Stability Control) or VSM (Vehicle Stability Management) is activated
 - The vehicle is driven on a sharp curved road
 - Vehicle speed is below 55 km/h (35 mph) or above 210 km/h (130 mph)
 - The vehicle makes sharp lane changes
 - The vehicle brakes suddenly

Blind-Spot Collision-Avoidance Assist (BCA) (if equipped)

Blind-Spot Collision-Avoidance Assist is designed to help detect and monitor approaching vehicles in the driver's blind spot area and warn the driver of a possible collision with a warning message and audible warning.

In addition, if there is a risk of collision when changing lanes or driving forward out of a parking space, Blind-Spot Collision-Avoidance Assist will help avoid collision by applying the brake.

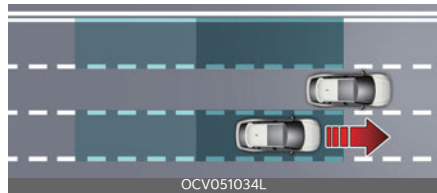

Blind-Spot Collision-Avoidance Assist helps detect and inform the driver that a vehicle is in the blind spot.

⚠ CAUTION

The detecting range may vary depending on the speed of your vehicle. However, even if there is a vehicle in the blind spot area, the function may not warn you when you pass by at high speeds.



Blind-Spot Collision-Avoidance Assist helps detect and inform the driver that a vehicle is approaching at high speed from the blind spot area.

CAUTION

Warning timing may vary depending on the speed of the vehicle approaching at high speed.



When changing lanes by detecting the lane ahead, if Blind-Spot Collision-Avoidance Assist judges that there is a collision risk with an approaching vehicle in the blind spot, it will help avoid collision by applying the brake.

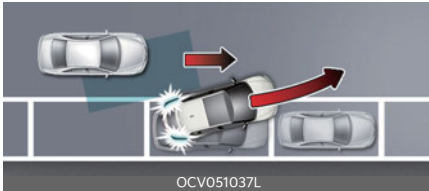

When you are driving forward out of a parking space, if Blind-Spot Collision-Avoidance Assist judges that there is a collision risk with an approaching vehicle in the blind spot, it will help avoid collision by applying the brake.

Detecting sensor

Front view camera



Rear corner radar



Refer to the picture above for the detailed location of the detecting sensors.

CAUTION

Take the following precautions to maintain optimal performance of the detecting sensor:

- Never disassemble the rear corner radar or radar assembly, or apply any impact on it.
- If there is impact on the rear corner radar or near the radar, even though the warning message does not appear on the cluster, Blind-Spot Safety system may not operate properly. Have the function be inspected by a professional workshop. Kia recommends visiting an authorized Kia dealer/service partner.
- If the rear corner radars have been replaced or repaired, have the vehicle inspected by a professional workshop. Kia recommends visiting an authorized Kia dealer/service partner.
- Use only genuine parts to repair the rear bumper where the rear corner radar is located.
- Do not apply license plate frame or objects, such as a bumper sticker, film or a bumper guard near the rear corner radar.
- Blind-Spot Collision-Avoidance Assist may not work properly if the bumper has been replaced, or the surround-

ings of the rear corner radar has been damaged or paint has been applied.

- If a trailer, carrier or other equipments is installed, it may adversely affect the performance of the rear corner radar or the function may not operate.

For more details on the precautions of the front view camera, refer to "Forward Collision-Avoidance Assist (FCA) (if equipped)" on page 6-38.

Blind-Spot Collision-Avoidance Assist settings

Setting features

Blind-spot safety

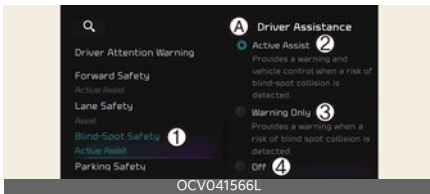

- A: Driver assistance
- 1 Blind-spot safety
 - 2 Active assistance
 - 3 Warning only
 - 4 Off

With the vehicle on, select or deselect **Settings** → **Vehicle** → **Driver assistance** → **Blind-spot safety** from the infotainment system screen to set whether or not to use each function.

- **Active assistance:** Blind-Spot Collision-Avoidance Assist will warn the driver with a warning message, an audible warning, steering wheel vibration and braking assist will be applied depending on the collision risk levels.
- **Warning only:** Blind-Spot Collision-Avoidance Assist will warn the driver

with a warning message, an audible warning and steering wheel vibration depending on the collision risk levels. Braking will not be assisted.

- **Off:** Blind-Spot Collision-Avoidance Assist will turn off.



A: Blind-Spot Safety System is Off

When the vehicle is restarted with Blind-Spot Collision-Avoidance Assist off, the **Blind-Spot Safety System is Off** message will appear on the cluster.

If you change the setting from **Off** to **Active Assist** or **Warning only**, the warning light on the outside rear view mirror will blink for three seconds.

In addition, if the vehicle is turned on, when Blind-Spot Collision-Avoidance Assist is set to **Active Assist** or **Warning only**, the warning light on the outside rear view mirror will blink for three seconds.

⚠ WARNING

- If **Warning only** is selected, braking is not assisted.
- If **Off** is selected, the driver should always be aware of the surroundings and drive safely.

* NOTICE

If the vehicle is restarted, Blind-Spot Collision-Avoidance Assist will maintain the last setting.

Warning timing



A: Driver assistance

1 Warning timing

2 Normal

3 Late

With the vehicle on, select **Settings** → **Vehicle** → **Driver assistance** → **Warning timing** from the infotainment system screen to change the initial warning activation time for Blind-Spot Collision-Avoidance Assist.

To select the Warning time **Normal** or **Late**.

- **Normal:** Use under normal driving conditions. If it feels too sensitive, set the warning timing to **Late**.
- **Late:** The warning timing will be late

Warning volume



A: Driver assistance

1 Warning volume

2 High

3 Medium

4 Low

5 Off

With the vehicle on, select **Settings** → **Vehicle** → **Driver assistance** → **Warning volume** from the infotainment sys-

tem screen to change the Warning Volume to **High, Medium, Low** or **Off** for Blind-Spot Collision-Avoidance Assist.

However, when Warning Volume is turned Off, the steering wheel vibration function will turn on if it was turned Off. If you change the Warning Volume, the warning volume of other Driver Assistance systems may change.

⚠ CAUTION

- The setting of the Warning Timing and Warning Volume applies to all functions of the Blind-Spot Collision-Avoidance Assist.
- Even though **Normal** is selected for Warning Timing, if the vehicles approaches at high speed, the initial warning activation time may seem late.
- Select **Late** for Warning Timing when traffic is light and when driving speed is slow.

Blind-Spot Collision-Avoidance Assist operation

Warning and control

Vehicle detection



- Warning light will appear in the outside rear view mirror and head-up display (if equipped).

Blind-Spot Collision-Avoidance Assist will operate as following circumstances.

- Vehicle speed: Above 20 km/h (12 mph)
- The speed of the vehicle in the blind spot area: Above 10 km/h (7 mph)

Collision warning

Collision warning will operate when the turn signal to change the lane in the direction of the vehicle in the blind spot area.

- If **Warning only** is selected from the Settings menu, the collision warning will operate when your vehicle approaches the lane the blind spot vehicle is detected.
- To warn the driver of a collision, the warning light on the side view mirror and head-up display (if equipped) will blink. At the same time, an audible warning will sound and the steering wheel will vibrate.
- When the turn signal is turned off or you move away from the lane, the collision warning will be canceled and the function will return to vehicle detection state.

⚠ WARNING

- The detecting range of the rear corner radar is determined by a standard road width, therefore, on a narrow road, the function may detect other vehicles in the two lanes away and warn you. In contrast, on a wide road, the function may not be able to detect a vehicle driving in the next lane and may not warn you.
- When the hazard warning flasher is on, the collision warning by the turn signal will not operate.

*** NOTICE**

If the driver's seat is on the left side, the collision warning may occur when you turn left. If the driver's seat is on the right side, the collision warning may occur when you turn right. Maintain a proper distance with the vehicles in the lane.

Collision-Avoidance Assist (while driving)



A: Emergency braking

- To warn the driver of a collision, the warning light on the side view mirror will blink and a warning message will appear on the cluster. At the same time, an audible warning will sound, warning light on the head-up display (if equipped) will blink and the steering wheel will vibrate. It assists in braking control to help prevent collision with the vehicle in the blind spot area.
- Collision-Avoidance Assist will be operated under the following circumstances.
 - Your vehicle speed: 60~200 km/h (40~120 mph)
 - Both lane markings of the driving lane are detected.

⚠ WARNING

- Collision-Avoidance Assist will be canceled under the following circumstances:
 - Your vehicle enters the next lane by a certain distance
 - Your vehicle is away from the collision risk
 - The steering wheel is sharply steered
 - The brake pedal is depressed
 - Forward Collision-Avoidance Assist is operating
- After Blind-Spot Collision-Avoidance Assist operation or changing lane, you must drive to the center of the lane. The function will not operate if the vehicle is not driven in the center of the lane.

Collision-Avoidance Assist (while departing)**A: Emergency braking**

- To warn the driver of a collision, the warning light on the outside rear view mirror will blink and a warning message will appear on the cluster. At the same time, an audible warning will sound, warning light on the head-up display (if equipped) will blink and the steering wheel will vibrate.
- Blind-Spot Collision-Avoidance Assist will operate when your vehicle speed is below 3 km/h (2 mph) and the

speed of the vehicle in the blind spot area is above 5 km/h (3 mph).

- Emergency braking will be assisted to help prevent collision with the vehicle in the blind spot area.

**A: Drive carefully**

When the vehicle is stopped due to emergency braking, the warning message will appear on the cluster. For your safety, the driver should depress the brake pedal immediately and check the surroundings.

- Brake control will end after the vehicle is stopped by emergency braking for approximately 2 seconds.

⚠ WARNING

Take the following precautions when using Blind-Spot Collision-Avoidance Assist:

- For your safety, change the Blind-Spot Safety system Settings after parking the vehicle at a safe location.
- If any other function's warning message is displayed or audible warning is generated, Blind-Spot Collision-Avoidance Assist's warning message may not be displayed and audible warning may not be generated.
- You may not hear the warning sound of Blind-Spot Collision-Avoidance Assist if the surrounding is noisy.
- Blind-Spot Collision-Avoidance Assist may not operate if the driver applies the brake pedal to avoid collision.

- When Blind-Spot Collision-Avoidance Assist is operating, braking control by the function will automatically cancel when the driver excessively depresses the accelerator pedal or control the steering wheel.
- During Blind-Spot Collision-Avoidance Assist operation, the vehicle may stop suddenly injuring passengers and shifting loose objects. Always have the seat belt on and keep loose objects secured.
- Even if there is a problem with Blind-Spot Collision-Avoidance Assist, the vehicle's basic braking performance will operate normally.
- Blind-Spot Collision-Avoidance Assist does not operate in all situations or cannot avoid all collisions.
- Blind-Spot Collision-Avoidance Assist may warn the driver late or may not warn the driver depending on the road and driving conditions.
- Driver should maintain control of the vehicle at all times. Do not depend on Blind-Spot Collision-Avoidance Assist. Maintain a safe braking distance, and if necessary, depress the brake pedal to reduce driving speed or to stop the vehicle.

⚠ WARNING

- The brake control may not operate properly depending on the status of ESC (Electronic Stability Control). There will only be a warning when:
 - The ESC (Electronic Stability Control) warning light is on
 - ESC (Electronic Stability Control) is engaged in a different function

*** NOTICE**

The images or colors may be displayed differently depending on the specifications of the instrument cluster or theme.

Blind-Spot Collision-Avoidance Assist malfunction and limitations

Blind-Spot Collision-Avoidance Assist malfunction

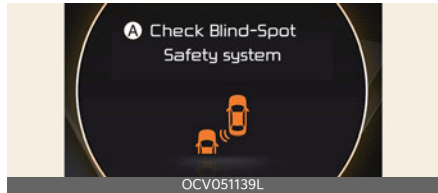

A: Check Blind-Spot Safety system

When Blind-Spot Collision-Avoidance Assist is not working properly, the warning message will appear on the cluster for several seconds, and the master warning light (⚠) will illuminate. Have Blind-Spot Collision-Avoidance Assist be inspected by a professional workshop. Kia recommends visiting an authorized Kia dealer/service partner.

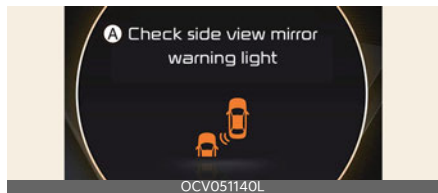

A: Check side view mirror warning light

When the outside rear view mirror warning light is not working properly, the warning message will appear on the cluster for several seconds, and the master warning light (⚠) will illuminate. Have Blind-Spot Collision-Avoidance Assist be inspected by a professional

workshop. Kia recommends visiting an authorized Kia dealer/service partner.

Blind-Spot Collision-Avoidance Assist disabled

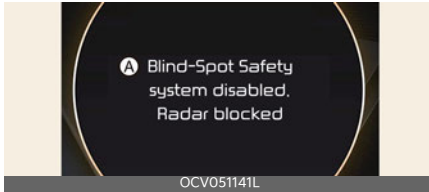

A: Blind-spot safety system disabled. Radar blocked

When the rear bumper around the rear corner radar or sensor is covered with foreign material, such as snow or rain, or installing a trailer or carrier, it can reduce the detecting performance and temporarily limit or disable Blind-Spot Collision-Avoidance Assist.

If this occurs, a warning message will appear on the cluster. However it is not a malfunction.

Blind-Spot Collision-Avoidance Assist will operate normally when such foreign material or trailer, other equipments is removed, and then the vehicle is restarted. Always keep it clean.

If Blind-Spot Collision-Avoidance Assist does not operate normally vehicle rear luggage, other equipment or foreign material is removed, have Blind-Spot Collision-Avoidance Assist be inspected by a professional workshop. Kia recommends visiting an authorized Kia dealer/service partner.

⚠ WARNING

- Even though the warning message does not appear on the cluster, Blind-Spot Collision-Avoidance Assist may not properly operate.
- Blind-Spot Collision-Avoidance Assist may not properly operate in an area (e.g. open terrain) where any substance are not detected right after the vehicle is turned on, or when the detecting sensor is blocked with foreign material right after the vehicle is turned on.

⚠ CAUTION

Turn off Blind-Spot Collision-Avoidance Assist to install a trailer, carrier, etc., or remove the trailer, carrier, etc. to use Blind-Spot Collision-Avoidance Assist.

Limitations of Blind-Spot Collision-Avoidance Assist

Blind-Spot Collision-Avoidance Assist may not operate normally as following circumstances:

- There is inclement weather, such as heavy snow, heavy rain, etc.
- The rear corner radar is covered with snow, rain, dirt, etc.
- The temperature around the rear corner radar is high or low
- The rear corner radar is covered by vehicle or pillar, walls etc.
- Driving on a highway (or motorway) ramp and tollgate.
- The road pavement (or the peripheral ground) abnormally contains metallic components (i.e. possibly due to subway construction).
- There is a fixed object near the vehicle, such as sound barriers, guardrails,

double guardrails, central dividers, entry barriers, street lamps, signs, tunnels, walls, etc. (including double structures)

- Driving through a narrow road where trees or grass are overgrown
- Driving in large areas where there are few vehicles or structures (i.e. desert, meadow, suburb, etc.)
- Driving on a wet road surface, such as a puddle on the road
- The other vehicle drives very close behind your vehicle, or the other vehicle passes by your vehicle in close proximity
- The speed of the other vehicle is very fast that it passes by your vehicle in a short time
- Your vehicle passes by the other vehicle
- Your vehicle changes lane
- Your vehicle has started at the same time as the vehicle next to you and has accelerated
- The vehicle in the next lane moves two lanes away from you, or when the vehicle two lanes away moves to the next lane from you
- A trailer or carrier is installed around the rear corner radar
- The bumper around the rear corner radar is covered with objects, such as a bumper sticker, bike rack, etc.
- The bumper around the rear corner radar is impacted, damaged or the radar is out of position
- Your vehicle height is low or high due to heavy loads, abnormal tire pressure, etc.

Blind-Spot Collision-Avoidance Assist may not operate normally, or it may

operate unexpectedly when the following objects are detected:

- A motorcycle or bicycle is detected
- A vehicle such as a flat trailer is detected
- A big vehicle such as a bus or truck is detected
- A moving obstacle such as a pedestrian, animal, shopping cart or a baby stroller is detected
- A vehicle with low height such as a sports car is detected

Braking control may not work as following circumstances:

- The vehicle severely vibrates while driving over a bumpy road, uneven road or concrete patch
- Driving on a slippery surface due to snow, water puddle, ice, etc.
- The tire pressure is low or a tire is damaged
- The brake is reworked
- The vehicle makes abrupt lane changes

*** NOTICE**

For more details on the limitations of the front view camera, refer to "Forward Collision-Avoidance Assist (FCA) (if equipped)" on page 6-38 and "Lane Keeping Assist (LKA) (if equipped)" on page 6-57.

WARNING

- Driving on a curved road



Blind-Spot Collision-Avoidance Assist may not operate properly when driving on a curved road. Blind-Spot Collision-Avoidance Assist may not detect the vehicle in the next lane.

Always pay attention to road and driving conditions while driving.



Blind-Spot Collision-Avoidance Assist may not operate properly when driving on a curved road. Blind-Spot Collision-Avoidance Assist may detect a vehicle in the same lane.

Always pay attention to road and driving conditions while driving.

- Driving where the road is merging/dividing



Blind-Spot Collision-Avoidance Assist may not operate properly when driving where the road merges or divides. Blind-Spot Collision-Avoidance Assist

may not detect the vehicle in the next lane.

Always pay attention to road and driving conditions while driving on the road merges or divides.

- Driving on a sloped road

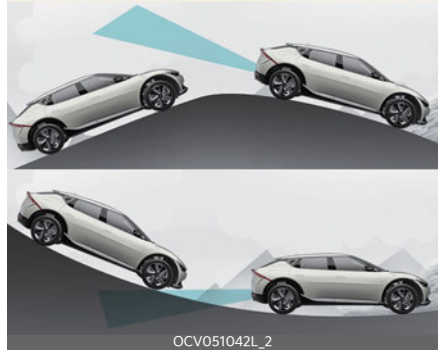

Blind-Spot Collision-Avoidance Assist may not operate properly when driving on a sloped road. Blind-Spot Collision-Avoidance Assist may not detect the vehicle in the next lane or may incorrectly detect the ground or structure.

Always pay attention to road and driving conditions while driving.

- Driving where the heights of the lanes are different



Blind-Spot Collision-Avoidance Assist may not operate properly when driving where the heights of the lanes are different. Blind-Spot Collision-Avoidance Assist may not detect the vehicle on a road with different lane heights.

Always pay attention to road and driving conditions while driving.

⚠ WARNING

- When you are towing a trailer or another vehicle, make sure that you turn off Blind-Spot Collision-Avoidance Assist.
- Blind-Spot Collision-Avoidance Assist may not operate normally if interfered by strong electromagnetic waves.
- Blind-Spot Collision-Avoidance Assist may not operate for approximately 15 seconds after the vehicle is started, or the front view camera or rear corner radars are initialized.

Safe Exit Warning (SEW) (if equipped)



After the vehicle stops, when an approaching vehicle from the rear area is detected as soon as a passenger opens a door, Safe Exit Warning will warn the driver with a warning message and an audible warning to help prevent a collision.

⚠ CAUTION

Warning timing may vary depending on the speed of the approaching vehicle.

Detecting sensor

Rear corner radar



Refer to the picture above for the detailed location of the detecting sensors.

⚠ CAUTION

For more details on the precautions of the rear corner radars, refer to "Blind-Spot Collision-Avoidance Assist (BCA) (if equipped)" on page 6-62.

Safe Exit Warning settings

Setting features

SEW (Safe Exit Warning)

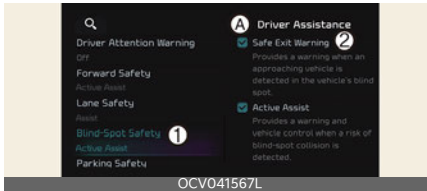

A: Driver assistance

1 Blind-spot safety

2 SEW (Safe Exit Warning)

With the vehicle on, select **Settings** → **Vehicle** → **Driver assistance** → **Blind-spot safety** → **SEW (Safe Exit Warning)** from the infotainment system screen to turn on Safe Exit Warning and deselect to turn off the function.

⚠ WARNING

The driver should always be aware of unexpected and sudden situations from occurring. If **SEW (Safe Exit Warning)** is deselected, Safe Exit Warning cannot assist you.

* NOTICE

If the vehicle is restarted, Safe Exit Warning will maintain the last setting.

Warning volume



A: Driver assistance

1 Warning volume

2 High

3 Medium

4 Low

5 Off

With the vehicle on, select **Settings** → **Vehicle** → **Driver assistance** → **Warning volume** from the infotainment system screen to change the warning volume to **High**, **Medium**, or **Low** or **Off** for Safe Exit Warning.

However, even if **Off** is selected, the Warning Volume of Safe Exit Warning will not turn off but the volume will sound as **Low**.

If you change the warning volume, the warning volume of other Driver Assistance systems may change.

⚠ CAUTION

The setting of the Warning Volume applies to all functions of the Safe Exit Warning.

Safe Exit Warning operation

Warning

Safe Exit Warning warns the following actions.

Collision warning when exiting vehicle



A: Watch for traffic

- The warning light on the side view mirror will blink and the warning message will appear on the cluster, and an audible warning will sound.
- Safe Exit Warning will warn under the following circumstances:
 - Your vehicle speed: below 3 km/h (2 mph)
 - The speed of the approaching vehicle from the rear: above 6 km/h (4 mph)

⚠ WARNING

Take the following precautions when using Safe Exit Warning:

- For your safety, change the Settings after parking the vehicle at a safe location.
- If any other function's warning message is displayed or audible warning

is generated, Safe Exit Warning warning message may not be displayed and audible warning may not be generated.

- You may not hear the warning sound of Safe Exit Warning if the surrounding is noisy.
- Safe Exit Warning does not operate in all situations or cannot prevent all collisions.
- Safe Exit Warning may warn the driver late or may not warn the driver depending on driving conditions. Always check vehicle surroundings.
- The driver and passengers are responsible for accidents that occurs while exiting the vehicle. Always check the surroundings before you exit the vehicle.
- Safe Exit Warning does not operate if there is a problem with Blind-Spot Collision-Avoidance Assist.
- The warning message of Blind-Spot Collision-Avoidance Assist will appear when:
 - Blind-Spot Collision-Avoidance Assist sensor or the sensor surrounding is polluted or covered
 - Blind-Spot Collision-Avoidance Assist fails to warn passengers or falsely warn passengers

*** NOTICE**

- After the vehicle is turned off, Safe Exit Warning operates for 3 minutes, but turns off immediately if the doors are locked.
- Images or colors may be displayed differently depending on the instrument cluster specifications or theme.

Safe Exit Warning malfunction and limitations

Safe Exit Warning malfunction



A: Check Blind-Spot Safety system

When Safe Exit Warning is not working properly, the warning message will appear on the cluster, and the master warning light (⚠) will illuminate on the cluster. Have Safe Exit Warning be inspected by a professional workshop. Kia recommends visiting an authorized Kia dealer/service partner.

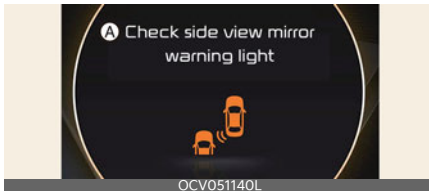

A: Check side view mirror warning light

When the side view mirror warning light is not working properly, the warning message will appear on the cluster for several seconds, and the master warning light (⚠) will illuminate on the cluster. Have Safe Exit Warning be inspected by a professional workshop. Kia recommends visiting an authorized Kia dealer/service partner.

Safe Exit Warning disabled

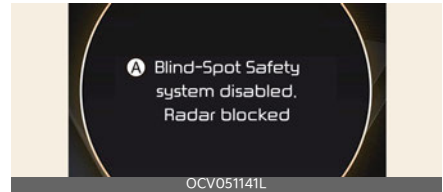

A: Blind-spot safety system disabled. Radar blocked

When the rear bumper around the rear corner radar or sensor is covered with foreign material, such as snow or rain, or installing a trailer or carrier, it can reduce the detecting performance and temporarily limit or disable Safe Exit Warning.

If this occurs, the **Blind-Spot Safety system disabled. Radar blocked** warning message will appear on the cluster. Safe Exit Warning will operate normally when such foreign material or trailer, etc. is removed, and then the vehicle is restarted.

If Safe Exit Warning does not operate normally after it is removed, Kia recommends visiting an authorized Kia dealer/service partner.

⚠ WARNING

- Even though the warning message does not appear on the cluster, Safe Exit Warning may not properly operate.
- Safe Exit Warning may not properly operate in an area (e.g., open terrain), where any substance are not detected right after the vehicle is turned on, or when the detecting sensor is blocked with foreign material right after the vehicle is turned on.

⚠ CAUTION

Turn off Safe Exit Warning to install a trailer, carrier, etc., or remove the trailer, carrier, etc. to use Safe Exit Warning.

Limitations of Safe Exit Warning

Safe Exit Warning may not operate normally, or Safe Exit Warning may operate unexpectedly under the following warning.

- Getting out of the vehicle where trees or grass are overgrown
- Getting out of the vehicle where the road is wet
- The approaching vehicle is very fast or very slow

*** NOTICE**

For more details on the precautions of the rear corner radars, refer to "Blind-Spot Collision-Avoidance Assist (BCA) (if equipped)" on page 6-62.

⚠ WARNING

- Safe Exit Warning may not operate normally if interfered by strong electromagnetic waves.
- Safe Exit Warning may not operate for 3 seconds after the vehicle is restarted, or the rear corner radars are initialized.

Safe Exit Assist (SEA) (if equipped)



After the vehicle stops, when an approaching vehicle from the rear area is detected as soon as a passenger opens a door, Safe Exit Assist will warn the driver with a warning message and an audible warning to help prevent a collision.



In addition, when the electronic child safety lock button is in the LOCK position and an approaching vehicle from the rear area is detected, the electronic child safety lock button will not unlock even if the driver presses the button to prevent the rear doors from opening.

⚠ CAUTION

Warning timing may vary depending on the speed of the approaching vehicle.

Detecting sensor

Rear corner radar



Refer to the picture above for the detailed location of the detecting sensors.

⚠ CAUTION

For more details on the precautions of the rear corner radars, refer to "Blind-Spot Collision-Avoidance Assist (BCA) (if equipped)" on page 6-62.

Safe Exit Assist settings

Setting features

SEA (Safe Exit Assist)

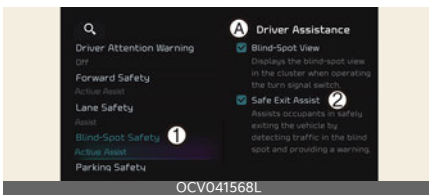

A: Driver assistance

1 Blind-spot safety

2 SEA (Safe Exit Assist)

With the vehicle on, select **Settings** → **Vehicle** → **Driver assistance** → **Blind-spot safety** → **SEA (Safe Exit Assist)** from the infotainment system screen to turn on Safe Exit Assist and deselect to turn off Safe Exit Assist.

⚠ WARNING

The driver should always be aware of unexpected and sudden situations from occurring. If **SEA (Safe Exit Assist)** is deselected, Safe Exit Assist cannot assist you.

* NOTICE

If the vehicle is restarted, Safe Exit Assist will maintain the last setting.

Warning volume

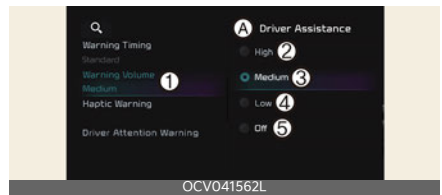

A: Driver assistance

1 Warning volume

2 High

3 Medium

4 Low

5 Off

With the vehicle on, select **Settings** → **Vehicle** → **Driver assistance** → **Warning volume** from the infotainment system screen to change the warning volume to **High**, **Medium**, **Low** or **Off** for Safe Exit Assist.

However, even if **Off** is selected, the Warning Volume of Safe Exit Assist will not turn off but the volume will sound as **Low**.

If you change the Warning Volume, the warning volume of other Driver Assistance systems may change.

⚠ CAUTION

The setting of the Warning Volume applies to all functions of the Safe Exit Assist.

Safe Exit Assist operation

Warning and control

Safe Exit Assist warns and controls with the following actions.

Collision warning when exiting vehicle



A: Watch for traffic

- The warning light on the side view mirror will blink and the warning message will appear on the cluster, and an audible warning will sound.
- Safe Exit Assist will warn under the following circumstances:
 - Your vehicle speed: below 3 km/h (2 mph)
 - The speed of the approaching vehicle from the rear: above 6 km/h (4 mph)

Safe Exit Assist linked with Electronic child safety lock

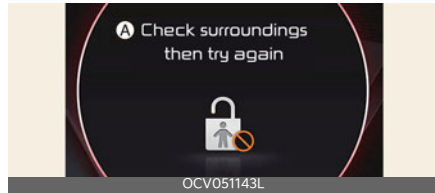

A: Check surroundings then try again

- When Electric child safety lock is operating and an approaching vehicle from the rear area is detected, the rear doors cannot be unlocked even if the driver tries to unlock the rear doors using the electronic child safety lock button. The warning light on the outside rearview mirror will blink and the warning message will appear on the cluster.
- Safe Exit Assist will warn under the following circumstances:
 - Your vehicle speed: below 3 km/h (2 mph)
 - The speed of the approaching vehicle from the rear: above 6 km/h (4 mph)

⚠ CAUTION

If the driver presses the electronic child safety lock button (🔒) again within 10 seconds after the warning message appears, Safe Exit Assist judges that the driver has unlocked the door and the door will open regardless of vehicles approaching. The electronic child safety lock will turn off (button indicator OFF). Always check the surroundings before turning off the electronic child safety lock button.

*** NOTICE**

If a rear door is opened from the outside, it will open regardless of Safe Exit Assist operation.

⚠ WARNING

Take the following precautions when using Safe Exit Assist:

- For your safety, change the Settings after parking the vehicle at a safe location.
- If any other function's warning message is displayed or audible warning is generated, Safe Exit Assist warning message may not be displayed and audible warning may not be generated.
- You may not hear the warning sound of Safe Exit Assist if the surrounding is noisy.
- Safe Exit Assist does not operate in all situations or cannot prevent all collisions.
- Safe Exit Assist may warn the driver late or may not warn the driver depending on the road and driving conditions. Always check vehicle surroundings.
- The driver and passengers are responsible for accidents that occurs while exiting the vehicle. Always check the surroundings before you exit the vehicle.
- Never deliberately operate Safe Exit Assist. Doing so may lead to serious injury or death.
- Safe Exit Assist does not operate if there is a problem with Blind-Spot Collision-Avoidance Assist.
- The warning message of Blind-Spot Collision-Avoidance Assist will appear when:

- Blind-Spot Collision-Avoidance Assist sensor or the sensor surrounding is polluted or covered
- Blind-Spot Collision-Avoidance Assist fails to warn passengers or falsely warn passengers

*** NOTICE**

- After the vehicle is turned off, Safe Exit Assist operates for 3 minutes, but turns off immediately if the doors are locked.
- Images or colors may be displayed differently depends on the instrument cluster specifications or theme.

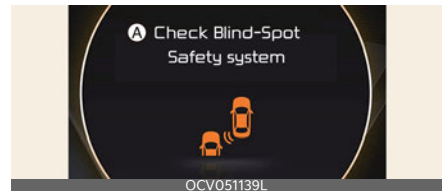
Safe Exit Assist malfunction and limitations**Safe Exit Assist malfunction****A: Check Blind-Spot Safety system**

When Safe Exit Assist is not working properly, the warning message will appear and (⚠) warning lights will illuminate on the cluster, and Safe Exit Assist will turn off automatically or Safe Exit Assist will be limited. Have Safe Exit Assist be inspected by a professional workshop. Kia recommends visiting an authorized Kia dealer/service partner.



A: Check side view mirror warning light

When the side view mirror warning light is not working properly, the warning message will appear on the cluster for several seconds, and (A) warning light will illuminate on the cluster. Have Safe Exit Assist be inspected by a professional workshop. Kia recommends visiting an authorized Kia dealer/service partner.

Safe Exit Assist disabled

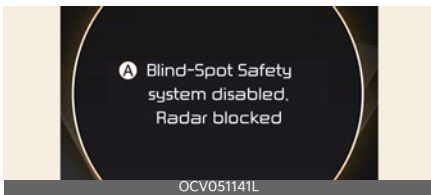

A: Blind-Spot Safety system disabled. Radar blocked

When the rear bumper around the rear corner radar or sensor is covered with foreign material, such as snow or rain, or installing a trailer or carrier, it can reduce the detecting performance and temporarily limit or disable Safe Exit Assist.

If this occurs, the **Blind-Spot Safety system disabled. Radar blocked** warning message will appear on the cluster. Safe Exit Assist will operate normally when such foreign material or trailer, etc. is removed, and then the vehicle is restarted.

If Safe Exit Assist does not operate normally after it is removed, Kia recommends visiting an authorized Kia dealer/service partner.

⚠ WARNING

- Even though the warning message does not appear on the cluster, Safe Exit Assist may not properly operate.
- Safe Exit Assist may not properly operate in an area (e.g., open terrain), where any substance are not detected right after the vehicle is turned on, or when the detecting sensor is blocked with foreign material right after the vehicle is turned on.

⚠ CAUTION

Turn off Safe Exit Assist to install a trailer, carrier, other equipment, or remove the trailer, carrier, etc. to use Safe Exit Assist.

Limitations of Safe Exit Assist

Safe Exit Assist may not operate normally, or Safe Exit Assist may operate unexpectedly under the following circumstances:

- Getting out of the vehicle where trees or grass are overgrown
- Getting out of the vehicle where the road is wet
- The approaching vehicle is very fast or very slow

*** NOTICE**

For more details on the limitations of the rear corner radar, refer to "Blind-Spot Collision-Avoidance Assist (BCA) (if equipped)" on page 6-62.

WARNING

- Safe Exit Assist may not operate normally if interfered by strong electromagnetic waves.
- Safe Exit Assist may not operate for 3 seconds after the vehicle is started, or the rear corner radars are initialized.

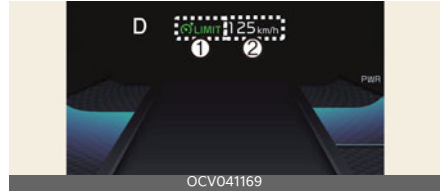
Manual Speed Limit Assist (MSLA)

- 1 Speed Limit indicator
- 2 Set speed

You can set the speed limit when you do not want to drive over a specific speed.

If you drive over the preset speed limit, the warning function operates (set speed limit will blink and chime will sound) until the vehicle speed returns within the speed limit.

Manual Speed Limit Assist operation**Setting speed limit**

1. Press and hold Driving Assist (DA) button at the desired speed.



The speed limit indicator (LIMIT) light will illuminate on the cluster.

2. Push the + switch up or - switch down, and release it at the desired speed. Push the + switch up or - switch down and hold it. The speed will increase or decrease to the nearest multiple of ten (multiple of five in mph) at first, and then increase or decrease by 10 km/h (5 mph).



3. The set speed limit (1) will be displayed on the cluster. If you would like to drive over the preset speed limit, depress the accelerator pedal beyond the pressure point to activate the kick-down mechanism.

The set speed limit will blink and chime will sound until you return the vehicle speed within the speed limit.



*** NOTICE**

When the accelerator pedal is not depressed beyond the pressure point, vehicle speed will maintain within the speed limit.

Temporarily pausing Manual Speed Limit Assist



Push the (⏏) switch to temporarily pause the set speed limit. The set speed limit will turn off but the Speed Limit indicator (SPEED LIMIT) will stay on.

Resuming Manual Speed Limit Assist



To resume Manual Speed Limit Assist after the function was paused, push the +, -, (⏏) switch.

If you push the + switch up or - switch down, vehicle speed will be set to the current speed on the cluster.

If you push the (⏏) switch, vehicle speed will resume to the preset speed.

Turning off Manual Speed Limit Assist



Press the Driving Assist (🚗) button to turn Manual Speed Limit Assist off. The Speed Limit indicator (🚗LIMIT) will go off.

Always press the Driving Assist (🚗) button to turn Manual Speed Limit Assist off when not in use.

⚠️ WARNING

Take the following precautions when using Manual Speed Limit Assist:

- Always set the vehicle speed to the speed limit in your country.
- Keep Manual Speed Limit Assist off when the function is not in use, to avoid inadvertently setting a speed. Check that the Speed Limit indicator (🚗LIMIT) is off.
- Manual Speed Limit Assist does not substitute for proper and safe driving. It is the responsibility of the driver to always drive safely and should always be aware of unexpected and sudden situations from occurring. Pay attention to the road conditions at all times.

* NOTICE

The images or colors may be displayed differently depending on the specifications of the instrument cluster or theme.

Intelligent Speed Limit Assist (ISLA) (if equipped)

Intelligent Speed Limit Assist uses information from the detected road sign and navigation system to inform the driver of the speed limit and additional road signs of the current road. Also, the function helps the driver to maintain within the speed limit of the road.

⚠️ CAUTION

- Intelligent Speed Limit Assist may not operate properly if the function is used in other countries.
- Update navigation system regularly for Intelligent Speed Limit Assist to operate normally.

Detecting sensor

Front view camera



Refer to the picture above for the detailed location of the detecting sensor.

⚠️ CAUTION

For more precautions related to the camera sensor, refer to "Forward Collision-Avoidance Assist (FCA) (if equipped)" on page 6-38.

Intelligent Speed Limit Assist settings

Setting features

Speed limit

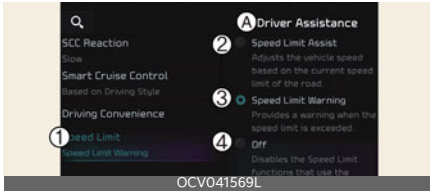

A: Driver assistance

- 1 Speed limit
- 2 Speed limit assist
- 3 Speed limit warning
- 4 Off

With the vehicle on, select or deselect **Settings** → **Vehicle** → **Driver assistance** → **Speed limit** from the Settings menu to set whether or not to use each function.

- If **Speed limit Assist** is selected, Intelligent Speed Limit Assist will inform the driver of speed limit and additional road signs. In addition, Intelligent Speed Limit Assist will inform the driver to change set speed of Manual Speed Limit Assist and/or Smart Cruise Control to help the driver stay within the speed limit.
- If **Speed limit warning** is selected, Intelligent Speed Limit Assist will inform the driver of speed limit and additional road signs. In addition, Intelligent Speed Limit Assist will warn the driver when the vehicle is driven faster than the speed limit. Manual Speed Limit Assist or Smart Cruise Control set speed will not be automatically adjusted. The driver should adjust the speed manually.

- If **Off** is selected, Intelligent Speed Limit Assist will turn off.

Speed limit offset

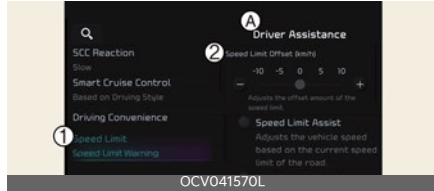

A: Driver assistance

- 1 Speed limit
- 2 Speed limit offset (km/h)

With the vehicle on, when **Settings** → **Vehicle** → **Driver assistance** → **Speed limit** → **Speed limit offset** is selected, the Speed Limit Offset can be changed. Speed Limit Warning and Speed Limit Assist will operate by applying the Speed Limit Offset setting to the detected speed limit.

⚠ WARNING

- For your safety, change the Settings after parking the vehicle at a safe location.
- Speed Limit Assist function operates based on the Offset setting added to the speed limit. If you want to change the set speed according to the speed limit, set the offset to **0**.
- Speed Limit Warning function warns the driver when driving speed exceeds the speed at which the set Offset is added to speed limit. If you want Speed Limit Warning to warn you immediately when the driving speed exceeds the speed limit, set the offset to **0**.

*** NOTICE**

The setting of **Speed limit offset** is not reflected in Navigation-based Smart Cruise Control (NSCC).

Intelligent Speed Limit Assist operation

Warning and control

Intelligent Speed Limit Assist will warn and control the vehicle by 'Displaying speed limit', 'Warning overspeed' and 'Changing set speed'.

*** NOTICE**

Intelligent Speed Limit Assist warning and control are described based on the Offset set to **0**. For details on Offset setting, refer to "Intelligent Speed Limit Assist settings" on page 6-84.

Displaying speed limit



Speed limit information is displayed on the instrument cluster.

*** NOTICE**

- If speed limit information of the road cannot be recognized, '---' sign will be displayed. Please refer to "Limitations of Intelligent Speed Limit Assist" if the road signs are difficult to recognize.
- Intelligent Speed Limit Assist provides additional road sign information in addition to speed limit. The additional

road sign information provided may vary according to your country.

- Supplementary sign displayed under the speed limit or overtaking restriction sign means the conditions under which the signs must be followed. If the supplementary sign is not recognized, it will be displayed as blank.

Warning overspeed

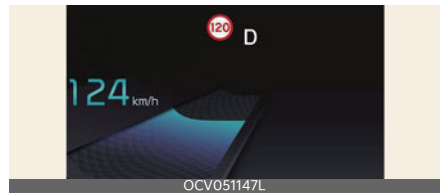

When driving at a speed higher than the displayed speed limit, the red speed limit indicator will blink.

Changing set speed

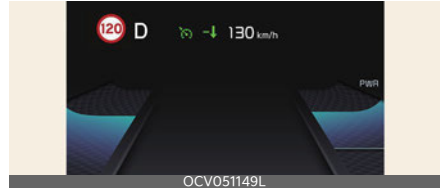
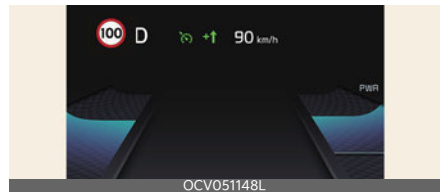

If the speed limit of the road changes during the operation of Manual Speed Limit Assist or Smart Cruise Control, an arrow in the direction of up or down is displayed to inform the driver that the set speed needs to be changed. At this

time, the driver can change the set speed according to the speed limit by using the + or - switch on the steering wheel.

⚠ WARNING

- If the Offset is set over **0**, the set speed will change to a higher speed than the speed limit of the road. If you want to drive below the speed limit, set the Offset under **0** or use the - switch on the steering wheel to lower the set speed.
- Even after changing the set speed according to the speed limit of the road, the vehicle can still be driven over the speed limit. If necessary, depress the brake pedal to reduce your driving speed.
- If the speed limit of the road is under 30 km/h (20 mph), the set speed change function will not work.
- Intelligent Speed Limit Assist operates using the speed unit in the instrument cluster set by the driver. If the speed unit is set to a unit other than the speed unit used in your country, Intelligent Speed Limit Assist may not operate properly.

*** NOTICE**

- For more details on function operation of Manual Speed Limit Assist, refer to "Manual Speed Limit Assist (MSLA)" on page 6-81.
- For more details on operation of Smart Cruise Control, refer to "Smart Cruise Control (SCC) (if equipped)" on page 6-98.

*** NOTICE**

The images or colors may be displayed differently depending on the specifications of the instrument cluster or theme.

Intelligent Speed Limit Assist malfunction and limitations

Intelligent Speed Limit Assist malfunction

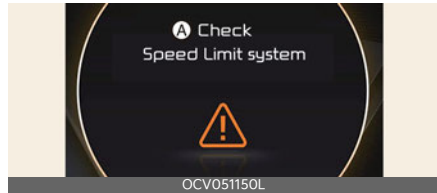

A: Check Speed Limit system

When Intelligent Speed Limit Assist is not working properly, the warning message will appear on the cluster for several seconds, and the master (⚠) warning light will illuminate on the cluster. If this occurs, we recommend the function checked by an authorized Kia dealer/service partner.

Intelligent Speed Limit Assist disabled

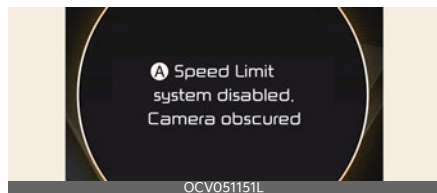

A: Speed limit system disabled. Camera obscured

When the front windshield where the front view camera is located is covered with foreign material, such as snow or rain, it can reduce the detecting perfor-

mance and temporarily limit or disable Intelligent Speed Limit Assist.

If this occurs, the warning message will appear on the cluster. The function will operate normally when snow, rain or foreign material is removed.

If Intelligent Speed Limit Assist does not operate normally after it is removed, we recommend the function checked by an authorized Kia dealer/service partner.

* NOTICE

Even though the warning message or warning light does not appear on the cluster, Intelligent Speed Limit Assist may not operate properly.

Limitations of Intelligent Speed Limit Assist

Intelligent Speed Limit Assist may not operate normally, or the function may operate unexpectedly under the following circumstances:

- The road sign is contaminated or indistinguishable
 - The road sign is difficult to see due to bad weather, such as rain, snow, fog, etc.
 - The road sign is not clear or damaged
 - The road sign is partially obscured by surrounding objects or shadow
 - A road sign near the road you are driving is detected
- The road signs do not conform to the standard
 - The text or picture on the road sign is different from the standard
 - The road sign is installed between the main line and the exit road or between diverging roads
- A conditional road sign is not installed with a sign located on the road to enter or exit
- A sign is attached to another vehicle
- The distance between the vehicle and the road signs is too far
- The vehicle encounters illuminating road signs
- Intelligent Speed Limit Assist incorrectly recognizes numbers in the street signals or other signs as the speed limit
- The minimum speed limit sign is on the road
- The brightness changes suddenly, for example when entering or exiting a tunnel or passing under a bridge
- Headlamps are not used or the brightness of the headlamps are weak at night or in the tunnel
- Road signs are difficult to recognize due to the reflection of sunlight, street lights, or oncoming vehicles
- The navigation information or GPS information contain errors.
- The driver does not follow the guide of the navigation.
- The driver is driving a new road that is not in the navigation system yet.
- The field of view of the Front view camera is obstructed by sun glare
- Driving on a road that is sharply curved or continuously curved
- Driving through speed bumps, or driving up and down or left to right on steep inclines
- The vehicle is shaking heavily
- There is an error in the navigation map information or GPS information

- The driver is not driving along the navigation guide route
- Driving on a newly opened road

⚠ WARNING

- Intelligent Speed Limit Assist is a supplemental function that helps the driver to comply with the speed limit on the road, and may not display the correct speed limit or control the driving speed properly.
- Always set the vehicle speed to the speed limit in your country.

*** NOTICE**

For more details on the limitations of the front view camera, refer to "Forward Collision-Avoidance Assist (FCA) (if equipped)" on page 6-38.

Driver Attention Warning (DAW) (if equipped)

Basic function

Driver Attention Warning will help determine the driver's attention level by analyzing driving pattern, driving time, etc. while vehicle is being driven. Driver Attention Warning will recommend a break when the driver's attention level falls below a certain level.

Leading vehicle departure alert function

Leading Vehicle Departure Alert function will inform the driver when the front vehicle departs from a stop.

Detecting sensor

Front view camera



The front view camera is used to detect driving patterns and front vehicle departure while vehicle is being driven.

Refer to the picture above for the detailed location of the detecting sensor.

⚠ CAUTION

Always keep the front view camera in good condition to maintain optimal performance of Driver Attention Warning.

For more details on the precautions of the front view camera, refer to "Forward Collision-Avoidance Assist (FCA) (if equipped)" on page 6-38.

Driver Attention Warning settings

Setting features

DAW (Driver Attention Warning)

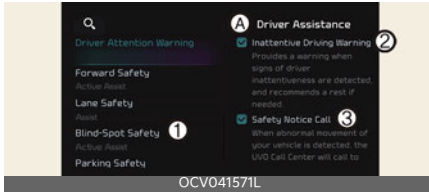

A: Driver assistance

- 1 DAW (Driver Attention Warning)
- 2 Inattentive driving warning
- 3 Safety Notice Call

With the vehicle on, select or deselect **Settings** → **Vehicle** → **Driver assistance** → **DAW (Driver Attention Warning)** from the infotainment system screen to set whether or not to use each function.

- Inattentive Driving Warning: Driver Attention Warning will inform the driver the driver's attention level and will recommend taking a break when the level falls below a certain level.

* NOTICE

Whenever the vehicle is turned on, Inattentive Driving Warning will always turn on. (For Europe, Australia, Russia)

Leading Vehicle Departure Alert

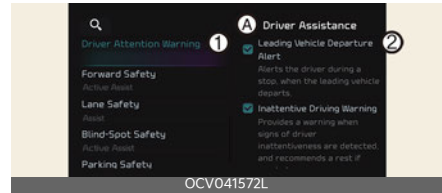

A: Driver assistance

- 1 DAW (Driver Attention Warning)
- 2 Leading Vehicle Departure Alert

Leading Vehicle Departure Alert: The function will inform the driver when the front vehicle departs from a stop.

Warning timing



A: Driver assistance

- 1 Warning timing
- 2 Normal
- 3 Late

With the vehicle on, select **Settings** → **Vehicle** → **Driver assistance** → **Warning timing** from the infotainment system screen to change the initial warning activation time for Driver Attention Warning.

- **Normal**: Use in a normal driving environment. If Driver Attention Warning operates too sensitive, set the warning timing to **Late**.
- **Late**: The warning timing will be late

*** NOTICE**

If you change the Warning Timing, the warning time of other Driver Assistance systems may change. If the vehicle is restarted, Driver Warning Time will maintain the last setting.

Driver Attention Warning operation

Basic function

Display and warning

The basic functions of the Driver Attention Warning include:

- Attention Level
- Consider taking a break

Attention level

Function off

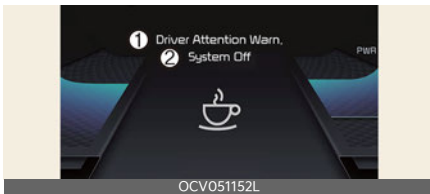

- 1 Driver Attention Warning
- 2 System Off

Standby/Disabled

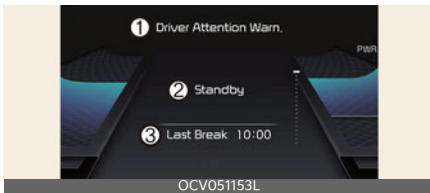

- 1 Driver Attention Warning
- 2 Standby
- 3 Last Break

Attentive driving

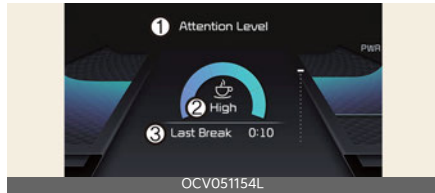

- 1 Attention Level
- 2 High
- 3 Last Break

Inattentive driving

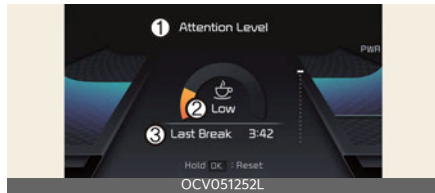

- 1 Attention Level
- 2 Low
- 3 Last Break

The driver's attention level is displayed on the scale of 1 to 5. The lower the level is, the more inattentive the driver is. The level decreases when the driver does not take a break for a certain period of time.

Driver Attention Warning (DAW) operates under the following conditions:

- The vehicle speed: Approximately 0~210 km/h (0~130 mph).

When the **Inattentive driving warning** is deselected from the Settings menu, **System Off** is displayed.

When vehicle speed is not within the operating speed, the message **Standby** will be displayed.

Taking a break

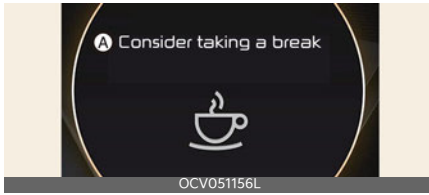

A: Consider taking a break

The warning message will appear on the cluster and an audible warning will sound to suggest that the driver take a break, when the driver's attention level is below 1.

Driver Attention Warning will not suggest a break when the total driving time is shorter than 10 minutes or 10 minutes has not passed after the last break was suggested.

⚠ WARNING

For your safety, change the Settings after parking the vehicle at a safe location.

⚠ CAUTION

- Driver Attention Warning may suggest a break depending on the driver's driving pattern or habits, even if the driver doesn't feel fatigued.
- Driver Attention Warning is a supplemental function and may not be able to determine whether the driver is inattentive.
- The driver who feels fatigued should take a break at a safe location, even though there is no break suggestion by Driver Attention Warning.

* NOTICE

- For more details on setting the instrument cluster, refer to "Instrument cluster" on page 5-45.
- Driver Attention Warning will reset the last break time to 00:00 in the following situations:
 - The vehicle is turned off
 - The driver unfastens the seat belt and opens the driver's door.
 - The vehicle is stopped for more than 10 minutes.
- When the driver resets Driver Attention Warning, the last break time is set to 0:00 and the driver's attention level is set to High.

Leading vehicle departure alert function



A: Leading vehicle is driving away

When the front vehicle departs from a stop, Leading Vehicle Departure Alert will inform the driver by displaying the warning message on the cluster and an audible warning will sound.

⚠ WARNING

- If any other function's warning message is displayed or audible warning is generated, Leading Vehicle Departure Alert warning message may not be displayed and audible warning may not be generated.

- The driver should hold the responsibility to safely drive and control the vehicle.

⚠ CAUTION

- Leading Vehicle Departure Alert is a supplemental function and may not alert the driver whenever the front vehicle departs from a stop.
- Always check the front of the vehicle and road conditions before departure.

*** NOTICE**

The images or colors may be displayed differently depending on the specifications of the instrument cluster or theme.

Driver Attention Warning malfunction and limitations

Driver Attention Warning malfunction

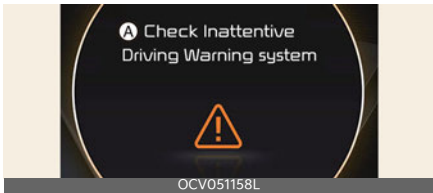

A: Check Inattentive Driving Warning system

When Driver Attention Warning is not working properly, the warning message will appear and (⚠) warning lights will illuminate on the cluster. If this occurs, have Driver Attention Warning be inspected by a professional workshop. Kia recommends visiting an authorized Kia dealer/service partner.

Limitations of Driver Attention Warning

Driver Attention Warning may not work properly in the following situations:

- The vehicle is driven violently
- The vehicle intentionally crosses over lanes frequently
- The vehicle is controlled by Driver Assistance system, such as Lane Keeping Assist

Leading vehicle departure alert function

- When the vehicle cuts in

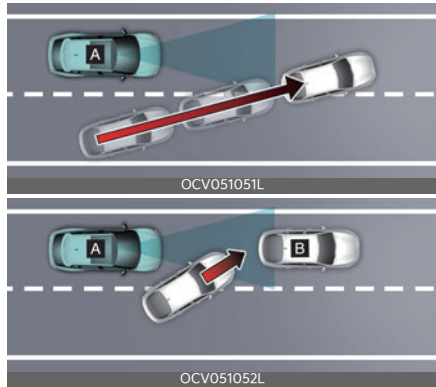

[A]: Your vehicle, [B]: Front vehicle

If a vehicle cuts in front of your vehicle, Leading Departure Alert may not operate properly.

- When the vehicle ahead sharply steers



[A]: Your vehicle, [B]: Front vehicle
If the vehicle in front makes a sharp turn, such as to turn left or right or make a U- turn, etc., Leading Vehicle Departure Alert may not operate properly.

- When the vehicle ahead abruptly departs

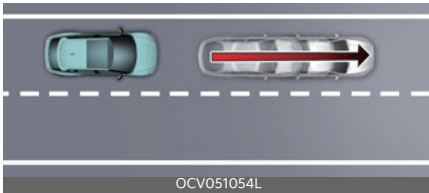

If the vehicle in front abruptly departs, Leading Vehicle Departure Alert may not operate properly.

- When a pedestrian or bicycle is between you and the vehicle ahead



If there is a pedestrian(s) or bicycle(s) in between you and the vehicle in front, Leading Vehicle Departure Alert may not operate properly.

- When in a parking lot



If a vehicle parked in front drives away from you, Leading Vehicle Departure Alert may alert you that the parked vehicle is driving away.

- When driving at a tollgate or intersection, etc.



If you pass a tollgate or intersection with lots of vehicles or you drive where lanes are merged or divided frequently, Leading Vehicle Departure Alert may not operate properly.

* NOTICE

For more details on the precautions of the front view camera, refer to "Forward Collision-Avoidance Assist (FCA) (if equipped)" on page 6-38.

Blind-Spot View Monitor (BVM) (if equipped)

Left side

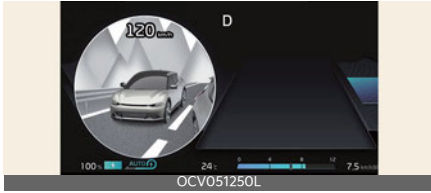

Right side

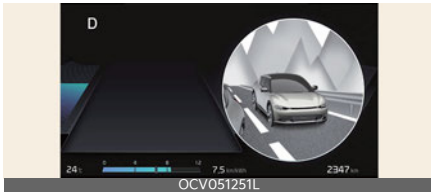

Blind-Spot View Monitor displays the rear blind spot area of the vehicle in the cluster when the turn signal is turned on to help safely change lanes.

Detecting sensor

SVM-side view camera



(camera located at bottom of the mirror)
Refer to the picture above for the detailed location of the detecting sensors.

Blind-Spot View Monitor settings

Blind-Spot View

With the vehicle on, select **Settings** → **Vehicle** → **Driver assistance** → **Blind-spot safety** → **Blind-spot view** from the infotainment system screen to turn on Blind-Spot View Monitor and deselect to turn off the function.

Blind-Spot View Monitor operation

Turn signal lever



Blind-Spot View Monitor will turn on and off when the turn signal is turned on and off.

Blind-Spot View Monitor

Operating conditions

- When the left or right turn signal turns on, the image on the instrument cluster will turn on.

Off conditions

Blind-Spot View Monitor will turn off when one of the following conditions are satisfied:

- When the turn signal is turned off.
- When the hazard warning flasher is on.
- When other important warning is displayed on the instrument cluster.

Blind-Spot View Monitor malfunction

When Blind-Spot View Monitor is not working properly, or the cluster display flickers, or the camera image does not display normally, have Blind-Spot View Monitor be inspected by a professional workshop. Kia recommends visiting an authorized Kia dealer/service partner.

⚠ WARNING

- The image shown on the cluster may differ from the actual distance of the object. Make sure to directly check the vehicle's surroundings for safety.
- If the camera lens is covered with foreign material, the Blind-Spot View Monitor may not operate normally. Always keep the camera lens clean. However, do not use chemical solvents such as strong detergents containing high alkaline or volatile organic solvents (gasoline, acetone etc.). This may damage the camera lens.

Cruise Control (CC) (if equipped)

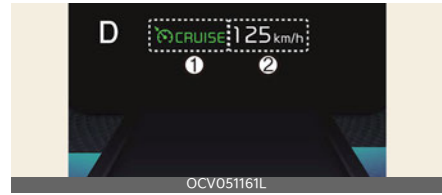

- 1 Cruise indicator
- 2 Set speed

Cruise Control will allow you to drive at speeds above 30 km/h (20 mph) without depressing the accelerator pedal.

Cruise Control operation

To set speed

1. Accelerate to the desired speed, which must be more than 30 km/h (20 mph).



2. Press the Driving Assist (Ⓜ) button at the desired speed. The set speed and Cruise (CRUISE) indicator will illuminate on the cluster.
3. Release the accelerator pedal. Vehicle speed will maintain the set speed even when The accelerator pedal must not be pressed.

*** NOTICE**

On a steep sloped road, the vehicle may slightly slow down or speed up while driving uphill or downhill.

To increase set speed



OCV051248L

- Push the + switch up and release it immediately. The set speed will increase by 1 km/h (1 mph) each time the switch is operated in this manner.
- Push the + switch up and hold it while monitoring the set speed on the cluster. The set speed will increase to the nearest multiple of ten (multiple of five in mph) at first, and then increase by 10 km/h (5 mph) each time the switch is operated in this manner.

Release the switch when the desired speed is shown and the vehicle will accelerate to that speed.

To decrease set speed



OCV051249L

- Push the - switch down and release it immediately. The set speed will decrease by 1 km/h (1 mph) each time the switch is operated in this manner.
- Push the - switch down and hold it while monitoring the set speed on the cluster. The set speed will decrease to the nearest multiple of ten (multiple of five in mph) at first, and then decrease by 10 km/h (5 mph) each time the switch is operated in this manner.

Release the switch at the speed you want to maintain.

To temporarily accelerate

If you want to speed up temporarily when Cruise Control is on, depress the accelerator pedal.

To return to the set speed, take your foot off the accelerator pedal.

If you push the + switch up or - switch down at increased speed, the cruising speed will be set to the current increased speed.

To temporarily pause Cruise Control



OCV051224L_2

Cruise Control will be paused when:

- Depressing the brake pedal.
- Pressing the (|||) button.
- Shifting the gear to N (Neutral).
- Decreasing vehicle speed to less than approximately 30 km/h (20 mph).
- Increasing vehicle speed to more than approximately 190 km/h (120 mph)
- Operating the electronic parking brake system **EPB**.
- ESC (Electronic Stability Control) is operating.

The set speed will turn off but the Cruise (CC) indicator will stay on.

* NOTICE

If Cruise Control pauses during a situation that is not mentioned, have the vehicle be inspected by a professional

workshop. Kia recommends visiting an authorized Kia dealer/service partner.

To resume Cruise Control



Push the +, - switch or (RES) button.

If you push the + switch up or - switch down, vehicle speed will be set to the current speed on the cluster.

If you press the (RES) button, vehicle speed will resume to the preset speed. Vehicle speed must be above 30 km/h (20 mph) for Cruise Control to resume.

⚠ WARNING

Check the driving condition before using the (RES) button. Driving speed may sharply increase or decrease when you press the (RES) button.

To turn off Cruise Control



Press the Driving Assist (DA) button to turn Cruise Control off. The Cruise (CRUISE) indicator will go off.

Always press the Driving Assist button to turn Cruise Control off when not in use.

* NOTICE

If your vehicle is equipped with Manual Speed Limit Assist, press and hold the

Driving Assist button to turn off Cruise Control. However, Manual Speed Limit Assist will turn on.

⚠ WARNING

Take the following precautions when using Cruise Control:

- Always set the vehicle speed under the speed limit in your country.
- Keep Cruise Control off when the function is not in use, to avoid inadvertently setting a speed. Check that the Cruise (CRUISE) indicator is off.
- Cruise Control does not substitute for proper and safe driving. It is the responsibility of the driver to always drive safely and should always be aware of unexpected and sudden situations from occurring.
- Always drive cautiously to prevent unexpected and sudden situations from occurring. Pay attention to the road conditions at all times.
- Do not use Cruise Control when it may be unsafe to keep the vehicle at a constant speed:
 - When driving in heavy traffic, or when traffic conditions make it difficult to drive at a constant speed
 - When driving on rainy, icy, or snow-covered roads
 - When driving on hilly or windy roads
 - When driving in windy areas
 - When driving with limited view (possibly due to bad weather, such as fog, snow, rain and sandstorm)
- Do not use Cruise Control when towing a trailer.

Smart Cruise Control (SCC) (if equipped)

Smart Cruise Control is designed to detect the vehicle ahead and help maintain the desired speed and minimum distance with the vehicle ahead.

Overtaking Acceleration Assist

While Smart Cruise Control is operating, if the function judges that the driver is determined to overtake the vehicle in front, acceleration will be assisted.

Based on Driving Style (if equipped)

Smart Cruise Control will operate based on the driver's driving style, such as inter-vehicle distance, acceleration, reaction speed.

Detecting sensor

Front view camera



Front radar



Front corner radar (if equipped)



The front view camera, front radar, and front corner radars (if equipped) are used as a detecting sensor to detect the vehicles in front.

Refer to the picture above for the detailed location of the detecting sensor.

⚠ CAUTION

- Always keep the front view camera and front radar in good condition to maintain optimal performance of Smart Cruise Control.
- For more details on the precautions of the front view camera and front radar, refer to "Forward Collision-Avoidance Assist (FCA) (if equipped)" on page 6-38.

Smart Cruise Control settings

Setting features

To turn on Smart Cruise Control



Press the Driving Assist (DA) button to turn on the function. The speed will be set to the current speed on the cluster.

- If there is no vehicle in front of you, the set speed will be maintained.

h (5 mph) each time the switch is operated in this manner.

- You can set the speed to 30 km/h (20 mph).

To temporarily cancel Smart Cruise Control



Press the (|||>) switch or depress the brake pedal to temporarily cancel Smart Cruise Control.

To resume Smart Cruise Control



To resume Smart Cruise Control after the function was canceled, push the +, - or (|||>) switch.

- If you push the + switch up or - switch down, vehicle speed will be set to the current speed on the cluster.
- If you push the (|||>) switch, vehicle speed will resume to the preset speed.

⚠ WARNING

Check the driving condition before using the (|||>) switch. Driving speed may sharply increase or decrease when you press the (|||>) switch.

To turn off Smart Cruise Control



Press the Driving Assist (⚠) button to turn Smart Cruise Control off.

* NOTICE

If your vehicle is equipped with Manual Speed Limit Assist, press and hold the Driving Assist (⚠) button to turn off Smart Cruise Control. However Manual Speed Limit Assist will turn on.

Based on Driving Mode

Smart Cruise Control will change acceleration based on the drive mode selected from Drive Mode Integrated Control function. Refer to the following chart.

Drive Mode	Smart Cruise Control
SNOW	Normal
ECO	Slow
SPORT	Fast
NORMAL	Normal

* NOTICE

- For more details on Drive Mode, refer to "Drive mode integrated control system" on page 6-32.
- Smart Cruise Control may not turn on or off in some of the drive modes for the operating conditions are not satisfied.
- If your vehicle is not equipped with Drive Mode Integrated Control system, Smart Cruise Control accelerates your vehicle at a normal level.

Based on driving style (if equipped)

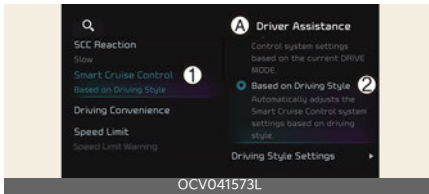

A: Driver assistance

1 SCC (Smart Cruise Control)

2 Based on driving style

With the vehicle on, if **Settings** → **Vehicle** → **Driver assistance** → **SCC (Smart Cruise Control)** → **Based on driving style** is selected from the infotainment system screen, Smart Cruise Control will operate based on the driver's driving style, such as vehicle distance, acceleration, reaction speed.

While Smart Cruise Control is operating with **Based on driving mode** selected, if you press and hold the Vehicle Distance (🚗) button, Smart Cruise Control will change to **Based on driving style**. While Smart Cruise Control is operating with **Based on driving style**, if the Vehicle Distance (🚗) button is pressed, it will change to **Based on driving mode**.

* NOTICE

- If equipped with Based on Driving Style, **Based on driving mode** and **Based on driving style** can be selected from the infotainment system screen by selecting **Settings** → **Vehicle** → **Driver assistance** → **SCC (Smart Cruise Control)**.
- If **Based on driving mode** is selected, Smart Cruise Control will operate based on the drive mode selected.
- While Smart Cruise Control is operating with **Based on driving style**

selected, if you press and hold the Vehicle Distance (🚗) button, Smart Cruise Control will change to **Based on driving mode**. Press and hold the Vehicle Distance (🚗) button to change Smart Cruise Control to **Based on driving style** mode.

View driving style analysis (if equipped)

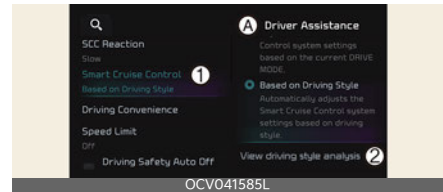

A: Driver assistance

1 SCC (Smart Cruise Control)

2 View driving style analysis

With the vehicle on, select **Settings** → **Vehicle** → **Driver assistance** → **SCC (Smart Cruise Control)** → **View driving style analysis** from the infotainment system screen to check the driver's driving style, and to change each driving style manually.

* NOTICE

- **View driving style analysis** is displayed when **Based on Driving Style** is selected.
- Smart Cruise Control learns the driver's driving styles only when the driver drives the vehicle.

Warning volume

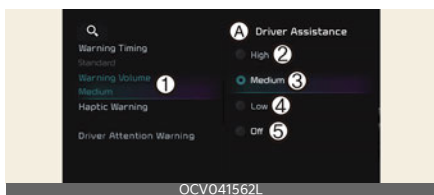

A: Driver assistance

1 Warning volume

2 High

3 Medium

4 Low

5 Off

With the vehicle on, select **Settings** → **Vehicle** → **Driver assistance** → **Warning volume** from the infotainment system screen to change the Warning Volume **High**, **Medium**, **Low** or **Off** for Smart Cruise Control.

However, even if **Off** is selected, the Warning Volume of Smart Cruise Control will not turn off but the volume will sound as **Low**.

If you change the Warning Volume, the warning volume of other Driver Assistance systems may change.

* NOTICE

If the vehicle is restarted, Warning Volume will maintain the last setting.

Smart Cruise Control operation

Operating conditions

Smart Cruise Control will operate when the following conditions are satisfied.

Basic function

- The gear is in D (Drive)
- The driver's door is closed

- EPB (Electronic Parking Brake) is not applied
- Your vehicle speed is within the operating speed range
 - When there is no vehicle in front: 10~180 km/h (5~110 mph)
 - when there is a vehicle in front: 0~180 km/h (0~110 mph)
- ESC (Electronic Stability Control) or ABS is on
- ESC (Electronic Stability Control) or ABS is not controlling the vehicle
- Forward Collision-Avoidance Assist brake control is not operating
- Remote Smart Parking Assist brake control is not operating (if equipped)
- The vehicle is not in a power down status (Power down indicator light is not illuminated)

* NOTICE

When stopped behind another vehicle, the driver can turn on Smart Cruise Control while the brake pedal is depressed.

Overtaking Acceleration Assist

Overtaking Acceleration Assist will operate when the turn signal indicator is turned on to the left (left-hand drive) or turned on to the right (right-hand drive) while Smart Cruise Control is operating, and the following conditions are satisfied:

- Your vehicle speed is above 60 km/h (40 mph)
- The hazard warning flasher is off
- A vehicle is detected in front of your vehicle
- Deceleration is not needed to maintain distance with the vehicle in front

WARNING

- When the turn signal indicator is turned on to the left (left-hand drive) or turned on to the right (right-hand drive) while there is a vehicle ahead, the vehicle may accelerate temporarily. Pay attention to the road conditions at all times.
- Regardless of your country's driving direction, Overtaking Acceleration Assist will operate when the conditions are satisfied. When using the function in countries with different driving direction, always check the road conditions at all times.

Smart Cruise Control display and control

Basic function

You can see the status of the Smart Cruise Control operation in the Driving Assist mode on the cluster. Refer to "Instrument cluster" on page 5-45.

Smart Cruise Control will be displayed as below depending on the status of the function.

- When operating



1. Whether there is a vehicle ahead and the selected distance level are displayed.
2. Set speed is displayed.
3. Whether there is a vehicle ahead and the selected target distance are displayed.

- When temporarily canceled



1. (SCC) indicator is displayed.
2. The previous set speed is shaded.

*** NOTICE**

- The distance of the front vehicle on the cluster is displayed according to the actual distance between your vehicle and the vehicle ahead.
- The target distance may vary according to the vehicle speed and the set distance level. If vehicle speed is low, even though the vehicle distance have changed, the change of the target vehicle distance may be small.

To temporarily accelerate



If you want to speed up temporarily without altering the set speed while Smart Cruise Control is operating, depress the accelerator pedal. While the accelerator pedal is depressed, the set speed, distance level and target distance will blink on the cluster.

However, if the accelerator pedal is depressed insufficiently, the vehicle may decelerate.

⚠ WARNING

Be careful when accelerating temporarily, because the speed and distance is not controlled automatically even if there is a vehicle in front of you.

Based on Driving Style operating (if equipped)



A: Driving Style Adaptive SCC

When Based on Driving Style is operating, the message will appear on the cluster for 2 seconds, and the distance level and target distance will be displayed based on the driving style.

Smart Cruise Control temporarily canceled

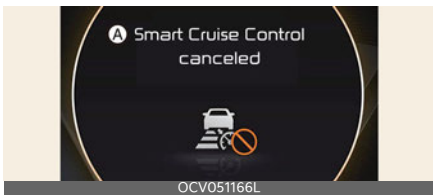

A: Smart Cruise Control canceled

Smart Cruise Control will be temporarily canceled automatically when:

- The vehicle speed is above 190 km/h (120 mph)
- The vehicle is stopped for a certain period of time
- The accelerator pedal is continuously depressed for a certain period of time
- The conditions for the Smart Cruise Control to operate is not satisfied

If Smart Cruise Control is temporarily canceled automatically, a warning message will appear on the cluster, and an audible warning will sound to warn the driver.

⚠ WARNING

When Smart Cruise Control is temporarily canceled, distance with the front vehicle will not be maintained. Always have your eyes on the road while driving, and if necessary, depress the brake pedal to reduce your driving speed in order to maintain a safe distance.

Smart Cruise Control conditions not satisfied

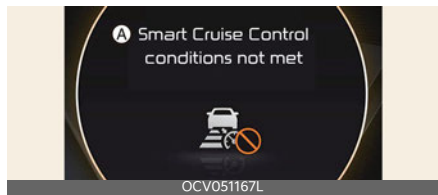

A: Smart Cruise Control conditions not met

If the Driving Assist button, + switch, - switch or (||) switch is pushed when Smart Cruise Control's operating conditions are not satisfied, a warning message will appear on the cluster, and an audible warning will sound.

In traffic situation



A: Use switch or pedal to accelerate

In traffic, your vehicle will stop if the vehicle ahead of you stops. Also, if the vehicle ahead of you starts moving, your vehicle will start as well.

In addition, after the vehicle has stopped and a certain time have passed, a warning message like above will appear on the cluster. Depress the accelerator pedal or push the + switch, - switch or (⏏) switch to start driving.

Warning road conditions ahead



A: Watch for surrounding vehicles

In the following situation, the warning message will appear on the cluster, and an audible warning will sound to warn the driver of road conditions ahead.

- The vehicle in front disappears when Smart Cruise Control is maintaining the distance with the vehicle ahead while driving below a certain speed.
- While the **Use switch or pedal to accelerate** message is displayed on the cluster, if there is no vehicle in front or the vehicle is far away from you, and the + switch, - switch or switch is pushed.

⚠ WARNING

Always pay attention to vehicles or objects that may suddenly appear in front of you, and if necessary, depress the brake pedal to reduce your driving speed in order to maintain a safe distance.

Collision warning



A: Collision Warning

While Smart Cruise Control is operating, when the collision risk with the vehicle ahead is high, a warning message will appear on the cluster, and an audible warning will sound to warn the driver. Always have your eyes on the road while driving, and if necessary, depress the brake pedal to reduce your driving speed in order to maintain a safe distance.

⚠ WARNING

In the following situations, Smart Cruise Control may not warn the driver of a collision.

- The distance from the front vehicle is near, and the vehicle speed of the front vehicle is faster or similar with your vehicle
- The speed of the front vehicle is very slow or is at a standstill
- The accelerator pedal is depressed right after Smart Cruise Control is turned on

WARNING

Take the following precautions when using Smart Cruise Control:

- Smart Cruise Control does not substitute for proper and safe driving. It is the responsibility of the driver to always check the speed and distance to the vehicle ahead.
- Smart Cruise Control may not detect unexpected and sudden situations or complex driving situations, so always pay attention to driving conditions and control your vehicle speed.
- Keep Smart Cruise Control off when the function is not in use to avoid inadvertently setting a speed.
- Do not open the door when Smart Cruise Control is operating, even if the vehicle is stopped.
- Always be aware of the selected speed and vehicle to vehicle distance.
- Keep a safe distance according to road conditions and vehicle speed. If the vehicle to vehicle distance is too close during high-speed driving, a serious collision may result. Always pay attention to the road condition ahead.
- When maintaining distance with the vehicle ahead, if the front vehicle disappears, the function may suddenly accelerate to the set speed. Always be aware of unexpected and sudden situations from occurring.
- Vehicle speed may decrease on an upward sloped road and increase on a downward sloped road.
- Always be aware of situations such as when a vehicle cuts in suddenly.
- When you are towing a trailer or another vehicle, we recommend that Smart Cruise Control is turned off due to safety reasons.
- Turn off Smart Cruise Control when your vehicle is being towed.
- Smart Cruise Control may be canceled if interfered by strong electromagnetic waves.
- Smart Cruise Control may not detect an obstacle in front and lead to a collision. Always look ahead cautiously to prevent unexpected and sudden situations from occurring.
- Vehicles moving in front of you with a frequent lane change may cause a delay in the function's reaction or may cause the function to react to a vehicle actually in an adjacent lane. Always drive cautiously to prevent unexpected and sudden situations from occurring.
- Always be aware of the surroundings and drive safely, even though a warning message does not appear or an audible warning does not sound.
- If any other function's warning message is displayed or warning sound is generated, Smart Cruise Control warning message may not be displayed and warning sound may not be generated.
- You may not hear the warning sound of Smart Cruise Control if the surrounding is noisy. Always pay attention to the road condition ahead.
- The vehicle manufacturer is not responsible for any traffic violation or accidents caused by the driver while Smart Cruise Control is operating.
- Always set the vehicle speed under the speed limit in your country.
- Vehicle distance, acceleration and reaction speed may change if the driver's driving style changes. Always

pay attention to the road condition ahead.

⚠ CAUTION

- The vehicle must be driven sufficiently to reflect the actual driving style of the driver, such as vehicle distance, acceleration and reaction speed.
- Based on Driving Style may not reflect the driver's driving style or driving conditions that affects driving safety.
- If you are driving in special conditions, such as snow, rain, fog or steep sloped roads, the vehicle may not be driven according to the driver's driving style.

*** NOTICE**

- Smart Cruise Control may not operate for 15 seconds after the vehicle is restarted or the front view camera or front radar is initialized.
- You may hear a sound when the brake is controlled by Smart Cruise Control.
- Based on Driving Style may not reflect the driver's driving style that is not safe such as rapid acceleration.
- Based on Driving Style does not reflect any other driving style other than vehicle distance, acceleration and reaction speed.
- The paddle shifter does not operate when Smart Cruise Control is activated.

*** NOTICE**

The images or colors may be displayed differently depending on the specifications of the instrument cluster or theme.

Smart Cruise Control malfunction and limitations

Smart Cruise Control malfunction

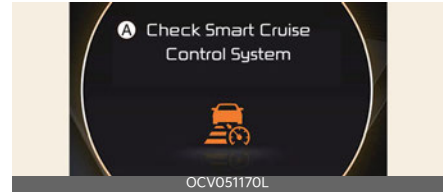

A: Check Smart Cruise Control System

When Smart Cruise Control is not working properly, a warning message will appear, and the (⚠) warning light will illuminate on the cluster. Have Smart Cruise Control be inspected by a professional workshop. Kia recommends visiting an authorized Kia dealer/service partner.

Smart Cruise Control disabled

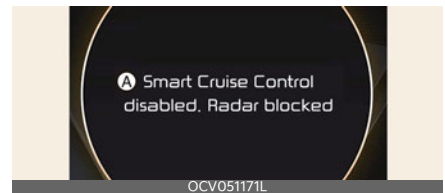

A: Smart Cruise Control disabled. Radar blocked

When the front radar cover or sensor is covered with snow, rain, or foreign material, it can reduce the detecting performance and temporarily limit or disable Smart Cruise Control.

If this occurs, a warning message will appear on the cluster.

Smart Cruise Control will operate normally when snow, rain or foreign material is removed.

⚠ WARNING

Even though the warning message does not appear on the cluster, Smart Cruise Control may not properly operate.

⚠ CAUTION

Smart Cruise Control may not properly operate in an area (e.g. open terrain), where there is nothing to detect after turning ON the vehicle.

Limitations of Smart Cruise Control

Smart Cruise Control may not operate normally under the following circumstances:

- The detecting sensor or the surroundings are contaminated or damaged
- Washer fluid is continuously sprayed, or the wiper is on
- The camera lens is contaminated due to tinted, filmed or coated windshield, damaged glass, or stuck of foreign material (sticker, bug, etc.) on the glass
- Moisture is not removed or frozen on the windshield
- The field of view of the front view camera is obstructed by sun glare
- Street light or light from an oncoming vehicle is reflected on the wet road surface, such as a puddle on the road
- The temperature around the front view camera is high or low
- An object is placed on the dashboard
- The surrounding is very bright
- The surrounding is very dark, such as in a tunnel, etc.
- The brightness changes suddenly, for example when entering or exiting a tunnel
- The brightness outside is low, and the headlamps are not on or are not bright
- Driving in heavy rain or snow, or thick fog
- Driving through steam, smoke or shadow
- Only part of the vehicle is detected
- The vehicle in front has no tail lights, tail lights are located unusually, etc.
- The brightness outside is low, and the tail lamps of the vehicle in front are not on or are not bright
- The rear of the front vehicle is small or does not look normal (i.e. tilted, overturned, etc.)
- The front vehicle's ground clearance is low or high
- A vehicle suddenly cuts in front
- Your vehicle is being towed
- Driving through a tunnel or iron bridge
- Driving near areas containing metal substances, such as a construction zone, railroad, etc.
- A material is near that reflects very well on the front radar, such as a guardrail, nearby vehicle, etc.
- The bumper around the front radar is impacted, damaged or the front radar is out of position
- The temperature around the front radar is high or low
- Driving in large areas where there are few vehicles or structures (i.e. desert, meadow, suburb, etc.)
- The vehicle in front is made of material that does not reflect on the front radar
- Driving near a highway (or motorway) interchange or tollgate

- Driving on a slippery surface due to snow, water puddle, ice, etc.
- Driving on a curved road
- The vehicle in front is detected late
- The vehicle in front is suddenly blocked by an obstacle
- The vehicle in front suddenly changes lane or suddenly reduces speed
- The vehicle in front is bent out of shape
- The front vehicle's speed is fast or slow
- With a vehicle in front, your vehicle changes lane suddenly at low speed
- The vehicle in front is covered with snow
- Unstable driving
- You are on a roundabout and the vehicle in front is not detected
- You are continuously driving in a circle
- Driving in a parking lot
- Driving through a construction area, unpaved road, partial paved road, uneven road, speed bumps, etc.
- Driving on an incline road, curved road, etc.
- Driving through a roadside with trees or streetlights
- The adverse road conditions cause excessive vehicle vibrations while driving
- Your vehicle height is low or high due to heavy loads, abnormal tire pressure, etc.
- Driving through a narrow road where trees or grass are overgrown
- There is interference by electromagnetic waves, such as driving in an area with strong radio waves or electrical noise

- Driving on a curved road



On curved roads, Smart Cruise Control may not detect a vehicle in the same lane, and may accelerate to the set speed. Also, vehicle speed may rapidly decrease when the vehicle ahead is detected suddenly.

Select the appropriate set speed on curved roads and apply the brake pedal or accelerator pedal according to the road and driving conditions ahead.



Your vehicle speed can be reduced due to a vehicle in the adjacent lane. Check to be sure that the road conditions permit safe operation of the Smart Cruise Control and if necessary, depress the brake pedal to reduce your driving speed in order to maintain a safe distance.

- Driving on a sloped road



During uphill or downhill driving, the Smart Cruise Control may not detect a

moving vehicle in your lane, and cause your vehicle to accelerate to the set speed. Also, vehicle speed will rapidly decrease when the vehicle ahead is detected suddenly.

Select the appropriate set speed on sloped roads and apply the brake pedal or accelerator pedal according to the road and driving conditions ahead.

- Changing lanes



[A]: Your vehicle

[B]: Lane changing vehicle

When a vehicle moves into your lane from an adjacent lane, it cannot be detected by the sensor until it is in the sensor's detection range. Smart Cruise Control may not immediately detect the vehicle when the vehicle changes lanes abruptly. Always pay attention to the road and driving conditions and drive safely. If necessary, depress the brake pedal to reduce your driving speed in order to maintain a safe distance.

- Detecting a vehicle



In the following cases, some vehicles in your lane cannot be detected by the sensor:

- Vehicles offset to one side

- Slow-moving vehicles or sudden-decelerating vehicles
- Vehicles that has the front lifted due to heavy loads
- Oncoming vehicles
- Stopped vehicles
- Vehicles with small rear profile, such as trailers
- Narrow vehicles, such as motorcycles or bicycles
- Special vehicles
- Animals and pedestrians



OCV051032L_2

In the following cases, the vehicle in front cannot be detected by the sensor. Always pay attention to the road and driving conditions and drive safely. If necessary, adjust your vehicle speed.

- Vehicles with higher ground clearance or vehicles carrying loads that stick out of the back of the vehicle
- Vehicles that has the front lifted due to heavy loads
- You are steering your vehicle
- Driving on narrow or sharply curved roads



OCV051064L

- When a vehicle ahead disappears at an intersection, your vehicle may accelerate.
Always pay attention to road and driving conditions while driving.



OCV051065L

- When a vehicle in front of you merges out of the lane, Smart Cruise Control may not immediately detect the new vehicle that is now in front of you.
Always pay attention to road and driving conditions while driving.



OCV051066L

- Always look out for pedestrians when your vehicle is maintaining a distance with the vehicle ahead.

Navigation-based Smart Cruise Control (NSCC) (if equipped)

Navigation-based Smart Cruise Control will help automatically adjust vehicle speed when driving on highways (or motorways) by using road information from the navigation function while Smart Cruise Control is operating.

* NOTICE

- Navigation-based Smart Cruise Control is available only on controlled access road of certain highways.
 - * Controlled access road indicates roads with limited entrances and exits that allow uninterrupted high speed traffic flow. Only passenger cars and motorcycles are allowed on controlled access roads.
- Additional highways may be expanded by future navigation updates.

* NOTICE

Navigation-based Smart Cruise Control operates on main roads of highways (or motorways), and does not operate on interchanges or junctions.

⚠ WARNING

Navigation-based Smart Cruise Control is a supplemental function and is not a substitute for safe driving. It is the responsibility of the driver to always check the speed and distance to the vehicle ahead. Always drive safely and use caution.

Highway Curve Zone Auto Slow-down

If vehicle speed is high, Highway Curve Zone Auto Slowdown function will temporarily decelerate your vehicle or limit acceleration to help you drive safely on a curve based on the curve information from the navigation.

Highway Set Speed Auto Change

Highway Set Speed Auto Change function automatically changes Smart Cruise Control set speed based on the speed limit information from the navigation.

Navigation-based Smart Cruise Control settings

Setting features

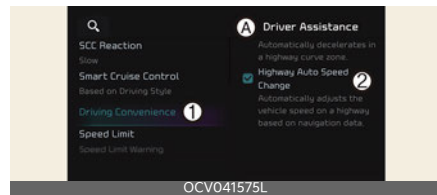

A: Driver assistance

1 Driving convenience

2 Highway Auto Speed Change

With the vehicle on, select **Settings** → **Vehicle** → **Driver assistance** → **Driving Convenience** → **Highway Auto Speed Change** from the infotainment system screen to turn on Navigation-based Smart Cruise Control and deselect to turn off the function.

* NOTICE

When there is a problem with Navigation-based Smart Cruise Control, the function cannot be set from the Settings menu.

Navigation-based Smart Cruise Control operation

Operating conditions

Navigation-based Smart Cruise Control is ready to operate if all of the following conditions are satisfied:

- Smart Cruise Control is operating
- Driving on main roads of highways (or motorways)

* NOTICE

For more details on how to operate Smart Cruise Control, refer to "Smart Cruise Control (SCC) (if equipped)" on page 6-98.

Navigation-based Smart Cruise Control display and control

When Navigation-based Smart Cruise Control operates, it will be displayed on the cluster as follows:

Navigation-based Smart Cruise Control standby



If the operating conditions are satisfied, the white (NAV) symbol will illuminate.

Navigation-based Smart Cruise Control operating

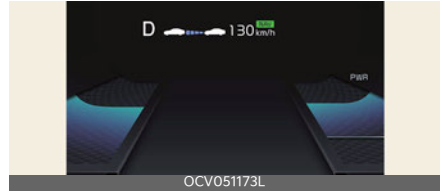

If temporary deceleration is required in the standby state and Navigation-based Smart Cruise Control is operating, the green (NAV) symbol will illuminate on the cluster.

If the Highway Set Speed Auto Change function operates, the green (NAV) symbol and set speed will illuminate on the cluster, and an audible warning will sound.

⚠ WARNING

The warning message will appear in the following circumstances:



A: Drive carefully

- Navigation-based Smart Cruise Control is not able to slow down your vehicle to a safe speed.

* NOTICE

Highway Curve Zone Auto Slowdown and Set Speed Auto Change function uses the same (NAV) symbol.

Highway Curve Zone Auto Slow-down

- Depending on the curve ahead on the highway (or motorway), the vehicle will decelerate, and after passing the curve, the vehicle will accelerate to Smart Cruise Control set speed.
- Vehicle deceleration time may differ depending on the vehicle speed and the degree of the curve on the road. The higher the driving speed, deceleration will start faster.

Highway Set Speed Auto Change

- Highway Set Speed Auto Change function will operate when Smart Cruise Control set speed and the highway (or motorway) speed limit is matched.
- While Highway Set Speed Auto Change function is operating, when the highway (or motorway), speed limit changes, Smart Cruise Control set speed automatically changes to the changed speed limit.
- If Smart Cruise Control set speed is adjusted different from the speed limit, Highway Set Speed Auto Change function will be in the standby state.
- If Highway Set Speed Auto Change function has changed to the standby state by driving on a road other than the highway (or motorway) main road, Highway Set Speed Auto Change function will operate again when you drive on the main road again without setting the set speed.
- If Highway Set Speed Auto Change function has changed to the standby state by depressing the brake pedal, press the (⏏) switch to restart the function.

- Highway Set Speed Auto Change function does not operate on highway interchanges or junctions.

* NOTICE

- Highway Set Speed Auto Change function only operates based on the speed limits of the highway (or motorway), it does not work with the speed cameras.
- When Highway Set Speed Auto Change function is operating, the vehicle automatically accelerates or decelerates when the highway (or motorway) speed limit changes.
- The maximum set speed for Highway Set Speed Auto Change function is 140 km/h (90 mph).
- If the speed limit of a new road is not updated in the navigation, Highway Set Speed Auto Change function may not operate properly.
- If the speed unit is set to a unit other than the speed unit used in your country, Highway Set Speed Auto Change function may not operate properly.

* NOTICE

The images or colors may be displayed differently depending on the specifications of the instrument cluster or theme.

Navigation-based Smart Cruise Control limitations

Navigation-based Smart Cruise Control may not operate normally under the following circumstances:

- The navigation is not working properly

- Map information is not transmitted due to infotainment system's abnormal operation
- Speed limit and road information in the navigation is not updated
- The map information and the actual road is different because of real-time GPS data or map information error
- The navigation searches for a route while driving
- GPS signals are blocked in areas such as a tunnel
- A road that divides into two or more roads and joins again
- The driver goes off course the route set in the navigation
- The route to the destination is changed or canceled by resetting the navigation
- The vehicle enters a service station or rest area
- Android Auto or Car Play is operating
- The navigation cannot detect the current vehicle position (ex: elevated roads including overpass adjacent to general roads or nearby roads exist in a parallel way)
- The navigation is being updated while driving
- The navigation is being restarted while driving
- The speed limit of some sections changes according to the road situations
- Driving on a road under construction
- Driving on a road that is controlled
- There is bad weather, such as heavy rain, heavy snow, etc.
- Driving on a road that is sharply curved

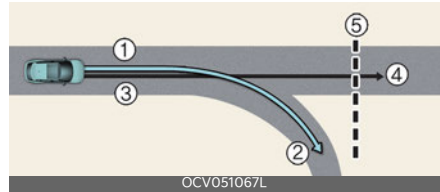

[1]: Set route, [2]: Branch line, [3]: Driving route, [4]: Main road, [5]: Curved road section

- When there is a difference between the navigation set route (branch line) and the driving route (main road), Highway Curve Zone Auto Slowdown function may not operate until the driving route is recognized as the main road.
- When the vehicle's driving route is recognized as the main road by maintaining the main road instead of the navigation set route, Highway Curve Zone Auto Slowdown function will operate. Depending on the distance to the curve and the current vehicle speed, vehicle deceleration may not be sufficient or may decelerate rapidly.



[1]: Main road, [2]: Branch line, [3]: Driving route, [4]: Set route, [5]: Curved road section

- When there is a difference between the navigation route (main road) and the driving route (branch line), Highway Curve Zone Auto Slowdown function will operate temporarily based on the curve information on the main road.

- When it is judged that you are driving out of the route by entering the highway interchange or junction, Highway Curve Zone Auto Slowdown function will not operate.

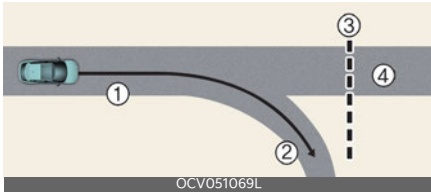

[1]: Driving route, [2]: Branch line, [3]: Curved road section, [4]: Main road

- If there is no destination set on the navigation, Highway Curve Zone Auto Slowdown function will operate based on the curve information on the main road.
- Even if you depart from the main road, Highway Curve Zone Auto Slowdown function may temporarily operate due to navigation information of the highway curve section.
- Navigation-based Smart Cruise Control may not operate due to the existence of leading vehicles and the driving conditions of the vehicle. Always pay attention to road and driving conditions while driving.
- When you are towing a trailer or another vehicle, we recommend that Navigation-based Smart Cruise Control is turned off due to safety reasons.
- After you pass through a tollgate on a highway (or motorway), Navigation-based Smart Cruise Control will operate based on the first lane. If you enter one of the other lanes, the function might not operate properly.
- The vehicle will accelerate if the driver depresses the accelerator pedal while Navigation-based Smart Cruise Control is operating, and the function will not decelerate the vehicle. However, if the accelerator pedal is depressed insufficiently, the vehicle may decelerate.
- If the driver accelerates and releases the accelerator pedal while Navigation-based Smart Cruise Control is operating, the vehicle may not decelerate sufficiently or may rapidly decelerate to a safe speed.
- If the curve is too large or too small, Navigation-based Smart Cruise Control may not operate.

⚠ WARNING

- Navigation-based Smart Cruise Control is not a substitute for safe driving practices, but a convenience function. Always have your eyes on the road, and it is the responsibility of the driver to avoid violating traffic laws.
- The navigation's speed limit information may differ from the actual speed limit information on the road. It is the driver's responsibility to check the speed limit on the actual driving road or lane.
- Navigation-based Smart Cruise Control will automatically be canceled when you leave the highway (or motorway) main road. Always pay attention to road and driving conditions while driving.

*** NOTICE**

- The speed information on the cluster and navigation may differ.
- The time gap could occur between the navigation's guidance and when Navigation-based Smart Cruise Control operation starts and ends.
- Even if you are driving at a speed lower than Smart Cruise Control set speed, acceleration may be limited by the curve sections ahead.
- If Navigation-based Smart Cruise Control is operating while leaving the main road to enter an interchange, junction, rest area, etc., the function may operate for a certain period of time.
- Deceleration by Navigation-based Smart Cruise Control may feel it is not sufficient due to road conditions such as uneven road surfaces, narrow lanes, etc.

Lane Following Assist (LFA)

Lane Following Assist is designed to help detect lane markings and/or vehicles on the road, and assists the driver's steering to help keep the vehicle between lanes.

Detecting sensor

Front view camera



The front view camera is used as a detecting sensor to detect lane markings and front vehicles.

Refer to the picture above for the detailed location of the detecting sensor.

⚠ CAUTION

For more details on the precautions of the front view camera, refer to "Forward Collision-Avoidance Assist (FCA) (if equipped)" on page 6-38.

Lane Following Assist settings

Setting features

Turning Lane Following Assist On/Off



With the vehicle on, shortly press the Lane Driving Assist button located on the steering wheel to turn on Lane Following Assist. The gray or green (ⓐ) indicator light will illuminate on the cluster.

Press the button again to turn off the function.

Warning volume

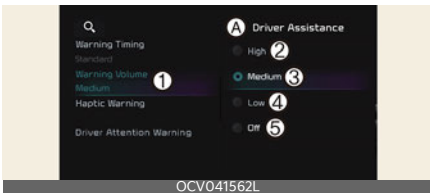

A: Driver assistance

1 Warning volume

2 High

3 Medium

4 Low

5 Off

With the vehicle on, select **Settings** → **Vehicle** → **Driver assistance** → **Warning volume** from the infotainment system screen to change the Warning Volume to **High**, **Medium**, **Low** or **Off** for Hands-off warning.

However, even if **Off** is selected, the Hands-off Warning Volume will not turn off but the volume will sound as **Low**.

If you change the Warning Volume, the warning volume of other Driver Assistance systems may change.

Lane Following Assist operation

Warning and control

Lane Following Assist

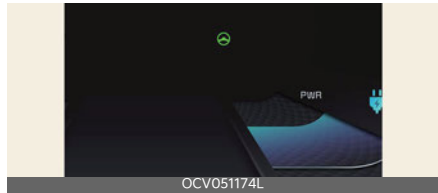

If the vehicle ahead and/or both lane markings are detected and your vehicle speed is below 180 km/h (110 mph), Lane Following Assist will help center the vehicle in the lane by assisting the steering wheel. The green (ⓐ) indicator light will illuminate on the cluster.

⚠ CAUTION

When the steering wheel is not assisted, the green (ⓐ) indicator light will blink and change to grey.

Hands-off warning



A: Keep hands on steering wheel

If the driver takes their hands off the steering wheel for several seconds, the

warning message will appear and an audible warning will sound in stages.

- First stage: Warning message
- Second stage: Warning message (red steering wheel) and audible warning

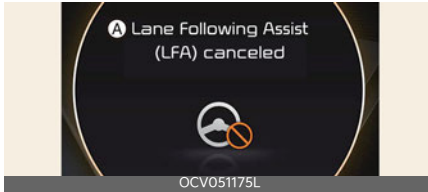

A: Lane Following Assist (LFA) canceled

If the driver still does not have their hands on the steering wheel after the hands-off warning, the warning message will appear and Lane Following Assist will be automatically canceled.

⚠ WARNING

- The steering wheel may not be assisted if the steering wheel is held very tight or the steering wheel is steered over a certain degree.
- Lane Following Assist does not operate at all times. It is the responsibility of the driver to safely steer the vehicle and to maintain the vehicle in its lane.
- The hands-off warning message may appear late depending on road conditions. Always have your hands on the steering wheel while driving.
- If the steering wheel is held very lightly the hands-off warning message may appear because Lane Following Assist may not detect that the driver has their hands on the steering wheel.
- If you attach objects to the steering wheel, the hands-off warning may not work properly.

* NOTICE

- For more details on setting Lane Following Assist in the infotainment system, refer to Navigation Quick Reference Guide.
- When both lane markings are detected, the lane lines on the cluster will change from grey to white.

Lane undetected

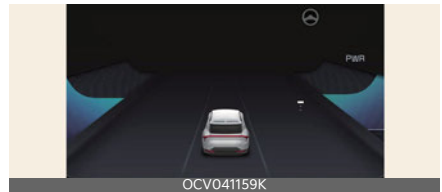

Lane detected

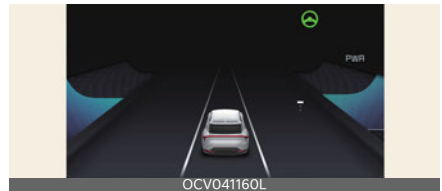

- The images and colors in the cluster may differ depending on the cluster type or theme selected from the cluster.
- If lane markings are not detected, steering wheel control by Lane Following Assist can be limited depending on whether a vehicle is in front or the driving conditions of the vehicle.
- Even though the steering is assisted by Lane Following Assist, the driver may control the steering wheel.
- The steering wheel may feel heavier or lighter when the steering wheel is assisted by Lane Following Assist than when it is not.

Lane Following Assist malfunction and limitations

Lane Following Assist malfunction

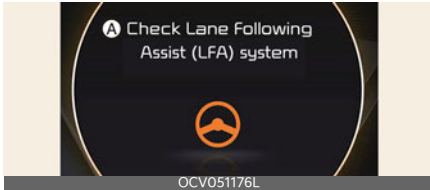

A: Check Lane Following Assist (LFA) system

When Lane Following Assist is not working properly, the warning message will appear and the master warning light (⚠) will illuminate on the cluster. If this occurs, have Lane Following Assist be inspected by a professional workshop. Kia recommends visiting an authorized Kia dealer/service partner.

Limitations of Lane Following Assist

⚠ WARNING

For more details on Lane Following Assist precautions, refer to "Lane Keeping Assist (LKA) (if equipped)" on page 6-57.

Highway Driving Assist (HDA) (if equipped)

Basic function

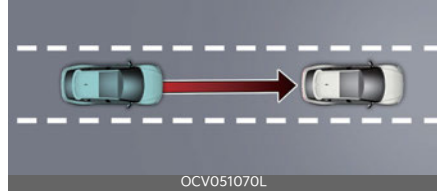

Highway Driving Assist is designed to help detect vehicles and lanes ahead, and help maintain distance from the vehicle ahead, maintain the set speed, and keep the vehicle between lanes while driving on the highway (or motorway).

Highway Lane Change Assist (if equipped)

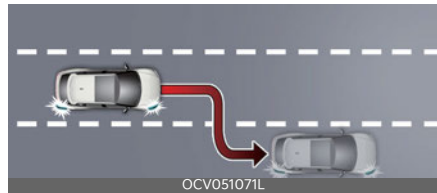

Highway Lane Change Assist function helps change lanes to the direction the driver slightly moves the turn signal switch if the function judges that lane change is possible.

*** NOTICE**

- Highway Driving Assist is available only on controlled access road of certain highways. (except for the interchange/junction)
 - * Controlled access road indicates roads with limited entrances and exits that allow uninterrupted high speed traffic flow. Only passenger

cars and motorcycles are allowed on controlled access roads.

- Additional highways may be expanded by future navigation updates.

Detecting sensor

Front view camera



Front radar



Front corner radar (if equipped)



Rear corner radar



Refer to the picture above for the detailed location of the detecting sensors.

CAUTION

For more details on the precautions of the detecting sensors, refer to "Forward Collision-Avoidance Assist (FCA) (if equipped)" on page 6-38.

Highway Driving Assist settings

Setting features

Basic function

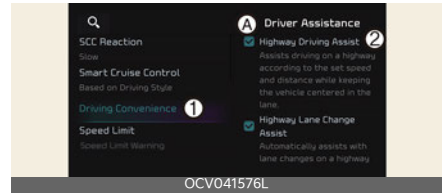

A: Driver assistance

1 Driving convenience

2 HDA (Motorway Driving Assist)

With the vehicle on, select or deselect **Settings** → **Vehicle** → **Driver assistance** → **Driving Convenience** from the infotainment system screen to set whether or not to use each function.

- If "**HDA (Motorway Driving Assist)**" is selected, it helps maintain distance from the vehicle ahead, maintain the set speed, and helps center the vehicle in the lane.

Highway Lane Change Assist (if equipped)

If **Lane change assist (motorway)** is selected, it helps the driver change lanes.

*** NOTICE**

- When "HDA (Motorway Driving Assist)" is deselected, the setting for Lane change assist (motorway) cannot be changed.
- If there is a problem with the functions, the settings cannot be changed. Have the function be inspected by an authorized Kia dealer/service partner.
- If the vehicle is restarted, the functions will maintain the last setting.

⚠ WARNING

For your safety, change the Settings after parking the vehicle at a safe location.

Warning volume



A: Driver assistance

- 1 Warning volume
- 2 High
- 3 Medium
- 4 Low
- 5 Off

With the vehicle on, select **Settings** → **Vehicle** → **Driver assistance** → **Warning volume** from the infotainment system screen to change the Warning Volume to **High, Medium, Low** or **Off** for Highway Driving Assist.

However, even if **Off** is selected, the Warning Volume will not turn off but the volume will sound as **Low**.

If you change the Warning Volume, the Warning Volume of other Driver Assistance systems may change.

Highway Driving Assist operation

Basic function

Highway Driving Assist display and control

You can see the status of the Highway Driving Assist operation in the Driving Assist view on the cluster. Refer to "LCD display" on page 5-47.

Highway Driving Assist will be displayed as below depending on the status of the function.

Operating State



Standby State



1 Highway Driving Assist indicator, whether there is a vehicle ahead and the selected distance level are displayed.

- Highway Driving Assist indicator
 - Green: Operating state
 - Grey: Standby state
 - White blink: Accelerator depressed state

2 Set speed is displayed.

- 3 Lane Following Assist indicator displayed.
- 4 Whether there is a vehicle ahead and the target vehicle to vehicle distance are displayed.
- 5 Whether the lane is detected or not is displayed.

* NOTICE

- For more details on the display, refer to "Smart Cruise Control (SCC) (if equipped)" on page 6-98.
- For more details on the display, refer to "Lane Following Assist (LFA)" on page 6-117.

Highway Driving Assist operating

When driving on available road, press Drive Assist button to turn on Highway Driving Assist.

Highway Driving Assist will operate when entering or driving on the main road of highways (or motorways), and satisfying all the following conditions:

- Lane Following Assist is operating
- Smart Cruise Control is operating

* NOTICE

- While driving on the highway (or motorway), if Smart Cruise Control starts operating, Highway Driving Assist will operate.
- When entering the main roads of highways (or motorways) while Smart Cruise Control is operating, Driving Assist will not turn on if Lane Following Assist is turned off.

Restarting after stopping

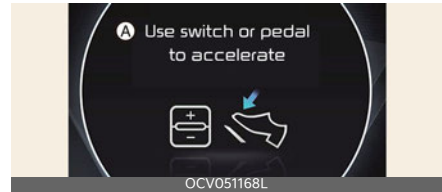

A: Use switch or pedal to accelerate

When Highway Driving Assist is operating, your vehicle will stop if the vehicle ahead of you stops. Also, if the vehicle ahead of you starts moving approximately within 30 seconds after the stop, your vehicle will start as well. In addition, after the vehicle has stopped and approximately 30 seconds have passed, the **Use switch or pedal to accelerate** message will appear on the cluster. Depress the accelerator pedal or push the + switch, - switch or (|||) switch to start driving.

Hands-off warning



A: Keep hands on steering wheel

If the driver takes their hands off the steering wheel for several seconds, the warning message will appear and an audible warning will sound in stages.

- First stage: Warning message
- Second stage: Warning message (red steering wheel) and audible warning



A: Highway Driving Assist (HDA) system canceled

If the driver still does not have their hands on the steering wheel after the hands-off warning, the warning message will appear and Highway Driving Assist and Lane Change Assist will be automatically canceled.

Driving speed limit



A: Driver's grasp not detected. Driving speed will be limited

When Highway Driving Assist is canceled by the hands-off warning, The driving speed will be limited. While Driving Speed Limit function is operating, the warning message will appear on the cluster, and an audible warning will sound continuously.

Driving to one side within lane (if equipped)

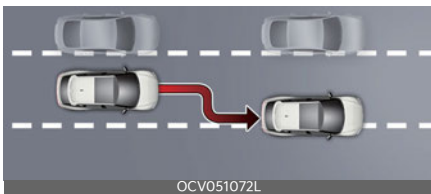

When vehicle speed is above 60 km/h (40 mph), if a vehicle around you is driv-

ing at a close distance, your vehicle will control steering in the opposite direction of the vehicle to assist in safe driving. If there are vehicles in both sides of the lane that are driving close to you, the function will not veer to the opposite side of the lane.

Highway Driving Assist standby

When the Smart Cruise Control is temporarily canceled while Highway Driving Assist is operating, Highway Driving Assist will be in the standby state. At this time, Lane Following Assist will operate normally.

*** NOTICE**

- Driving Speed Limit helps you drive below 60 km/h (40 mph). At this time, the vehicle decelerates due to the vehicle ahead. After the vehicle has decelerated, it cannot automatically accelerate.
- Driving Speed Limit will cancel in the following circumstances:
 - When the driver grabs the steering wheel again
 - When the driver turns on Lane Following Assist by pressing the Lane Driving Assist button
 - When Smart Cruise Control switch +, -, or (||) switch is pushed, or the accelerator pedal or the brake pedal is depressed

Highway Lane Change Assist (if equipped)

Display and control

You can see the status of the Highway Lane Change Assist function operation in the Driving Assist view on the cluster. Refer to "LCD display" on page 5-47.

Highway Lane Change Assist function will be displayed as below depending on the status of the function.

Ready/Operating



Standby/Canceled



- 1 Highway Lane Change Assist indicator
 - Green (↔↔) on: Ready state
 - Green (↔↔) blink: Operating state
 - Grey (↔↔) on: Standby state
 - White (↔↔) blink: Canceled state (display only a certain time)
- 2 Lane line

The lane line is displayed identical to Highway Lane Change Assist indicator (1). However, the lane detection availability will be showed on Standby state.
- 3 Green arrow and shade

The green arrow is displayed when a certain amount of time has passed after the function has started operating, and until the lane change has completed.
- 4 Message
 - Message is displayed when the function does not operate even though the turn signal lever is used.

- Message is displayed when the function is canceled while operating.

To turn on Highway Lane Change Assist



A: Press OK button to enable Lane Change Assist

1 Confirm

Highway Lane Change Assist function will turn on when the following conditions are satisfied.

- The Driving Assist button or Lane Driving Assist button is used to turn on Highway Driving Assist.
- The OK button is pressed on the steering wheel while a message asking to use Highway Lane Change Assist is displayed on the cluster.

Highway Lane Change Assist ready to operate

While Highway Lane Change Assist function is on, the function will be ready to operate when all the following conditions are satisfied:

- Highway Driving Assist is operating
- Lane Following Assist is operating
- A vehicle in the rear area of your vehicle is detected more than once after the vehicle is turned on
- Your vehicle speed is above 80 km/h (50 mph)
- Hands-off warning is not displayed on the cluster
- Hazard warning flasher is off

*** NOTICE**

- While Lane Change Assist function is turned on (indicator on), Lane Following Assist will not cancel even if the turn signal indicator or hazard warning flasher is operating.
- Lane Change Assist function turns off automatically when driven in the following road conditions:
 - One driving lane
 - A road with no structure, such as a medium strip, guardrails, etc.
 - There is a pedestrian or cyclist on the road ahead
- When the function is in the ready state, and vehicle speed is below 75 km/h (45 mph), the function will change to the standby state.

⚠ WARNING

When Highway Lane Change Assist function turns off while operating, steering assist will be temporarily canceled. Always be cautious while driving.

Highway Lane Change Assist operating



Highway Lane Change Assist function will operate, when you push the turn signal lever up or down while the function is in the ready state (() indicator is green), and all of the following conditions are satisfied:

- The driver has his/her hand on the steering wheel

- There is no collision risk in the direction of lane change
- There is a single dotted lane line in the direction of lane change
- There are no Forward Collision-Avoidance Assist and Blind Spot Collision-Avoidance Assist warnings
- The vehicle is driven in the middle of the lane (should not be driving close to one side of the lane)
- The road you are driving on, or the road you are about to change lane is a road that the function can operate

*** NOTICE**

- When the turn signal lever is placed at A position, the Highway Lane Change Assist function is performed. After that, if the turn signal lever is placed in neutral, Highway Lane Change Assist function is canceled before stepping on the lane.

The Highway Lane Change Assist function is not canceled after stepping on the lane, but when the lane change is completed, it is canceled and the turn signal turns off.

- When the turn signal lever is placed at B position for a certain period of time, the green arrow will appear. At this time, even when the lever is released and returns to its original position, lane change will still be assisted.
- While lane change is being made by the function, the turn signal indicator will blink even when the turn signal lever is not held, and the turn signal indicator will turn off when lane change is complete.

Highway Lane Change Assist standby

Highway Lane Change Assist function will be in the standby state when one of the ready state condition is not satisfied, or when entering or driving on one of the following roads:

- Road within a certain distance from the tollgate on the main road of the highway (or motorway)
- The road ahead ends without an interchange or junction
- Road with sharp curves
- Road with narrow lanes
- Road that is under construction

Highway Lane Change Assist cancel

The function will be canceled when:

- The turn signal lever is turned on in the opposite direction of lane change
- The steering wheel is steered sharply

WARNING

- While the function is operating, the function will cancel if one of the following occurs:
 - Highway Driving Assist is turned off
 - Lane Following Assist or Smart Cruise Control is turned off or temporarily canceled
 - Hands-off warning message is displayed on the cluster
 - The turn signal lever is placed at A position
 - The hazard warning flasher is turned on
 - Forward Collision-Avoidance Assist or Blind-Spot Collision-Avoidance Assist warning message is displayed

- Possible collision is detected in the next lane, even though there are no Forward Collision-Avoidance Assist and Blind Spot Collision-Avoidance Assist warning
- Entering a road under construction
- The target lane to make a lane change disappears
- The target lane to make a lane change is not detected
- There is a problem with turn signal lamps
- Highway Lane Change Assist function is off (The function turns off when the function is turned off from the settings menu, when the road changes to a one-way road, when there is an intersection or crosswalk ahead, when you enter a road with no structure, such as a medium strip, guardrail, etc., or when there is a pedestrian or cyclist on the driving lane.)
- Your vehicle speed is below 75 km/h (45 mph)
- While the function is operating, when the function is canceled, depending on the driving conditions, the vehicle may drive to the middle of the driving lane or steering assist may stop. Always pay attention to road and driving conditions while driving.
- The function may not operate normally on roads with pedestrians or cyclists, such as an intersection or crosswalk. Always pay attention to road and driving conditions while driving.

*** NOTICE**

The images or colors may be displayed differently depending on the specifications of the instrument cluster or theme.

Highway Driving Assist malfunction and limitations

Highway Driving Assist malfunction



A: Check Highway Driving Assist (HDA) system

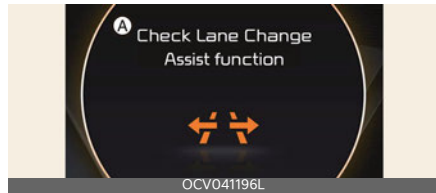

A: Check Lane Change Assist function

When Highway Driving Assist is not working properly, the warning message will appear, and the (⚠️) warning light will illuminate on the cluster. Have Highway Driving Assist be inspected by a professional workshop. Kia recommends visiting an authorized Kia dealer/service partner.

⚠️ WARNING

- The driver is responsible for controlling the vehicle for safe driving.
- Always have your hands on the steering wheel while driving.
- Highway Driving Assist is a supplemental function that assists the driver in driving the vehicle and is not a complete autonomous driving system. Always check road conditions, and if necessary, take appropriate actions to drive safely.

- Always have your eyes on the road, and it is the responsibility of the driver to avoid violating traffic laws. The vehicle manufacturer is not responsible for any traffic violation or accidents caused by the driver.
- Highway Driving Assist may not be able to recognize all traffic situations. The function may not detect possible collisions due to Limitations. Always be aware of the Limitations. Obstacles such as vehicles, motorcycles, bicycles, pedestrians, guardrails, tollgate, unspecified objects, structures, etc. that may collide with the vehicle may not be detected.
- Highway Driving Assist will turn off automatically under the following situations:
 - Driving on roads that the function does not operate, such as a rest area, intersection, junction, etc.
 - The navigation does not operate properly such as when the navigation is being updated or restarted
- Highway Driving Assist may inadvertently operate or turn off depending on road conditions (navigation information) and surroundings.
- Lane Following Assist function may be temporarily disabled when the front view camera cannot detect lanes properly or the hands-off warning is on.
- You may not hear the warning sound of Highway Driving Assist if the surrounding is noisy.
- If the vehicle is driven at high speed above a certain speed at a curve, your vehicle may drive to one side or may depart from the driving lane.
- When you are towing a trailer or another vehicle, we recommend that

Highway Driving Assist is turned off due to safety reasons.

- The hands-off warning message may appear early or late depending on how the steering wheel is held or road conditions. Always have your hands on the steering wheel while driving.
- For your safety, please read the owner's manual before using the Highway Driving Assist.
- Highway Driving Assist will not operate when the vehicle is started, or when the detecting sensors or navigation is being initialized.

Limitations of Highway Driving Assist

Highway Driving Assist and Highway Lane Change function may not operate normally, or may not operate under the following circumstances:

- The map information and the actual road is different because the navigation is not updated
- The map information and the actual road is different because of real-time GPS data or map information error
- The infotainment system is overloaded by simultaneously performing functions such as route search, video playback, voice recognition, etc.
- GPS signals are blocked in areas such as a tunnel
- The driver goes off course or the route to the destination is changed or canceled by resetting the navigation (including TPEG change)
- The vehicle enters a service station or rest area
- Android Auto or Car Play is operating
- The navigation cannot detect the current vehicle position (ex: elevated

roads including overpass adjacent to general roads or nearby roads exist in a parallel way)

- White single dotted lane line or road edge cannot be detected
- The road is temporarily controlled due to construction, etc.
- There is no structure, such as a medium strip, guardrails, etc., on the road
- There is a changeable lane in the direction of lane change

*** NOTICE**

For more details on the limitations of the front view camera and front radar, refer to "Forward Collision-Avoidance Assist (FCA) (if equipped)" on page 6-38.

Rear View Monitor (RVM) (if equipped)



Rear View Monitor will show the area behind the vehicle to assist you when parking or Reversing.

Detecting sensor

Rear view camera



Refer to the picture above for the detailed location of the detecting sensor.

Rear View Monitor settings

Camera settings



With the vehicle on, select the setup icon (⚙️) on the screen or **Settings** → **Vehicle** → **Driver assistance** → **Parking safety**

→ **Camera settings** from the infotainment system screen to change the Rear View Monitor settings.

- Display Contents: To change the settings of rear view with parking guidance.
- Display Settings: To change the screen's brightness and contrast.

Extend Rear Camera Use

With the vehicle on, select or deselect **Settings** → **Vehicle** → **Driver assistance** → **Parking safety** → **Camera settings** → **Display contents** → **Keep rear camera on** from the infotainment system screen to set whether or not to use each function.

Rear View Monitor operation

Parking/View button



Press the Parking/View button (1) to turn on or off Rear View Monitor.

Rear view



Operating conditions

Rear View Monitor will turn on when the following conditions are satisfied:

- Shifting the gear to R (Reverse).
- Pressing the Parking/View button (1) while P (Park) gear position is selected
- Pressing the View icon with the Rear top view on the screen

Off conditions

Rear View Monitor will turn off when the following conditions are satisfied:

- Pressing the Parking/View button (1) again while P (Park) gear position is selected, with the rear view on the screen.
- Changing the gear from R (Reverse) to P (Park).

* NOTICE

The rear view cannot be turned off when the gear is in R (Reverse).

Extended rear view function

Extended rear view function maintains the rear view of the vehicle when shifting the gear from R (Reverse) to N (Neutral) or D (Drive) to help you park safely.

Operating conditions

Rear View Monitor will maintain when the following conditions are satisfied:

- Shifting the gear from R (Reverse) to N (Neutral) or D (Drive).
- The vehicle speed is below approximately 10 km/h (6 mph).

Off conditions

Extended rear view function will turn off when one the following conditions are satisfied:

- The vehicle speed is above approximately 10 km/h (6 mph).
- Pressing the Parking/View button (1).
- Shifting the gear to P (Park).

Rear view while driving



The driver is able to check the rear view on the screen while driving, it is to assist with safe driving.

Operating conditions

Press the Parking/View button (1) while the gear is in D (Drive) or N (Neutral), the driving rear view will appear on the screen.

Off conditions

Rear view while driving function will turn off when one the following conditions are satisfied:

- Pressing the Parking/View button (1) or the infotainment system button (2).
- Shifting the gear to P (Park).

Function operation

If the vehicle is in R (Reverse) during Rear view driving, the screen will change to rear view with parking guidance.

Rear top view

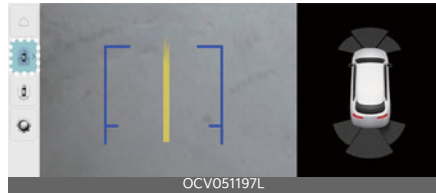

Rear top view shows the distance from the vehicle or the object in the back of your vehicle while parking.

Press the Rear top view button to turn on Rear top view.

Rear View Monitor malfunction and limitations

Rear View Monitor malfunction

When Rear View Monitor is not working properly, or the screen flickers, or the camera image does not display normally, Kia recommends visiting an authorized Kia dealer/service partner.

Limitations of Rear View Monitor

⚠ WARNING

- The rear view camera does not cover the complete area behind the vehicle. The driver should always check the rear area directly through the inside and outside rear view mirror before parking or Reversing.
- The image shown on the screen may differ from the actual distance of the object. Make sure to directly check the vehicle's surroundings for safety.
- Always keep the rear view camera lens clean. If the lens is covered with foreign material, it may adversely affect camera performance and Rear View Monitor may not operate normally. However, do not use chemical solvents such as strong detergents containing high alkaline or volatile organic solvents (gasoline, acetone etc.). This may damage the camera lens.

Surround View Monitor (SVM) (if equipped)



Surround View Monitor can assist in parking by allowing the driver to see around the vehicle.

Detecting sensor



- 1: SVM-front view camera
- 2, 3: SVM-side view camera (under the side view mirror)
- 4: SVM-rear view camera

Refer to the picture above for the detailed location of the detecting sensors.

Surround View Monitor settings

Camera settings



With the vehicle on, select the setup icon (⚙️) on the screen or **Settings** → **Vehicle** → **Driver assistance** → **Parking safety** → **Camera settings** from the infotainment system screen to change the Rear View Monitor settings.

- Display Contents: To change the settings of **Top view parking guidance**, **Parking guide in rear view**, and **Parking distance warning** function.
- Display Settings: To change the screen's brightness and contrast.

Top View Parking Guidance

Front top view



Rear top view



Parking guidance is displayed on the right side of the Surround View Monitor screen when the **Front or Rear Top View Parking Guidance** is selected.

Rear View Parking Guidance

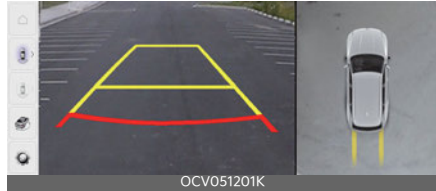

Rear view parking guidance is displayed in the rear view when the **Parking guide in rear view** is selected.

* NOTICE

The horizontal guideline of the Rear View Parking Guidance shows the distance of 0.5 m (1.6 ft.), 1 m (3.3 ft.) and 2.3 m (7.6 ft.) from the vehicle.

Parking Distance Warning



Parking distance warning is displayed on the right side of the Surround View Monitor top view screen when the **Parking distance warning** is selected.

Surround View Monitor Auto On

With the vehicle on, select **Settings** → **Vehicle** → **Driver assistance** → **Parking safety** → **Surround view monitor auto On** from the infotainment system screen to use the function.

* NOTICE

For more details on Surround View Monitor Auto On, refer to "Surround View Monitor Auto On" on page 6-134.

Surround View Monitor operation

Parking/View button



Press the Parking/View button (1) to turn on or off Surround View Monitor.

Front view



Front view function is displayed on the screen when the gear is in N (Neutral) or D (Drive) to assist in parking. The front view has a top view, front view, side view and 3D view. Also, other view modes can be selected by pressing the view icons on the Surround View Monitor screen.

Operating conditions

Front view function will turn on when the following conditions are satisfied:

- Shifting from R (Reverse) to N (Neutral) or D (Drive) and the vehicle speed is below approximately 10 km/h (6 mph).
- Pressing the Parking/View button (1) when the gear is in D (Drive) or N (Neutral) and vehicle speed is below 10 km/h (6 mph).
- Forward Parking Distance Warning warns the driver while driving in D (Drive) (**Settings** → **Vehicle** → **Driver assistance** → **Parking safety** → **Sur-**

round view monitor auto On

selected from the infotainment system screen)

Off conditions

Front view function will turn off when the following conditions are satisfied:

- Press the Parking/View button (1) or the infotainment system button (2).
- When vehicle speed is above 10 km/h (6 mph).
- Press one of the infotainment system button (2), the screen will change to the infotainment system screen.
- Shifting to P (Park).

* NOTICE

If the Surround View Monitor is turned off after driving more than 10 km/h (6 mph), driving below 10 km/h (6 mph) again will not switch to the Surround View Monitor screen.

Rear view

Rear view function is displayed on the screen when the gear is in R (Reverse) or P (Park) to assist in parking. The rear view has a top view, rear view, side view and 3D view. Also, other view modes can be selected by pressing the view icons on the Surround View Monitor screen.

Operating conditions

Rear view function will turn on when the following conditions are satisfied:

- Shifting to R (Reverse).
- Pressing the Parking/View button (1) when P (Park) gear position is selected.

Off conditions

Rear view function will turn off when the following conditions are satisfied:

- Shifting from R (Reverse) to P (Park).
- Pressing the Parking/View button (1) when P (Park) gear position is selected.

* NOTICE

Pressing the infotainment system button (2) will not turn the rear view off when the gear is in R (Reverse).

Rear view while driving

The driver is able to check the rear view on the screen while driving, it is to assist with safe driving.

Operating conditions

Rear view while driving function will turn on when the following conditions are satisfied:

- Pressing the Parking/View button (1) when the vehicle speed is above 10 km/h (6 mph).
- Pressing the view icon on the Surround View Monitor screen when the vehicle speed is below 10 km/h (6 mph).

Off conditions

Rear view while driving function will turn off when the following conditions are satisfied:

- Pressing the Parking/View button (1) or the infotainment system button (2).
- Shifting to P (Park).
- Pressing the other view icon on the Surround View Monitor screen when the vehicle speed is below 10 km/h (6 mph).

Surround View Monitor malfunction and limitations

Surround View Monitor malfunction

When Surround View Monitor is not working properly, or the screen flickers, or the camera image does not display normally, Kia recommends visiting an authorized Kia dealer/service partner.

Limitations of Surround View Monitor

- The screen may be displayed abnormally, and an icon will appear at the top left side of the screen under the following circumstances:
 - The tailgate is opened.
 - The driver or front passenger door is opened.
 - The outside rear view mirror is folded.

⚠ WARNING

- ALWAYS look around your vehicle to make sure there are no objects or obstacles before moving the vehicle. What you see on the screen may differ from the actual vehicle's location.
- The image shown on the screen may differ from the actual distance of the object. Make sure to directly check the vehicle's surroundings for safety.
- Surround View Monitor is designed to be used on a flat surface. Therefore, if used on roads with different heights such as curbs and speed bumps, the image in the screen may not look correct.
- Always keep the camera lens clean. If the lens is covered with foreign material, it may adversely affect camera performance and Surround View Monitor may not operate normally.

However, do not use chemical solvents such as strong detergents containing high alkaline or volatile organic solvents (gasoline, acetone etc.). This may damage the camera lens.

*** NOTICE**

- When Rear View while Driving is on, it stays on while driving regardless of vehicle speed.
- When Rear View while Driving is on while Reversing, the screen changes to the rear view.

Rear Cross-Traffic Collision-Avoidance Assist (RCCA) (if equipped)

Rear Cross-Traffic Collision-Avoidance Assist is designed to help detect vehicles approaching from blind spot area while your vehicle is reversing, and warn the driver that a collision is imminent with a warning message and an audible warning. Also, braking is assisted to help prevent collision.

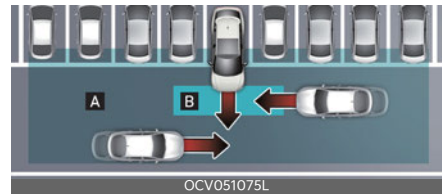

[A]: Rear Cross-Traffic Collision Warning operating range

[B]: Rear Cross-Traffic Collision-Avoidance Assist operating range

⚠ CAUTION

The time of warning may vary depending on vehicle speed of the approaching vehicle.

Detecting sensor

Rear corner radar



Refer to the picture above for the detailed location of the detecting sensor.

*** NOTICE**

For more details on the precautions of the rear corner radar, refer to "Blind-Spot Collision-Avoidance Assist (BCA) (if equipped)" on page 6-62.

Rear Cross-Traffic Collision-Avoidance Assist settings
Setting features

Rear Cross-Traffic Safety

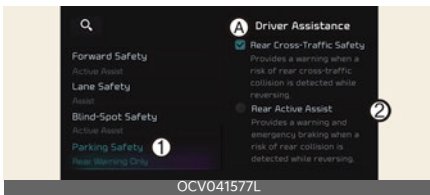

A: Driver assistance

1 Parking safety

2 Rear cross-traffic safety

With the vehicle on, select **Settings** → **Vehicle** → **Driver assistance** → **Parking safety** → **Rear cross-traffic safety** from the infotainment system screen to turn on Rear Cross-Traffic Collision-Avoidance Assist and deselect to turn off the function.

⚠ WARNING

When the vehicle is restarted, Rear Cross-Traffic Collision-Avoidance Assist will automatically turn on. However, if **Off** is selected after the vehicle is restarted, the driver should always be aware of the surroundings and drive safely.

Warning Timing



A: Driver assistance

1 Warning timing

2 Normal

3 Late

With the vehicle on, select **Settings** → **Vehicle** → **Driver assistance** → **Warning timing** from the infotainment system screen to change the initial warning activation time for Rear Cross-Traffic Collision-Avoidance Assist.

When the vehicle is first delivered, Warning Timing is set to **Normal**. If you change the Warning Timing, the warning time of other Driver Assistance systems may change.

Warning Volume



A: Driver assistance

1 Warning volume

2 High

3 Medium

4 Low

5 Off

With the vehicle on, select **Settings** → **Vehicle** → **Driver assistance** → **Warning volume** from the infotainment system screen to change the Warning Volume to **High**, **Medium**, **Low** or **Off**

for Rear Cross-Traffic Collision-Avoidance Assist.

However, when Warning Volume is turned off, the steering wheel vibration function will turn on.

If you change the Warning Volume, the warning volume of other Driver Assistance systems may change.

⚠ CAUTION

- The setting of the Warning Timing and Warning Volume applies to all functions of the Rear Collision-Avoidance Assist.
- Even though **Normal** is selected for Warning Timing, if the vehicles from the blind spot area approaches at high speed, the initial warning activation time may seem late.
- Select **Late** for Warning Timing when traffic is light and when driving speed is slow.

*** NOTICE**

If the vehicle is restarted, Warning Timing and Warning Volume will maintain the last setting.

Rear Cross-Traffic Collision-Avoidance Assist operation

Warning and control

Rear Cross-Traffic Collision-Avoidance Assist will warn and control the vehicle depending on collision level

- Collision Warning
- Emergency Braking
- Stopping vehicle and ending brake control

Collision warning



- To warn the driver of an approaching vehicle from the rear left/right side of your vehicle, the warning light on the outside rear view mirror will blink and a warning will appear on the cluster. At the same time, an audible warning will sound and the steering wheel will vibrate. If the Rear View Monitor is operating, a warning will also appear on the infotainment system screen. (if equipped)
- Rear Cross-Traffic Collision-Avoidance Assist will operate when all the following conditions are satisfied:
 - The gear is shifted to R (Reverse) and the vehicle speed is below 8 km/h (5 mph)
 - The approaching vehicle is within approximately 25 m (82 ft.) from the blind spot area of your vehicle

- The speed of the vehicle approaching from the blind spot area is above 5 km/h (3 mph)

*** NOTICE**

If the operating conditions are satisfied, there will be a warning whenever the vehicle approaches from the left or right side even though your vehicle speed is 0 km/h (0 mph).

Emergency braking



A: Emergency braking

- To warn the driver of an approaching vehicle from the rear left/right side of your vehicle, the warning light on the outside rear view mirror will blink and a warning message will appear on the cluster. At the same time, an audible warning will sound and the steering wheel will vibrate. If the Rear View Monitor is operating, a warning will

also appear on the infotainment system screen. (if equipped)

- Rear Cross-Traffic Collision-Avoidance Assist will operate when all the following conditions are satisfied:
 - The gear is shifted to R (Reverse) and the vehicle speed is below 8 km/h (5 mph)
 - The approaching vehicle is within approximately 1.5 m (5 ft.) from the blind spot area of your vehicle
 - The speed of the vehicle approaching from the left and right is above 5 km/h (3 mph)
- Emergency braking will be assisted to help prevent collision with approaching vehicles from the blind spot area.

⚠ WARNING

Brake control will end:

- The approaching vehicle is out of the detecting range
- The approaching vehicle passes behind your vehicle
- The approaching vehicle does not drive toward your vehicle
- The approaching vehicle speed slows down
- The driver depresses the brake pedal with sufficient power

Stopping vehicle and ending brake control



A: Drive carefully

- When the vehicle is stopped due to emergency braking, the warning message will appear on the cluster. For your safety, the driver should depress the brake pedal immediately and check the surroundings.
 - Brake control will end after the vehicle is stopped by emergency braking for approximately 2 seconds.
 - During emergency braking, braking control by the function will automatically cancel when the driver excessively depresses the brake pedal.

WARNING

Take the following precautions when using Rear Cross-Traffic Collision-Avoidance Assist:

- For your safety, set the Settings after parking the vehicle at a safe location.
- If any other function's warning message is displayed or audible warning is generated, Rear Cross-Traffic Safety function's warning message may not be displayed and audible warning may not be generated.
- You may not hear the warning sound of Rear Cross-Traffic Collision-Avoidance Assist if the surrounding is noisy.
- Rear Cross-Traffic Collision-Avoidance Assist may not operate if the driver applies the brake pedal to avoid collision.
- During Rear Cross-Traffic Safety Function Operation, the vehicle may stop suddenly injuring passengers and shifting loose objects. Always have the seat belt on and keep loose objects secured.
- Even if there is a problem with Rear Cross-Traffic Collision-Avoidance Assist, the vehicle's basic braking performance will operate normally.
- Rear Cross-Traffic Collision-Avoidance Assist does not operate in all situations or cannot avoid all collisions.
- When Rear Cross-Traffic Collision-Avoidance Assist is operating, braking control by the function will automatically cancel when the driver excessively depresses the accelerator pedal.
- Rear Cross-Traffic Collision-Avoidance Assist may warn the driver late or may not warn the driver depending on the road and driving conditions.
- The driver should hold the responsibility to control the vehicle. Do not solely depend on Rear Cross-Traffic Collision-Avoidance Assist. Rather, maintain a safe braking distance, and if necessary, depress the brake pedal to reduce driving speed or to stop the vehicle.
- Never deliberately operate Rear Cross-Traffic Collision-Avoidance Assist on people, animal, objects, etc. It may cause serious injury or death.

CAUTION

The brake control may not operate properly depending on the status of ESC (Electronic Stability Control).

There will only be a warning when:

- The ESC (Electronic Stability Control) warning light is on
- ESC (Electronic Stability Control) is engaged in a different function

*** NOTICE**

If braking is assisted by Rear Cross-Traffic Collision-Avoidance Assist, the driver must immediately depress the brake pedal and check vehicle surroundings.

- Brake control will end when the driver depresses the brake pedal with sufficient power.
- After shifting the gear to R (Reverse), braking control will operate once for left and right vehicle approach.

*** NOTICE**

The images or colors may be displayed differently depending on the specifications of the instrument cluster or theme.

Rear Cross-Traffic Collision-Avoidance Assist malfunction and limitations

Rear Cross-Traffic Collision-Avoidance Assist malfunction

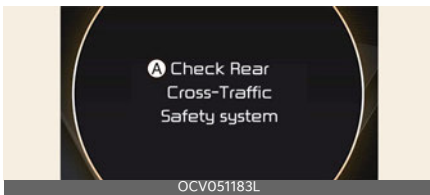

A: Check Rear Cross-Traffic Safety system

When Rear Cross-Traffic Collision-Avoidance Assist is not working properly, the warning message will appear and the master warning light (⚠️) will illuminate on the cluster. Have the function be inspected by a professional workshop. Kia recommends visiting an authorized Kia dealer/service partner.



A: Check side view mirror warning light

When the outside rear view mirror warning light is not working properly, the warning message will appear and the master warning light (⚠️) will illuminate on the cluster. Have the function be inspected by a professional workshop. Kia recommends visiting an authorized Kia dealer/service partner.

Rear Cross-Traffic Collision-Avoidance Assist disabled

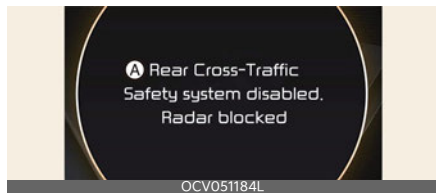

A: Rear Cross-Traffic Safety system disabled. Radar blocked

When the rear bumper around the rear corner radar or rear sensor is covered with foreign material, such as snow or rain, or installing a trailer or carrier, it can reduce the detecting performance and temporarily limit or disable Rear Cross-Traffic Collision-Avoidance Assist.

If this occurs, the warning message will appear on the cluster. But it is not a Rear Cross-Traffic Collision-Avoidance Assist malfunction.

The function will operate normally when such foreign material or trailer, etc. is removed. Always keep it clean.

If the function does not operate normally after it is removed, have the function be inspected by a professional workshop. Kia recommends visiting an authorized Kia dealer/service partner.

⚠ WARNING

- Even though the warning message or warning light does not appear on the cluster, Rear Cross-Traffic Collision-Avoidance Assist may not operate properly.
- Rear Cross-Traffic Collision-Avoidance Assist may not operate properly in an area or contaminated (for example: open terrain), where any substance are not detected after turning ON the vehicle.

⚠ CAUTION

Turn off Rear Cross-Traffic Collision-Avoidance Assist to install a trailer, carrier, etc., or remove the trailer, carrier, etc. to use Rear Cross-Traffic Collision-Avoidance Assist.

Limitations of Rear Cross-Traffic Collision-Avoidance Assist

Rear Cross-Traffic Collision-Avoidance Assist may not operate normally, or the function may operate unexpectedly under the following circumstances:

- Departing from where trees or grass are overgrown
- Departing from where roads are wet
- Speed of the approaching vehicle is fast or slow

Braking control may not work, driver's attention is required in the following circumstances:

- The vehicle severely vibrates while driving over a bumpy road, uneven road or concrete patch
- Driving on a slippery surface due to snow, water puddle, ice, etc.
- The tire pressure is low or a tire is damaged
- The brake is reworked
- Remote Smart Parking Assist is operating (if equipped)

*** NOTICE**

For more details on the limitations of the rear corner radar, refer to "Blind-Spot Collision-Avoidance Assist (BCA) (if equipped)" on page 6-62.

⚠ WARNING

- Driving near a vehicle or structure



[A]: Structure

Rear Cross-Traffic Collision-Avoidance Assist may be limited when driving near a vehicle or structure, and may not detect the vehicle approaching from the blind spot area. If this occurs, the function may not warn the driver or control the brakes when necessary.

Always check your surroundings while Reversing.

Driving your vehicle

- When the vehicle is in a complex parking environment

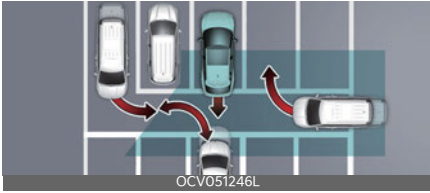

Rear Cross-Traffic Collision-Avoidance Assist may detect vehicles which are parking or pulling out near your vehicle (for example: a vehicle leaving beside your vehicle, a vehicle parking or pulling out in the rear area, a vehicle approaching your vehicle making a turn, etc.). If this occurs, the function may unnecessarily warn the driver and control the brake.

Always check your surroundings while Reversing.

- When the vehicle is parked diagonally



[A]: Vehicle

Rear Cross-Traffic Collision-Avoidance Assist may be limited when Reversing diagonally, and may not detect the vehicle approaching from the blind spot area. If this occurs, the function may not warn the driver or control the brakes when necessary.

Always check your surroundings while Reversing.

Rear Cross-Traffic Collision-Avoidance Assist (RCCA)

- When the vehicle is on or near a slope



Rear Cross-Traffic Collision-Avoidance Assist may be limited when the vehicle is on a uphill or downhill slope, or near it, and may not detect the vehicle approaching from the blind spot area. If this occurs, the function may not warn the driver or control the brakes when necessary.

Always check your surroundings while Reversing.

- Pulling into the parking space where there is a structure



[A]: Structure, [B]: Wall

Rear Cross-Traffic Collision-Avoidance Assist may detect vehicles passing by in front of you when parking backwards into a parking space with a wall or structure in the rear or side area. If this occurs, the function may unnecessarily warn the driver and control the brake.

Always check your surroundings while Reversing.

- When the vehicle is parked rearward



Rear Cross-Traffic Collision-Avoidance Assist may detect vehicles passing by behind you when parking backwards into a parking space. If this occurs, the function may unnecessarily warn the driver and control the brake.

Always check your surroundings while Reversing.

WARNING

- When you are towing a trailer or another vehicle, do not use Rear Cross-Traffic Collision-Avoidance Assist. The function could destabilize the vehicle.
- Rear Cross-Traffic Collision-Avoidance Assist may not operate suddenly if interfered by strong electromagnetic waves.
- Rear Cross-Traffic Collision-Avoidance Assist may not operate for 15 seconds after the vehicle is started, or the rear corner radars are initialized.

Reverse Parking Distance Warning (PDW) (if equipped)

Reverse Parking Distance Warning will help warn the driver if a person, an animal or an object is detected within a certain distance when the vehicle is moving in reverse.

Detecting sensor

Rear ultrasonic sensors



Refer to the picture above for the detailed location of the detecting sensors.

Reverse Parking Distance Warning settings

Warning Volume



A: Driver assistance

1 Warning volume

2 High

3 Medium

4 Low

5 Off

Select **Settings** → **Vehicle** → **Driver assistance** → **Warning volume** from infotainment system screen to change the Warning Volume to **High**, **Medium**,

Low or **Off** for Reverse Parking Distance Warning.

*** NOTICE**

- If you change the Warning Volume, the warning volume of other Driver Assistance systems may change.
- Even if **Off** is selected, the Warning Volume of Reverse Parking Distance Warning will not turn off but the volume will sound as **Low**.

Parking Distance Warning Auto On

You can set the Parking Distance Warning to be ON at low speeds. To use Parking Distance Warning Auto On function, select **Settings** → **Vehicle** → 'Driver Assistance' → **Parking safety** → **Parking Distance Warning Auto On** from the infotainment system with the vehicle ON.

*** NOTICE**

If Parking Distance Warning Auto On is selected, the Parking Safety (P+▲) button indicator light will turn on.

Reverse Parking Distance Warning operation

Parking Safety button (if equipped)



Press the Parking Safety (P+▲) button to turn on or off Reverse Parking Distance Warning.

- When Reverse Parking Distance Warning is off (button indicator light off), if you shift the gear to R (Reverse), Reverse Parking Distance Warning will automatically turn on.
- If you shift the gear to R (Reverse), Reverse Parking Distance Warning will not turn off even if you press the Parking Safety (P+▲) button for your safety.

Reverse Parking Distance Warning

Reverse Parking Distance Warning will operate under the following conditions.

- Shift the gear to R (Reverse).
- The vehicle's speed is below 10 km/h (6 mph).

Function indications and warnings

Distance from object	Warning indicator when driving backward	Warning sound
60~120 cm (24~48 inches)		Buzzer beeps intermittently
30~60 cm (12~24 inches)		Beeps more frequently
within 30 cm (12 inches)		Beeps continuously

- The corresponding indicator will illuminate on the cluster or infotainment system whenever each ultrasonic sensor detects a person, animal or object in its sensing range. Also an audible warning will sound.
- When more than two objects are detected at the same time, the closest

one will be warned with an audible warning.

- Distance from object may be detected differently when obstacles are not located in front of the sensor.
- The shape of the indicator in the illustration may differ from the actual vehicle.

Reverse Parking Distance Warning malfunction and precautions

Reverse Parking Distance Warning malfunction

After starting the vehicle, a beep will sound once when the gear is shifted to R (Reverse) to indicate Reverse Parking Distance Warning is operating normally. However, if one or more of the following occurs, first check whether the ultrasonic sensor is damaged or blocked with foreign material. If it still does not work properly, Kia recommends visiting an authorized Kia dealer/service partner.

- The audible warning does not sound.
- The buzzer sounds intermittently.
- The warning message appears on the cluster.

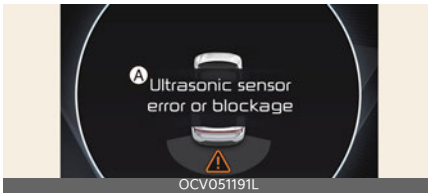

A: Ultrasonic sensor error or blockage

Limitations of Reverse Parking Distance Warning

- Reverse Parking Distance Warning may not operate normally when:
 - Moisture is frozen to the sensor (Reverse Parking Distance Warn-

ing will operate normally when it is melted.)

- Sensor is covered with foreign material, such as snow or water (Reverse Parking Distance Warning will operate normally when such foreign material are removed.)
- The weather is extremely hot or cold
- The sensor or sensor assembly is disassembled
- The surface of the sensor is pressed hard or an impact is applied with a hard object
- The surface of the sensor is scratched with a sharp object
- The sensors or its surrounding area is directly sprayed with high pressure washer
- Reverse Parking Distance Warning may malfunction when:
 - Heavy rain or water spray is present
 - Water flows on the surface of the sensor
 - Affected by another vehicle's sensors
 - The sensor is covered with snow
 - Driving on uneven road, gravel roads or bushes
 - Objects that generates ultrasonic waves are near the sensor
 - Installing the license plate differently from the original location
 - The vehicle bumper height or ultrasonic sensor installation has been modified
 - Attaching equipments or accessories around the ultrasonic sensors
- The following objects may not be detected:

- Sharp or slim objects, such as ropes, chains or small poles.
- Objects, which tend to absorb sensor frequency, such as clothes, spongy material or snow.
- Objects smaller than 100 cm (40 inches) in length and narrower than 14 cm (6 inches) in diameter.
- Pedestrians, animals or objects that are very close to the ultrasonic sensors

⚠ WARNING

- Reverse Parking Distance Warning is a supplemental function. The operation of Reverse Parking Distance Warning can be affected by several factors (including environmental conditions). It is the responsibility of the driver to always check the rear view before and while parking.
- Your vehicle warranty does not cover any accidents or damage to the vehicle due to the malfunction of Reverse Parking Distance Warning.
- Pay close attention when driving near objects, pedestrians, and especially children. Some objects may not be detected by the ultrasonic sensors, due to the objects distance, size or material, all of which can limit the effectiveness of the sensor.
- Parking Distance Warning indicator may not occur sequentially depending on vehicle speed or obstacle shape.
- If Forward/Reverse Parking Distance Warning needs repair, Kia recommends visiting an authorized Kia dealer/service partner.

Forward/Reverse Parking Distance Warning (PDW) (if equipped)

Forward/Reverse Parking Distance Warning will help warn the driver if a person, an animal or an object is detected within a certain distance from the ultrasonic sensors when the vehicle is moving forward or in reverse.

Detecting sensor

Front ultrasonic sensors



Rear ultrasonic sensors



Refer to the picture above for the detailed location of the detecting sensors.

Forward/Reverse Parking Distance Warning settings

Warning Volume

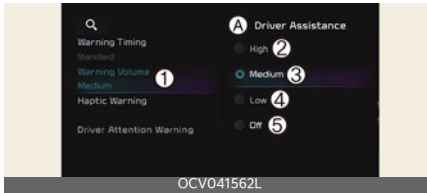

A: **Driver assistance**

1 Warning volume

2 High

3 Medium

4 Low

5 Off

Select **Settings** → **Vehicle** → **Driver assistance** → **Warning volume** from the infotainment system screen to change the Warning Volume to **High**, **Medium**, **Low** or **Off** for Forward/Reverse Parking Distance Warning.

* NOTICE

- If you change the Warning Volume, the warning volume of other Driver Assistance systems may change.
- Even if **Off** is selected, the Warning Volume of Forward/Reverse Parking Distance Warning will not turn off but the volume will sound as **Low**.

Parking Distance Warning Auto On

You can set the parking distance warning to be ON at low speeds. To use Parking Distance Warning Auto On function, select **Settings** → **Vehicle** → **Driver assistance** → **Parking safety** → **Parking Distance Warning Auto On** from the infotainment system screen.

* NOTICE

If Parking Distance Warning Auto On is selected, the Parking Safety (P_A) button indicator light will turn on.

Forward/Reverse Parking Distance Warning operation

Parking Safety button



Press the Parking Safety (P_A) button to turn on or off Forward/Reverse Parking Distance Warning.

- When Forward/Reverse Parking Distance Warning is off (button indicator light off), if you shift the gear to R (Reverse), Forward/Reverse Parking Distance Warning will automatically turn on.
- If you shift the gear to R (Reverse), Forward/Reverse Parking Distance Warning will not turn off even if you press the Parking Safety (P_A) button for your safety.

Forward Parking Distance Warning



Forward Parking Distance Warning will operate when one of the condition is satisfied.

- The gear is shifted from R (Reverse) to D (Drive)
- The gear is in D (Drive) and the Parking Safety (P+L) button indicator light is on
- **Parking Distance Warning Auto On** is selected from the Settings menu and the gear is in D (Drive)
- The function warns the driver when **Settings** → **Vehicle** → 'Driver Assistance' → **Parking safety** → **Parking Distance Warning Auto On** is selected from the infotainment system, and the gear is in D (Drive)
- Vehicle speed is below 10 km/h (6 mph)

* NOTICE

- Forward Parking Distance Warning does not operate when the vehicle's forward speed is above 10 km/h (6 mph) even when the function is on (Parking Safety button indicator is on). Forward Parking Distance Warning will operate again when the vehicle's forward speed decreases below 10 km/h (6 mph).
- When the vehicle's forward speed is above 30 km/h (18 mph), the Forward Parking Distance Warning will turn off (Parking Safety button indicator off). Although you drive below 10 km/h (6 mph) again, Forward Parking Distance Warning will not automatically turn on.

Function indications and warnings

Distance from object	Warning indicator when driving forward	Warning sound
60-100 cm (24-40 inches)		Buzzer beeps intermittently
30-60 cm (12-24 inches)		Beeps more frequently
within 30 cm (12 inches)		Beeps continuously

- The corresponding indicator will illuminate on the cluster or infotainment system screen whenever each ultrasonic sensor detects a person, animal or object in its sensing range. Also an audible warning will sound.
- When more than two objects are detected at the same time, the closest one will be warned with an audible warning.
- Distance from object may be detected differently when obstacles are not located in front of the sensor.
- The shape of the indicator in the illustration may differ from the actual vehicle.

Reverse Parking Distance Warning



Reverse Parking Distance Warning will operate when one of the condition is satisfied.

- The gear is shifted to R (Reverse).
- The vehicle's rearward speed is below 10 km/h (6 mph).

*** NOTICE**

When the vehicle's rearward speed is below 10 km/h (6 mph), both the front and rear ultrasonic sensors will detect objects. However, the front ultrasonic sensors can detect a person, animal or object when it is within 60 cm (24 inches) from the sensors.

Function indications and warnings

Distance from object	Warning indicator when driving backward	Warning sound
60~120 cm (24~48 inches)		Buzzer beeps intermittently
30~60 cm (12~24 inches)		Beeps more frequently
within 30 cm (12 inches)		Beeps continuously

- The corresponding indicator will illuminate on the cluster or infotainment system screen whenever each ultrasonic sensor detects a person, animal or object in its sensing range. Also an audible warning will sound.
- When more than two objects are detected at the same time, the closest one will be warned with an audible warning.
- Distance from object may be detected differently when obstacles are not located in front of the sensor.
- The shape of the indicator in the illustration may differ from the actual vehicle.

Forward/Reverse Parking Distance Warning malfunction and precautions

Forward/Reverse Parking Distance Warning malfunction

After starting the vehicle, a beep will sound once when the gear is shifted to R (Reverse) to indicate Forward/Reverse Parking Distance Warning is operating normally.

However, if one or more of the following occurs, first check whether the ultrasonic sensor is damaged or blocked with foreign material. If it still does not work properly, Kia recommends visiting an authorized Kia dealer/service partner.

- The audible warning does not sound.
- The buzzer sounds intermittently.
- The warning message appears on the cluster.

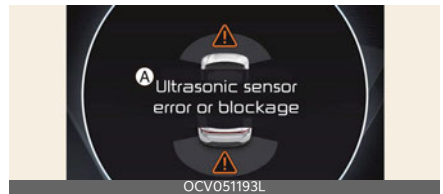

A: Ultrasonic sensor error or blockage

Limitations of Forward/Reverse Parking Distance Warning

- Forward/Reverse Parking Distance Warning may not operate normally when:
 - Moisture is frozen to the sensor (Forward/Reverse Parking Distance Warning will operate normally when it is melted.)
 - Sensor is covered with foreign material, such as snow or water (Forward/Reverse Parking Distance Warning will operate nor-

- mally when such foreign material are removed.)
- The weather is extremely hot or cold
- The sensor or sensor assembly is disassembled
- The surface of the sensor is pressed hard or an impact is applied with a hard object
- The surface of the sensor is scratched with a sharp object
- The sensors or its surrounding area is directly sprayed with high pressure washer
- Forward/Reverse Parking Distance Warning may malfunction when:
 - Heavy rain or water spray is present
 - Water flows on the surface of the sensor
 - Affected by another vehicle's sensors
 - The sensor is covered with snow
 - Driving on uneven road, gravel roads or bushes
 - Objects that generates ultrasonic waves are near the sensor
 - Installing the license plate differently from the original location
 - The vehicle bumper height or ultrasonic sensor installation has been modified
 - Attaching equipments or accessories around the ultrasonic sensors
- The following objects may not be detected:
 - Sharp or slim objects, such as ropes, chains or small poles.
 - Objects, which tend to absorb sensor frequency, such as clothes, spongy material or snow.

- Objects smaller than 100 cm (40 inches) in length and narrower than 14 cm (6 inches) in diameter.
- Pedestrians, animals or objects that are very close to the ultrasonic sensors

⚠ WARNING

- Forward/Reverse Parking Distance Warning is a supplemental function. The operation of Forward/Reverse Parking Distance Warning can be affected by several factors (including environmental conditions). It is the responsibility of the driver to always check the front and rear views before and while parking.
 - Your vehicle warranty does not cover any accidents or damage to the vehicle due to the malfunction of Forward/Reverse Parking Distance Warning.
 - Pay close attention when driving near objects, pedestrians, and especially children. Some objects may not be detected by the ultrasonic sensors, due to the objects distance, size or material, all of which can limit the effectiveness of the sensor.
 - Parking Distance Warning indicator may not occur sequentially depending on vehicle speed or obstacle shape.
 - If Forward/Reverse Parking Distance Warning needs repair, Kia recommends visiting an authorized Kia dealer/service partner.
-

Reverse Parking Collision-Avoidance Assist (PCA) (if equipped)

Reverse Parking Collision-Avoidance Assist will can warn the driver or assist with braking to help reduce the possibility of collision with a pedestrian or an object when Reversing.

Detecting sensor

Rear view camera



Rear ultrasonic sensors



Refer to the picture above for the detailed location of the detecting sensors.

Reverse Parking Collision- Avoidance Assist settings

Parking Safety

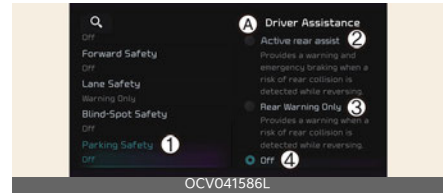

A: Driver assistance

- 1 Parking safety
- 2 Rear Active Assist
- 3 Rear warning only
- 4 Off

With the vehicle on, select or deselect **Settings** → **Vehicle** → **Driver assistance** → **Parking safety** from the infotainment system screen to set whether or not to use each function.

- **Rear Active Assist:** Reverse Parking Collision-Avoidance Assist will warn the driver and assist with braking when a collision with a pedestrian or an object is imminent.
- **Rear Warning Only:** Reverse Parking Collision-Avoidance Assist will warn the driver when a collision with a pedestrian or an object is imminent. Braking will not be assisted.
- **Off:** Reverse Parking Collision-Avoidance Assist will turn off.

Turning On/Off



OCV041048L

Press and hold the Parking Safety (P+L) button for more than 2 seconds to turn Active Rear assist or Rear Warning Only on or off.

Warning Timing

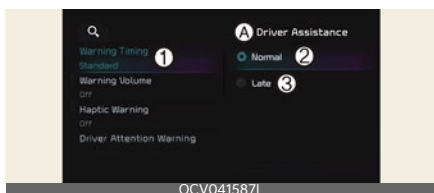

OCV041587L

A: **Driver assistance**

- 1 **Warning timing**
- 2 **Normal**
- 3 **Late**

With the vehicle on, select **Settings** → **Vehicle** → **Driver assistance** → **Warning timing** from the infotainment system screen to change the initial warning activation time for Reverse Parking Collision-Avoidance Assist.

- **Normal:** Use in a normal driving environment. If the function operates too sensitively, set to the warning timing to **Late**.
- **Late:** The warning timing will be slow.

* NOTICE

If you change the Warning Timing, the Warning Timing of other Driver Assistance systems may change.

Warning Volume

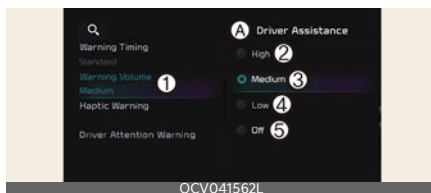

OCV041562L

A: **Driver assistance**

- 1 **Warning volume**
- 2 **High**
- 3 **Medium**
- 4 **Low**
- 5 **Off**

With the vehicle on, select **Settings** → **Vehicle** → **Driver assistance** → **Warning volume** from the infotainment system screen to change the Warning Volume to **High**, **Medium**, **Low** or **Off** for Reverse Parking Collision-Avoidance Assist.

* NOTICE

- If you change the Warning Volume, the warning volume of other Driver Assistance systems may change.
- However, even if **Off** is selected, the volume will not turn off but the volume will sound as **Low**.

Reverse Parking Collision- Avoidance Assist operation

Operating conditions

After selecting **Active assistance** or **Warning only** from the Settings menu, Reverse Parking Collision-Avoidance Assist will turn on when the following conditions are satisfied:

- The tailgate is closed
- The gear is shifted to R (Reverse)

Driving your vehicle

- Vehicle speed is below 10 km/h (6 mph)
- Reverse Parking Collision-Avoidance Assist components such as the rear view camera and the rear ultrasonic sensors are in normal conditions

When Reverse Parking Collision-Avoidance Assist activates, a line appears behind the vehicle image in the instrument cluster.

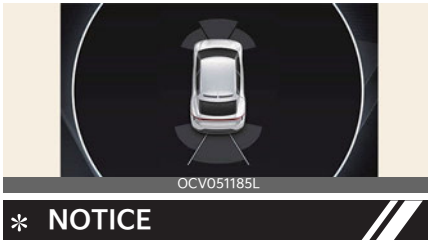

* NOTICE

Reverse Parking Collision-Avoidance Assist operates only once after the gear is shifted to R (Reverse). To reactivate Reverse Parking Collision-Avoidance Assist, shift the gear from another gear to R (Reverse).

Active rear assist

If Reverse Parking Collision-Avoidance Assist detects a risk of collision with a pedestrian or an object, Reverse Parking Collision-Avoidance Assist will warn the driver with an audible warning and warning message on the cluster. When Rear View Monitor is operating, a warning will appear on the infotainment system screen. The warning will turn off when the driver shifts the gear to P (Park), N (Neutral), or D (Drive).

If Reverse Parking Collision-Avoidance Assist detects an imminent collision with a pedestrian or an object behind the vehicle, Reverse Parking Collision-Avoidance Assist will assist you with braking. The driver needs to pay atten-

Reverse Parking Collision-Avoidance Assist (PCA)

tion as the brake assist will end within 5 minutes. Brake control will also end when:

- The gear is shifted to P (Park) or D (Drive).
- The driver depresses the brake pedal with sufficient power.

* NOTICE

If braking assist has lasted for approximately 5 minutes, the Electronic Parking Brake **EPB** will be engaged simultaneously.

Rear Warning Only

If Reverse Parking Collision-Avoidance Assist detects a risk of collision with a pedestrian or an object, Reverse Parking Collision-Avoidance Assist will warn the driver with an audible warning and warning message on the cluster. When Rear View Monitor is operating, a warning will appear on the infotainment system screen. Braking will not be assisted. The warning will turn off when the gear is shifted to P (Park), N (Neutral) or D (Drive).

Reverse Parking Collision-Avoidance Assist malfunction and limitations

Reverse Parking Collision-Avoidance Assist malfunction

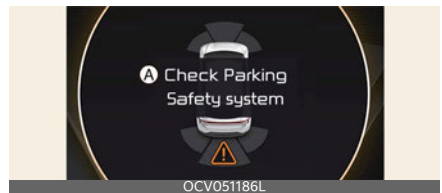

A: Check Parking Safety system

When Reverse Parking Collision-Avoidance Assist or other related functions

are not working properly, the warning message will appear on the cluster, and Reverse Parking Collision-Avoidance Assist will turn off automatically.

Kia recommends visiting an authorized Kia dealer/service partner.

Reverse Parking Collision-Avoidance Assist disabled

Rear view camera



The rear view camera is used as a detecting sensor to detect pedestrians. If the camera lens is covered with foreign material, such as snow or rain, it may adversely affect camera performance and Reverse Parking Collision-Avoidance Assist may not operate normally. Always keep the camera lens clean.

Rear ultrasonic sensors



The rear ultrasonic sensors are located inside the rear bumper to detect objects in the rear area. If the sensors are covered with foreign material, such as snow or rain, it may adversely affect sensor performance and Reverse Parking Collision-Avoidance Assist may not operate normally. Always keep the rear bumper clean.

The warning message will appear on the cluster if the following situations occur:

Rear view camera

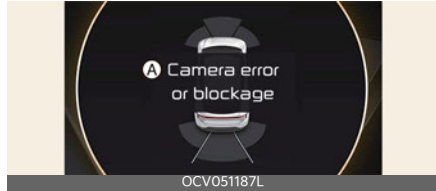

A: Camera error or blockage

Rear ultrasonic sensors



A: Ultrasonic sensor error or blockage

- The rear view camera or rear ultrasonic sensor(s) is covered with foreign material, such as snow or rain, etc.
- There is inclement weather, such as heavy snow, heavy rain, etc.

If this occurs, Reverse Parking Collision-Avoidance Assist may turn off or may not operate properly. Check whether the rear view camera and rear ultrasonic sensors are clean.

Limitations of Reverse Parking Collision-Avoidance Assist

Reverse Parking Collision-Avoidance Assist may not assist braking or warn the driver even if there are pedestrians or objects under the following circumstances:

- Any non-factory equipment or accessory is installed
- Your vehicle is unstable due to an accident or other causes

- Bumper height or rear ultrasonic sensor installation has been modified
- Rear view camera or rear ultrasonic sensor(s) is damaged
- Rear view camera or the rear ultrasonic sensor(s) is stained with foreign material, such as snow, dirt, etc.
- Rear view camera is obscured by a light source or by inclement weather, such as heavy rain, fog, snow, etc.
- The surrounding is very bright or very dark
- Outside temperature is very high or very low
- The wind is either strong (above 20 km/h (12 mph)) or blowing perpendicular to the rear bumper
- Objects generating excessive noise, such as vehicle horns, loud motorcycle engines or truck air brakes, are near your vehicle
- An ultrasonic sensor with similar frequency is near your vehicle
- The pedestrians are difficult to recognize under following conditions:
 - There is ground height difference between the vehicle and the pedestrian
 - The image of the pedestrian in the rear view camera is indistinguishable from the background
 - The pedestrian is near the rear edge of the vehicle
 - The pedestrian is not standing upright
 - The pedestrian is either very short or very tall for Reverse Parking Collision-Avoidance Assist to detect
 - The pedestrian or cyclist is wearing clothing that easily blends into the background, making it difficult to detect

- The pedestrian is wearing clothing that does not reflect ultrasonic waves well
- Size, thickness, height, or shape of the object does not reflect ultrasonic waves well (e.g., pole, bush, curbs, carts, edge of a wall, etc.)
- The pedestrian or the object is moving
- The pedestrian or the object is very close to the rear of the vehicle
- A wall is behind the pedestrian or the object
- The object is not located at the rear center of your vehicle
- The object is not parallel to the rear bumper
- The road is slippery or inclined
- The driver backs up the vehicle immediately after shifting to R (Reverse)
- The driver accelerates or circles the vehicle

Reverse Parking Collision-Avoidance Assist may unnecessarily warn the driver or assist with braking even if there are no pedestrians or objects under the following circumstances:

- Any non-factory equipment or accessory is installed
- Your vehicle is unstable due to an accident or other causes
- Bumper height or rear ultrasonic sensor installation has been modified
- Your vehicle height is low or high due to heavy loads, abnormal tire pressure, etc.
- Rear view camera or the rear ultrasonic sensor(s) is stained with foreign material, such as snow, dirt, etc.
- The pattern on the road is mistaken for a pedestrian

Driving your vehicle

- There is shadow or light reflecting on the ground
- Pedestrians or objects are around the path of the vehicle
- Objects generating excessive noise, such as vehicle horns, loud motorcycle engines or truck air brakes, are near your vehicle
- Your vehicle is backing towards a narrow passage or parking space
- Your vehicle is backing towards an uneven road surface, such as an unpaved road, gravel, bump, gradient, etc.
- A trailer or carrier is installed on the rear of your vehicle
- An ultrasonic sensor with similar frequency is near your vehicle

WARNING

- Always pay extreme caution while driving. The driver is responsible for controlling the brake for safe driving.
- Always pay attention to road and traffic conditions while driving, whether or not there is a warning.
- Always look around your vehicle to make sure there are no pedestrians or objects before moving the vehicle.
- The performance of Reverse Parking Collision-Avoidance Assist may vary under certain conditions. If vehicle speed is above 4 km/h (2 mph), Reverse Parking Collision-Avoidance Assist will provide collision avoidance assist only when pedestrians are detected. Always look around and pay attention when Reversing your vehicle.
- Some objects may not be detected by the rear ultrasonic sensors due to the objects distance, size or material, all of

Reverse Parking Collision-Avoidance Assist (PCA)

- which can limit the effectiveness of the sensor.
- Reverse Parking Collision-Avoidance Assist may not operate properly or may operate unnecessarily depending on the road conditions and the surroundings.
- Do not solely rely on Reverse Parking Collision-Avoidance Assist. Doing so may lead to vehicle damage or injuries.
- Always keep the rear view camera and rear ultrasonic sensors clean.
- Do not use any cleanser containing acid or alkaline detergents when cleaning the rear view camera lens. Use only a mild soap or neutral detergent, and rinse thoroughly with water.
- Do not spray the rear view camera or the rear ultrasonic sensors or their surrounding area directly with a high pressure washer. It may cause the rear view camera or the rear ultrasonic sensors to malfunction.
- Do not apply objects, such as a bumper sticker or a bumper guard, near the rear view camera or rear ultrasonic sensors or apply paint to the bumper. Doing so may adversely affect the performance of Reverse Parking Collision-Avoidance Assist.
- Never disassemble or apply impact on the rear view camera or the rear ultrasonic sensors components.
- Do not apply unnecessary force on the rear view camera or the rear ultrasonic sensors. Reverse Parking Collision-Avoidance Assist may not operate properly if the rear view camera or the rear ultrasonic sensor(s) is forcibly moved out of proper alignment. Kia recommends visiting an authorized Kia dealer/service partner.

- Noise may be heard when sudden braking occurs to avoid a collision.
- If any other warning sound such as the seat belt warning chime is already generated, Reverse Parking Collision-Avoidance Assist warning may not sound.
- Reverse Parking Collision-Avoidance Assist may not work properly if the bumper has been damaged, replaced or repaired.
- Reverse Parking Collision-Avoidance Assist may not operate normally if interfered by strong electromagnetic waves.
- Playing the vehicle audio system at high volume may prevent passengers from hearing Reverse Parking Collision-Avoidance Assist warning sounds.
- The brake control may not operate properly depending on the status of ESC (Electronic Stability Control).
There will only be a warning when:
 - The ESC (Electronic Stability Control) warning light is on
 - ESC (Electronic Stability Control) is engaged in a different function





*** NOTICE**

Reverse Parking Collision-Avoidance Assist can detect a pedestrian or an object when:

- A pedestrian is standing behind the vehicle
- A large obstacle, such as a vehicle, is parked in the rear center of your vehicle

Remote Smart Parking Assist (RSPA) (if equipped)

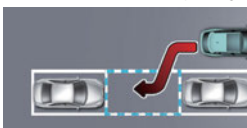
Remote Smart Parking Assist uses vehicle sensors to help the driver park and exit parking spaces remotely from outside the vehicle by automatically searching for parking spaces, and controlling the steering wheel, vehicle speed and gearshifts.

Function	Description
Remote Operation	Remotely moving forward or backward  OCV051082L
Smart Parking or Remote Smart Parking	Perpendicular reverse parking  OCV051083L
	Parallel reverse parking  OCV051084L
Smart Exit	Parallel forward exit  OCV051085L

- Remote Smart Parking and Remote Operation function may be operated from outside the vehicle using the smart key.
- Smart Parking and Remote Smart Parking function may be operated from inside the vehicle.

- Smart Parking and Remote Smart Parking function helps the driver with perpendicular reverse parking and parallel reverse parking.
- Smart Exit function helps the driver with parallel forward exit.
- When Remote Smart Parking Assist operates, Parking Distance Warning and Surround View Monitor will also operate. For more details, refer to "Forward/Reverse Parking Distance Warning (PDW) (if equipped)" on page 6-148 and "Surround View Monitor (SVM) (if equipped)" on page 6-133.

Detecting sensor

Front ultrasonic sensors



Front side ultrasonic sensors



Rear side ultrasonic sensors



Rear ultrasonic sensors



Refer to the picture above for the detailed location of the detecting sensors.

WARNING

- Never disassemble the detecting sensor or sensor assembly, or apply any impact on it.
- If the detecting sensor have been replaced or repaired, we recommend that you have your vehicle inspected by an authorized Kia dealer/service partner.
- Remote Smart Parking Assist may malfunction if the vehicle bumper height or ultrasonic sensor installation has been modified or damaged. Any non-factory installed equipment or accessories may also interfere with the sensor performance.
- When the ultrasonic sensor is frozen or stained with snow, dirt, or water, the sensor may not operate until the stains are removed using a soft cloth.
- Do not push, scratch or strike the ultrasonic sensor. Sensor damage could occur.
- Do not spray the ultrasonic sensors or its surrounding area directly with a high pressure washer.

Remote Smart Parking Assist settings

Setting features

Warning Volume

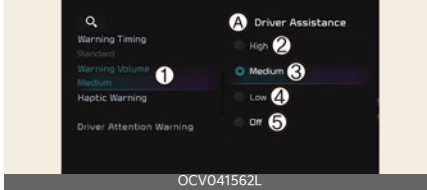

A: Driver assistance

1 Warning volume

2 High

3 Medium

4 Low

5 Off

With the vehicle on, select **Settings** → **Vehicle** → **Driver assistance** → **Warning volume** from the infotainment system screen to change the Warning Volume to **High**, **Medium**, **Low** or **Off** for Remote Smart Parking Assist.





* NOTICE

- If you change the warning volume, the Warning Volume of other Driver Assistance systems may change.
- However, even if **Off** is selected, the function's Warning Volume will not turn off but the volume will sound as **Low**.

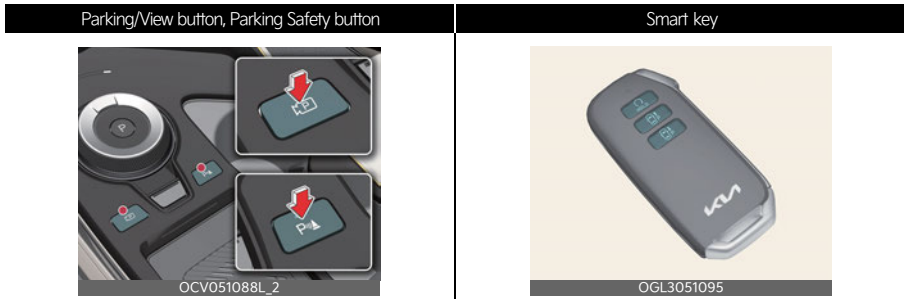
Remote Smart Parking Assist operation

Remote Smart Parking button



Location	Name	Symbol	Description
Inside vehicle	Parking/View button		<ul style="list-style-type: none"> Press and hold the Parking/View button to turn on Remote Smart Parking Assist. Also, Forward/Reverse Parking Distance warning will automatically turn on. (However, functions may differ depending on the situations. Refer to each function's description for more details in the following pages.) Press and hold the Parking/View button while Smart Parking or Smart Exit function is on to operate the function.
	Parking Safety button		<ul style="list-style-type: none"> Press the Parking Safety button while Remote Smart Parking Assist is operating to end function operation.
Smart key	Remote Start button		<ul style="list-style-type: none"> Press the Remote Start button after the door is locked with the vehicle off to start the vehicle remotely. Press the Remote Start button while Remote Operation function is operating to end function operation.
	Forward button		<ul style="list-style-type: none"> When using Remote Smart Parking function, regardless of which direction button is pressed, reverse parking is supported while the button is pressed.
	Backward button		<ul style="list-style-type: none"> When using the Remote Operation function, the vehicle moves in the direction of the button while the button is pressed.

Remote Operation

Operating order

Remote Operation operates in the following order:

1. Getting ready to remotely move forward and backward
2. Remotely moving forward and backward

1. Getting ready to remotely move forward and backward

There are two ways to operate Remote Operation function.

Method (1): Using the function with vehicle off



1. Within a certain range from the vehicle press the door lock (🔒) button on the smart key and lock all doors.
2. Press and hold the Remote Start button (🏠) within 4 seconds until the vehicle starts.

* For more details on remotely starting the vehicle, refer to "Locking/unlocking/remotely starting/remotely parking with the smart key" on page 5-6.

Method (2): Using the function with vehicle on

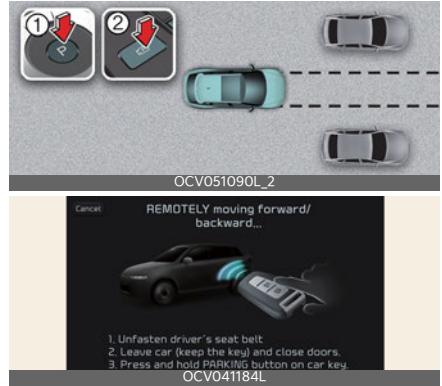

A: REMOTELY moving forward/backward...

1. Unfasten driver's seat belt.
 2. Leave car (keep the key) and close doors.
 3. Press and hold PARKING button on car key.
1. Park the vehicle in front of the space where you want to use Remote Operation function, and shift the gear to P (Park).
 2. Press and hold the Parking/View (🅇) button to turn on Smart Parking Assist. A message **Under REMOTE control** will appear on the infotainment system screen.
 3. Get out of the vehicle with the smart key and close all doors.

* NOTICE

- **Agree** must be selected on the infotainment system screen and the infotainment system has to operate properly to use Remote Operation function.

- Method (2) can be used after the vehicle has been driven above 5 km/h (3 mph).
- If the function is turned on again after parallel parking is completed by Remote Smart Parking Assist, Remote Operation function can be used with Method (2).

2. Remote Operation



1. Press and hold one of the Forward (⏩) or Backward (⏪) button on the smart key.
 - Remote Smart Parking Assist will automatically control the steering wheel, vehicle speed and gear shift. The vehicle will move in the direction of the button pressed.
 - While Remote Operation function is operating, if you let the button, the vehicle will stop and function control will pause. The function will start operating again when the button is pressed and held again.
 2. Hold down the Forward (⏩) or Backward (⏪) button until the vehicle reaches the target location.
 3. When Remote Operation is done, get in the vehicle with the smart key or press the Remote Start (⏻) button on the smart key from outside the vehicle.
 - The message will appear on the infotainment system screen. The vehicle will automatically shift to P (Park) and engage the parking brake.
- When the Remote Start (⏻) button is pressed, the vehicle will turn off. If the driver is in the vehicle, the vehicle will retain ON position.

* NOTICE

- Remote Operation can control the vehicle remotely using the smart key outside the vehicle.
- Check that all smart keys are outside the vehicle when using Remote Operation function.
- Remote Operation function will operate only when the smart key is within 4 m (13 ft.) from the vehicle. If there is no vehicle movement even when the Forward or Backward button is pressed on the smart key, check the distance to the vehicle and press the button again.
- The detecting range of the smart key may vary depending on the surroundings that are affected by radio waves such as transmission tower, broadcast station, etc.
- When remotely moving forward using method (1), it is recognized as an exit situation, and the vehicle moves 4 m (13 ft.) to check for pedestrians, animals or objects around the vehicle. After confirmation, the steering wheel is controlled according to the condition ahead.
- When remotely moving forward using method (2), it is recognized as a parking situation, and will immediately control the steering wheel according to the condition ahead to assist with entering the parking space and aligning the vehicle. However, performance may reduce depending on the pedestrians, animals, shape of

objects, location, etc. around the vehicle.

- For moving remotely backward, both method (1) and (2) aligns the steering wheel first, and then will only move the vehicle straight.

⚠ WARNING

- When using Remote Operation function, make sure that all passengers have gotten out of the vehicle.
- Before leaving the vehicle, close windows and sunroofs, and make sure the vehicle is off before locking the doors.
- If the vehicle's battery is discharged or Remote Smart Parking Assist malfunctions when parked in a narrow parking space, Remote Operation function will not operate. Always park your vehicle in a space wide enough for you to get in or out of your vehicle.
- Please note that depending on the parking space, you may not be able to exit from the space you have entered by using Remote Operation function.
- After parking, the surrounding may change due to the movement of surrounding vehicles. If this occurs, Remote Operation function may not operate.

Remote Smart Parking Assist operation status

Operation Status	Smart key LED	Hazard warning light
Under control	Green LED Continuously blinks	-
Pause	Red LED Continuously blinks	Blinks
Off	Red LED illuminates for 4 seconds and then turns off	Blinks 3 times and turns off

Operation Status	Smart key LED	Hazard warning light
Complete	Green LED illuminates for 4 seconds and then turns off	Blinks 1 time and turns off

*** NOTICE**

- Operation status by the hazard warning light may not be applicable based on the regulation of your country.
- If the smart key is not within the operating range from the vehicle (approximately 4 m (13 ft.)), the smart key LED will not illuminate or blink. Use the smart key within the operating range.

How to turn off Remote Operation function while operating

- Press the Parking/View (P/V) button or shift the gear except to P (Park) while the infotainment system screen guides the driver using method 2.
- Press the Parking Safety (P/A) button or select **Cancel** on the infotainment system screen.
- Press the Remote Start (R) button on the smart key while the vehicle is being controlled by Remote Operation function. Remote Operation function will turn off. At this time, the vehicle will turn off.
- Get on the vehicle with the smart key. Remote Operation function will turn off. At this time, the vehicle will remain on.

The function will pause in the following conditions when:

When Remote Operation function is paused, the vehicle will stop. If the condition that made the function to pause

disappears, the function may operate again.

- There is a pedestrian, animal or object in the direction the vehicle is moving
- The door or tailgate is open
- The Forward (🚗) or Backward (🚗) button is not continuously pressed
- Simultaneously pressing multiple buttons on a smart key
- The smart key is not operated within 4 m (13 ft.) from the vehicle
- Button of another smart key is pressed in addition to the operating smart key (Excluding start button)
- Blind-Spot Collision-Avoidance Assist or Rear Cross-Traffic Collision-Avoidance Assist operates while the vehicle is being controlled in the reverse direction.
- The vehicle moves 7 m (22 ft.) while the smart key is pressed with Remote Operation function (maximum travel distance per button press)

The function will cancel in the following conditions when:

When Remote Operation function is canceled, the vehicle will automatically stop, shift the gear to P (Park) and engage EPB (Electronic Parking Brake).

- The steering wheel is steered
- The gear is shifted while the vehicle is moving
- Operating EPB while the vehicle is moving
- The vehicle hood is open
- The brake pedal or accelerator pedal is depressed when all the doors are closed

- The smart key is outside the vehicle when the brake pedal is depressed while the driver's door is open
- Rapid acceleration occurs
- Vehicle skid occurs
- The wheel is stuck by an obstacle and cannot move
- Approximately 3 minutes and 50 seconds have past after Remote Operation function has started to operate
- The slope of the road exceeds the operational range
- The function is paused for more than 1 minute
- The total travel distance of the vehicle has exceeded 14 m (45 ft.) after Remote Operation function operation
- The steering wheel, gearshift, braking, and drive controls are not working normally
- There is a problem with the smart key or the smart key battery is low
- ABS, TCS or ESC system operates due to slippery road conditions
- The alarm of the Theft Alarm System sounds
- The charging door opens

Smart Parking, Remote Smart Parking

Operating order

Parking function operates in the following order:

1. Getting ready for parking
2. Searching for parking space
3. Select parking type and operating mode
4. Smart Parking
5. Remote Smart Parking

1. Getting ready for parking



1. With the vehicle turned on, depress the brake pedal and shift the gear to D (Drive) or N (Neutral).
2. Press and hold the Parking/View (P) button to turn on Remote Smart Parking Assist.

* NOTICE

- **Agree** must be selected on the infotainment system screen and the infotainment system has to operate properly to use Parking function.
- If you drive above 5 km/h (3 mph) with the vehicle on, you may use the Parking function with the gear shifted to N (Neutral).

2. Searching for parking space



A: Searching for parking space...

1 Slowly drive forward (below 20 km/h).

Slowly drive forward maintaining the distance of approximately 100 cm (40 inches) from the parked vehicles. The vehicle will search for a parking space from the side or front/rear of parked vehicle.

When searching for a parking space is complete, a message will appear on the infotainment system screen. **Select parking type** will be displayed and the selected parking space will appear on Top View screen of Surround View Monitor.

* NOTICE

- Remote Smart Parking Assist searches for parking spaces that are next to parked vehicles, or parking spaces with parked vehicles in front or rear.
- While searching for a parking space, when vehicle speed is above 20 km/h (12 mph), a message will appear on the infotainment system screen informing you to slow down. When vehicle speed is above 30 km/h (18 mph), Parking function will turn off.
- Searching for a parking space will be completed when there is enough space to move the vehicle in addition to the parking space.
- Even if an audible sound is heard to notify that searching for a parking space is complete, search completion can be canceled immediately depending on surroundings.

*** NOTICE**

- If the distance is below 50 cm (20 inches) or over 150 cm (59 inches), Remote Smart Parking Assist may not be able to search for a parking space.

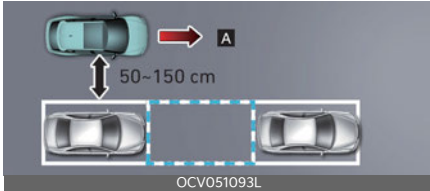

[A]: Searching for parking space

- If you do not maintain a certain distance from the parked vehicle, the performance to search for a parking space may reduce.
- Even if a diagonal parking space is searched as a parking space, parking is not assisted normally.
- Due to abnormal performance of the ultrasonic sensor or the influence of the surroundings, Parking function may not be able to search for a parking space even if there is a parking space, or may search for a space that is not suitable for parking.

3. Select parking type and operating mode

1. Parking type - Perpendicular reverse (Left/Right), Parallel reverse (Left/Right)



A: Select parking type

1 Parking type can only be selected at standstill.

With the vehicle stopped by depressing the brake pedal, touch the infotainment system screen to select the desired parking type.

*** NOTICE**

- If you continue to drive without stopping after the parking type selection screen appears, Remote Smart Parking Assist will return to the previous stage and search for a parking space.
- If Parking function is canceled unintentionally by pressing the Parking/View (P/V) button before the parking type is selected, you can return to the parking type selection stage by pressing and holding the button again while the vehicle is stopped.

⚠ WARNING

Before selecting the Parking type, the driver should check whether the parking space is suitable.

If the searched parking space by Remote Smart Parking Assist is narrow or unsuitable for parking, do not select the Parking type and move the vehicle to search for another parking space.

2. Operating mode - Remote Parking, Smart Parking



A: Operation guide

1 REMOTE Parking

2 SMART Parking

After selecting a parking type, the infotainment system screen will guide you with Remote Smart Parking function and Smart Parking function. Follow the instructions to operate Remote Smart Parking Assist.

*** NOTICE**

- Operating instructions will be displayed on the screen for each desired function you select.
- Do not take your foot off the brake pedal during the Parking function guide. When the vehicle moves, Remote Smart Parking Assist will turn off.

*** NOTICE**

A: SMART Parking



1 Take hands off steering wheel.

2 Press and hold PARKING button.

If Remote Smart Parking Assist cannot activate Remote Smart Parking function, only the Smart Parking guide will be displayed on the infotainment system screen.

4. Smart Parking



1. Press the Parking/View () button when the vehicle is stopped by depressing the brake pedal.
2. Release the brake pedal while holding the Parking/View () button.
 - Remote Smart Parking Assist will automatically control the steering wheel, vehicle speed and gear shift.
 - If you do not hold down the Parking/View button, the vehicle will

stop and function control will pause. The function will start operating again when the Parking/View button is pressed and held again.

3. Hold the Parking/View (P) button until the vehicle reaches the target parking position.
 - Message will appear on the infotainment system screen to inform you that parking is complete. The vehicle will automatically shift to P (Park) and engage the parking brake.
4. If you need to change the vehicle's position or location, manually complete parking your vehicle.

*** NOTICE**

- Smart Parking function will not operate if the door is open or the seat belt is not fastened.
- The parking location indicator is displayed on Surround View Monitor screen and is displayed until the vehicle enters the parking space for the first time by Smart Parking function.
- Vehicle speed can be adjusted by depressing the brake pedal while Smart Parking function is operating. However, the vehicle does not accelerate even when the accelerator pedal is depressed.
- Depending on parking environments, if the vehicle is stopped by a stopper, parking may be completed.

5. Remote Smart Parking



A: REMOTE Parking

- 1. Unfasten driver's seat belt.**
- 2. Leave car (keep the key) and close doors.**
- 3. Press and hold PARKING button on car key.**
 1. Shift the gear to P (Park).
 2. Get out of the vehicle with the smart key, and close all doors.
 3. Press and hold one of the Forward (F) or Backward (B) button on the smart key.
 - Remote Smart Parking Assist will automatically control the steering wheel, vehicle speed and gear shift.
 - If you do not hold down the Forward (F) or Backward (B) button, the vehicle will stop and function control will pause. The function will start operating again when the button is pressed and held again.
 4. Hold the Forward (F) or Backward (B) button on the smart key until the parking is complete.
 - When the vehicle reaches the target parking position, a message will appear on the infotainment system screen to inform you that parking is complete. The vehicle will automatically shift to P (Park), engage EPB (Electronic Parking Brake) and the vehicle will turn off.

5. If you need to change the vehicle's position or location, manually complete parking your vehicle.

*** NOTICE**

- When operating Remote Smart Parking function, make sure all smart keys are outside of the vehicle.
- Remote Smart Parking function will operate only when the smart key is within 4 m (13 ft.) from the vehicle. If there is no vehicle movement even when the Remote Forward or Backward button is pressed on the smart key, check the distance to the vehicle and press the button again.
- The detecting range of the smart key may vary depending on the surroundings that are affected by radio waves such as transmission tower, broadcast station, etc.
- The parking location indicator is displayed on Surround View Monitor screen and is displayed until the vehicle enters the parking space for the first time by Remote Smart Parking function.
- Depending on parking environments, if the vehicle is stopped by a stopper, parking may be completed.

▲ WARNING

- When using Remote Smart Parking function, make sure that all passengers have gotten out of the vehicle.
- After ending or turning off Remote Smart Parking function, before leaving the vehicle, close windows and sunroofs, and make sure the vehicle is off before locking the doors.

Smart Parking function

Operation status	Turn signal
Under control	The turn signal of the parking direction blinks until the first reverse is complete.

Operation status	Smart key LED	Hazard warning light	Turn signal
Under control	Green LED continuously blinks	-	The turn signal of the parking direction blinks until the first reverse is complete.
Pause	Red LED continuously blinks	Blinks	-
Off	Red LED illuminates for 4 seconds and then turns off	Blinks 3 times and turns off	-
Complete	Green LED illuminates for 4 seconds and then turns off	Blinks 1 time and turns off	-

*** NOTICE**

- Operation status by the hazard warning light may not be applicable based on the regulation of your country.
- If the smart key is not within the operating range from the vehicle (approximately 4m (13 ft.)), the smart key LED will not illuminate or blink. Use the smart key within the operating range.

How to turn off Parking function while operating

- Press the Parking Safety (P+▲) button or select **Cancel** on the infotainment system screen to turn off.
- Press the Parking Safety (P+▲) button in Searching for parking space and Select parking type stage.
- Shift the gear to R (Reverse) in the Searching for parking space, Select

parking type and Select operating mode stage.

- While Smart Parking function is operating, depress the brake pedal to stop the vehicle. At this time, EPB (Electronic Parking Brake) will not be engaged.
- While Smart Parking function is operating, press the Remote Start (Ω) button on the smart key.

* NOTICE

Get on the vehicle with the smart key. Remote Smart Parking function will turn off. At this time, the vehicle will remain on.

Parking function operation status

The function will pause in the following conditions when:

When Parking function is paused, the vehicle will automatically stop. If the condition that made the function to pause disappears, the function may operate again.

- Smart Parking
 - There is a pedestrian, animal or object in the direction the vehicle is moving
 - The door or tailgate is open
 - The driver's seat belt is not fastened
 - Blind-Spot Collision-Avoidance Assist or Rear-Cross Traffic Collision Assist operates while the vehicle is being controlled in the reverse direction
 - The Parking/View (P) button is not continuously pressed
 - The vehicle is stopped by depressing the brake pedal

- Remote Smart Parking
 - There is a pedestrian, animal or object in the direction the vehicle is moving
 - The door or tailgate is open
 - The Forward (F) or Backward (B) button is not continuously pressed
 - Simultaneously pressing multiple buttons on a smart key
 - The smart key is not operated within 4 m (13 ft.) from the vehicle
 - Button of another smart key is pressed in addition to the operating smart key
 - Blind-Spot Collision-Avoidance Assist or Rear-Cross Traffic Collision Assist operates while the vehicle is being controlled in the reverse direction

The function will cancel in the following conditions when:

- Smart Parking
 - When Smart Parking function is canceled, the vehicle will automatically stop, shift the gear to P (Park) and engage EPB (Electronic Parking Brake).
 - The steering wheel is steered
 - The gear is shifted while the vehicle is moving
 - Operating EPB while the vehicle is moving
 - The hood is open
 - The driver opens the door with the seatbelt unfastened
 - Rapid acceleration occurs
 - Vehicle skid occurs
 - The wheel is stuck by an obstacle and cannot move

- There are pedestrians, animals or objects at the front and rear of the vehicle at the same time
 - Approximately 3 minutes and 50 seconds have past after Smart Parking function has started to operate
 - The slope of the road exceeds the operational range
 - The function is paused for more than 1 minute
 - The steering wheel, gearshift, braking, and drive controls are not working normally
 - ABS, TCS or ESC system operates due to slippery road conditions
 - The charging door opens
- Remote Smart Parking
 - Approximately 3 minutes and 50 seconds have past after Remote Smart Parking function has started to operate
 - The slope of the road exceeds the operational range
 - The function is paused for more than 1 minute
 - The steering wheel, gearshift, braking, and drive controls are not working normally
 - There is a problem with the smart key or the smart key battery is low
 - ABS, TCS or ESC system operates due to slippery road conditions
 - The alarm of the Theft Alarm System sounds
 - The charging door opens

When Remote Smart Parking function is canceled, the vehicle will automatically stop, shift the gear to P (Park) and engage EPB (Electronic Parking Brake).

- The steering wheel is steered
- The gear is shifted
- Operating EPB while the vehicle is moving
- The hood is open
- The brake pedal or accelerator pedal is depressed when all the doors are closed
- The smart key is outside the vehicle when the brake pedal is depressed while the driver's door is open.
- Rapid acceleration occurs
- Vehicle skid occurs
- The wheel is stuck by an obstacle and cannot move
- There are pedestrians, animals or objects at the front and rear of the vehicle at the same time

Smart Exit

Operating order

Smart Exit function operates in the following order:

1. Getting ready for exit
2. Checking space
3. Select exit direction
4. Smart Exit

1. Getting ready for exit



1. With the vehicle turned on, depress the brake pedal and shift the gear to P (Park) or N (Neutral).

- Press and hold the Parking/View (P) button to turn on Remote Smart Parking Assist.

*** NOTICE**

- Agree** must be selected on the infotainment system screen and the infotainment system has to operate properly to use Smart Exit function.
- Drive below 5 km/h (3 mph) with the vehicle on and shift the gear to N (Neutral), Smart Exit function can be used.
- If the function is turned on again after parallel parking is completed by Remote Smart Parking Assist, Smart Exit function can be used.

2. Checking space



A: Checking space...

1 Stop the vehicle.

- When the vehicle is stopped by depressing the brake pedal, the vehicle sensors will detect the distance from nearby objects and check for space to exit.
- When checking for space is complete, a message will appear on the infotainment system screen with an audible sound to notify the search is complete.

⚠ WARNING

- While checking for space, if there is a risk of collision with pedestrian, animal or object in the direction of vehicle exit, for your safety, Smart Exit function can be turned off.
- Even if check for space is completed, objects in the blind spot area cannot be detected by the sensors. The driver must directly check the blind spot area and continue using the function.

*** NOTICE**

Due to abnormal performance of the ultrasonic sensor or the influence of the surroundings, Parking function may not be able to search for a parking space even if there is a parking space, or may search for a space that is not suitable for parking.

3. Select exiting direction



A: Select exiting direction

1 Direction can only be selected at standstill.

- With the vehicle stopped by depressing the brake pedal, the infotainment system screen displays the possible directions for parallel exit.
- Touch the infotainment system screen to select the desired exit direction.

⚠ WARNING

Before selecting the Exit Direction, the driver should check whether the space for exit is suitable. If the searched exit space by Remote Smart Parking Assist is narrow or unsuitable (surrounding vehicles are parked vertically, etc.), do not use the Smart Exit function.

4. Smart Exit



A: SMART Exiting

- 1. Take hands off steering wheel.**
- 2. Press and hold PARKING button.**

1. Press the Parking/View (P) button when the vehicle is stopped by depressing the brake pedal.
 - When the brake pedal is released, Remote Smart Parking Assist will automatically control the steering wheel, vehicle speed and gearshift.
 - While Smart Exit function is operating, if you do not hold down the Parking/View button, the vehicle will stop and function control will pause. The function will start operating again when the Parking/View button is pressed and held again.
2. Hold the Parking/View (P) button until the vehicle reaches the target exit location. When the vehicle reaches the target exit location, a message will appear on the infotainment system screen to inform you that exit is complete.

- When the vehicle reaches the target exit location, a message will appear on the infotainment system screen to inform you that exit is complete.

*** NOTICE**

- Smart Exit function will not operate if the door is open or the seat belt is not fastened.
- Vehicle speed can be adjusted by depressing the brake pedal while Smart Exit function is operating. However, the vehicle does not accelerate even when the accelerator pedal is depressed.
- If exit is completed while depressing the brake pedal, Smart Exit function will complete with the gear in D (Drive).
- If exit is completed while depressing the accelerator pedal, you must take your foot off the accelerator pedal once for the accelerator pedal to operate.
- If there is no vehicle operation such as depressing the brake pedal or accelerator pedal within 4 seconds after exit is complete, the vehicle will automatically shift to P (Park) and engage EPB (Electronic Parking Brake).
- After Exit function is complete, always check the surroundings before driving.

Smart Exit operation status

Operation status	Turn signal
Under control	The turn signal of the exit direction blinks until the exit is complete or Smart Exit is canceled.

How to turn off Smart function while operating

- Press the Parking/View (P) button in the following stage:
 - Checking space
 - Select exit direction
- Shift the gear to R (Reverse) in the following stage:
 - Checking space
 - Select exit direction
- Press the Parking Safety (P) button or select **Cancel** on the infotainment system screen to turn off Exit function.
- While Smart Exit function is operating, if the vehicle is stopped by depressing the brake pedal, and the gear is shifted, Exiting function will turn off. At this time, EPB (Electronic Parking Brake) will not be engaged.

The function will pause in the following conditions when:

When Exit function is paused, the vehicle will stop. If the condition that made the function to pause disappears, the function may operate again.

- There is a pedestrian, animal or object in the direction the vehicle is moving
- The door or tailgate is open
- The driver's seat belt is not fastened
- Blind-Spot Collision-Avoidance Assist or Rear-Cross Traffic Collision Assist operates while the vehicle is being controlled in the reverse direction
- The Parking/View (P) button is not continuously pressed
- The vehicle is stopped by depressing the brake pedal

The function will cancel in the following conditions when:

When Smart Exit function is canceled, the vehicle will automatically stop, shift the gear to P (Park) and engage EPB (Electronic Parking Brake).

- Smart Exit
 - The steering wheel is steered
 - The gear is shifted while the vehicle is moving
 - Operating EPB while the vehicle is moving
 - The hood is open
 - The driver opens the door with the seatbelt unfastened
 - Rapid acceleration occurs
 - Vehicle skid occurs
 - The wheel is stuck by an obstacle and cannot move
 - There are pedestrians, animals or objects at the front and rear of the vehicle at the same time
 - Approximately 3 minutes and 50 seconds have past after Smart Exit function has started to operate
 - The slope of the road exceeds the operational range
 - The function was paused for more than 1 minute
 - The steering wheel, gearshift, braking, and drive controls are not working normally
 - ABS, TCS or ESC system operates due to slippery road conditions
 - The charging door opens

Remote Smart Parking Assist malfunction and limitations

Remote Smart Parking Assist malfunction

Remote Smart Parking Assist check

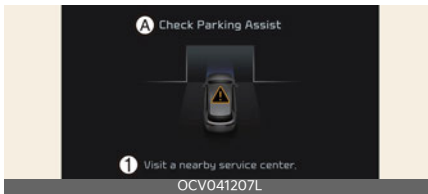

A: Check Parking Assist

1 Visit a nearby service center.

When Remote Smart Parking Assist is not working properly, the **Check Parking Assist** warning message will appear on the infotainment system screen. If the message appears, stop using the function, and we recommend that the function be inspected by an authorized Kia dealer/service partner.

Remote Smart Parking Assist canceled

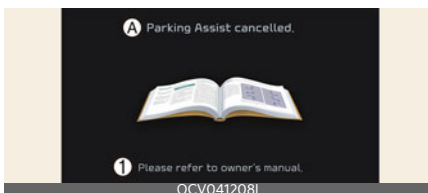

A: Parking Assist cancelled.

1 Please refer to owner's manual.

When Remote Smart Parking Assist is operating, the function can be canceled, and the **Parking Assist Cancelled** warning message may appear regardless of the parking order. Other mes-

sages may appear depending on the situations. Follow the instructions provided on the infotainment system screen while parking your vehicle with Remote Smart Parking Assist. Always look around and pay attention when using the function.

Remote Smart Parking Assist standby

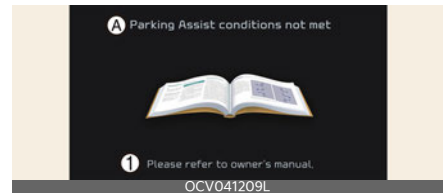

A: Parking Assist conditions not met

1 Please refer to owner's manual.

When **Parking Assist conditions not met** message appears, when Parking/View (Ⓜ) button has been pressed and held, Remote Smart Parking Assist is in standby. After a while, press and hold the Parking/View (Ⓜ) button again to see if the function works.

The message appears even when the smart key's battery is low. Check the smart key battery level.

Limitations of Remote Smart Parking Assist

In the following circumstances, function performance to park or exit the vehicle may be limited, there may be a risk of collision, or Remote Smart Parking Assist may turn off. Park or exit the vehicle manually if necessary.

- An object is attached to the steering wheel
- The vehicle is installed with a snow chain, spare tire or different size wheel

- Tire pressure is lower or higher than the standard tire pressure
- Your vehicle is loaded with cargo longer or wider than your vehicle or a trailer is connected to your vehicle
- There is a problem with the wheel alignment
- Your vehicle is leaned severely to one side
- Your vehicle is equipped with a trailer hitch
- The license plate is installed differently from the original location
- There is a person, animal or object above or below the ultrasonic sensor when Remote Smart Parking Assist is activated
- The parking space is curved or diagonal
- There is an obstacle such as a person, animal or object (trash can, bicycle, motorcycle, shopping cart, narrow pillar etc.) near the parking space
- There is a circular pillar or narrow pillar, or a pillar surrounded by objects such as fire extinguisher, etc. near the parking space
- The road surface is bumpy (curbstone, speed bump, etc.)
- The road is slippery
- The parking space is near a vehicle with higher ground clearance or big, such as a truck, etc.
- The parking space is Inclined
- There is heavy wind
- Operating Remote Smart Parking Assist on uneven roads, gravel roads, bushes, etc.
- The performance of the ultrasonic sensor is affected by extremely hot or cold weather

- The ultrasonic sensor is covered with snow or water
- An object that generates ultrasonic waves is nearby
- A wireless device with a transmission function operates near the ultrasonic sensors
- Your vehicle is affected by another vehicle's Parking Distance Warning
- The sensor is mounted or positioned incorrectly by an impact to the bumper
- When the ultrasonic sensor cannot detect the following objects: Sharp or slim objects, such as ropes, chains or small poles
- Objects smaller than 100 cm (40 inches) in length and narrower than 14 cm (6 inches) in diameter
- Objects which tend to absorb sensor frequency, such as clothes, spongy material or snow

Remote Smart Parking Assist may not operate normally under the following circumstances:

- Parking on inclines



Park manually when parking on inclines.

- Parking in snow

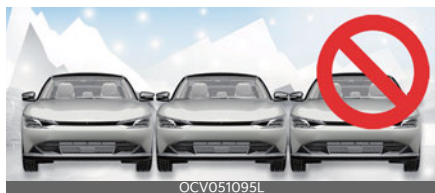

Snow may interfere with sensor operation, or Remote Smart Parking Assist may cancel if the road is slippery while parking.

- Parking on uneven road



Remote Smart Parking Assist may cancel when the vehicle slips, or the vehicle cannot move due to road conditions such as pebbles or fragmented stones.

- Parking behind a truck



Do not use Remote Smart Parking Assist around vehicles with higher ground clearance, such as a bus, truck, etc. It may lead to an accident.

- Parking near a pillar



Remote Smart Parking Assist performance may reduce or collision with an obstacle may occur when there is a narrow object, circular pillar, square pillar, or a pillar surrounded by objects such as a fire extinguisher, etc. near

the parking space. The driver should park the vehicle manually.

- Parking in a parking space with a vehicle on one side only

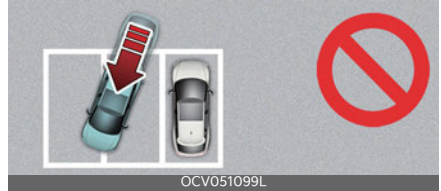

If Remote Smart Parking Assist is used, when parking in a parking space with a vehicle only on one side, your vehicle may cross the parking line to avoid the parked vehicle.

- Parking diagonal



Remote Smart Parking Assist does not provide diagonal parking. Even if your vehicle was able to enter the parking space, do not use the function because the function cannot operate normally.

- Leaving a parking space near a wall or parking in a narrow space



- Remote Smart Parking Assist may not operate properly when leaving a parking space that is narrow and near a wall. Always check for

pedestrians, animals, objects while leaving.

- For your safety, Remote Smart Parking Assist does not search for parking spaces at areas with narrow parking spaces that are narrower than the minimum space required for parking.

⚠ WARNING

- The driver is responsible for safe parking and exit when using Remote Smart Parking Assist.
- When using Remote Smart Parking Assist, stay out of the way in the direction the vehicle moves for your safety.
- Always check surroundings when using Remote Smart Parking Assist. You may collide with pedestrians, animals, or objects if they are near the sensor or are in the sensor's blind spot area.
- A collision may occur if a pedestrian, animal, or object suddenly appears while Remote Smart Parking Assist is operating.
- Do not use Remote Smart Parking Assist when under the influence of alcohol.
- Do not let children or other people to use the smart key.
- If Remote Smart Parking Assist is used continuously for a long period, it may adversely affect Remote Smart Parking Assist performance.
- Remote Smart Parking Assist may not operate normally if the vehicle needs wheel alignment adjustment such as when the vehicle tilts to one side. We recommend that the vehicle be inspected by an authorized Kia dealer/service partner.

- Noise may be heard when braking occurs by Remote Smart Parking Assist or when the brake pedal is depressed by the driver.
- Remote Smart Parking Assist may suddenly apply the brake to avoid collision.
- Use Remote Smart Parking Assist only in a parking space that is large enough for the vehicle to move safely.

*** NOTICE**

- If the 3rd stage warning (continuous beep) of the Forward/Reverse Parking Distance Warning sounds while Remote Smart Parking Assist is operating, it means the obstacle detected is close to your vehicle. At this time, Remote Smart Parking Assist will temporarily stop operating. Make sure there are no pedestrians, animals, or objects around your vehicle.
- Depending on brake operation, the stop lights may come on while the vehicle is moving.
- If the vehicle is remotely started that has been parked in cold weather for a long time, the operation of Remote Smart Parking function may be delayed or canceled depending on vehicle condition.

Declaration of conformity (if equipped)

The radio frequency components (Front Radar) complies:

For Europe and countries subject to CE certification



OGL3051237L

Model : MRR-30

Hereby MRR-30 has been so constructed that it can be operated in at least one Member State without infringing applicable requirements of use of radio spectrum. (RED article 10.2)

Hereby, Mando Corp declares that the radio equipment type MRR-30 is in compliance with Directive 2014/53/EU.

The full text of the EU declaration of conformity is available at the following internet address:

<https://www.mando.com/rnd/rnd04.jsp>

OGL3051238L

For Taiwan



OGL3051239L

CCAF19LP2840T0

(1) 經型式認證合格之低功率射頻電機，非經許可，公司、商號或使用者均不得擅自變更頻率、加大功率或變更原設計之特性及功能。
 (2) 低功率射頻電機之使用不得影響飛航安全及干擾合法通信；經發現有干擾現象時，應立即停用，並改善至無干擾時方得繼續使用。前項合法通信，指依電信法規定作業之無線電通信。低功率射頻電機須忍受合法通信或工業、科學及醫療用電波輻射性電機設備之干擾。

(1) Without permission granted by NCC, any company, enterprise, or user is not allowed to change frequency, enhance transmitting power or alter original characteristic as well as performance to a approved low power radio-frequency devices.

(2) The low power radio-frequency devices shall not influence aircraft security and interfere legal communications: If found, the user shall cease operating immediately until no interference is achieved. The said legal communications means radio communications is operated in compliance with the Telecommunications Act.

The low power radio-frequency devices must be susceptible with the interference from legal communications or ISM radio wave radiated devices.

OGL3051240L

For Australia



OGL3051241L

For Serbia



OGL3051242L

For Oman

OMAN - TRA
 TRA/TA-R/8804/19
 D182437
 OGL3051243L

For Moldova



OGL3051244L

For Ukraine



UA RF: 3MAND3MRR
 OGL3051245L

26. Manufacturers should ensure that radio equipment is accompanied by instructions and safety information in accordance with the law on the use of languages.

Instructions should include the information necessary to use the radio equipment according to its purpose. Such information contains, in the presence of a description of the components and accessories, including software that allows the radio equipment to work for its intended purpose. Such instructions and safety instructions, as well as any labeling, must be clear, understandable and legible.

An instruction for radio equipment intended to emit radio waves must additionally contain:
 band (bands) of radio frequencies, in which (in which) the radio equipment operates;
 the maximum radiation power in the band (s) of radio frequencies, in which (in which) radio equipment is operating.

OGL3051246L

For UAE



TRA – United Arab Emirates	
Dealer ID :	_____
TA RTTE :	_____
Model :	_____
Type :	_____



REGISTERED No: ER77591/19
 DEALER No.: DA58500/16
 OGL3051247L

For Brazil



XXXXX-XX-XXXXX
 00084-20-09644
 OGL3051248L

For Ghana

NCA Approved : SRO-1M-7E4-X19
 OGL3051250L

For Singapore

**Complies with
 IMDA Standards
 [Dealer's Licence No.]**

Dealer's Licence : DA107248
 OGL3051249L

For Russia



OGL3051251L

For Malaysia



HIDF16000136
OGL3051252L

For Jordan

Model : MRR-30
Serial No :
Year of Manufacture :
OGL3051253L

For Mexico

IFETEL : RCPMAMR20-0338

"La operación de este equipo está sujeta a las siguientes dos condiciones:
(1) es posible que este equipo o dispositivo no cause interferencia perjudicial y
(2) este equipo o dispositivo debe aceptar cualquier interferencia, incluyendo la que pueda causar su operación no deseada."
and RCPMAMR20-0338
OGL3051254L

For Israel

Ministry of Communication permit number :
51-71611
OGL3051255L

For Morocco

Número d'agrément :MR 22027 ANRT 2019
Date d'agrément : 2020-01-09
OGL3051256L

For Argentina



OGL3051257L

For Philippines



Type Approved
No. ESD-2021666C
OGL3051258L

For Paraguay



+ NR : 2020-02-I-0114
OGL3051259L

For Uzbekistan



OGL3051260L

For Benin

Numero d'agrement:
070/ARCEP/SE/DAR/DJPC/2020
Date d'agrement: 18 MARS 2020:
OGL3051261L

For Thailand



CLASS A
NBTC ID : A57015-19
OGL3051262L

The radio frequency components (Front Corner Radar/Rear Corner Radar) complies: (if equipped)

For Mexico

IFETEL: RCPAPH519-1602

"La operación de este equipo está sujeta a las siguientes dos condiciones:
(1) es posible que este equipo o dispositivo no cause interferencia perjudicial y (2) este equipo o dispositivo debe aceptar cualquier interferencia, incluyendo la que pueda causar su operación no deseada."

OGL3051265L

For Ukraine



UA RF: 1APTV H5TR
OGL3051266L

справжнім (найменування виробника) заявляє, що тип радіобладнання (позначення типу радіобладнання) відповідає Технічному регламенту радіобладнання:
повний текст декларації про відповідність доступний на веб-сайті за такою адресою:
www.aptv.com/automotive-homologation
OGL3051267L

For Ghana

NCA approved: ZRO-M8-7E3-249
OGL3051268L

For Republic of South Africa



TA-2019/1524
APPROVED
OGL3051269L

For Japan

This device is granted pursuant to the Japanese Radio Law
under the grant ID n° : 203-JN1053
This device should not be modified (otherwise the granted designation number will become invalid)
本製品は、電波法に基づく特定無線設備の技術基準適合証明を受けております。認証番号: 203-JN1053
本製品の改造は禁止されています。(適合証明番号などが無効となります。)
OGL3051270L

For Serbia



For Singapore

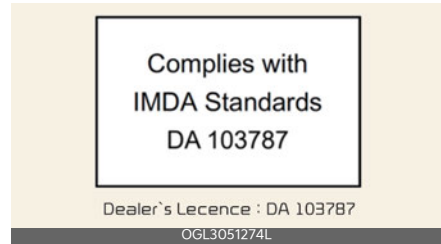

For Paraguay



For Europe and CE certified countries

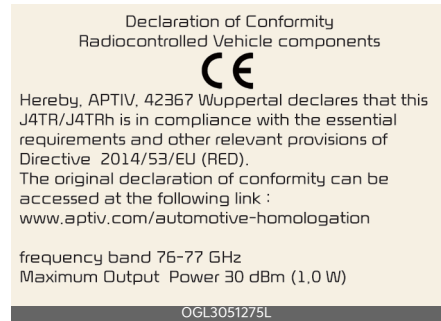

For Malaysia



For Thailand



For Israel

14. הוראת משרד התעבורה הישראלי
 לפי החוקים ודבר היבוא של אריות חרבות של המוצר יודבק מדבקה, בה לרית רשום כי:
 א. השימוש במכשיר חוץ על בסיס ימימי- ופסור משרד הפעלה הארצית
 ב. רק "פעולה בטיח" לשימוש נוסף של הלוחם בלבד, היעדר סכר משרד הפעלה הארצית.
 ג. אסור להחליף את האנטנה הקבוצית של המכשיר, ולא לפנות בו כל שינוי סכר אחר.
 תקן מספר : 63-67459
 א. השימוש במכשיר חוץ על בסיס "משני" אסור משרד הפעלה הארצית.
 ב. רק "פעולה בטיח" לשימוש נוסף של הלוחם בלבד, היעדר סכר משרד הפעלה הארצית.
 ג. אסור להחליף את האנטנה הקבוצית של המכשיר, ולא לפנות בו כל שינוי סכר אחר.
 ד. האישור הולל תמך אך ורק עבור צד ארצות, הפועל "operating frequencies of the device"
 בתנאים נדרשים של "output power of the device"
 OGL3051277L

For Brazil



XXXXX-XX-XXXXX
 13265-20-12227
 OCV051233L

Este equipamento opera em caráter secundário, isto é, não tem direito à proteção contra interferência prejudicial, mesmo de estações do mesmo tipo, e não pode causar interferência a sistemas operando em caráter primário.
 OCV051234L

For Taiwan



OGL3051239L

CCAF20LP2330T5

電信法第 4B 條, 低功率電波輻射性電機管理辦法
 第十二條
 經型式認證合格之低功率射頻電機, 非經許可, 公司、商號或使用者均不得擅自變更頻率、加大功率或變更原設計之特性及功能。
 第十四條
 低功率射頻電機之使用不得影響飛航安全及干擾合法通信; 經發現有干擾現象時, 應立即停用, 並改善至無干擾時方得繼續使用。
 前項合法通信, 指依電信法規定作業之無線電通信。低功率射頻電機須忍受合法通信或工業、科學及醫療用電波輻射性電機設備之干擾。
 Article 12
 Without permission, any company, firm or user shall not alter the frequency, increase the power, or change the characteristics and functions of the original design of the certified lower power frequency electric machinery.
 Article 14
 The application of low power frequency electric machineries shall not affect the navigation safety nor interface a legal communication, if an interference is found, the service will be suspended until improvement is made and the interference no longer exist.
 OCV051235L

For UAE



TRA
 REGISTERED No:
 ER78239/20
 DEALER No:
 DA0062437/11
 OCV051236L

For Jordan

TRC/31/7635/2020
 OCV051237L

Special driving conditions

If driving conditions deteriorate due to poor weather or road conditions, you should pay even more attention than usual.

Hazardous driving conditions

When hazardous driving conditions are encountered, such as water, snow, ice, mud, sand, or similar hazards, follow these suggestions:

- Drive cautiously and allow extra distance for braking.
- Avoid sudden braking or steering.
- Do not pump the brake pedal on a vehicle equipped with ABS.
- If stalled in snow, mud, or sand, use second gear. Accelerate slowly to avoid spinning the drive wheels.
- Use sand, rock salt, or other nonslip material under the drive wheels to provide traction when the vehicle is stuck in ice, snow, or mud.

Reducing the risk of a rollover

This multi-purpose passenger vehicle is defined as a Sports Utility Vehicle (SUV). Utility vehicles have a significantly higher rollover rate than other types of vehicles. SUVs have higher ground clearance and narrower track to make them capable of performing in a wide variety of off-road applications.

Specific design characteristics give them a higher center of gravity than ordinary vehicles. An advantage of the higher ground clearance is a better view of the road, which allows you to anticipate problems.

They are not designed for cornering at the same speeds as conventional passenger vehicles, any more than low-

slung sports vehicles are designed to perform satisfactorily in off-road conditions. Due to this risk, driver and passengers are strongly recommended to buckle their seat belts.

In a rollover crash, an unbelted person is significantly more likely to die than a person wearing a seat belt. There are precautionary measures that a driver can take to reduce the risk of rollover.

If possible, avoid sharp turns and abrupt maneuvers, do not load your roof rack with heavy cargo, and never modify your vehicle in any way.

WARNING

- Your vehicle is equipped with tires designed to provide safe ride and handling capability. Do not use tires and wheels that are different in size and type from the originally installed ones. It can affect the safety and performance of your vehicle, which could lead to steering failure or rollover and serious injury. When replacing the tires, be sure to equip all four tires with the tire and wheel of the same size, type, tread, brand and load-carrying capacity.
- As with other Sports Utility Vehicle (SUV), failure to operate this vehicle correctly may result in loss of control, an accident or vehicle rollover.
 - Utility vehicles have a significantly higher rollover rate than other types of vehicles.
 - Specific design characteristics (higher ground clearance, narrower track, etc.) give this vehicle a higher center of gravity than ordinary vehicles.
 - A SUV is not designed for cornering at the same speeds as conventional vehicles.

- Avoid sharp turns and abrupt maneuvers.
- In a rollover crash, an unbelted person is significantly more likely to die than a person wearing a seat belt. Make sure everyone in the vehicle is properly buckled up.

Rocking the vehicle

If it is necessary to rock the vehicle to free it from snow, sand, or mud, first turn the steering wheel right and left to clear the area around your front wheels. Then, shift back and forth between R (Reverse) and any forward gear position.

Do not race the vehicle, and spin the wheels as little as possible. If you are still stuck after a few tries, have the vehicle pulled out by a tow vehicle to avoid vehicle overheating and possible damage to the reduction gear.

WARNING

Do not attempt to rock the vehicle if people or objects are nearby. The vehicle may suddenly move forward or backwards as it becomes unstuck.

CAUTION

- Prolonged rocking may cause vehicle overheating, reduction gear damage or failure, and tire damage.
- Do not spin the wheels, especially at speeds more than 56 km/h (35 mph). Spinning the wheels at high speeds when the vehicle is stationary could overheat and damage tires, and the rotating wheels may fly away and injure bystanders.

* NOTICE

The Electronic Stability Control (ESC) should be turned OFF prior to rocking the vehicle.

Smooth cornering

Avoid braking or gear changing while cornering, especially when the road is wet. Ideally, corners should always be negotiated with gentle acceleration. If you follow these suggestions, tire wear will be kept to a minimum.

Driving at night

Because night driving presents more hazards than driving in the daylight, here are some important tips to remember:

- Slow down and keep more distance between you and other vehicles as it may be more difficult to see at night, especially in areas where there are no street lights.
- Adjust your mirrors to reduce the glare from other driver's headlamps.
- Keep your headlamps clean and properly aimed. (On vehicles not equipped with the automatic headlamp aiming feature.) Dirty or improperly aimed headlamps will make it much more difficult to see at night.
- Avoid staring directly at the headlamps of oncoming vehicles. You could be temporarily blinded, and it will take several seconds for your eyes to readjust to the darkness.

Driving in the rain

Rain and wet roads can make driving dangerous, especially if you are not prepared for the slick surface.

Here are a few things to consider when driving in the rain:

- A heavy rainfall will make it harder to see and will increase the distance needed to stop your vehicle, so slow down.
- Keep your windshield-wiping equipment in good shape. Replace your windshield wiper blades when they show signs of streaking or missing areas on the windshield.
- If your tires are not in good condition, having to stop quickly on a wet surface can cause a skid and possibly lead to an accident. Be sure your tires are in good shape.
- Turn on your headlamps to make it easier for others to see you.
- Driving too fast through large puddles can affect your brakes. If you must drive through puddles, try to go through them slowly.
- If you believe you got your brakes wet, apply them lightly while driving until normal brake operation returns.

Hydroplaning

If the road is wet enough and you are going fast enough, your vehicle may have little or no contact with the road surface and actually ride on the water. The best advice is to SLOW DOWN when the road is wet.

The risk of hydroplaning increases as the depth of tire tread decreases, refer to "Tire replacement" on page 8-17.

Driving in flooded areas

Avoid driving through flooded areas unless you are sure the water is no higher than the bottom of the wheel hub. Drive through any water slowly. Allow adequate stopping distance as brake performance may be affected.

After driving through water, dry the brakes by gently applying them several times while the vehicle is moving slowly.

If the brake system is wet and has reduced braking effect or frequent sounds when braking, adjust the setting for the regenerative braking to '0' speed with paddle shifter and apply the brake pedal lightly several times. Maintain a safe distance to dry the brake system.

Setting the regenerative braking to '0' may reduce efficiency while braking several times for brake performance, but this is normal. The regenerative braking system will be normally operated afterwards.

Highway driving

Tires

Adjust the inflation pressures of the tires in accordance with their specifications. Low tire inflation pressures will result in overheating and possible failure of the tires.

Avoid using worn or damaged tires since they may provide reduced traction or fail completely.

Never exceed the maximum tire inflation pressure shown on the tires.

WARNING

- Always check the tires for proper inflation before driving. Underinflated or overinflated tires can cause poor handling, loss of vehicle control, and sudden tire failure, leading to accidents, injuries, and even death. For proper tire pressures, refer to "Tires and wheels" on page 9-4.
- Always check the tire tread before driving your vehicle. Worn-out tires can result in loss of vehicle control. Worn-out tires should be replaced as soon as possible. For further information and tread limits, refer to "Tires and wheels" on page 8-15.

Coolant and high voltage battery

Driving at higher speeds on the highway consumes more electric energy and is less efficient than driving at a slower, more moderate speed. Maintain a moderate speed in order to conserve electric energy when driving on the highway.

Be sure to check both the coolant level and the electric energy level before driving.

Winter driving

Severe weather conditions in the winter result in greater wear and other problems.

To minimize the problems of winter driving, you should follow these suggestions:

- * Snow tires and tire chains for the national language (Icelandic), see the Appendix.

Snowy or icy conditions

To drive your vehicle in deep snow, it may be necessary to use snow tires or to install tire chains on your tires.

If snow tires are needed, it is necessary to select tires of the size and type equivalent to the tires originally installed. Failure to do so may adversely affect the safety and handling of your vehicle. Furthermore, speeding, rapid acceleration, sudden brake applications, and sharp turns are potentially very hazardous practices.

During deceleration, use vehicle braking to the fullest extent. Sudden brake applications on snowy or icy roads may cause skids to occur. You need to keep sufficient distance between your vehicle and the one in front. Also, apply the brake gently. Note that installing tire chains on the tires will provide greater driving force, but will not prevent side skids.

Summer tires (if equipped)

- Summer tires are used to maximize the driving performance on dry roads.
- If the temperature is below 7°C or you are driving on snowy or icy roads, the summer tires lose their brake performance and traction as the tire grip weakens significantly.

- If the temperature is below 7°C or you are driving on snowy or icy roads, mount snow tires or all-season tires of the same size with your vehicle's standard tire for safe driving. Both snow and all-season tires have M+S markings.
- When using the M+S tires, use tires with the same tread produced by the same manufacturer for safe driving.
- When driving with the M+S tires with the lower maximum allowable speed than that of the vehicle's standard summer tire, be careful not to exceed the speed allowed for the M+S tires.

Snow tires

If you mount snow tires on your vehicle, make sure they are radial tires of the same size and load range as the original tires. Mount snow tires on all four wheels to balance your vehicle's handling in all weather conditions. Keep in mind that the traction provided by snow tires on dry roads may not be as high as the traction provided by the tires originally installed on your vehicle. You should drive cautiously even when the roads are clear. Check with the tire dealer for maximum speed recommendations.

Do not install studded tires without first checking all applicable regulations for possible restrictions on their use.

⚠ WARNING

Snow tires should be equivalent in size and type to the vehicle's standard tires. Otherwise, the safety and handling of your vehicle may be adversely affected.

Tire chains

Fabric type



Because the sidewalls of radial tires are thinner, they can be damaged by mounting some types of snow chains on them. Therefore, the use of snow tires is recommended instead of snow chains. Do not mount tire chains on vehicles equipped with aluminum wheels; snow chains may cause damage to the wheels.

Damage to your vehicle caused by improper snow chain use is not covered by your vehicle manufacturer's warranty.

When using tire chains, attach them to the drive wheels as follows.

- Rear wheel drive vehicle moves the rear wheel as a power source. Thus, snow chains must be mounted to rear tires.
- All wheel drive vehicle must mount snow chains to rear tires only. In this situation, minimize the driving distance in order to prevent damage to the all-wheel drive system.
- After mounting snow chains, drive slowly. If you hear noise caused by chains contacting the body, slow down until the noise stops and remove the chain as soon as you begin driving on cleared roads to prevent damage.
- Chains of the wrong size or which are improperly installed can damage your vehicle's brake lines, suspension,

body, and wheels. Therefore, when installing snow chains, follow the manufacturer's instructions and mount them as tightly possible. Drive slowly with chains installed, staying under 30 km/h (20 mph).

- Install tire chains that meet the specifications of each tire size to prevent damage your vehicle.
 - Both 19 and 20-inch tires use fabric snow chain.

⚠ CAUTION

- Make sure the snow chains are the correct size and type for your tires. Incorrect snow chains can cause damage to the vehicle body and suspension and may not be covered by your vehicle manufacturer warranty. Also, the snow chain connecting hooks may be damaged from contacting vehicle components causing the snow chains to come loose from the tire. Make sure the snow chains are SAE class "S" certified.
- Always check chain installation for proper mounting after driving approximately 0.5 to 1 km (0.3 to 0.6 miles) to ensure safe mounting. Retighten or remount the chains if they are loose.

Check the battery and cables

Winter places additional burden the battery system. Visually inspect the battery and cables as described in section 8. Have the level of charge in your battery checked by a professional workshop. Kia recommends visiting an authorized Kia dealer/service partner.

To keep the locks from freezing

To keep the vehicle's locks from freezing, squirt an approved de-icer fluid or glycerine into the key openings. If a lock is covered with ice, squirt it with an approved de-icing fluid to remove the ice. If the lock is frozen internally, you may be able to thaw it out by using a heated key. Handle the heated key with care to avoid injury.

Use an approved window washer anti-freeze for the window washer system

To keep the water in the window washer system from freezing, add an approved window washer anti-freeze solution in accordance with instructions on the container. Window washer anti-freeze is available from an authorized Kia dealer/service partner and most auto parts outlets. Do not use coolant or other types of anti-freeze as these may damage the paint finish.

Do not let your parking brake freeze

Under some conditions, your parking brake can freeze in the applied position. This is most likely to happen when there is an accumulation of snow or ice around or near the rear brakes or if the brakes are wet. If there is risk of the parking brake freezing, temporarily apply it with the P (Park) gear position selected. Block the rear wheels in advance as well so that the vehicle cannot roll. Then, release the parking brake.

Do not let ice or snow accumulate underneath

Under some conditions, snow and ice can build up under the fenders and interfere with the steering. When driving in severe winter conditions where this may happen, you should periodically check underneath the vehicle to make sure the movements of the front wheels and the steering components are not obstructed.

Carry emergency equipment

Depending on the severity of the weather, you should carry appropriate emergency equipment. Some of the items you may want to carry include tire chains, tow straps or chains, flashlight, emergency flares, sand, shovel, jumper cables, window scraper, gloves, ground cloth, coveralls, blanket, etc.

Do not place objects or materials in the motor compartment

Putting objects or materials in the motor compartment may cause an motor failure. Such damage will not be covered by the manufacturer's warranty.

Trailer towing (if equipped)

If you are considering towing with your vehicle, you should first check with the country's department of motor vehicles to determine their legal requirements.

Since laws vary, the requirements for towing trailers, other vehicles, and apparatus may differ. Kia recommends to ask an authorized Kia dealer/service partner.

Your vehicle can tow a trailer. To identify what the vehicle trailering capacity is for your vehicle, refer to "Weight of the trailer" on page 6-198 that appears later in this section.

Remember that trailer towing is different from simply driving your vehicle by itself. Trailering means changes in handling, durability, and electric energy economy. Successful, safe trailer towing requires correct equipment, which has to be used properly.

This section contains many time-tested and important trailer-towing tips and safety rules. Many of these are important for your safety and that of your passengers. Please read this section carefully before towing a trailer.

WARNING

- If you don't use the correct equipment and drive improperly, you can lose control when you pull a trailer. For example, if the trailer is too heavy, the brakes may not work well - or even at all. You and your passengers could be seriously or fatally injured. Pull a trailer only if you have followed all the steps in this section.
- Before towing, make sure the total trailer weight, gross combination weight, gross vehicle weight, gross axle weight and trailer tongue load are all within the limits.

⚠ CAUTION

Pulling a trailer improperly can damage your vehicle and result in costly repairs not covered by your warranty. To pull a trailer correctly, follow the advice in this section.

*** NOTICE**

- The mounting hole for hitches are located on both sides of the underbody behind the rear tires.
- **For Europe**
 - The technically permissible maximum load on the rear axle(s) may be exceeded by not more than 15% and the technically permissible maximum laden mass of the vehicle may be exceeded by not more than 10% or 100 kg (220.4 lbs), whichever value is lower. In this case, do not exceed 100 km/h (62.1 mph) for vehicle of category M1 or 80 km/h (49.7 mph) for vehicle of category N1.
 - When towing a trailer, the additional load imposed at the trailer coupling device may cause the rear tire maximum load ratings to be exceeded, but not by more than 15%. In such a case, do not exceed 100km/h, and the rear tire pressure should be at least 20 kPa(0.2 bar) above the tire pressure(s) as recommended for normal use (i.e. without a trailer attached).
- * M1: passenger vehicle (9-seater or under)
- * N1: commercial vehicle (3.5 ton or under)

Hitches

It is important to have the correct hitch equipment. Crosswinds, large trucks going by, and rough roads are just a few reasons why you will need the right hitch. Here are some rules to follow:

- Do you have to make any holes in the body of your vehicle when you install a trailer hitch? If you do, be sure to seal the holes when removing the hitch later.
If you don't seal them, dirt and water can get into your vehicle.
- The bumpers on your vehicle are not intended for hitches. Do not attach rental hitches or other bumper-type hitches. Use only a frame-mounted hitch that does not attach to the bumper.
- Any part of the rear number plate or lighting devices of the vehicle must not be obscured by the mechanical coupling device. If the rear number plate and/or lighting devices can be obscured partially by any part of the mechanical coupling device, mechanical coupling devices that can not be easily removed or repositioned without use of any tool, except an easily operated (i.e. an effort not exceeding 20 N·m) release key which is supplied by the manufacturer of the coupling device, are not permitted for use. Please note that the mechanical coupling device that is fitted and not in use must always be removed or repositioned if the rear number plate and/or rear lighting devices are obscured by any part of the mechanical coupling device.
- Kia trailer hitch accessory is available at an authorized Kia dealer/service partner.

Safety chains

You should always attach chains between your vehicle and your trailer. Cross the safety chains under the tongue of the trailer so that the tongue will not drop to the road if it becomes separated from the hitch.

Instructions about safety chains may be provided by the hitch manufacturer or by the trailer manufacturer. Follow the manufacturer's recommendation for attaching safety chains. Always leave just enough slack so you can turn with your trailer. Never allow safety chains to drag on the ground.

Trailer brakes

If your trailer is equipped with a braking system, make sure it conforms to the country's regulations, and that it is properly installed and it is operating correctly.

If your trailer weighs more than the maximum trailer weight without trailer brakes loaded, then it needs its own brakes, and those trailer brakes must be adequate. Be sure to read and follow the instructions for the trailer brakes so that you will be able to install, adjust, and maintain them properly.

- Do not tap into your vehicle's brake system.

WARNING

Do not use a trailer with its own brakes unless you are absolutely certain that you have properly set up the brake system. This is not a task for amateurs. Use an experienced, competent trailer shop for this work.

Driving with a trailer

Towing a trailer requires a certain amount of experience. Before setting out for the open road, you must get to know your trailer. Acquaint yourself with the feel of handling and braking with the added weight of the trailer. Always keep in mind that the vehicle you are driving is now a lot longer and not nearly as responsive as your vehicle is by itself. Before you start, check the trailer hitch and platform, safety chains, electrical connector(s), lights, tires, and mirror adjustment. If the trailer has electric brakes, start your vehicle and trailer moving, and then apply the trailer brake controller by hand to make sure the brakes are working. This lets you check your electrical connection at the same time.

During your trip, check occasionally to make sure that the load is secure and that the lights and trailer brakes are still working.

* NOTICE

When the ambient temperature is lower than 0°C (32°F) and the remaining high voltage battery is low, the power of the vehicle with a trailer can be dropped, causing a trouble in acceleration or drop of the speed when driving hills.

When driving with a trailer, be sure to charge the high voltage battery more than 50% if the ambient temperature is lower than 0°C (32°F).

Following distance

Stay at least twice as far behind the vehicle ahead as you would when driving your vehicle without a trailer. This

can help you avoid situations that require heavy braking and sudden turns.

Passing

You will need more passing distance ahead when towing a trailer. Likewise, due to the increased vehicle length, you will need to go much farther beyond the passed vehicle before you can return to your lane.

Reversing

Hold the bottom of the steering wheel with one hand. Then, to move the trailer to the left, just move your hand to the left. To move the trailer to the right, move your hand to the right. Always reverse slowly and have someone guide you, if possible.

Making turns

When turning with a trailer, make wider turns than normal. This is to make sure that your trailer does not hit soft shoulders, curbs, road signs, trees, or other objects. Avoid jerky or sudden maneuvers. Signal well in advance.

Turn signals when towing a trailer

When you tow a trailer, your vehicle has to have a different turn signal flasher and extra wiring. The green arrows on your instrument cluster will flash whenever you signal a turn or lane change. If properly connected, the trailer lights will also flash to alert other drivers to the fact that you are about to turn, change lanes, or stop.

When towing a trailer, the green arrows on your instrument cluster will flash for turns even if the bulbs on the trailer are

burned out. Thus, you may think drivers behind you are seeing your signals when, in fact, they are not. It is important to check occasionally to make sure the trailer bulbs are still working. You must also check the lights every time you disconnect, and then reconnect the wires.

Do not connect a trailer lighting system directly to your vehicle's lighting system. Use only an approved trailer wiring harness.

Seek assistance from a professional workshop for the installation of the wiring harness.

Kia recommends visiting an authorized Kia dealer/service partner.

WARNING

Failure to use an approved trailer wiring harness could result in damage to the vehicle electrical system and/or personal injury.

Driving on grades

Reduce speed before you start down a long or steep downgrade.

On a long uphill grade, shift down and reduce your speed to around 70 km/h (45 mph) to reduce the possibility of motor overheating.

CAUTION

- To prevent motor overheating:
If you tow a trailer with the maximum gross vehicle weight and maximum trailer weight, it can cause the motor to overheat. When driving in such conditions, stop the vehicle until it cools down. You may proceed once the motor has cooled sufficiently.
When towing a trailer, your vehicle speed may be much slower than the

general flow of traffic, especially when climbing an uphill grade. Use the outer lane when towing a trailer on an uphill grade. Choose your vehicle speed according to the maximum posted speed limit for vehicles with trailers, the steepness of the grade, and your trailer weight.

- You must decide the driving speed depending on trailer weight and uphill grade to reduce the possibility of motor overheating.

WARNING

- Parking your vehicle on a hill with a trailer attached could cause serious injury or death, should the trailer break loose.
- It can be dangerous to get out of your vehicle if the parking brake is not firmly set. If you have left the vehicle running, the vehicle can move suddenly. You or others could be seriously or fatally injured.

Parking on hills

Generally, if you have a trailer attached to your vehicle, you should not park your vehicle on a hill. Both your vehicle and the trailer can be damaged if they unexpectedly roll down the hill, and people can be seriously or fatally injured.

If you ever need to park your trailer on a hill, however, here is how to do it:

1. Pull the vehicle into the parking space. Turn the steering wheel in the direction of the curb (right if headed downhill, left if headed up hill. For right-hand drive, left if headed down hill, right if headed up hill).
2. Engage the parking brake and shut off the vehicle.
3. Place chocks under the trailer wheels on the downhill side of the wheels.
4. Start the vehicle, hold the brakes, shift to neutral, release the parking brake, and slowly release the brakes until the trailer chocks absorb the load.
5. Reapply the brakes, reapply the parking brake.
6. Shut off the vehicle and release the vehicle brakes but leave the parking brake applied.

When you are ready to leave after parking on a hill

1. Apply your brakes and hold the brake pedal down while:
 - Start your vehicle;
 - Shift into gear; and
 - Release the parking brake.
2. Slowly remove your foot from the brake pedal.
3. Drive slowly until the trailer is clear of the chocks.
4. Stop and have someone pick up and store the chocks.

Maintenance when towing a trailer

Your vehicle will need to be serviced more often if you regularly pull a trailer. Important items to pay particular attention to include reduction gear fluid, axle lubricant and cooling system fluid. Brake condition is another important item to check frequently. Each item is covered in this manual, and the Index will help you find them quickly. If you are towing a trailer, it is a good idea to review these sections before starting your trip.

Do not forget to maintain your trailer and hitch as well. Make sure you are

aware of the maintenance schedule specified for your trailer, and that you carry out its periodic checks. Preferably, conduct your checks at the start of each day's driving. Most importantly, all hitch nuts and bolts should be tight.

⚠ CAUTION

- Due to higher load during trailer usage, overheating might occur in hot days or during uphill driving.
- When towing, check the reduction gear fluid more frequently.

If you do decide to tow a trailer

Here are some important points if you decide to tow a trailer:

- Consider using a sway control. You can ask a hitch dealer about sway control.
- Do not do any towing with your vehicle during its first 2,000 km (1,200 miles) in order to allow the motor to properly break in. Failure to heed this caution may result in serious motor damage.
- When towing a trailer, Kia recommends that you consult an authorized Kia dealer/service partner on additional requirements such as a towing kit, etc.
- Always drive your vehicle at moderate speed of less than 100 km/h (60 mph).
- The driving range of Electric Vehicle could be affected by the shape and weight of the trailer. Depending on the trailer, the driving range could decrease by 50%.
- On a long uphill grade, do not exceed 70 km/h (45 mph) or the posted towing speed limit, whichever is lower.

- The chart contains important considerations that have to do with weight:

For Europe

Item		Weight (Standard type)	Weight (Extended type)
Maximum trailer weight	With brake system	750 kg (1,653 lbs.)	1,600 kg (3,527 lbs.)
	Without brake system	750 kg (1,653 lbs.)	
Maximum permissible static vertical load on the coupling device		100 kg (220 lbs.)	
Recommended distance from rear wheel center to coupling point		1,025 mm (40.4 inch)	

For Australia and New Zealand

Item		Weight (Standard type)	Weight (Extended type)
Maximum trailer weight	With brake system	750 kg (1,653 lbs.)	1,600 kg (3,527 lbs.)
	Without brake system	750 kg (1,653 lbs.)	
Maximum permissible static vertical load on the coupling device		100 kg (220 lbs.)	
Recommended distance from rear wheel center to coupling point		1,025 mm (40.4 inch)	

Weight of the trailer

What is the maximum safe weight of a trailer? It should never weigh more than the maximum trailer weight with trailer brakes. But even that can be too heavy. It depends on how you plan to use your trailer. For example, speed, altitude, road grades, and outside temperature as well as how often your vehicle is used to tow a trailer are all important. The ideal trailer weight can also depend on any special equipment that you have on your vehicle.

Weight of the trailer tongue

The tongue load of any trailer is an important weight to measure because it affects the total gross vehicle weight (GVW) of your vehicle. This weight includes the curb weight of the vehicle, any cargo you may carry in it, and the people who will be riding in the vehicle. And if you tow a trailer, you must add the tongue load to the GVW because your vehicle will also be carrying that weight.

The trailer tongue should weigh a maximum of 10% of the total loaded trailer weight, within the limits of the maximum trailer tongue load permissible.

After you have loaded your trailer, weigh the trailer and then the tongue separately to see if the weights are acceptable. If they are not, you may be able to correct them simply by moving some items around in the trailer.

WARNING

- Never load a trailer with more weight in the rear than in the front. The front should be loaded with approximately 60% of the total trailer load; the rear should be loaded with approximately 40% of the total trailer load.
- Never exceed the maximum weight limits of the trailer or trailer towing equipment. Improper loading can result in damage to your vehicle and/or personal injury. Check weights and loading at a commercial scale or highway patrol office equipped with scales.
- An improperly loaded trailer can cause loss of vehicle control.

Vehicle weight

This section will give you guidance on the proper loading of your vehicle to keep your loaded vehicle weight within its design rating capability. Properly loading your vehicle will help you use the vehicle's design performance to maximum advantage. Before loading your vehicle, familiarize yourself with the following terms for determining your vehicle's weight ratings, which are used in the vehicle's specifications and on the certification label:

Base curb weight

This is the weight of the vehicle including all standard equipment. It does not include passengers, cargo, or optional equipment.

Vehicle curb weight

This is the weight of the vehicle including high voltage battery and all standard equipment. It does not include passengers, cargo, or optional equipment.

Cargo weight

This figure includes all weight added to the Base Curb Weight, including cargo and optional equipment.

GAW (Gross axle weight)

This is the total weight placed on each axle (front and rear) - including vehicle curb weight and all payload.

GAWR (Gross axle weight rating)

This is the maximum allowable weight that can be carried by a single axle (front or rear). These numbers are shown on the certification label.

The total load on each axle must never exceed its GAWR.

GVW (Gross vehicle weight)

This is the base curb weight plus the actual cargo weight plus passengers.

GVWR (Gross vehicle weight rating)

This is the maximum allowable weight of the fully loaded vehicle (including all options, equipment, passengers, and cargo). The GVWR is shown on the certification label located on the driver's (or front passenger's) door sill.

Overloading

WARNING

Vehicle weight

The gross axle weight rating (GAWR) and the gross vehicle weight rating (GVWR) for your vehicle are on the Certification Label attached to the driver's (or front passenger's) door. Exceeding these ratings can cause an accident or vehicle damage. You can calculate the weight of your load by weighing the items (and people) before putting them in the vehicle. Be careful not to overload your vehicle.

Loading Your Vehicle - For Australia (if equipped)

Certification Label



Tire Label



The Certification/Tire label is found on the front edge of the RH (or LH) "B" pillar. The label shows the size of your original tires and inflation pressures needed to obtain the gross weight capacity of your vehicle.

This is called the GVWR (Gross Vehicle Weight Rating). The GVWR includes the weight of the vehicle, all occupants and cargo. The Certification/Tire label also tells you the maximum weights for the front and rear axles, called Gross Axle Weight Rating (GAWR).

Never exceed the GVWR for your vehicle, or the Gross Axle Weight Rating (GAWR) for either the front or rear axle. And, if you do have a heavy load, you should spread it out.

Your warranty does not cover parts or components that fail because of overloading.

Do not load your vehicle any heavier than the GVWR or the maximum front and rear GAWRs. If you do, change to the vehicle may occur, or it can change the way your vehicle handles. These could cause you to lose control. Also, overloading can shorten the life of your vehicle.

What to do in an emergency

Road warning	7-2
• Hazard warning flasher.....	7-2
In the event of an emergency while driving	7-2
• If the vehicle stalls while driving.....	7-2
• If the vehicle stalls at a crossroad or crossing.....	7-2
• If you have a flat tire while driving.....	7-2
If the vehicle will not start	7-3
Emergency starting	7-3
• Jump-starting (12V battery).....	7-3
• Push-starting.....	7-4
Tire Pressure Monitoring System (TPMS)	7-5
• Checking the tire pressure.....	7-5
• When the telltale lights up.....	7-6
• Tire Pressure Monitoring System (TPMS) malfunction indicator.....	7-7
If you have a flat tire (with Tire Mobility Kit)	7-9
• Components of the Tire Mobility Kit.....	7-10
• Using the Tire Mobility Kit.....	7-11
• Distributing the sealant.....	7-11
• Checking tire inflation pressure.....	7-12
• Safe use of the Tire Mobility Kit.....	7-13
Towing	7-14
• Towing service.....	7-14
• Emergency towing.....	7-14
Emergency commodity	7-16
Pan-European eCall system	7-17
• Description of the eCall in-vehicle system.....	7-17
• Information on data processing.....	7-18
• Pan-European eCall System.....	7-19

What to do in an emergency

Road warning

Hazard warning flasher



Condition(s)

- When an emergency situation occurs while driving
- Parking by the edge of the roadway

Operation

- Push the hazard warning flasher switch.

In the event of an emergency while driving

If the vehicle stalls while driving

Operation

1. Reduce your speed and keep straight.
2. Stop the vehicle in a safe place.
3. Turn the hazard warning flasher on.
4. Restart the vehicle.

If the vehicle still does not start, contact a professional workshop or seek other qualified assistance. Kia recommends to call an authorized Kia dealer/service partner.

If the vehicle stalls at a crossroad or crossing

Operation

1. Shift to N (Neutral).
2. Push the vehicle to a safe place.

If you have a flat tire while driving

Operation

1. Reduce your speed slowly and keep straight.
2. Stop the vehicle in a safe, level place away from traffic.
3. Turn the hazard warning flasher on.
4. Set the parking brake.
5. Shift to P (Park).
6. Have all passengers get out of the vehicle and move away from traffic.

Refer to "If you have a flat tire (with Tire Mobility Kit)" on page 7-9.

If the vehicle will not start

Confirm the EV battery is not low on the charge gauge.

- Be sure P (Park) gear position is selected. The vehicle starts only when P (Park) gear position is selected.
- Check the 12-volt battery connections to be sure they are clean and tight.
- Turn on the interior light. If the light dims or goes out when you operate the starter, the 12V battery is drained.

Do not push or pull the vehicle to start it. This could cause damage to your vehicle.

Emergency starting

Jump-starting (12V battery)

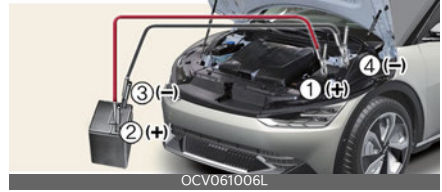

Condition(s)

- When the vehicle will not start due to low battery power

Operation

1. Connect the jumper cables as shown.
 - Positive (+) terminal of the flat battery (1) and the booster battery (2).
 - Negative (-) terminal of the flat battery (3) and the grounding point (4).
2. Start the vehicle with the booster battery for several minutes.
3. Try to start the vehicle with the flat battery again.
4. If the vehicle starts, disconnect the jumper cables as following:
 - Negative (-) terminal of the booster battery (3).
 - Positive (+) terminal of the booster battery (2)
 - Flat battery (1).

If the vehicle still does not start, contact a professional workshop or seek other qualified assistance. Kia recommends to call an authorized Kia dealer/service partner.

⚠ WARNING

- Keep all flames or sparks away from the battery. The battery produces hydrogen gas which may explode if exposed to flame or sparks. If these instructions are not followed exactly, serious personal injury and damage to the vehicle may occur! If you are not sure how to follow this procedure, seek qualified assistance. Automobile batteries contain sulfuric acid. This is poisonous and highly corrosive. When jump starting, wear protective glasses and be careful not to get acid on yourself, your clothing or on the vehicle.
- Do not attempt to jump start the vehicle if the discharged battery is frozen or if the electrolyte level is low; the battery may rupture or explode.
- Do not allow the (+) and (-) jumper cables to touch. It may cause sparks.
- Never attempt to check the electrolyte level of the battery as this may cause the battery to rupture or explode causing serious injury.
- The battery may rupture or explode when you jump start with a low or frozen battery.
- The electrical starting system works with high voltage. NEVER touch these components with the **READY** indicator ON or when the EV button is in the ON position.

⚠ CAUTION

Use only a 12-volt jumper system. You can damage other electrical parts beyond repair by use of a 24- volt power supply (either two 12-volt batteries in series or a 24-volt motor generator set).

*** NOTICE**

Do not connect the jumper cable from the negative terminal of the booster battery to the negative terminal of the discharged battery. This can cause the discharged battery to overheat and crack, releasing battery acid. Make sure to connect one end of the jumper cable to the negative terminal of the booster battery, and the other end to a metallic point, far away from the battery.

Push-starting

Your vehicle equipped with reduction gear should not be push-started.

⚠ WARNING

Never tow a vehicle to start it. When the vehicle starts, the vehicle can suddenly surge forward and could cause a collision with the tow vehicle.

Tire Pressure Monitoring System (TPMS)

Checking the tire pressure



- 1 Low tire pressure telltale/Tire Pressure Monitoring System (TPMS) malfunction indicator
- 2 Low tire pressure position telltale

Operation

1. Press the cluster menu button (☰) on the steering wheel.
2. Select 'Information mode' from the LCD display modes.

* INFORMATION

- You can change the tire pressure unit in the user settings mode on the cluster.
 - psi, kpa, bar (Refer to "LCD display modes" on page 5-47.)
- Each tire should be checked monthly when cold and inflated to the inflation pressure recommended by the vehicle manufacturer on the vehicle placard or tire inflation pressure label. (If your vehicle has tires of a different size than the size indicated on the vehicle placard or tire inflation pressure label, you should determine the

proper tire inflation pressure for those tires.)

As an added safety feature, your vehicle has been equipped with a tire pressure monitoring system (TPMS) that illuminates a low tire pressure telltale when one or more of your tires is significantly under-inflated. Accordingly, when the low tire pressure telltale illuminates, you should stop and check your tires as soon as possible, and inflate them to the proper pressure. Driving on a significantly under-inflated tire causes the tire to over-heat and can lead to tire failure.

Under-inflation also reduces electric energy efficiency and tire tread life, and may affect the vehicle's handling and stopping ability.

Note that the TPMS is not a substitute for proper tire maintenance, and it is the driver's responsibility to maintain correct tire pressure, even if under-inflation has not reached the level to trigger illumination of the TPMS low tire pressure telltale.

Your vehicle has also been equipped with a TPMS malfunction indicator to indicate when the system is not operating properly. The TPMS malfunction indicator is combined with the low tire pressure telltale. When the system detects a malfunction, the telltale will flash for approximately 1 minute and then remain continuously illuminated. This sequence will continue upon subsequent vehicle start-ups as long as the malfunction exists. When the TPMS malfunction indicator remains illuminated after blinking for approximately 1 minute, the system may not be able to detect or signal low tire pressure as intended.

TPMS malfunctions may occur for a variety of reasons, including the installation of replacement or alternate tires or wheels on the vehicle that prevent the TPMS from functioning properly. Always check the TPMS malfunction telltale after replacing one or more tires or wheels on your vehicle to ensure that the replacement or alternate tires and wheels allow the TPMS to continue to function properly.

⚠ WARNING

Significantly low tire pressure makes the vehicle unstable and can contribute to loss of vehicle control and increased braking distances.

Continued driving on low pressure tires can cause the tires to overheat and fail.

⚠ CAUTION

- In winter or cold weather, the low tire pressure telltale may illuminate if the tire pressure was adjusted to the recommended tire inflation pressure in warm weather. It does not mean your TPMS is malfunctioning because the decreased temperature leads to a lowering of tire pressure.
- When you drive your vehicle from a warm area to a cold area or from a cold area to a warm area, or the outside temperature is higher or lower, you should check the tire inflation pressure and adjust the tires to the recommended tire inflation pressure.
- When filling tires with more air, conditions to turn off the low tire pressure telltale may not be met. This is because a tire inflator has a margin of error in performance. The low tire pressure telltale will be turned off if

the tire pressure is above the recommended tire inflation pressure.

*** NOTICE**

If any of the below happens, have the system checked by a professional workshop. Kia recommends visiting an authorized Kia dealer/service partner.

1. The low tire pressure telltale/TPMS malfunction indicator do not illuminate for 3 seconds when the vehicle is in ON position or vehicle is running.
2. The TPMS malfunction indicator remains illuminated after blinking for approximately 1 minute.
3. The Low tire pressure position telltale remains illuminated.

When the telltale lights up



A: **Low tire pressure**

Condition(s)

- One or more of the tires is significantly under-inflated.

Operation

- The corresponding position light will light up to indicate which tire is significantly under-inflated.
- Reduce your speed, avoid hard cornering, and anticipate increased stopping distances.
- Stop and check the tires as soon as possible.

- Inflate the tires to the specified pressure.
- Replace the underinflated tire with a spare tire if this is not possible.

Tire Pressure Monitoring System (TPMS) malfunction indicator ⚠

Conditions

- Blinks for approximately 1 minute
 - When there is a problem with the Tire Pressure Monitoring System.

Contact a professional workshop or seek other qualified assistance. Kia recommends to call an authorized Kia dealer/service partner.

⚠ CAUTION

- The TPMS malfunction indicator may blink for approximately 1 minute and then remain continuously illuminated if the vehicle is moving around electric power supply cables or radios transmitter such as at police stations, government and public offices, broadcasting stations, military installations, airports, or transmitting towers, etc. This can interfere with normal operation of the Tire Pressure Monitoring System (TPMS).
- The TPMS malfunction indicator may blink for approximately 1 minute and then remain continuously illuminated if snow chains are used or some separate electronic devices such as notebook computer, mobile charger, remote starter or navigation etc., are used in the vehicle.

This can interfere with normal operation of the Tire Pressure Monitoring System (TPMS).

*** NOTICE**

If there is a malfunction with the TPMS, the low tire pressure position telltale will not be displayed even though the vehicle has an underinflated tire.

Changing a tire equipped with Tire Pressure Monitoring System (TPMS)

Contact a professional workshop or seek other qualified assistance. Kia recommends to call an authorized Kia dealer/service partner.

*** INFORMATION**

You may not be able to identify a low tire by simply looking at it. Always use a good quality tire pressure gauge to measure the tire's inflation pressure. Note that a tire that is hot (from being driven) will have a higher pressure measurement than a tire that is cold (from sitting stationary for at least 3 hours and driven less than 1 mile (1.6 km) during that 3 hour period).

Allow the tire to cool before measuring the inflation pressure. Always be sure the tire is cold before inflating to the recommended pressure.

A cold tire means the vehicle has been sitting for 3 hours and driven for less than 1 mile (1.6 km) in that 3 hour period.

⚠ WARNING

- The TPMS cannot alert you to severe and sudden tire damage caused by external factors such as nails or road debris.
 - If you feel any vehicle instability, immediately take your foot off the accelerator, apply the brakes gradually and with light force, and slowly move to a safe position off the road.
 - Tampering with, modifying, or disabling the Tire Pressure Monitoring System (TPMS) components may interfere with the system's ability to warn the driver of low tire pressure conditions and/or TPMS malfunctions. Tampering with, modifying, or disabling the Tire Pressure Monitoring System (TPMS) components may void the warranty for that portion of the vehicle.
-

⚠ WARNING

For Europe

- Do not modify the vehicle, it may interfere with the TPMS function.
- The wheels on the market do not have a TPMS sensor. For your safety, use parts for replacement from a professional workshop. Kia recommends visiting an authorized Kia dealer/service partner.
- If you use the wheels on the market, use a TPMS sensor approved by an authorized Kia dealer.

If your vehicle is not equipped with a TPMS sensor or TPMS does not work properly, you may fail the periodic vehicle inspection conducted in your country.

- All vehicles sold in the EUROPE market during below period must be equipped with TPMS.
 - New model vehicle: Nov. 1, 2012 ~
 - Current model vehicle: Nov. 1, 2014~ (Based on vehicle registrations)
-

⚠ CAUTION

We recommend that you use the sealant approved by Kia if your vehicle is equipped with a Tire Pressure Monitoring System. The liquid sealant can damage the tire pressure sensors.

If you have a flat tire (with Tire Mobility Kit)



- 1 Compressor
- 2 Sealant bottle

The Tire Mobility Kit is not designed or intended as a permanent tire repair method and is to be used for one tire only.

The system with compressor and sealing compound seals most tire punctures caused by nails or similar objects and reinflates the tire. However, larger punctures or sidewall damage cannot be sealed completely.

After ensuring that the tire is properly sealed, you can drive cautiously on the tire (for a distance of up to 200 km (120 miles)) at maximum speed of 80 km/h (50 mph) in order to reach a service station or a tire dealer to have the tire replaced.

Avoid abrupt steering or other driving maneuvers if the vehicle is heavily loaded or if a trailer is in use.

Refer to "Safe use of the Tire Mobility Kit" on page 7-13.

⚠ WARNING

- Do not use the Tire Mobility Kit to repair punctures in the tire walls. This can result in an accident due to tire failure.
- Have your tire repaired as soon as possible. The tire may lose air pressure at any time after inflating with the Tire Mobility Kit.
- Do not use the TMK if a tire is severely damaged by driving run flat or with insufficient air pressure. Only punctured areas located within the tread region of the tire can be sealed using the TMK.
- Do not use the Tire sealant after the sealant has expired (i.e. past the expiration date on the sealant container). This can increase the risk of tire failure.
- Keep the sealant out of reach of children, avoid sealant contact with eyes and do not swallow the sealant.

⚠ CAUTION

When two or more tires are flat, do not use the tire mobility kit because the supported one sealant of Tire Mobility Kit is only used for one flat tire.

* NOTICE



For 20 inch wheel, take out the remover tool in the Tire Mobility Kit. Insert the tool to the hole and pull out the wheel cover.

Components of the Tire Mobility Kit

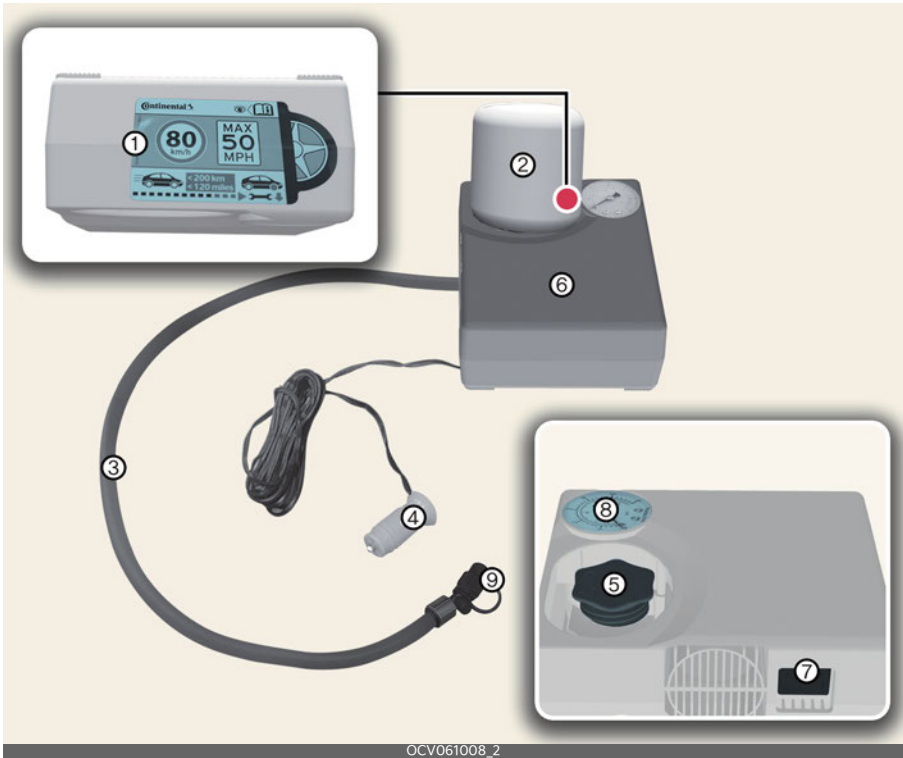

* Connectors, cable and connection hose are stored in the compressor housing.

* Strictly follow the specified sequence, otherwise the sealant may escape under high pressure.

- 1 Speed restriction label
- 2 Sealant bottle
- 3 Sealant bottle filling hose
- 4 Power outlet connector
- 5 Sealant bottle holder
- 6 Compressor
- 7 ON/OFF switch
- 8 Tire inflation pressure gauge
- 9 Tire inflation pressure valve

Using the Tire Mobility Kit

Operation

1. Shake the sealant bottle.



2. Remove the sealant bottle cap and sealant bottle holder cap and screw the bottle onto the sealant bottle holder.



3. Make sure the compressor valve on the filling hose is locked.



4. Unscrew the valve cap and screw the filling hose onto the tire valve.



5. Make sure the compressor is turned off.
6. Connect the power outlet connector.



7. Start the vehicle.
8. Turn the compressor on and let it run for approximately 5~7 minutes to fill the sealant up to the proper pressure.
9. Turn the compressor off.
10. Detach the filling hose from the tire valve.

Distributing the sealant



Operation

- Immediately drive approximately 7~10 km (4~6 miles, or approximately 10 minutes) to distribute the tire sealant evenly.

⚠ WARNING

- Do not leave your vehicle running in a poorly ventilated area for extended periods of time. Carbon monoxide poisoning and suffocation can occur.
- If the tire pressure is below 26 psi (180 kPa), do not drive the vehicle. The tire may cause accident.

⚠ CAUTION

- Securely install the sealant filling hose to the valve. If not, sealant may flow backward, possibly clogging the filling hose.
- Do not exceed a speed of 80 km/h (50 mph). If possible, do not fall below a speed of 20 km/h (12 mph). While driving, if you experience any unusual vibration, ride disturbance or noise, reduce your speed and drive with caution until you can safely pull off of the side of the road. Call for road side service or towing. When you use the Tire Mobility Kit, the wheel may be stained by sealant. Therefore, remove the wheel stained by sealant and have the vehicle inspected at a professional workshop. Kia recommends visiting an authorized Kia dealer/service partner.

Checking tire inflation pressure

Operation

1. After driving approximately 7~10 km (4~6 miles, or approximately 10 minutes), stop the vehicle in a safe, level place.
2. Connect the filling hose directly to the tire valve.



3. Connect the power outlet connector.
4. Adjust the tire inflation pressure to the specified value.

- Turn the compressor on to increase the inflation pressure. Turn the compressor off briefly to check the current inflation pressure.
- Turn the compressor valve to reduce the inflation pressure.

⚠ WARNING

- Do not let the compressor run for more than 10 minutes, otherwise the device will overheat and may be damaged.
- The tire inflation pressure must be inflated to the proper pressure (Refer to "Tires and wheels" on page 9-4). If it is not, do not continue driving. Call for road side service or towing.

⚠ CAUTION

- If the inflation pressure is not maintained, drive the vehicle a second time, refer to "Distributing the sealant" on page 7-11. Then repeat steps 1 to 4.
- Use of the TMK may be ineffectual for tire damage larger than approximately 4 mm (0.16 inches).
- We recommend that you contact a professional workshop if the tire cannot be made roadworthy with the Tire Mobility Kit.

*** NOTICE**

When reinstalling the repaired or replaced tire and wheel on the vehicle, tighten the wheel lug nut to 11~13 kgf·m (79~94 lbf·ft).

Safe use of the Tire Mobility Kit

- Stop the vehicle in a safe, level place away from traffic.
- Set the parking brake.
- Only use the Tire Mobility Kit for sealing/inflating passenger vehicle tires.
- Do not remove any foreign objects from the tire.
- Read the precautionary advice printed on the sealant bottle before using the Tire Mobility Kit.
- Leave the vehicle running. Operating the Tire Mobility Kit may drain the battery.
- Never leave the Tire Mobility Kit unattended while it is being used.
- Do not leave the compressor running for more than approximately 10 minutes at a time or it may overheat.
- Do not use the Tire Mobility Kit if the ambient temperature is below -30 °C (-22 °F).
- Do not use the Tire Mobility Kit if the tire and wheel are damaged.

Technical Data

- System voltage: DC 12 V
- Working voltage: DC 12 V
- Amperage rating: max. 15 A
- Suitable temperatures: -30 to 70 °C (-22 to 158 °F)
- Max. working pressure: 7 bar (101 psi)
- Size
 - Compressor: 150 x 130 x 60 mm (5.9 x 5.1 x 2.4 inches)
 - Sealant bottle: 115.3 x 87.3 ø mm (4.5 x 3.4 ø inches)
 - Compressor weight: 620 g (1.36 lbs.)
 - Sealant volume: 400 ml (24.4 cu. in)

* Sealant and spare parts can be obtained and replaced at an authorized vehicle or tire dealer. Empty sealant bottles may be disposed of at home. Liquid residue from the sealant should be disposed of by your vehicle or tire dealer or in accordance with local waste disposal regulations.

Towing

Towing service

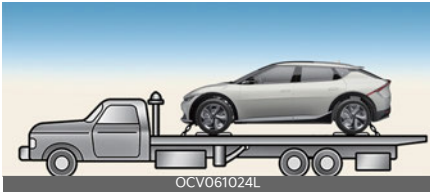

Operation

- Tow the vehicle with a flatbed equipment with all wheels off the ground.

* INFORMATION

If emergency towing is necessary, we recommend having it done by an authorized Kia dealer or a commercial tow-truck service.

⚠ CAUTION

- Do not tow the vehicle forwards with the rear wheels on the ground as this may cause damage to the vehicle.
- Do not tow with sling-type equipment. Use wheel lift or flatbed equipment.
- The 4WD vehicle should never be towed with the wheels on the ground. This can cause serious damage to the vehicle or the 4WD system.

Emergency towing

Front



Rear



Operation

1. Remove the hole cover by pressing the lower part of the cover on the bumper.
2. Install the towing hook by screwing it clockwise into the hole until it is fully secured.
3. After use, remove the towing hook and reinstall the cover.

* INFORMATION

Towing in this manner may be done only on hard-surfaced roads for a short distance and at low speed. Also, the wheels, axles, power train, steering and brakes must all be in good condition.

- Do not use the tow hooks to pull a vehicle out of mud, sand or other conditions from which the vehicle cannot be driven out under its own power.
- Avoid towing a vehicle heavier than the vehicle doing the towing.
- The drivers of both vehicles should communicate with each other frequently.

- Before emergency towing, check if the hook is not broken or damaged.
- Fasten the towing cable or chain securely to the hook.
- Do not jerk the hook. Apply it steadily and with even force.
- To avoid damaging the hook, do not pull from the side or at a vertical angle. Always pull straight ahead.
- Press the EV button to the ACC position so the steering wheel is not locked.
- Shift the gear to N (Neutral).
- Release the parking brake.
- To avoid serious damage to the gear, limit the vehicle speed to 15 km/h (10 mph) and drive less than 1.5 km (1 mile) when towing.
- Press the brake pedal with more force than normal since you will have reduced brake performance.
- More steering effort will be required because the power steering system will be disabled.
- If you are driving down a long hill, the brakes may overheat and brake performance will be reduced. Stop often and let the brakes cool off.

WARNING

Use extreme caution when towing the vehicle.

- Avoid sudden starts or erratic driving maneuvers which would place excessive stress on the emergency towing hook and towing cable or chain. The hook and towing cable or chain may break and cause serious injury or damage.
- If the disabled vehicle is unable to be moved, do not forcibly continue the towing. We recommend that you contact an authorized Kia dealer or a commercial tow truck service for assistance.
- Tow the vehicle as straight ahead as possible.
- Keep away from the vehicle during towing.

CAUTION

- Attach a towing strap to the tow hook.
- Using a portion of the vehicle other than the tow hooks for towing may damage the body of your vehicle.
- Use only a cable or chain specifically intended for use in towing vehicles. Securely fasten the cable or chain to the towing hook provided.
- Accelerate or decelerate the vehicle in a slow and gradual manner while maintaining tension on the tow rope or chain to start or drive the vehicle, otherwise tow hooks and the vehicle may be damaged.

Emergency commodity (if equipped)

Fire extinguisher

If there is small fire and you know how to use the fire extinguisher, follow these steps carefully.

1. Pull out the safety pin at the top of the extinguisher that keeps the handle from being accidentally pressed.
2. Aim the nozzle towards the base of the fire.
3. Stand approximately 2.5 m (8 ft) away from the fire and squeeze the handle to discharge the extinguisher. If you release the handle, the discharge will stop.
4. Sweep the nozzle back and forth at the base of the fire. After the fire appears to be out, watch carefully since it may re-ignite.

First-aid kit

Scissors, bandages, adhesive tape, etc. are provided in the kit.

Reflector triangle

Place the Reflector triangle on the road to warn oncoming vehicles.

Tire pressure gauge

1. Unscrew the inflation valve cap.
2. Press and hold the gauge against the tire valve.
3. Pressing firmly will activate the gauge and avoid too much leak.
4. Adjust the inflation of the tires to the specified pressure, as necessary.
5. Reinstall the inflation valve cap.

WARNING

- When an accident occur, park the vehicle to a safe place. To avoid the leak of electricity in high voltage battery, turn the vehicle off and pull the yellow label in the high voltage battery switch to shut down the high voltage battery. Also, disconnect the auxiliary battery(12V) cable to shut-down. Be sure to disconnect both (+) cable and (-) cable.
- Do not touch the exposed electric wires. Do not touch high voltage wires (orange), connectors and other electric components.
- When an accident occur, the lethal gas and fluid from damaged high voltage battery can be leaked. Be aware not to touch or exposed to the gas and fluid. When flammable or poison gas leak inside the vehicle, open windows and evacuate to a safe place. When leaked fluid comes in contact with your eyes, flush your eyes with clean water. When the fluid contacts with your skin, wash it with salt water. Get immediate medical attention afterward.
- When the vehicle is flooded, immediately turn the vehicle off and evacuate to a safe place. For your safety we recommend to call the fire station and or visit an authorized Kia dealer/service partner.
- When the fire spread to the high voltage battery, the additional fire may occur. In this situation, be sure to accompany a fire truck when the vehicle is being towed.

Pan-European eCall system (if equipped)

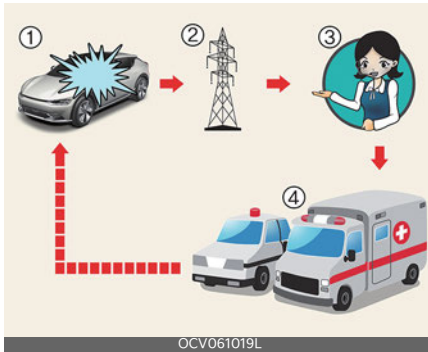

- 1 Road accident
- 2 Wireless network
- 3 Public Safety Answering Point (PSAP)
- 4 Rescue

The car is equipped with a device¹ connected with the Pan-European eCall system for making emergency call to response teams. The Pan-European eCall system is an automatic emergency call service made in event of a traffic accident or other² accidents on the roads of Europe. (only in countries with regulation on this system)

The system allows contacting an officer of a single-duty dispatch service in the event of an accident on the roads of Europe (only in countries with regulations for this system).

* 1. As described in the Owner's Manual, there is a Pan-European eCall device installed in the car that is responsible for providing the connection with the Pan-European eCall system.

* 2. "Other accidents" mean any accidents on the roads of Europe (only in countries with regulation on this system) resulted in injured people and/or necessity of provision of assistance. In

the event of an accident, it is necessary to stop the vehicle and press the SOS button. When making a call, the system gathers information about the car from which the call is being made, after which it connects the car with an officer of the Public Safety Answering Point (PSAP) to enable reporting of the reason for the emergency call.

Description of the eCall in-vehicle system

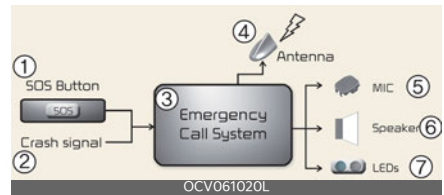

- 1 SOS Button
- 2 Crash signal
- 3 Emergency Call System
- 4 Antenna
- 5 MIC
- 6 Speaker
- 7 LEDs

Overview of the 112-based eCall in-vehicle system, its operation, and its functionality: refer to this section. The 112-based eCall service is a generally available public service and is accessible free of charge.

The 112-based eCall in-vehicle system is activated by default. It is activated automatically by means of in-vehicle sensors in the event of a severe accident.

It will also be triggered automatically if the vehicle is equipped with a TPS system that does not function in the event of a severe accident.

The 112-based eCall in-vehicle system can also be triggered manually, if neces-

sary. Instructions for manual activation of the system: refer to this section.

In the event of a critical system failure that would disable the 112-based eCall in-vehicle system, the following warning will be given to the occupants of the vehicle: refer to this section.

Information on data processing

Any processing of personal data through the 112-based eCall in-vehicle system shall comply with the personal data protection rules provided for in Directives 95/46/EC (1) and 2002/58/EC (2) of the European Parliament and of the Council, and in particular, shall be based on the necessity to protect the vital interests of the individuals in accordance with Article 7(d) of Directive 95/46/EC (3).

Processing of such data is strictly limited to the purpose of handling the emergency eCall to the single European emergency number 112.

Types of data and its recipients

The 112-based eCall in-vehicle system may collect and process only the following data:

- Vehicle Identification Number
- Vehicle type (passenger vehicle or light commercial vehicle)
- Vehicle propulsion storage type (gasoline/diesel/CNG/LPG/electric/hydrogen)
- Vehicle's recent locations and direction of travel
- Log file of the automatic activation of the system and its timestamp
- Any additional data (if applicable): Not applicable

Recipients of data processed by the 112-based eCall in-vehicle system are the relevant public safety answering points

designated by the respective public authorities of the country on which territory they are located, to first receive and handle eCalls to the single European emergency number 112. Additional information (if available): Not applicable

1. Directive 95/46/EC of the European Parliament and of the Council of 24 October 1995 on the protection of individuals with regard to the processing of personal data and on the free movement of such data (OJ L 281, 23.11.1995, p. 31).
2. Directive 2002/58/EC of the European Parliament and of the Council of 12 July 2002 concerning the processing of personal data and the protection of privacy in the electronic communications sector (Directive on privacy and electronic communications) (OJ L 201, 31.7.2002, p. 37).
3. Directive 95/46/EC is repealed by Regulation (EU) 2016/679 of the European Parliament and of the Council of 27 April 2016 on the protection of natural persons with regard to the processing of personal data and on the free movement of such data (General Data Protection Regulation) (OJ L 119, 4.5.2016, p. 1). The Regulation applies from 25 May 2018.

Arrangements for data processing

The 112-based eCall in-vehicle system is designed in such a way as to ensure that the data contained in the system memory is not available outside the system before an eCall is triggered. Additional remarks (if any): Not applicable

The 112-based eCall in-vehicle system is designed in such a way as to ensure that it is not traceable and not subject to any constant tracking in its normal operating

status. Additional remarks (if any): Not applicable

The 112-based eCall in-vehicle system is designed in such a way as to ensure that data in the system's internal memory is automatically and continuously removed.

The vehicle location data is constantly overwritten in the internal memory of the system so that a maximum of only the three most recent locations of the vehicle are kept for the normal functioning of the system.

The log of activity data in the 112- based eCall in-vehicle system is kept for no longer than is necessary to achieve the goal of handling the emergency eCall, and never beyond 13 hours from the moment an emergency eCall is initiated. Additional remarks (if any): Not applicable

Modalities for exercising the data subject's rights

The data subject (the vehicle's owner) has the right to access data and, as appropriate, request the rectification, erasure, or blocking of data concerning him or her whose processing does not comply with the provisions of Directive 95/46/EC. Any third parties to whom the data have been disclosed have to be notified of such rectification, erasure or blocking carried out in compliance with this Directive, unless it proves impossible or involves a disproportionate effort.

The data subject has a right to complain to the competent data protection authority if he or she considers that his or her rights have been infringed as a result of the processing of his or her personal data.

Contact service responsible for handling access requests (if any): Not applicable

Pan-European eCall System



- 1 Microphone
- 2 SOS button
- 3 LED

SOS button: The driver/passenger makes an emergency call to the single-duty dispatch service by pressing the button.

LED: The red and green LED illuminates for 3 seconds when the vehicle is set to ON. Other than that, they will be switched off during normal operation of the vehicle.

If there are problems in the system, the LED remains illuminated red.

Automatic accident reporting

1. System operation in the event of a traffic accident



2. Connection with the Public Safety Answering Point (PSAP)



OCV061027L

3. Emergency services



OCV061028L

The Pan-European eCall device automatically makes an emergency call to the Public Safety Answering Point (PSAP) to request appropriate rescue operations in the event of a car accident. For the purpose of providing appropriate emergency services response and support, the Pan-European eCall system automatically transmits the accident data to the Public Safety Answering Point (PSAP) when a traffic accident is detected.

In this situation, the emergency call cannot be hung up by pressing the SOS button; the Pan-European eCall system remains connected until the emergency service officer receiving the call disconnects the emergency call.

In minor traffic accidents, the Pan-European eCall system may not execute an emergency call. However, an emergency call may be made manually by pressing the SOS button.

CAUTION

Operation of the system is impossible in case of absence of mobile transmission and GPS and Galileo signals.

Manual accident reporting

1



OCV061026L

2



OCV061027L

3



OCV061028L

The driver or passenger can manually make an emergency call to the Public Safety Answering Point (PSAP) by pressing the SOS button, which will connect him/her with the necessary emergency services.

A call to the emergency services through the Pan-European eCall system can be canceled by pressing the SOS button again only before the call is connected.

After activation of an emergency call in manual mode (to obtain appropriate emergency services and support), the Pan-European eCall system automatically transmits data about the road accident or other type of accident to the officer of the Public Safety Answering Point (PSAP). This occurs during the emergency call initiated by pressing the SOS button.

If the driver or passenger accidentally presses the SOS button, the call can be canceled by pressing the button again within 3 seconds. It cannot be canceled after that.

In the event of a road accident or other accident, activation of an emergency call in manual mode requires the following:

1. Stop the car in accordance with traffic rules to ensure your safety and that of other participants of road traffic.
2. Press the SOS button, which initiates registration of the device via the cellular phone network and sends a minimal amount of data about the car and its location as collected in accordance with of the technical requirements of the service.

After that, direct contact is made with an officer of the Pan-European eCall system in order to establish the reasons for the emergency call and the related circumstances.

3. After establishing the reasons for the emergency call, the officer of the Public Safety Answering Point (PSAP) sends emergency services and completes the emergency call.

If the emergency call is not carried out in accordance with the procedure mentioned above, the call will be considered erroneous.

WARNING

- Emergency power supply of the Pan-European eCall system from the battery
 - The Pan-European eCall system battery supplies power during 1 hour in case main power source of the vehicle is cut off due to the collision during the emergency situations.
 - The Pan-European eCall system battery should be replaced every 4 years.
- **LED illumination in red (system malfunction)**

If red LED illuminates in normal driving conditions, this can indicate malfunction of the Pan-European eCall system. Please, have the Pan-European eCall system checked at an authorized Kia dealership immediately. Otherwise correct operation of the Pan-European eCall system device, installed in your car is not guaranteed. Owner of the car incurs liability for consequences, occurred as a result of nonobservance of conditions, mentioned above.

Arbitrary Removal or Modification

The Pan-European eCall system calls emergency services for assistance. Thus, any arbitrary removal or changes to the Pan-European eCall system settings may affect your driving safety. Also, it may even make an erroneous emergency call to the Public Safety Answering Point (PSAP). Thereby, we kindly ask you not to make any changes by yourself or by the third parties in the settings of the equipment of the Pan-European eCall system, installed in your car.

Motor room compartment	8-3
Maintenance services	8-4
• Owner's responsibility	8-4
• Owner maintenance precautions	8-4
Owner maintenance schedule	8-5
• When you stop for charging	8-5
Scheduled maintenance service	8-6
Coolant	8-9
Brake fluid	8-9
• Checking the brake fluid level.....	8-9
Washer fluid	8-10
• Checking the washer fluid level.....	8-10
Climate control air filter	8-11
• Replacing the climate control air filter	8-11
Wiper blade	8-12
• Replacing the front wiper blade	8-12
Battery	8-13
• For best battery service	8-13
• Battery capacity label.....	8-14
• Battery recharging.....	8-14
• Reset items	8-15
Tires and wheels	8-15
• Tire care	8-15
• Recommended cold tire inflation pressures	8-15
• Checking tire inflation pressure.....	8-15
• Tire rotation	8-17
• Wheel alignment and tire balance.....	8-17
• Tire replacement	8-17
• Wheel replacement	8-18

8 Maintenance

• Tire traction	8-18
• Tire maintenance	8-18
• Tire sidewall labeling.....	8-19
• Low aspect ratio tire	8-21
Fuses.....	8-22
• Replacing inner panel fuse.....	8-23
• Replacing motor room fuse.....	8-24
• Fuse/relay panel description	8-25
Lamps	8-33
• Bulb replacement precautions.....	8-33
• Light position (Front).....	8-34
• Light position (Rear)	8-35
• Light position (Side).....	8-35
• Replacing lights (LED type, except glove box lamp).....	8-35
• Replacing glove box lamp (Bulb type)	8-35
• Headlamp aiming (for Europe).....	8-36
Appearance care.....	8-40
• Exterior care	8-40
• Interior care	8-44

Maintenance

Motor room compartment

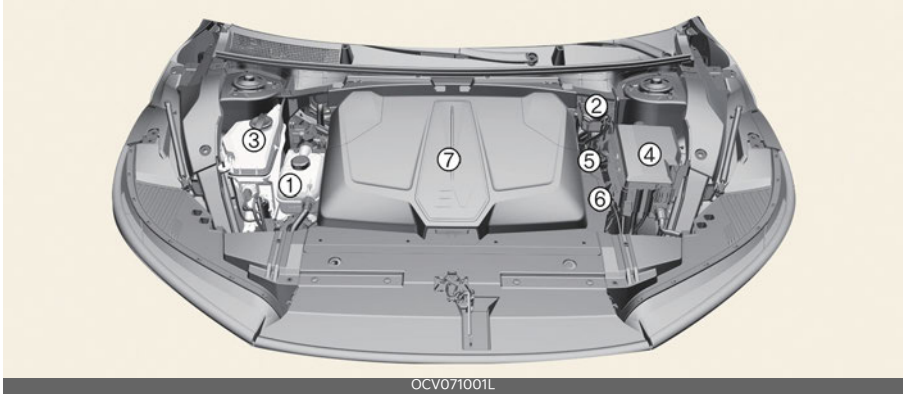

* The actual features in your vehicle may not necessarily be available due to the selected options or regions.

1 Coolant reservoir

2 Brake fluid reservoir

* This part is located on the opposite side for Right-hand drive vehicle.

3 Windshield washer fluid reservoir

4 Fuse box

5 Negative battery terminal (-)

6 Positive battery terminal (+)

7 Front trunk

Maintenance services

Owner's responsibility

- Have your vehicle serviced by a professional workshop. Kia recommends visiting an authorized Kia dealer/service partner.
- Retain documents that show proper maintenance.
- Establish your compliance with the servicing and maintenance requirements of your vehicle warranties.
- Repairs and adjustments required as a result of improper maintenance or lack of required maintenance are not covered even when your vehicle's warranty has not yet expired.

* NOTICE

Maintenance Service and Record Retention are the owner's responsibility.

Owner maintenance precautions

Improper or incomplete service may result in problems. This section gives instructions only for the maintenance items that are easy to perform.

⚠ WARNING

- Performing maintenance work on a vehicle can be dangerous. You can be seriously injured while performing some maintenance procedures. If you lack sufficient knowledge and experience or the proper tools and equipment to do the work, have the system serviced by a professional workshop. Kia recommends visiting an authorized Kia dealer/service partner.

- Working under the hood with the vehicle running is dangerous. It becomes even more dangerous when you wear jewelry or loose clothing. These can become entangled in moving parts and result in injury. Therefore, if you must run the vehicle while working under the hood, make certain that you remove all jewelry (especially rings, bracelets, watches, and necklaces) and all neckties, scarves, and similar loose clothing before getting near the vehicle or cooling fans.

⚠ CAUTION

- Before touching the battery and electrical wiring, you should disconnect the battery (-) terminal. You may get an electric shock from the electric current.
- When you remove the interior trim cover with a flat-blade screwdriver, be careful not to damage the cover.
- Be careful when you replace and clean bulbs to avoid burns or electrical shock.

* NOTICE

Improper owner maintenance during the warranty period may affect warranty coverage. For details, read the separate Warranty & Maintenance book provided with the vehicle. If you're unsure about any servicing or maintenance procedure, have the system serviced by a professional workshop. Kia recommends visiting an authorized Kia dealer/service partner.

Owner maintenance schedule

When you stop for charging

- Check the coolant level in the coolant reservoir.
- Check the windshield washer fluid level.
- Look for low or underinflated tires.

WARNING

Be careful when checking your coolant level when the motor compartment is hot. Scalding hot coolant and steam may blow out under pressure. This could cause burns or other serious injury.

While operating your vehicle

- Check for vibrations in the steering wheel. Notice any increased steering effort or looseness in the steering wheel, or change in its straight ahead position.
- Notice if your vehicle constantly turns slightly or "pulls" to one side when traveling on smooth, level road.
- When stopping, listen and check for unusual sounds, pulling to one side, increased brake pedal travel, and "hard-to-push" brake pedal.
- If any slipping or changes in the operation of your gear shift occurs, check the gear fluid level.
- Check the parking brake.
- Check for fluid leaks under your vehicle (water dripping from the air conditioning system during or after use is normal).

At least monthly

- Check the coolant level in the coolant reservoir.
- Check the operation of all exterior lights, including the stoplights, turn signals and hazard warning flashers.
- Check the inflation pressures of all tires including the spare and look for tires that are worn or which show uneven wear or damage.
- Check for loose wheel lug nuts.

At least twice a year

- Check the cooling system, heater, and air conditioning hoses for leaks or damage.
- Check the windshield washer spray and wiper operation. Clean the wiper blades with clean cloth dampened with washer fluid.
- Check the headlamp alignment.
- Check the lap/shoulder belts for wear and proper functioning.

At least once a year

- Clean the body and door drain holes.
- Lubricate the door hinges and hood hinges.
- Lubricate the locks and latches of the doors and hood.
- Lubricate the door rubber weatherstrips.
- Check the air conditioning system.
- Inspect and lubricate the shift gear linkage and controls.
- Clean the battery and terminals.
- Check the brake fluid level.

Scheduled maintenance service

Normal maintenance schedule - for Europe

I: Inspect and adjust, correct, clean, or replace if necessary.

R: Replace or change.

Number of months or driving distance, whichever comes first								
Months	24	48	72	96	120	144	168	192
Miles×1,000	20	40	60	80	100	120	140	160
Km×1,000	30	60	90	120	150	180	210	240
Coolant ^{*1,2}	At first, Replace 210,000 km (140,000 miles) or 120 months After that, Replace every 30,000 km (20,000 miles) or 24 months							
Reduction gear fluid	-	I	-	I	-	I	-	I
Drive shafts and boots	I	I	I	I	I	I	I	I
Cooling system ^{*3}	-	I	I	I	I	I	I	I
Air conditioner refrigerant/compressor (if equipped)	I	I	I	I	I	I	I	I
Climate control air filter	R	R	R	R	R	R	R	R
Brake discs and pads ^{*4}	I	I	I	I	I	I	I	I
Brake lines, hoses and connections	I	I	I	I	I	I	I	I
Brake fluid	R	R	R	R	R	R	R	R
Steering gear rack, linkage and boots	I	I	I	I	I	I	I	I
Suspension ball joints	I	I	I	I	I	I	I	I
Tire (pressure & tread wear)	I	I	I	I	I	I	I	I
12V Battery condition	I	I	I	I	I	I	I	I
Pan-European eCall system battery (if equipped)	Replace every 4 years							

* 1: When replacing or adding coolant, we recommend that you visit an authorized Kia dealer.

* 2: For your convenience, it can be replaced prior to its interval when you are doing other maintenance tasks.

* 3: We recommend that the coolant level and leak is checked on a daily basis.

* 4: **Brake discs and pads**

Check the pads for excessive wear, discs for run out and wear, and calipers for fluid leakage.

For more information on checking the pads or lining wear limit, we recommend to refer to the Kia web site.

(www.kia-hotline.com)

Normal maintenance schedule - except Europe

I: Inspect and adjust, correct, clean, or replace if necessary.

R: Replace or change.

Number of months or driving distance, whichever comes first								
Months	12	24	36	48	60	72	84	96
Miles×1,000	10	20	30	40	50	60	70	80
Km×1,000	15	30	45	60	75	90	105	120
Coolant ^{**2}	At first, Replace 210,000 km (140,000 miles) or 120 months After that, Replace every 30,000 km (20,000 miles) or 24 months							
Reduction gear oil	-	-	-	I	-	-	-	I
Drive shafts and boots	I	I	I	I	I	I	I	I
Cooling system ^{*3}	-	-	-	I	-	I	-	I
Air conditioner refrigerant/compressor (if equipped)	I	I	I	I	I	I	I	I
Climate control air filter	For Australia, New Zealand		I	R	I	R	I	R
	Except Australia, New Zealand		R	R	R	R	R	R
Brake discs and pads ^{*4}	-	I	-	I	-	I	-	I
Brake lines, hoses and connections	-	I	-	I	-	I	-	I
Brake fluid	I	R	I	R	I	R	I	R
Steering gear rack, linkage and boots	I	I	I	I	I	I	I	I
Suspension ball joints	I	I	I	I	I	I	I	I
Tire (pressure & tread wear)	I	I	I	I	I	I	I	I
12V Battery condition	I	I	I	I	I	I	I	I

* 1: When replacing or adding coolant, we recommend that you visit an authorized Kia dealer.

* 2: For your convenience, it can be replaced prior to its interval when you are doing other maintenance tasks.

* 3: We recommend that the coolant level and leak is checked on a daily basis.

* 4: Brake discs and pads

Check the pads for excessive wear, discs for run out and wear, and calipers for fluid leakage.

For more information on checking the pads or lining wear limit, we recommend to refer to the Kia web site.

(www.kia-hotline.com)

Maintenance under severe usage conditions

I: Inspect and adjust, correct, clean, or replace if necessary.

R: Replace or change.

Maintenance Item	Maintenance Operation	Maintenance Intervals	Driving Condition
Reduction gear fluid	R	Every 120,000 km (80,000 miles)	A, B, E, F, H, J
Drive shaft and boots	I	Inspect more frequently depending on the condition	B, C, D, E, F, G, H, I
Climate control air filter	R	Replace more frequently depending on the condition	B, D, F
Brake discs, pads and calipers	I	Inspect more frequently depending on the condition	B, C, D, F, G, H, I, J
Steering-gear rack, linkage, and boots	I	Inspect more frequently depending on the condition	C, D, E, F, G
Suspension ball joints	I	Inspect more frequently depending on the condition	B, C, D, E, F

Severe driving conditions

- A. Repeatedly driving short distance of less than 8 km (5 miles) in normal temperature or less than 16 km (10 miles) in freezing temperature
- B. Driving on rough, dusty, muddy, unpaved, graveled or salt spread roads
- C. Driving in areas using salt or other corrosive materials or in very cold weather
- D. Driving in heavy dust condition
- E. Driving in heavy traffic area with the ambient temperature higher than 32 °C (90 °F) while consuming more than 50% of electric energy.
- F. Driving on uphill, downhill, or mountain roads repeatedly
- G. Towing a trailer, or using a camper or roof rack
- H. Driving as a patrol car, taxi, other commercial use or vehicle towing
- I. Frequently driving under high speed or rapid acceleration/deceleration
- J. Frequently driving in stop-and-go conditions

Coolant



Check the condition and connections of all the cooling system hoses and heater hoses. Replace any swollen or deteriorated hoses.

The coolant level should be filled between the MAX or F and the MIN or L marks on the side of the coolant reservoir when the parts in the motor compartment is cool.

If the coolant is low, we recommend to visit an authorized Kia dealer/service partner.

⚠ WARNING



The electric motor for the cooling fan may continue to operate or start up when the

vehicle is not running and can cause serious injury.

Keep hands, clothing and tools away from the rotating fan blades of the cooling fan.

The electric motor for the cooling fan is controlled by vehicle coolant temperature, refrigerant pressure and vehicle speed. As the vehicle coolant temperature decreases, the electric motor will automatically shut off. This is a normal condition.

Brake fluid

Checking the brake fluid level



Operation

- Clean the area around the reservoir cap.
- Periodically check that the fluid level in the brake fluid reservoir is between MIN and MAX. The level will fall as the vehicle's mileage increases. This is a normal condition associated with the wear of the brake linings.

Use only the specified brake fluid. (Refer to "Recommended lubricants and capacities" on page 9-4.)

* INFORMATION

If the fluid level is excessively low, have the system checked by a professional workshop. Kia recommends visiting an authorized Kia dealer/service partner.

⚠ WARNING

- In the event the brake system requires frequent additions of fluid, have the system inspected by a professional workshop. Kia recommends visiting an authorized Kia dealer/service partner.

- When changing and adding brake fluid, handle it carefully. Do not let it come in contact with your eyes. If brake fluid should come in contact with your eyes, immediately flush them with a large quantity of fresh tap water. Have your eyes examined by a doctor as soon as possible.

⚠ CAUTION

Do not allow brake fluid to contact the vehicle's body paint, as paint damage will result. Brake fluid, which has been exposed to open air for an extended time should never be used as its quality cannot be guaranteed. It should be properly disposed. Don't put in the wrong kind of fluid. A few drops of mineral-based oil in your brake system can damage brake system parts.

Washer fluid

Checking the washer fluid level



Operation

- Check the fluid level in the washer fluid reservoir and add fluid if necessary. Plain water may be used if washer fluid is not available.
- However, use washer solvent with antifreeze characteristics in cold climates to prevent freezing.

The reservoir is translucent so that you can check the level with a quick visual inspection.

⚠ WARNING

- Do not use coolant or antifreeze in the washer fluid reservoir.
- Coolant can severely obscure visibility when sprayed on the windshield and may cause loss of vehicle control or damage to paint and body trim.
- Windshield Washer fluid agents contain some amounts of alcohol and can be flammable under certain circumstances. Do not allow sparks or flame to contact the washer fluid or the washer fluid reservoir. Damage to the vehicle or occupants could occur.
- Windshield washer fluid is poisonous to humans and animals. Do not drink and avoid contacting windshield washer fluid. Serious injury or death could occur.

Climate control air filter

Replacing the climate control air filter

Operation

1. Open the hood and lift up the front trunk cover while depressing the front trunk lever (1).



2. Remove the cover by pulling the upper part of the cover.



3. Remove the climate control air filter cover (2) by pulling out both sides of the cover (1).



4. Replace the climate control air filter.



5. Reassemble in reverse order of disassembly.

* NOTICE

When replacing the climate control air filter install it properly. Otherwise, the system may produce noise and the effectiveness of the filter may be reduced.

Wiper blade

Replacing the front wiper blade

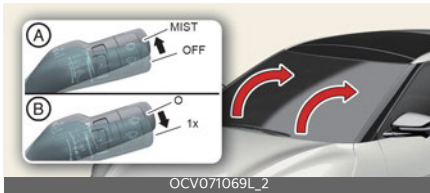

Operation

1. Turn off the vehicle.
2. Move the wiper switch to the single wiping (MIST/1x) position within 20 seconds.
3. Hold the wiper switch for more than 2 seconds.
4. Raise the wiper arm.
5. Lift the wiper blade clip up. Pull down the blade assembly and remove it.

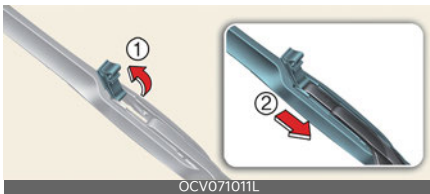

6. Install the new blade assembly.

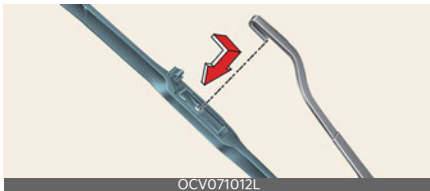

7. Upon starting the vehicle, the wiper arms will return to their normal operating position.

* INFORMATION

To prevent damage to the wiper arms or other components, have the wiper blade replaced by a professional workshop. Kia recommends visiting an authorized Kia dealer/service partner.

⚠ CAUTION

- Do not use gasoline, kerosene, paint thinner, or other solvents on or near them.
- Do not attempt to move the wipers manually.
- The use of a non-specified wiper blade could result in wiper malfunction and failure.
- Do not allow the wiper arm to fall against the windshield, since it may chip or crack the windshield.
- If the wiper arm receives too much force while pulling the blade, the center part may be damaged.
- The wiper could not operate for approximately 10 seconds when the wiper is operated without washer fluid or the blades are frozen. This is not a malfunction, it is a wiper protection system activated by motor overload circuit within the wiper motor.
- The front windshield should be cleaned with water hose and wiped with clean towel with wiper blades raised up. Also, the wiper blades should be wiped clean when the grease or wax is applied to the blades.

* NOTICE

Commercial hot waxes applied by automatic car washes have been known to make the windshield difficult to clean.

Battery

For best battery service

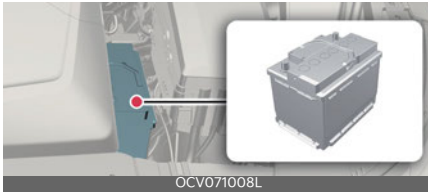

- Keep the battery securely mounted.
- Keep the top of the battery clean and dry.
- Keep the terminals and connections clean, tight, and coated with petroleum jelly or terminal grease.
- Immediately rinse any electrolyte spilled from the battery using a solution of water and baking soda.
- If the vehicle is not going to be used for an extended period, disconnect the battery cables.

⚠ WARNING



Always read the following instructions carefully when handling a battery.



Keep lighted cigarettes and all other flames or sparks away from the battery.



Hydrogen, a highly combustible gas, is always present in battery cells and may explode if ignited.



Keep batteries out of the reach of children because batteries contain highly corrosive SULFURIC ACID. Do not allow battery acid to contact your skin, eyes, clothing or paint finish.



If any electrolyte gets into your eyes, flush your eyes with clean water for at least 15 minutes and get immediate medical attention. If electrolyte gets on your skin, thoroughly wash the contacted area. If you feel pain or burning sensation, get medical attention immediately.



Wear eye protection when charging or working near a battery. Always provide ventilation when working in an enclosed space.



An inappropriately disposed battery can be harmful to the environment and human health. Dispose the battery according to your local law(s) or regulation.

- When lifting a plastic-cased battery, excessive pressure on the case may cause battery acid to leak, resulting in personal injury. Lift with a battery carrier or with your hands on opposite corners.
- Never attempt to recharge the battery when the battery cables are connected.
- The electrical ignition system works with high voltage. Never touch these components with the **READY** indicator ON or when the EV button is in the ON position.

Failure to follow the above warnings can result in serious bodily injury or death.

⚠ CAUTION

If you connect unauthorized electronic devices to the battery, the battery may be discharged. Never use unauthorized devices.

*** NOTICE**

Your vehicle is equipped with maintenance free battery. If your vehicle is equipped with the battery marked with LOWER and UPPER on the side, you can check the electrolyte level. The electrolyte level should be between LOWER and UPPER. If the electrolyte level is low, it needs to add distilled (demineralized) water (Never add sulfuric acid or other electrolyte). When refill, be careful not to splash the battery and adjacent components. And do not overfill the battery

cells. It can cause corrosion on other parts. Make sure that the cell caps are tightened.

Contact a professional workshop. Kia recommends visiting an authorized Kia dealer/service partner.

Battery capacity label

Example



* The actual battery label in the vehicle may differ from the illustration.

- 1 The Kia model name of battery
- 2 The nominal capacity (in Ampere hours)
- 3 The nominal reserve capacity (in min.)
- 4 The nominal voltage
- 5 The cold-test current in amperes by SAE
- 6 The cold-test current in amperes by EN

Battery recharging

Your vehicle has a maintenance-free, calcium-based battery.

- If the battery becomes discharged in a short time recharge it by slow charging (trickle) for 10 hours.
- If the battery gradually discharges because of high electric load while the vehicle is being used, recharge it at 20~30 A for 2 hours.

⚠ WARNING

- When recharging the battery, observe the following precautions:
 - The battery must be removed from the vehicle and placed in an area with good ventilation.
 - Do not allow cigarettes, sparks, or flame near the battery.
 - Watch the battery during charging, and stop or reduce the charging rate if the battery cells begin gassing (boiling) violently or if the temperature of the electrolyte of any cell exceeds 49°C (120°F).
 - Wear eye protection when checking the battery during charging.
 - Disconnect the battery charger in the following order.
 1. Turn off the battery charger main switch.
 2. Unhook the negative clamp from the negative battery terminal.
 3. Unhook the positive clamp from the positive battery terminal.
- Before performing maintenance or recharging the battery, turn off all accessories and stop the vehicle.
- The negative battery cable must be removed first and installed last when the battery is disconnected.
- We recommend that you use batteries for replacement from an authorized Kia dealer/service partner.

Reset items

Items should be reset after the battery has been discharged or the battery has been disconnected.

- Auto up/down window
- Wide sunroof
- Trip computer
- Climate control system
- Integrated Memory System
- Audio

Tires and wheels

Tire care

For proper maintenance, safety, and maximum electric energy economy, you must always maintain recommended tire inflation pressures and stay within the load limits and weight distribution recommended for your vehicle.

Recommended cold tire inflation pressures



All specifications (sizes and pressures) can be found on a label attached to the vehicle.

* INFORMATION

All tire pressures (including the spare) should be checked when the tires are cold. "Cold Tires" means the vehicle has not been driven for at least three hours or driven less than 1.6 km (1 mile).

Checking tire inflation pressure

- Remove the valve cap from the tire valve stem. Press the tire gauge firmly onto the valve to get a pressure measurement. If the pressure is low, add air until you reach the recommended amount.
- If you overfill the tire, release air by pushing on the metal stem in the center of the tire valve. Be sure to put the valve caps back on the valve stems.

⚠ WARNING

- Overinflation or underinflation can reduce tire life, adversely affect vehicle handling, and lead to sudden tire failure. This could result in loss of vehicle control and potential injury.
 - Severe underinflation (70 kPa (10 psi) or more) can lead to severe heat build-up, causing blowouts, tread separation and other tire failures that can result in the loss of vehicle control leading to severe injury or death. This risk is much higher on hot days and when driving for long periods at high speeds.
 - Inspect your tires frequently for proper inflation as well as wear and damage. Always use a tire pressure gauge.
 - Tires with too much or too little pressure wear unevenly causing poor handling, loss of vehicle control, and sudden tire failure leading to accidents, injuries, and even death. The recommended cold tire pressure for your vehicle can be found in this manual and on the tire label located on the driver's side center pillar.
 - Worn tires can cause accidents. Replace tires that are worn, show uneven wear, or are damaged.
 - Remember to check the pressure of your spare tire. Kia recommends that you check the spare every time you check the pressure of the other tires on your vehicle.
- your tire pressures at the proper levels. If a tire frequently needs refilling, have the system checked by a professional workshop. Kia recommends to visit an authorized Kia dealer/service partner.
- Overinflation produces a harsh ride, excessive wear at the center of the tire tread, and a greater possibility of damage from road hazards.
 - Warm tires normally exceed recommended cold tire pressures by 28 to 41 kPa (4 to 6 psi). Do not release air from warm tires to adjust the pressure or the tires will be underinflated.
 - Be sure to reinstall the tire inflation valve caps. Without the valve cap, dirt or moisture could get into the valve core and cause air leakage. If a valve cap is missing, install a new one as soon as possible.
 - Always observe the following:
 - Check tire pressure when the tires are cold. (After vehicle has been parked for at least three hours or hasn't been driven more than 1.6 km (one mile) since startup.)
 - Check the pressure of your spare tire each time you check the pressure of other tires.
 - Never overload your vehicle. Be careful not to overload a vehicle luggage rack if your vehicle is equipped with one.
 - Worn, old tires can cause accidents. If your tread is badly worn, or if your tires have been damaged, replace them.

⚠ CAUTION

- Underinflation also results in excessive wear, poor handling and reduced electric energy economy. Wheel deformation also is possible. Keep

Tire rotation

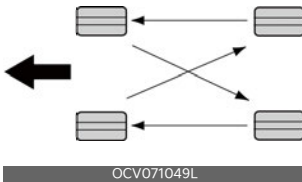

To equalize tread wear, it is recommended that the tires be rotated every 10,000 km (6,500 miles) or sooner if irregular wear develops.

⚠ WARNING

- Do not use the compact spare tire for tire rotation.
- Do not mix bias ply and radial ply tires under any circumstances. This may cause unusual handling characteristics that could result in death, severe injury, or property damage.

*** NOTICE**

Rotate radial tires that have an asymmetric tread pattern only from front to rear and not from right to left.

Wheel alignment and tire balance

The wheels on your vehicle were aligned and balanced carefully at the factory to give you the longest tire life and best overall performance.

If you notice your vehicle vibrating when driving on a smooth road, your wheels may need to be rebalanced.

⚠ CAUTION

Improper wheel weights can damage your vehicle's aluminum wheels. Use only approved wheel weights.

Tire replacement



A: Tread wear indicator

If the tire is worn evenly, a tread wear Indicator will appear as a solid band across the tread.

This shows there is less than 1.6 mm (1/16 in.) of tread left on the tire. Replace the tire when this happens.

Do not wait for the band to appear across the entire tread before replacing the tire.

Compact spare tire replacement (if equipped)

A compact spare tire has a shorter tread life than a regular size tire. Replace it when you can see the tread wear indicator bars on the tire. The replacement compact spare tire should be the same size and design tire as the one provided with your new vehicle and should be mounted on the same compact spare tire wheel. The compact spare tire is not designed to be mounted on a regular size wheel, and the compact spare tire wheel is not designed for mounting a regular size tire.

⚠ WARNING

To reduce the chance of serious or fatal injuries from an accident caused by tire failure or loss of vehicle control:

- Replace tires that are worn, show uneven wear, or are damaged. Worn tires can cause loss of braking effec-

tiveness, steering control, and traction.

- Do not drive your vehicle with too little or too much pressure in your tires. This can lead to uneven wear and tire failure.
- When replacing tires, never mix radial and bias-ply tires on the same car. You must replace all tires (including the spare) if moving from radial to bias-ply tires.
- It is best to replace all four tires at the same time. If that is not possible, or necessary, then replace the two front or two rear tires as a pair.
Replacing just one tire can seriously affect your vehicle's handling.
- Using tires and wheels other than the recommended sizes could cause unusual handling characteristics and poor vehicle control, resulting in a serious accident.
- Wheels that do not meet Kia's specifications may fit poorly and result in damage to the vehicle or unusual handling and poor vehicle control.
- The ABS works by comparing the speed of the wheels. The tire size affects wheel speed. When replacing tires, all 4 tires must use the same size, type, construction and tread pattern originally supplied with the vehicle. Using tires of a different size can cause the ABS (Anti-lock Brake System) and ESC (Electronic Stability Control) to work irregularly.

⚠ CAUTION

When replacing the tires, recheck and tighten the wheel nuts after driving about 50 km (31 miles) and recheck after driving about 1,000 km (620 miles). If the steering wheel shakes or

the vehicle vibrates while driving, the tire is out of balance. Align the tire balance. If the problem is not solved, contact a professional workshop. Kia recommends to visit an authorized Kia dealer/service partner.

*** NOTICE**

We recommend that when replacing tires, use the same originally supplied with the vehicles. If not, that affects driving performance.

Wheel replacement

Make sure the new wheels are equivalent to the original factory units in diameter, rim width and offset.

⚠ WARNING

A wheel that is not the correct size may adversely affect wheel and bearing life, braking and stopping abilities, handling characteristics, ground clearance, body-to-tire clearance, snow chain clearance, speedometer and odometer calibration, headlight aim and bumper height.

Tire traction

Tire traction can be reduced if you drive on worn tires, tires that are improperly inflated or on slippery road surfaces. Tires should be replaced when tread wear indicators appear. Slow down whenever there is rain, snow or ice on the road to reduce the possibility of losing control of the vehicle.

Tire maintenance

In addition to proper inflation, correct wheel alignment helps to decrease tire wear. If you find a tire is worn unevenly, have a professional workshop check the wheel alignment. Kia recommends to

visit an authorized Kia dealer/service partner.

When you have new tires installed, make sure they are balanced. This will increase vehicle ride comfort and tire life. Additionally, a tire should always be rebalanced if it is removed from the wheel.

Tire sidewall labeling

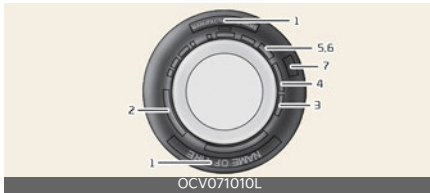

This information identifies and describes the fundamental characteristics of the tire and also provides the tire identification number (TIN) for safety standard certification. The TIN can be used to identify the tire in case of a recall.

1. Manufacturer or brand name

Manufacturer or brand name is shown.

2. Tire size designation

A tire's sidewall is marked with a tire size designation. You will need this information when selecting replacement tires for your vehicle.

Example tire size designation:

(These numbers are provided as an example only.)

P235/55R19 108T

235 - Tire width in millimeters.

55 - Aspect ratio. The tire's section height as a percentage of its width.

R - Tire construction code (Radial).

19 - Rim diameter in inches.

108 - Load Index, a numerical code associated with the maximum load the tire can carry.

T - Speed Rating Symbol. See the speed rating chart in this section for additional information.

Wheel size designation

Wheels are also marked with important information that you need if you ever have to replace one. The following explains what the letters and numbers in the wheel size designation mean.

Example wheel size designation:

7.5JX19

7.5 - Rim width in inches.

J - Rim contour designation.

19 - Rim diameter in inches.

Tire speed ratings

The chart below lists many of the different speed ratings currently being used for passenger car tires. The speed rating is part of the tire size designation on the sidewall of the tire. This symbol corresponds to that tire's designed maximum safe operating speed.

Speed Rating Symbol	Maximum Speed
S	180 km/h (112 mph)
T	190 km/h (118 mph)
H	210 km/h (130 mph)
V	240 km/h (149 mph)
W	270 km/h (168 mph)
Y	300 km/h (186 mph)

3. Checking tire life (TIN: Tire Identification Number)

Any tires that are over 6 years old, based on the manufacturing date, should be replaced by new ones. You can find the manufacturing date on the tire sidewall, displaying the DOT Code. The manufacturing date is designated by the last four digits (characters) of the DOT code.

DOT: XXXX XXXX OOOO

The front part of the DOT means a plant code number, tire size and tread pattern and the last four numbers indicate week and year manufactured.

For example, DOT XXXX XXXX 1622 represents that the tire was produced in the 16th week of 2022.

⚠ WARNING

Tires degrade over time, even when they are not being used. Regardless of the remaining tread, we recommend that tires be replaced after approximately 6 years of normal service. Heat caused by hot climates or frequent high loading conditions can accelerate the aging process. Failure to follow this warning can result in sudden tire failure, which could lead to a loss of control and an accident involving serious injury or death.

4. Tire ply composition and material

The number of layers or plies of rubber-coated fabric in the tire. Tire manufacturers also must indicate the materials in the tire, which include steel, nylon, polyester, and others. The letter "R" means radial ply construction; the letter "D" means diagonal or bias ply construction; and the letter "B" means belted-bias ply construction.

5. Maximum permissible inflation pressure

This number is the greatest amount of air pressure that should be put in the tire. Do not exceed the maximum permissible inflation pressure. Refer to "Tire specification and pressure label" on page 9-5.

6. Maximum load rating

This number indicates the maximum load in kilograms and pounds that can be carried by the tire. When replacing the tires on the vehicle, always use a tire that has the same load rating as the factory installed tire.

7. Uniform tire quality grading

Quality grades can be found where applicable on the tire sidewall between tread shoulder and maximum section width.

For example:

TREADWEAR 200

TRACTION AA

TEMPERATURE A

WARNING

- The traction grade assigned to this tire is based on straight ahead braking traction tests, and does not include acceleration, cornering, hydroplaning, or peak traction characteristics.
- The temperature grade for this tire is established for a tire that is properly inflated and not overloaded. Excessive speed, under inflation, or excessive loading, either separately or in combination, can cause heat build-up in tire and sudden tire failure. This can cause loss of vehicle control and serious injury or death.

Tread wear

The tread wear grade is a comparative rating based on the wear rate of the tire when tested under controlled conditions on a specified government test course. For example, a tire graded 150 would wear one-and-a-half times (1½) as well on the government course as a tire graded 100.

The relative performance of tires depends upon the actual conditions of their use, however, and may depart significantly from the norm due to variations in driving habits, service practices and differences in road characteristics and climate.

The tires available as standard or optional equipment on your vehicle may vary with respect to grade.

Traction - AA, A, B & C

The traction grades, from highest to lowest, are AA, A, B and C. Those grades represent the tire's ability to stop on wet pavement as measured under controlled conditions on specified government test surfaces of asphalt and concrete. A tire marked C may have poor traction performance.

Temperature -A, B & C

The temperature grades are A (the highest), B, and C, representing the tire's resistance to the generation of heat and its ability to dissipate heat when tested under controlled conditions on a specified indoor laboratory test wheel.

Sustained high temperature can cause the material of the tire to degenerate and reduce tire life, and excessive temperature can lead to sudden tire failure. Grades B and A represent higher levels of performance on the laboratory test wheel than the minimum required by law.

Low aspect ratio tire (if equipped)

Low aspect ratio tires, whose aspect ratio is lower than 50, are provided for sporty looks.

Because the low aspect ratio tires are optimized for handling and braking, it may be more uncomfortable to ride in and there is more noise compare with normal tires.

CAUTION

- Because the sidewall of the low aspect ratio tire is shorter than the normal, the wheel and tire of the low aspect ratio tire is easier to be damaged. So, follow the instructions below.
 - When driving on a rough road or off road, drive cautiously because tires and wheels may be damaged. And after driving, inspect tires and wheels.
 - When passing over a pothole, speed bump, manhole, or curb stone, drive slowly so that the tires and wheels are not damaged.
 - If the tire is impacted, inspect the tire condition or contact a professional workshop. Kia recommends to visit an authorized Kia dealer/service partner.
 - To prevent damage to the tire, inspect the tire condition and pressure every 3,000 km (2,000 miles).
- It is not easy to recognize the tire damage with your own eyes. But if there is the slightest hint of tire damage, even though you cannot see the tire damage with your own eyes, have the tire checked or replaced because the tire damage may cause air leakage from the tire.
- If the tire is damaged by driving on a rough road, off road, pothole, manhole, or curb stone, it will not be covered by the warranty.
- You can find out the tire information on the tire sidewall.

Fuses

Blade type



Cartridge type



Multi fuse

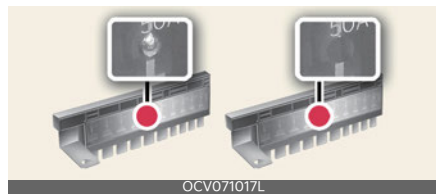

BFT

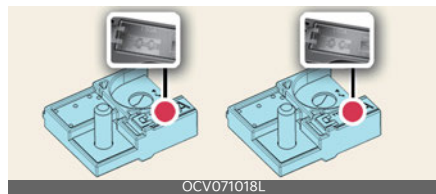

* Left: Normal, Right: Blown

* The actual fuse/relay panel label may differ.

Before replacing a blown fuse, disconnect the negative battery cable.

If the electrical system does not work, first check the driver's side fuse panel.

Always replace a blown fuse with one of the same rating.

If the replacement fuse blows, this indicates an electrical problem. Avoid using the system involved and immediately consult a professional workshop. Kia recommends to consult an authorized Kia dealer/service partner.

⚠ WARNING

- Never replace a fuse with anything but another fuse of the same rating.
- A higher capacity fuse could cause damage and possibly a fire.
- Never install a wire or aluminum foil instead of the proper fuse even as a temporary repair. It may cause extensive wiring damage and a possible fire.
- Do not arbitrarily modify or add-on electric wiring of the vehicle.

⚠ CAUTION

- When replacing a blown fuse or relay with a new one, make sure the new fuse or relay fits tightly into the clips. The incomplete fastening fuse or relay may cause the vehicle wiring and electric systems damage and a possible fire.
- Do not remove fuses, relays and terminals fastened with bolts or nuts. The fuses, relays and terminals may be fastened incompletely, and it may cause a possible fire. If fuses, relays and terminals fastened with bolts or nuts are blown, consult a professional workshop. Kia recommends to consult an authorized Kia dealer/service partner.
- Do not input any other objects except fuses or relays into fuse/relay terminals such as a driver or wiring. It may cause contact failure and system malfunction.

- Do not plug in screwdrivers or after-market wiring into the terminal originally designed for fuse and relays only. The electrical system and wiring of the vehicle interior may be damaged or burned due to contact failure.
- If you directly connect the wire on the taillight or replace the bulb which is over the regulated capacity to install trailers etc., the inner junction block can get burned.
- Do not use a screwdriver or any other metal object to remove fuses because it may cause a short circuit and damage the system.

*** NOTICE**

- When replacing fuse, press the EV button to the OFF position and turn off switches of all electrical devices then remove battery (-) terminal.
- The actual fuse/relay panel label may differ from equipped items.

Replacing inner panel fuse

Operation

1. Press the EV button to the OFF position and turn all other switches off.
2. Open the fuse panel cover.

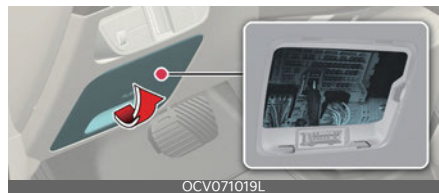

3. Pull the suspected fuse straight out. Use the removal tool (1) provided in the main fuse box in the motor compartment.



4. Check the removed fuse; replace it if it is blown. Spare fuses are provided in the instrument fuse panel (or in the motor compartment fuse panel).
5. Push in a new fuse of the same rating, and make sure it fits tightly in the clips.

*** INFORMATION**

If the headlights or taillights, stoplights, day time running lights (DRL) do not work and the fuses are OK, consult a professional workshop. Kia recommends to consult an authorized Kia dealer/service partner.

Replacing motor room fuse

Operation

- Press the EV button to the OFF position and turn all other switches off.
- Remove the fuse panel cover by pressing the tab and pulling the cover up.

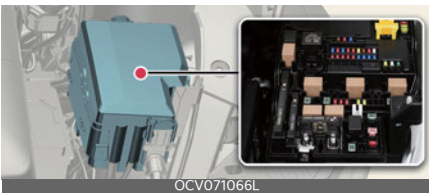

When the blade type fuse is disconnected, remove it by using the clip designed for changing fuses located in the motor room fuse box. Upon

- removal, securely insert reserve fuse of equal quantity.
- Check the removed fuse; replace it if it is blown. To remove or insert the fuse, use the fuse puller in the motor compartment fuse panel.
- Push in a new fuse of the same rating, and make sure it fits tightly in the clips. If it fits loosely, consult a professional workshop. Kia recommends to consult an authorized Kia dealer/service partner.

⚠ CAUTION

After checking the fuse panel in the motor compartment, securely install the fuse panel cover through the audible clicking sound. If not, electrical failures may occur from water contact.

Replacing main fuse (multi fuse)



Operation

- Turn off the vehicle.
- Disconnect the negative battery cable.
- Remove the nuts shown in the picture above.
- Replace the fuse with a new one of the same rating.
- Reinstall in the reverse order of removal.

⚠ CAUTION

Visually inspect the battery cap for secure closing. If the battery cap is not securely latched, the electrical system may be damaged to due influx of moisture into the system.

*** NOTICE**

- The electronic system may not function correctly even when the motor room and internal fuse box's individual fuses are not disconnected. In such case the cause of the problem may be disconnection of the main fuse (BFT type), which is located inside the positive battery terminal (+) cap. Since the main fuse is designed more intricately than other parts, visit a professional workshop. Kia recommends to visit the nearest authorized Kia dealer/service partner.
- If the multi fuse is blown, consult a professional workshop. Kia recommends to consult an authorized Kia dealer/service partner.

Fuse/relay panel description

Inside the fuse/relay panel covers, you can find the fuse/relay label describing fuse/relay name and capacity.

*** NOTICE**

Not all fuse panel descriptions in this manual may be applicable to your vehicle. It is accurate at the time of printing. When you inspect the fuse panel in your vehicle, refer to the fuse panel label.

Driver's side fuse panel

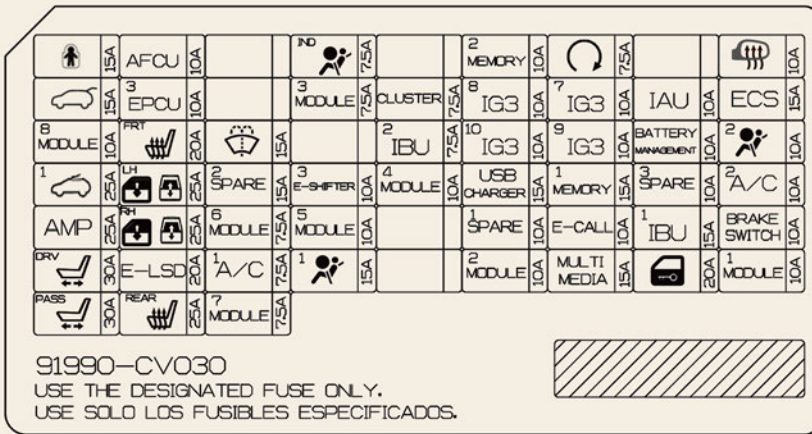





OCV071023L

ICU Junction Block

Fuse Name	Symbol	Fuse Rating	Circuit Protected
CHILD LOCK		15A	Child Lock Relay, Child Unlock Relay
AFCU	AFCU	10A	AFCU
A/BAG IND		7.5A	Overhead Console
MEMORY2	² MEMORY	10A	Fuse - MEMORY2, Mood Lamp Unit, Crash Pad Mood Lamp LH/RH, ADP, Head-Up Display, ADS Unit

Fuse Name	Symbol	Fuse Rating	Circuit Protected
START		7.5A	VCU, IBU (Integrated Body Control Unit)
HEATED MIRROR		10A	Driver/Passenger Outside Mirror Unit
TAILGATE OPEN		15A	Tailgate Latch
EPCU 3	³ EPCU	10A	Rear Inverter
MODULE3	³ MODULE	7.5A	Multifunction Switch, IBU (Integrated Body Control Unit), Stop Lamp Switch, Driver Door Module
CLUSTER	CLUSTER	7.5A	Head-Up Display, Instrument Cluster
IG3 8	⁸ IG3	10A	V2L Unit, ICCU, VCMS, Rear Electronic Oil Pump, CDM
IG3 7	⁷ IG3	10A	In-car Temperature Sensor, Audio/Video & Navigation Head Unit, A/C PTC (Positive Temperature Coefficient) Heater, A/C Control Module, Instrument Cluster
IAU	IAU	10A	Driver/Passenger Door Outside Handle
ECS	ECS	15A	Not Used
MODULE8	⁸ MODULE	10A	Driver/Passenger Power Seat Module, Driver/Passenger Manual Seat Switch
S/HEATER FRT	^{FRT} 	20A	Front Air Ventilation Seat Control Module, Front Seat Warmer Control Module
WASHER		15A	Multifunction Switch
IBU2	² IBU	7.5A	IBU (Integrated Body Control Unit)
IG3 10	¹⁰ IG3	10A	SCU (System Control Unit), Rear Inverter, BMU
IG3 9	⁹ IG3	10A	Not Used
BATTERY MAN- AGEMENT	^{BATTERY MANAGEMENT}	10A	BMU
AIR BAG2	² 	10A	SRS (Supplemental Restraint System) Control Module
SUNROOF1	¹ 	25A	Sunroof Motor
P/WINDOW LH	^{LH} 	25A	Driver Safety Power Window Module (LHD), Passenger Safety Power Window Module (RHD), Rear Power Window Switch LH
SPARE2 (IG2)	² SPARE (IG2)	15A	Not Used
E-SHIFTER 3	³ E-SHIFTER	10A	Electronic ATM (Automatic Transmission) Shift Dial
MODULE4	⁴ MODULE	10A	Front/Rear Corner Radar LH/RH, Front/Rear Inverter, ADAS Unit (Driving), VESS (Virtual Engine Sound System) Unit, Smart Cruise Control Radar, Front View Camera (ADAS), ADAS Unit, Console Upper Cover Switch
USB CHARGER	^{USB CHARGER}	15A	Driver/Passenger Seat USB Charger, Front Console USB Charger #1/#2
MEMORY1	¹ MEMORY	15A	Fuse - MEMORY2, Instrument Cluster, A/C Control Module, Console Mood Lamp (Upper/Lower), Console Floor Switch, Driver/Passenger Door Mood Lamp, Rear Door Mood Lamp LH/RH

Fuse Name	Symbol	Fuse Rating	Circuit Protected
SPARE3 (B+)	³ SPARE (B+)	10A	Not Used
A/C2	² A/C	10A	A/C Control Module, High Pressure Valve, Refrigerants Valve #1/#2 P/R Junction Block (Blower Relay), BSA Chiller #1, A/C Coolant Valve
AMP	AMP	25A	AMP (Amplifier)
P/WINDOW RH	^{RH} 	25A	Passenger Safety Power Window Module (LHD), Driver Safety Power Window Module (RHD), Rear Power Window Switch RH
MODULE6	⁶ MODULE	7.5A	IBU (Integrated Body Control Unit)
MODULE5	⁵ MODULE	10A	Data Link Connector, Electro Chromic Mirror, E-CALL Unit, ADP, Audio/Video & Navigation Head Unit, Crash Pad Switch, Head Lamp LH/RH, AMP (Amplifier), Smart Phone Wireless Charger, Driver/Passenger Power Seat Module, Front Air Ventilation Seat Control Module, Front Seat Warmer Control Rear Seat Warmer Control Module, Console Floor Switch, Auto Head Lamp Leveling Device Module, IFS (Intelligent Front-Lighting System) Module
SPARE1 (ACC)	¹ SPARE (ACC)	10A	Not Used
E-CALL	E-CALL	10A	E-CALL Unit
IBU1	¹ IBU	15A	IBU (Integrated Body Control Unit)
BRAKE SWITCH	BRAKE SWITCH	10A	Stop Lamp Switch, IBU (Integrated Body Control Unit)
P/SEAT DRV	^{DRV} 	30A	Driver Power Seat Switch, Driver Power Seat Module (With IMS (Integrated memory system))
A/C1	¹ A/C	7.5A	A/C Control Module
AIR BAG1	¹ 	15A	SRS (Supplemental Restraint System) Control Module
MODULE2	² MODULE	10A	AMP (Amplifier), ADP, P/E Junction Block (Power Outlet Relay), IBU (Integrated Body Control Unit), E-CALL Unit, ADAS Unit, Audio/Video & Navigation Keyboard, Audio/Video & Navigation Head Unit
MULTIMEDIA	MULTI MEDIA	15A	Audio/Video & Navigation Head Unit
DOOR LOCK		20A	Door Lock Relay, Door Unlock Relay, Dead Lock Relay
MODULE1	¹ MODULE	10A	Hazard Lamp Switch, Multifunction Switch, Data Link Connector, Rain Sensor, UIP Siren, UIP Sensor, PTG Unit, Driver Door Module, Driver/Passenger Outside Mirror Unit
P/SEAT PASS	^{PASS} 	30A	Passenger Power Seat Switch, Passenger Power Seat Module
S/HEATER RR	^{REAR} 	25A	Rear Seat Warmer Control Module

Motor compartment fuse panel

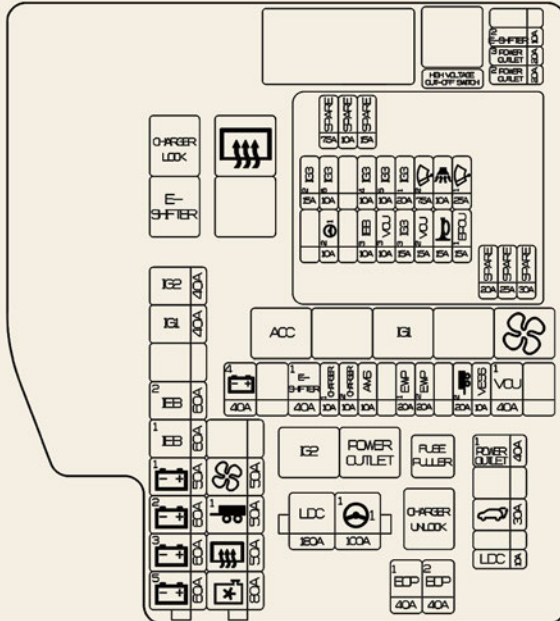
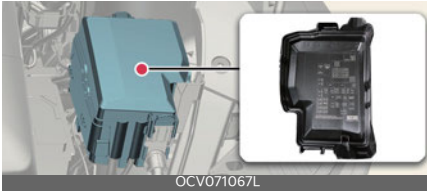











USE THE DESIGNATED FUSE AND RELAY ONLY
 ИСПОЛЬЗУЙТЕ ТОЛЬКО ПРЕДНАЗНАЧЕННЫЕ ПРЕДОХРАНИТЕЛИ И РЕЛЕ
 USE ONLY THE FUSES AND RELAYS SPECIFIED

91936-CV140





OCV071024L

Circuit (P/R Junction Block)

	Fuse Name	Symbol	Fuse Rating	Circuit Protected
MULTI FUSE-1	LDC	LDC	180A	P/R Junction (Fuse: P/OUTLET1, T/GATE, EOP1, EOP2)
	MDPS1	¹  1	100A	MDPS Unit * MDPS is the same as EPS (Electric Power Steering).
MULTI FUSE-3	B+5	⁵  5	60A	PCB Block (IG3 Main Relay, Fuse: WIPER1, EPCU1, B/ALARM, HORN, VCU2)
	B+3	³  3	60A	ICU Junction Block (Fuse: CHILD LOCK, AFCU, TAILGATE OPEN, EPCU 3, MODULE8, S/HEATER FRT, SUNROOF1, P/WINDOW LH, AMP, P/WINDOW RH, P/SEAT DRV, P/SEAT PASS, S/HEATER RR)
	B+2	²  2	60A	ICU Junction Block (IPS1, PS6, IPS8, IPS9, IPS10)
	B+1	¹  1	50A	ICU Junction Block (IPS2, IPS3, IPS5, IPS7, IPS13)
	IEB1	¹ IEB	60A	IEB Unit
	IEB2	² IEB	60A	IEB Unit
	IG1	IG1	40A	P/R Junction Block (ACC Relay, IG1 Relay)
	IG2	IG2	40A	P/R Junction Block (IG2 Relay)
	MULTI FUSE-2	C/FAN	 1	80A
RR HTD		 1	50A	P/R Junction Block (Rear Heated Relay)
TRAILER1		¹  1	50A	Trailer Connector Unit
BLOWER		 1	50A	P/R Junction Block (Blower Relay)

Fuse Name	Symbol	Fuse Rating	Circuit Protected
B+4		40A	ICU Junction Block (Long Term Load Latch Relay, Fuse: 1AU, ECS, BATTERY MANAGEMENT, AIR BAG2, MEMORY1, SPARE3 (B+), A/C2, E-CALL, IBU1, BRAKE SWITCH, MULTIMEDIA, DOOR LOCK, MODULE1)
E-SHIFTER1	¹ E-SHIFTER	40A	P/R Junction Block (E-Shifter Relay, Fuse: E-SHIFTER2)
CHARGER1	¹ CHARGER	10A	P/R Junction Block (Charger Lock Relay, Charger Unlock Relay), ICCU, VCMSCDM
CHARGER2	¹ CHARGER	10A	CDM
AMS	AMS	10A	12V Battery Sensor
EWP1	¹ EWP	20A	Electronic Water Pump #1
EWP2	² EWP	20A	Electronic Water Pump #2
TRAILER2		20A	Trailer Connector Unit
VESS	VESS	10A	VESS Unit
VCU1	¹ VCU	40A	VCU
P/OUTLET1	¹ POWER OUTLET	40A	Power Outlet Relay
T/GATE		30A	PTG Unit
EOP1	¹ EOP	40A	Rear Electronic Oil Pump
EOP2	² EOP	40A	Front Electronic Oil Pump (4WD)
E-SHIFTER2	² E-SHIFTER	10A	E-Shifter Relay, SCU, Electronic ATM Shift Dial
P/OUTLET3	³ POWER OUTLET	20A	Rear Power Outlet
P/OUTLET2	² POWER OUTLET	20A	Front Power Outlet



PCB Block

Fuse Name	Symbol	Fuse Rating	Circuit Protected
WIPER1	¹ 	25A	PCB (Printed Circuit Board) Block (Wiper Main Relay)
EPCU1	¹ EPCU	15A	Front Inverter (4WD)
B/ALARM		10A	PCB (Printed Circuit Board) Block (Burglar Alarm Horn Relay)
HORN		15A	PCB (Printed Circuit Board) Block (Horn Relay)
WIPER2	² 	7.5A	IBU (Integrated Body Control Unit)
VCU2	² VCU	15A	VCU
IG3 1	¹ IG3	20A	ICU Junction Block (Fuse: IG3 8, IG3 7, IG3 10, IG3 9)
IG3 3	³ IG3	15A	Electronic Water Pump

Fuse Name	Symbol	Fuse Rating	Circuit Protected
IG3 5	⁵ IG3	10A	BMS (Battery Management System) Coolant 3Way Valve
VCU3	³ VCU	10A	VCU
IG3 4	⁴ IG3	10A	Electronic Water Pump #1, #2, Electronic A/C Compressor
IEB3	³ IEB	10A	IEB Unit
IG3 6	⁶ IG3	10A	Cooling Fan Motor, Front Electronic Oil Pump (4WD)
MDPS2	²  1	10A	MDPS Unit * MDPS is the same as EPS (Electric Power Steering).
IG3 2	² IG3	15A	Front Inverter (4WD), VCU

Relay

Refer to the following table for the relay type.

Relay Name	Symbol	TYPE
Charger Lock Relay	CHARGER LOCK	MICRO
E-Shifter Relay	E-SHIFTER	MICRO
Rear Heated Relay		MINI
ACC Relay	ACC	MICRO
IG1 Relay	IG 1	MICRO
Blower Relay		MICRO
IG2 Relay	IG2	MICRO
Power Outlet Relay	POWER OUTLET	MICRO
Charger Unlock Relay	CHARGER UNLOCK	MICRO

Lamps

Bulb replacement precautions

Turn off the vehicle at a safe place, firmly apply the side brake and take out the battery's negative (-) terminal. Use only the bulbs of the specified wattage.

Lamp part malfunction due to network failure

Lamp part malfunction may be caused by network failure or vehicle electrical control system malfunction. If there is a problem, have the system serviced by a professional workshop. Kia recommends to visit an authorized Kia dealer/service partner.

Lamp part malfunction due to electrical control system stabilization

A normally functioning lamp may flicker momentarily. This momentary occurrence is due to stabilization function of the vehicle's electrical control system. If the lamp soon returns to normal, the vehicle does not require service.

However, if the lamp goes out after the momentary flickering, or the flickering continues, have the system serviced by a professional workshop. Kia recommends to visit an authorized Kia dealer/service partner.

⚠ WARNING

- Prior to working on the light, firmly apply the parking brake, press the EV button to the OFF position and turn off the lights to avoid sudden movement of the vehicle and burning your fingers or receiving an electric shock.
- Be sure to replace the burned out bulb with one of the same wattage

rating. Otherwise, it may cause extensive wiring damage and possible fire.

- Be aware the bulbs may be hot and may burn your fingers.

⚠ CAUTION

- If you don't have necessary tools, the correct bulbs and the expertise, consult a professional workshop. Kia recommends to consult an authorized Kia dealer/service partner.
- In many cases, it is difficult to replace vehicle light bulbs because other parts of the vehicle must be removed before you can get to the bulb. This is especially true if you have to remove the headlight assembly to get to the bulb(s). Removing/installing the headlight assembly can result in damage to the vehicle.
- If unauthentic parts or substandard lights are used when changing lights, it may lead to fuse disconnection and malfunction, and other wiring damages.
- Do not install extra lamps or LED to the vehicle. If supplementary lights are installed, it may lead to lamp malfunction and flickering of the lights. In addition, the fuse box and other wiring may be damaged.

*** NOTICE**

- If the light bulb or lamp connector is removed from an operating lamp activated by electricity, the fuse box's electronic device may scan it as a malfunction. Therefore, a lamp malfunction history may be recorded in Diagnostic Trouble Code (DTC) in the fuse box.

- It is normal for an operating lamp may blink temporarily. Since this occurrence is due stabilization function of the vehicle's electronic control device, if the lamp lights up normally after temporary blinking, there is no problem in the vehicle.

However, if the lamp continues to blink several times or turn off completely, there may be an error in the vehicle's electronic control device. In this case, have the vehicle checked by a professional workshop immediately. Kia recommends to visit an authorized Kia dealer/service partner.

- After an accident or after the headlight assembly is reinstalled, have the headlight aiming adjusted by a professional workshop. Kia recommends to visit an authorized Kia dealer/service partner.
- After driving in heavy rain or washing, headlamp and taillamp lenses could appear frosty. This condition is caused by the temperature difference between the lamp inside and outside. This is similar to the condensation on your windows inside your vehicle during the rain and doesn't indicate a problem with your vehicle. If the water leaks into the lamp bulb circuitry, have the vehicle checked by a professional workshop. Kia recommends to visit an authorized Kia dealer/service partner.

demand several technical solutions (ex. automatic change system, adhesive sheet, down aiming). This headlamps are designed not to dazzle opposite drivers. So, you need not change your headlamps in a country with opposite traffic direction.

Light position (Front)

Head lamp - Type A

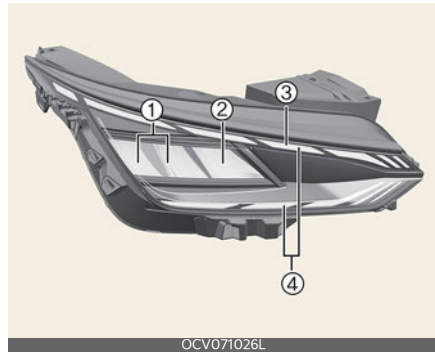

Head lamp - Type B



- Headlamp (Low) (LED type)
- Headlamp (High) (LED type)
- Front turn signal lamp (LED type)
- Day time running lamp/Position lamp (LED type)

* NOTICE

Traffic Change (For Europe)

The low beam light distribution is asymmetric. If you go abroad to a country with opposite traffic direction, this asymmetric part will dazzle oncoming car driver. To prevent dazzle, ECE regulation

Light position (Rear)

Type A

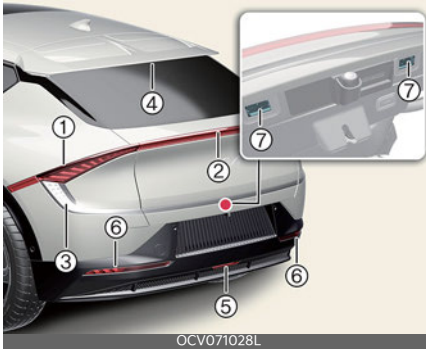

Type B



- 1 Stop and tail lamp (LED type)
- 2 Tail lamp (LED type)
- 3 Rear turn signal lamp (LED type)
- 4 High mounted stop lamp (LED type)
- 5 Backup lamp (LED type)
- 6 Rear fog lamp (LED type)
- 7 License plate lamp (LED type)

Light position (Side)



- 1 Side repeater lamp (LED type)

Replacing lights (LED type, except glove box lamp)

If a lamp does not operate, have your vehicle checked by a professional workshop. Kia recommends to visit an authorized Kia dealer/service partner.

The LED lamp cannot be replaced as a single unit because it is an integrated unit. The LED lamp has to be replaced with the unit.

A skilled technician should check or repair the LED lamp, for it may damage related parts of the vehicle.

Replacing glove box lamp (Bulb type)



Operation

- Using a flat-blade screwdriver, gently pry the lamp assembly from interior.
- Remove the cover from the lamp assembly.
- Remove the bulb by pulling it straight out.
- Install a new bulb in the socket.
- Install the cover to the lamp assembly.
- Install the lamp assembly to interior.

⚠ WARNING

Prior to working on the Interior lamps, ensure that the "OFF" button is depressed to avoid burning your fingers or receiving an electric shock.

Headlamp aiming (for Europe)

Headlamp aiming

Type A

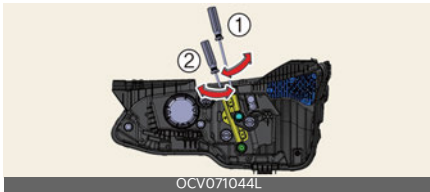

Type B

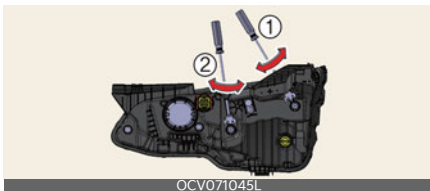

Operation

- Inflate the tires to the specified pressure and remove any loads from the vehicle except the driver, spare tire, and tools.
- The vehicle should be placed on a flat floor.
- Draw vertical lines (Vertical lines passing through respective head lamp centers) and a horizontal line (Horizontal line passing through center of head lamps) on the screen.
- With the head lamp and battery in normal condition, aim the head lamps so the brightest portion falls on the horizontal and vertical lines.
- To aim the low beam left or right, turn the screwdriver (1) clockwise or counterclockwise. To aim the low beam up or down, turn the screwdriver (2) clockwise or counterclockwise.

Aiming point

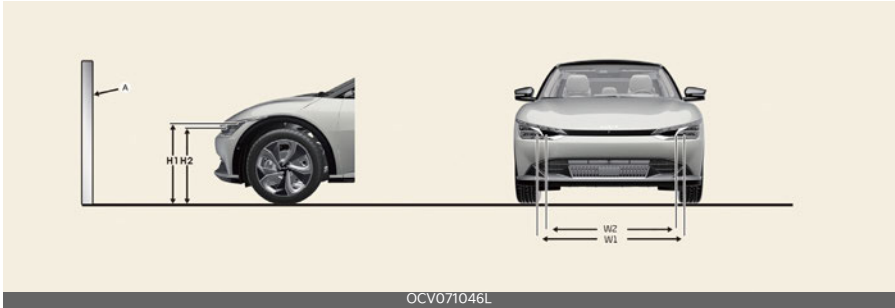

* A: Screen

Vehicle condition		Head lamp (LED type)			
		Ground Height		Distance between lamps	
		H1 (LOW)	H2 (HIGH)	W1 (LOW)	W2 (HIGH)
without driver [mm (in)]	Type A	708 (27.9)	698 (27.5)	1,610 (63.4)	1,416 (55.8)
	Type B	734 (28.9)	679 (26.7)	1,572 (61.9)	1,526 (60.5)
with driver [mm (in)]	Type A	698 (27.5)	688 (27.1)	1,610 (63.4)	1,416 (55.8)
	Type B	724 (28.5)	669 (26.3)	1,572 (61.9)	1,526 (60.5)

Head lamp low beam (LHD Vehicle)

Based on 10m screen

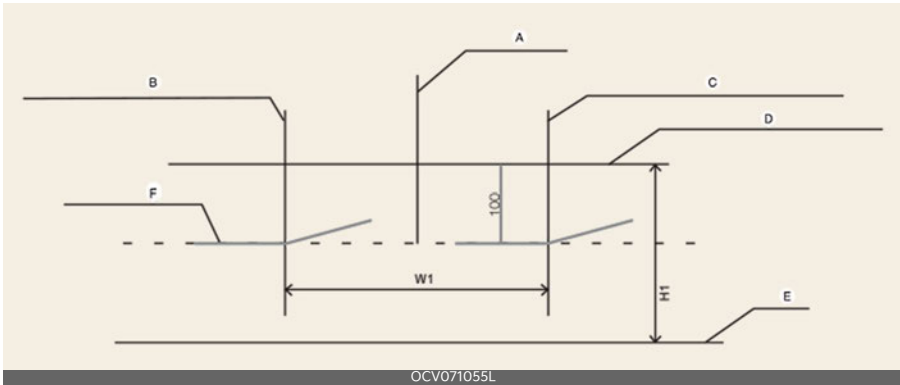

OCV071055L

- A: Vehicle axis
- B: Vertical line of the left head lamp bulb center
- C: Vertical line of the right head lamp bulb center
- D: Horizontal line of head lamp bulb center
- E: Ground
- F: Cut-Off line

Operation

- Turn the low beam on without driver aboard.
- The cut-off line should be projected in the cut-off line shown in the picture.
- When aiming the low beam, vertical aiming should be adjusted after adjusting the horizontal aiming.
- Disengage the parking brake and put the gear in N (Neutral), in addition, if head-lamp leveling device is equipped, adjust the headlamp leveling device switch to 'O'.

Head lamp low beam (RHD Vehicle)

Based on 10m screen

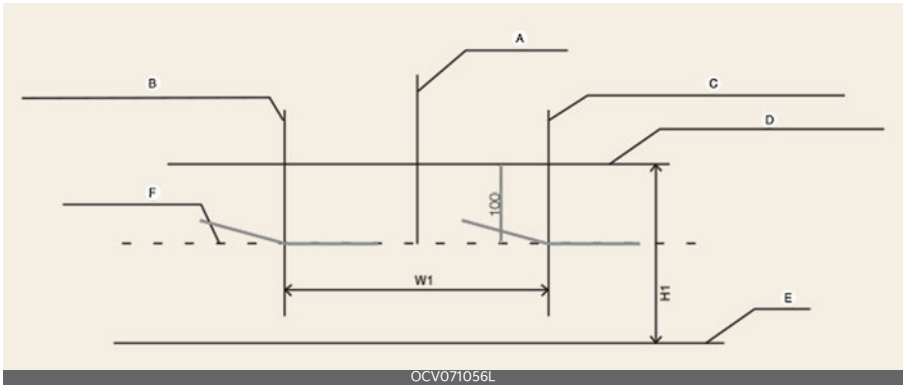

- A: Vehicle axis
- B: Vertical line of the left head lamp bulb center
- C: Vertical line of the right head lamp bulb center
- D: Horizontal line of head lamp bulb center
- E: Ground
- F: Cut-Off line

Operation

- Turn the low beam on without driver aboard.
- The cut-off line should be projected in the cut-off line shown in the picture.
- When aiming the low beam, vertical aiming should be adjusted after adjusting the horizontal aiming.
- Disengage the parking brake and put the gear in N (Neutral), in addition, if head-lamp leveling device is equipped, adjust the headlamp leveling device switch to 'O'.

Appearance care

Exterior care

Exterior general caution

Read all warning and caution statements that appear on the label and follow the label directions when using any chemical cleaner or polish.

* NOTICE

If you park the vehicle around a stainless signboard or windshield building etc., the plastic exterior trim (bumper, spoiler, garnish, lamp, outside mirror etc.) may be damaged by reflected sunlight from the external structure. To avoid damaging the plastic exterior trim, park the vehicle away from the areas where the reflected light may occur or use a vehicle cover. (Depending on the vehicle, the type of exterior trim applied such as spoiler may differ.)

Finish maintenance

Washing

To help protect your vehicle's finish from rust and deterioration, wash it thoroughly and frequently at least once a month with lukewarm or cold water.

If you use your vehicle for off-road driving, you should wash it after each off-road trip. Pay special attention to the removal of any accumulation of salt, dirt, mud, and other foreign materials. Make sure the drain holes in the lower edges of the doors and rocker panels are kept clear and clean. Insects, tar, tree sap, bird droppings, industrial pollution and similar deposits can damage your vehicle's finish if not removed immediately.

Even prompt washing with plain water may not completely remove all these deposits. A mild soap, safe for use on painted surfaces, may be used. After washing, rinse the vehicle thoroughly with lukewarm or cold water. Do not allow soap to dry on the finish.

⚠ WARNING

After washing the vehicle, test the brakes while driving slowly to see if they have been affected by water. If braking performance is impaired, dry the brakes by applying them lightly while maintaining a slow forward speed.

⚠ CAUTION

- Do not use strong soap, chemical detergents or hot water, and do not wash the vehicle in direct sunlight or when the body of the vehicle is warm.
- Be careful when washing the side windows of your vehicle. Especially, with high-pressure water, water may leak through the windows and wet the interior.
- To prevent damage to the plastic parts and lamps, do not clean with chemical solvents or strong detergents.

High-pressure washing

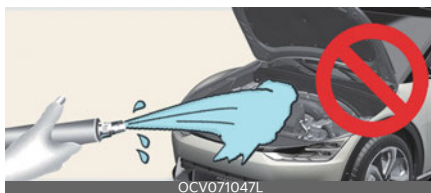

- When using high-pressure washers, make sure to maintain sufficient distance from the vehicle.

Insufficient clearance or excessive pressure can lead to component damage or water penetration.

- Do not spray the camera, sensors or its surrounding area directly with a high pressure washer. Shock applied from high pressure water may cause the device to not operate normally.
- Do not bring the nozzle tip close to boots (rubber or plastic covers) or connectors as they may be damaged if they come into contact with high pressure water.

⚠ CAUTION

- Water washing in the motor compartment including high pressure water washing may cause the failure of electrical circuits located in the motor compartment.
- Never allow water or other liquids to come in contact with electrical/electronic components inside the vehicle as this may damage them.

*** NOTICE**

Matte paint finish vehicle (if equipped)

Automatic car wash which uses rotating brushes should not be used as this can damage the surface of your vehicle. A steam cleaner which washes the vehicle surface at high temperature may result the oil to adhere and leave stains that is difficult to remove.

Use a soft cloth (e.g. microfiber towel or sponge) when washing your vehicle and dry with a microfiber towel. When you hand wash your vehicle, you should not use a cleaner that finishes with wax. If the vehicle surface is too dirty (sand, dirt, dust, contaminant, etc.), clean the

surface with water before washing the car.

Waxing

Wax the vehicle when water will no longer bead on the paint.

Always wash and dry the vehicle before waxing. Use a good quality liquid or paste wax, and follow the manufacturer's instructions. Wax all metal trim to protect it and to maintain its luster.

Removing oil, tar, and similar materials with a spot remover will usually strip the wax from the finish. Be sure to re-wax these areas even if the rest of the vehicle does not yet need waxing. Do not apply wax on embossed unpainted unit, as it may tarnish the unit.

⚠ CAUTION

- Wiping dust or dirt off the body with a dry cloth will scratch the finish.
- Do not use steel wool, abrasive cleaners, acid detergents or strong detergents containing high alkaline or caustic agents on chrome-plated or anodized aluminum parts. This may result in damage to the protective coating and cause discoloration or paint deterioration.

*** NOTICE**

Matte paint finish vehicle (if equipped)

Do not use any polish protector such as a detergent, an abrasive and a polish. In case wax is applied, remove the wax immediately using a silicon remover and if any tar or tar contaminant is on the surface use a tar remover to clean. How-

ever, be careful not to apply too much pressure on the painted area.

Finish damage repair

Deep scratches or stone chips in the painted surface must be repaired promptly. Exposed metal will quickly rust and may develop into a major repair expense.

* NOTICE

- If your vehicle is damaged and requires any metal repair or replacement, be sure the body shop applies anti-corrosion materials to the parts repaired or replaced.
- **Matte paint finish vehicle (if equipped)**

In case of matte paint finish vehicles, it is impossible to modify only the damaged area and repair of the whole part is necessary. If the vehicle is damaged and painting is required, we recommend that you have your vehicle maintained and repaired by an authorized Kia dealer/service partner. Take extreme care, as it is difficult to restore the quality after the repair.

Bright-metal maintenance

- To remove road tar and insects, use a tar remover, not a scraper or other sharp object.
- To protect the surfaces of bright metal parts from corrosion, apply a coating of wax or chrome preservative and rub to a high luster.
- During winter weather or in coastal areas, cover the bright metal parts with a heavier coating of wax or preservative. If necessary, coat the parts

with non-corrosive petroleum jelly or other protective compound.

Underbody maintenance

Corrosive materials used for ice and snow removal and dust control may collect on the underbody. If these materials are not removed, accelerated rusting can occur on underbody parts such as the frame, floor pan, even though they have been treated with rust protection.

Thoroughly flush the vehicle underbody and wheel openings with lukewarm or cold water once a month, after off-road driving and at the end of each winter. Pay special attention to these areas because it is difficult to see all the mud and dirt. It will do more harm than good to wet down the road grime without removing it. The lower edges of the doors, rocker panels, and frame members have drain holes that should not clog with dirt; trapped water in these areas can cause rusting.

⚠ WARNING

After washing the vehicle, test the brakes while driving slowly to see if they have been affected by water. If braking performance is impaired, dry the brakes by applying them lightly while maintaining a slow forward speed.

Aluminum wheel maintenance

The aluminum wheels are coated with a clear protective finish.

- Do not use any abrasive cleaner, polishing compound, solvent, or wire brushes on aluminum wheels. They may scratch or damage the finish.
- Clean the wheel when it has cooled.

- Use only a mild soap or neutral detergent, and rinse thoroughly with water. Also, be sure to clean the wheels after driving on salted roads. This helps prevent corrosion.
- Avoid washing the wheels with high-speed car wash brushes.
- Do not use any alkaline or acid detergent. It may damage and corrode the aluminum wheels coated with a clear protective finish.

Corrosion protection

Protecting your vehicle from corrosion

By using the most advanced design and construction practices to combat corrosion, we produce vehicles of the highest quality. However, this is only part of the job. To achieve the longterm corrosion resistance your vehicle can deliver, the owner's cooperation and assistance is also required.

Common causes of corrosion

The most common causes of corrosion on your vehicle are:

- Road salt, dirt and moisture that is allowed to accumulate underneath the vehicle.
- Removal of paint or protective coatings by stones, gravel, abrasion or minor scrapes and dents which leave unprotected metal exposed to corrosion.

High-corrosion areas

If you live in an area where your vehicle is regularly exposed to corrosive materials, corrosion protection is particularly important. Some of the common causes

of accelerated corrosion are road salts, dust control chemicals, ocean air and industrial pollution.

Moisture breeds corrosion

Moisture creates the conditions in which corrosion is most likely to occur. For example, corrosion is accelerated by high humidity, particularly when temperatures are just above freezing. In such conditions, the corrosive material is kept in contact with the vehicle's surface by moisture that evaporate slowly. Mud is particularly corrosive because it dries slowly and holds moisture in contact with the vehicle. Although the mud appears to be dry, it can still retain moisture and promote corrosion. High temperatures can also accelerate corrosion of parts that are not properly ventilated so the moisture can be dispersed.

Keep your vehicle clean and free of mud or accumulations of other materials. This applies not only to the visible surfaces but particularly to the underside of the vehicle.

To help prevent corrosion

You can help prevent corrosion from getting started by observing the following:

Keep your vehicle clean

The best way to prevent corrosion is to keep your vehicle clean and free of corrosive materials. Attention to the underside of the vehicle is particularly important.

- If you live in a high-corrosion area - where road salts are used, near the ocean, areas with industrial pollution, acid rain, etc., you should take extra care to prevent corrosion. In winter,

hose off the underside of your vehicle at least once a month and be sure to clean the underside thoroughly when winter is over.

- When cleaning underneath the vehicle, give particular attention to the components under the fenders and other areas that are hidden from view. Do a thorough job; just dampening the accumulated mud rather than washing it away will accelerate corrosion rather than prevent it. Water under high pressure and steam are particularly effective in removing accumulated mud and corrosive materials.
- When cleaning lower door panels, rocker panels and frame members, be sure that drain holes are kept open so that moisture can escape and not be trapped inside to accelerate corrosion.

Keep your garage dry

Don't park your vehicle in a damp, poorly ventilated garage. This creates a favorable environment for corrosion. This is particularly true if you wash your vehicle in the garage or drive it into the garage when it is still wet or covered with snow, ice or mud. Even a heated garage can contribute to corrosion unless it is well ventilated so moisture is dispersed.

Keep paint and trim in good condition

Scratches or chips in the finish should be covered with "touch-up" paint as soon as possible to reduce the possibility of corrosion. If bare metal is showing through, the attention of a qualified body and paint shop is recommended.

Bird droppings are highly corrosive and may damage painted surfaces in just a few hours. Always remove bird droppings as soon as possible.

Don't neglect the interior

Moisture can collect under the floor mats and carpeting and cause corrosion. Check under the mats periodically to be sure the carpeting is dry. Use particular care if you carry fertilizers, cleaning materials or chemicals in the vehicle.

These should be carried only in proper containers and any spills or leaks should be cleaned up, flushed with clean water and thoroughly dried.

Interior care

Interior general precautions

* NOTICE

Prevent chemicals such as perfume, cosmetic oil, sun cream, hand cleaner, and air freshener from contacting the interior parts because they may cause damage or discoloration. If they do contact the interior parts, wipe them off immediately. If necessary, use a mixture of warm water and mild non-detergent cleaner (test all cleaners on a concealed area before use). Use proper car cleaner to clean interior parts.

▲ CAUTION

- Never allow water or other liquids to come in contact with electrical/electronic components inside the vehicle as this may damage them.
- When cleaning leather products (steering wheel, seats etc.), use neutral detergents or low alcohol content solutions. If you use high alcohol con-

tent solutions or acid/alkaline detergents, the color of the leather may fade or the surface may get stripped off.

Taking care of leather seats (if equipped)

- Our car seats are upholstered with a combination of artificial and genuine leather. The genuine leather is made from the outer skin of an animal, which goes through a special process to be available for use. Since it is a natural substance, each part differs in thickness or density. Also, wrinkles could appear depending on the temperature and humidity.
- Vacuum the seat periodically to remove dust and sand on the seat. It will prevent abrasion or damage of the leather and maintain its quality.
- Wipe the leather seat cover often with dry or soft cloth.
- Sufficient use of a leather protective may prevent abrasion of the cover and helps maintain the color. Be sure to read the instructions and consult a specialist when using leather coating or protective agents.
- Leather with bright colors is easily contaminated and clear in appearance. Clean the seats frequently.
- Avoid wiping with wet cloth. It may cause the surface to crack.

Cleaning the leather seats (if equipped)

- Remove all contaminations instantly. Refer to instructions below for removal of each contaminant.
- Cosmetic products
 - Apply cleansing cream on a cloth and wipe the contaminated point. Wipe off the cream with a wet cloth and remove water with a dry cloth.
- Beverages
 - Apply a small amount of neutral detergent and wipe until contaminations do not smear.
- Oil
 - Remove oil instantly with absorbable cloth and wipe with stain remover for leather only.
- Chewing gum
 - Harden the gum with ice and remove gradually.

Fabric seat cover using precautions (if equipped)

Clean the fabric seats regularly with a vacuum cleaner in consideration of fabric material characteristics. If they are heavily soiled with beverage stains, etc., use a suitable interior cleaner. To prevent damage to seat covers, wipe off the seat covers down to the seams with a large wiping motion and moderate pressure using a soft sponge or microfiber cloth.

Velcro closures on clothing or sharp objects may cause snagging or scratches on the surface of the seats. Make sure not to rub such objects against the surface.

Cleaning the upholstery and interior trim

Car interior surfaces

Remove dust and loose dirt from interior surfaces with a whisk broom or a vacuum cleaner. If necessary, clean interior surfaces with a mixture of warm water and mild non-detergent cleaner (test all cleaners on a concealed area before use).

Fabric

Remove dust and loose dirt from fabric with a whisk broom or vacuum cleaner. Clean with a mild soap solution recommended for upholstery or carpets. Remove fresh spots immediately with a fabric spot cleaner. If fresh spots do not receive immediate attention, the fabric can be stained and its color can be affected. Also, its fire-resistant properties can be reduced if the material is not properly maintained.

CAUTION

Using anything but recommended cleaners and procedures may affect the fabric's appearance and fire-resistant properties.

Cleaning the lap/shoulder belt webbing

Clean the belt webbing with any mild soap solution recommended for cleaning upholstery or carpet. Follow the instructions provided with the soap. Do not bleach or re-dye the webbing because this may weaken it.

Cleaning the interior window glass

If the interior glass surfaces of the vehicle become fogged (that is, covered with an oily, greasy or waxy film), they should be cleaned with a glass cleaner. Follow the directions on the glass cleaner container.

CAUTION

Do not scrape or scratch the inside of the rear window. This may result in damage of the rear window defroster grid.

Dimensions	9-2
Electric vehicle specifications	9-2
Volume and weight	9-2
Available front trunk weight.....	9-3
Air conditioning system.....	9-3
Bulb wattage	9-3
Tires and wheels	9-4
Recommended lubricants and capacities	9-4
Vehicle Identification Number (VIN).....	9-5
Vehicle certification label.....	9-5
Tire specification and pressure label.....	9-5
Motor number	9-6
Air conditioner compressor label	9-6
Refrigerant label.....	9-6
Declaration of conformity	9-6
How to check the symbol on the charging label (For Europe)	9-7

Specifications & Consumer information

Dimensions

Item		mm (in)	
Overall length	Type A	4,680 (184.3)	
	Type B (GT-Line)	4,695 (184.8)	
Overall width	Type A	1,880 (74.0)	
	Type B (GT-Line)	1,890 (74.4)	
Overall height		1,550 (61.0)	
Tread	Front	235/55 R19	1,628 (64.1)
		255/45 R20	1,623 (63.9)
	Rear	235/55 R19	1,637 (64.4)
		255/45 R20	1,632 (64.3)
Wheelbase		2,900 (114.2)	

Electric vehicle specifications

OBC: On-Board Battery Chargers

Items			Standard type		Extended type	
			2WD	4WD	2WD	4WD
Motor	Max. output (kW)	Front	-	53	-	74
		Rear	125	120	168	165
	Max. torque (Nm)	Front	-	255	-	255
		Rear	350	350	350	350
Battery (Lithium-ion)	Capacity (kWh)		58		77.4	
	Power output (kW)		195		253	
	Voltage (V)		523		697	
Charger (OBC)	Max. output (kW)	AC single phase	7		7	
		AC 3 phase	10.5		10.5	

Volume and weight

Region	Type	Gross Vehicle Weight		Luggage Volume	
		Standard range	Extended range	Min.	Max.
Except Australia, New Zealand	2WD	2,340 kg (5,159 lbs.)	2,425 kg (5,357 lbs.)	STD: 520 l (18.4 cu ft) OPT: 490 l (17.3 cu ft)	1300 l (45.9 cu ft)
	4WD	2,445 kg (5,390 lbs.)	2,530 kg (5,578 lbs.)		
For Australia, New Zealand	2WD	2,370 kg (5,225 lbs.)	2,455 kg (5,412 lbs.)		
	4WD	2,475 kg (5,456 lbs.)	2,560 kg (5,643 lbs.)		

Available front trunk weight

2WD	4WD
25 kg (55 lbs.)	10 kg (25 lbs.)

Air conditioning system

Item	Weight of volume (g)	Classification
Refrigerant	Type A	800±25
	Type B	850±25
Compressor lubricant	180±10	POE

Please contact a professional workshop for more details. Kia recommends to contact an authorized Kia dealer/service partner.

Bulb wattage

	Light bulb	Bulb type	Wattage (Watt)
Front	High beam	LED	LED
	Low beam	LED	LED
	Position and daytime running lamps	LED	LED
	Turn signal lamps	LED	LED
	Front trunk lamp	LED	LED
Rear	Stop and tail lamps	LED	LED
	Turn signal lamps	LED	LED
	Backup lamps	LED	LED
	Rear fog lamp	LED	LED
	High mounted stop lamp	LED	LED
	License plate lamps	LED	LED
Interior	Map lamps	LED	LED
	Room lamps	LED	LED
	Vanity mirror lamps	LED	LED
	Glove box lamp	W5W	5W
	Luggage lamp	LED	LED

Tires and wheels

*1. Load Index

*2. Speed Symbol

Item	Tire size	Wheel size	Load capacity		Speed capacity		Inflation pressure [bar (psi, kPa)]				Wheel lug nut torque kgf·m (lbf·ft, N·m)		
			L ¹	kg	SS ²	km/h	Normal load		Maximum load				
							Front	Rear	Front	Rear			
Full size tire	235/55R19	7.5J X 19"	105	925	V	240	2.5 (36, 250)		2.6 (38, 260)		2.9 (42, 290)		11-13 (79-94, 107-127)
	255/45R20	8.0J X 20"			H	210							

⚠ CAUTION

When replacing tires, use the same size originally supplied with the vehicle. Using tires of a different size can damage the related parts or make it work irregularly.

* NOTICE

- We recommend that when replacing tires, use the same originally supplied with the vehicles. If not, that affects driving performance.
- When driving in high altitude grades, it is natural for the atmospheric pressure to decrease. Therefore, please check the tire pressure and add more air when necessary.
 - Additionally required tire air pressure per km above sea level: 1.5 psi/km

Recommended lubricants and capacities

To help achieve proper vehicle performance and durability, use only lubricants of the proper quality.

These lubricants and fluids are recommended for use in your vehicle.

Lubricant			Volume (L)	Classification
Reduction gear fluid	2WD	Rear	Approx. 3.4-3.5	Kia Genuine ATF SP4M-1
	4WD	Front	Approx. 3.2-3.3	
		Rear	Approx. 3.4-3.5	
Brake fluid			As required (500 ± 20 cc)	SAE J1704 DOT-4 LV, FMVSS 116 DOT-4, ISO4925 CLASS-6
Coolant	Standard type	2WD	Approx. 17.7	Mixture of antifreeze and water (Ethylene-glycol with phosphate-based coolant for cooling device)
		4WD	Approx. 17.9	
	Extended type	2WD	Approx. 19.4	
		4WD	Approx. 19.6	

Vehicle Identification Number (VIN)

Type A



Type B



The Vehicle Identification Number (VIN) is the number used in registering your vehicle and in all legal matters pertaining to its ownership, etc.

- Type A: Engraved on the floor under the front left or right seat. Open the cover to check the VIN.
- Type B: Written on a plate attached to the top left or top right of the dashboard through the front windshield.

Vehicle certification label



The vehicle certification label attached on the center pillar as shown gives the vehicle identification number (VIN).

Tire specification and pressure label



The tire label located on the center pillar as shown gives the tire pressures recommended for your vehicle. The tires supplied on your new vehicle are chosen to provide the best performance for normal driving.

Motor number

2WD



4WD (if equipped)



The motor number is stamped on the motor as shown.

Air conditioner compressor label

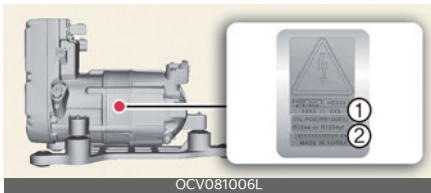

- 1 Refrigerant
- 2 Refrigerant oil

A compressor label informs you the type of compressor your vehicle is equipped with such as model, supplier part number, production number, refrigerant (1) and refrigerant oil (2).

Refrigerant label



The refrigerant label is located as shown.

Declaration of conformity

CE CE 0678

The radio frequency components of the vehicle comply with requirements and other relevant provisions of Directive 1995/5/EC.

Further information including the manufacturer's declaration of conformity is available on Kia website as follows:

<http://www.kia-hotline.com>

How to check the symbol on the charging label (For Europe) (if equipped)

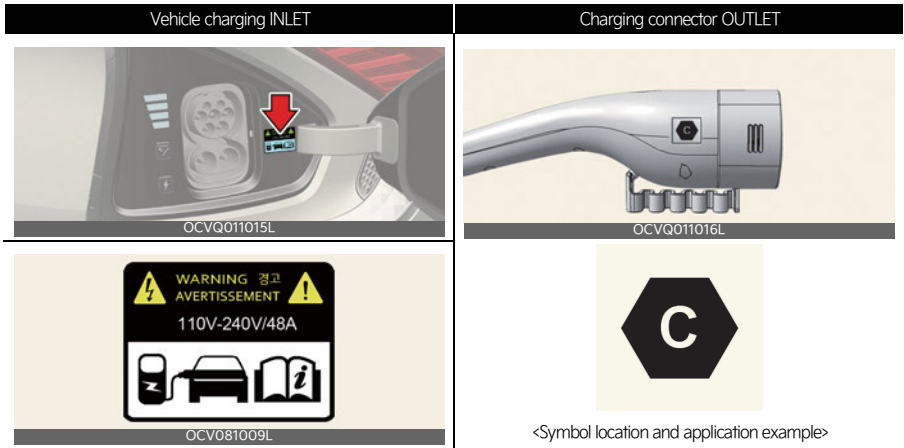

Precautions for charging AC and Trickle charger (Portable charging cable) (AC charging)

1. After opening the charging door, check the charging symbol at the bottom of the warning label.
2. Check the charging connector symbol of the AC and Trickle charger cable.
3. After checking the alphabet letter of the charging symbol, proceed the charging step.
 - * Refer to "Electric charging label symbol table (For Europe)" on page 9-8.
4. Risk of failure, fire, injury, etc. expected when using the charging connector with unmatched symbol.

Precautions for DC charging (DC charging)

1. After opening the charging door, check the charging symbol at the bottom of the warning label.
2. Check the charging connector symbol at the high speed charging station.
3. After checking the alphabet letter of the charging symbol, proceed the charging step.
 - * Refer to "Electric charging label symbol table (For Europe)" on page 9-8.
4. Risk of failure, fire, injury, etc. expected when using the charging connector with unmatched symbol.

Electric charging label (For Europe)

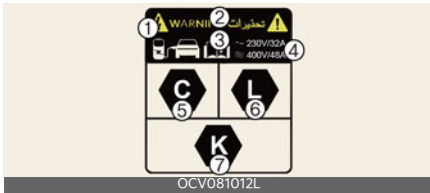

The electric charging label is attached on the charging door.

- 1. Warning for high voltage
- 2. Symbol for charging door

3. For further details, refer to "How to check the symbol on the charging label (For Europe) (if equipped)" on page 9-7.

- 4. Charging voltage and current
 (~): AC Single phase
 (≡): AC 3 phase

5~7: Symbols for charging type. For further details, refer to "Electric charging label symbol table (For Europe)" on page 9-8.

Electric charging label symbol table (For Europe)

AC and Trickle charger charging

Supply Type	Configuration	Type of Accessory	Voltage range	Identifier
AC	7P	Vehicle connector and vehicle inlet	≤ 480V RMS	

DC charging

Supply Type	Configuration	Type of Accessory	Voltage range	Identifier
DC	7P COMBO	Vehicle connector and vehicle inlet	50V to 500V	
			200V to 920V	

Abbreviation **A**

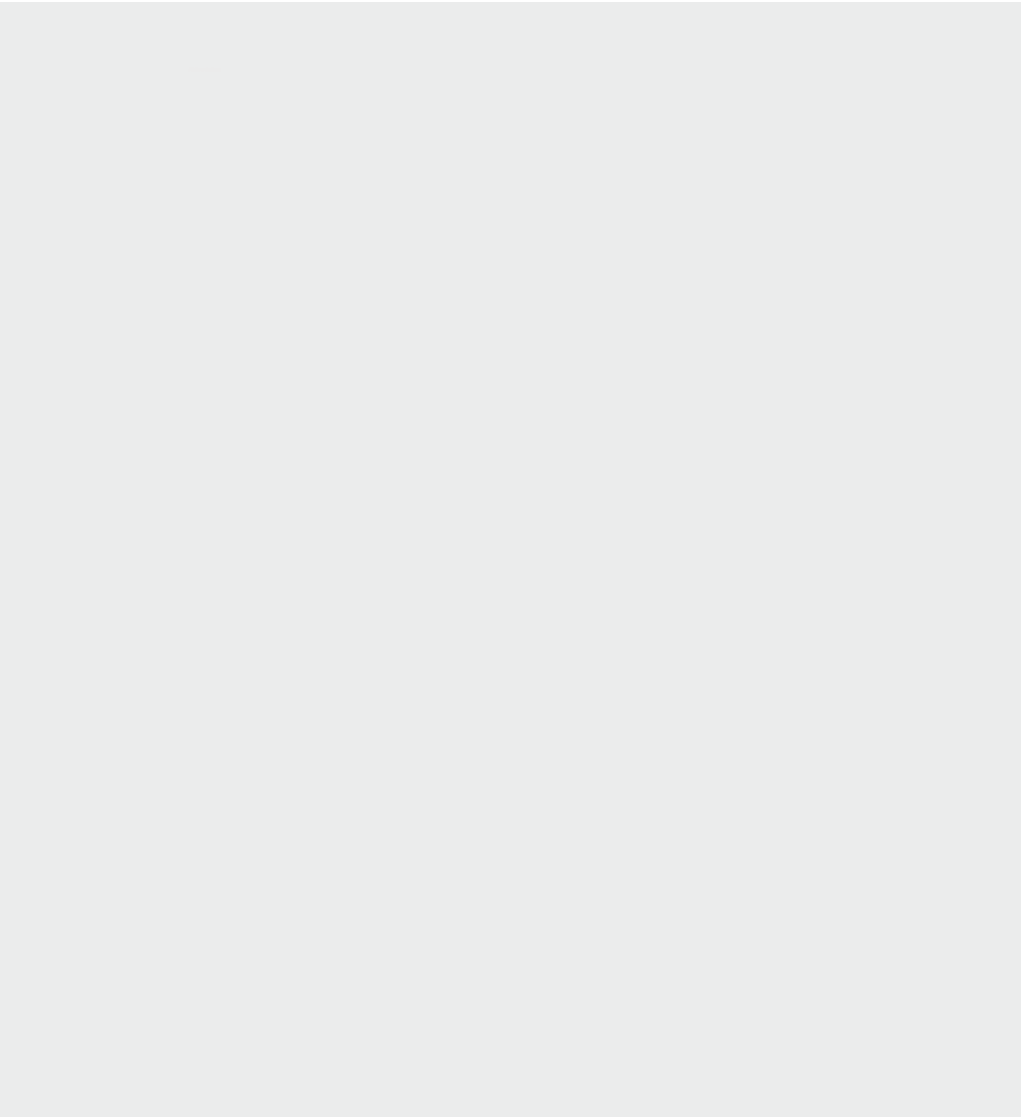

Abbreviation

ABS

Anti-lock Brake System

BAS

Brake Assistant System

BCA

Blind-Spot Collision-Avoidance Assist

BCW

Blind-Spot Collision Warning

BVM

Blind-Spot View Monitor

CC

Cruise Control

CRS

Child Restraint System

DAW

Driver Attention Warning

DRL

Daytime Running Light

EBD

Electronic Brake force Distribution

ECM

Electric Chromic Mirror

EPS

Electric Power Steering

ESC

Electronic Stability Control

ESS

Emergency Stop Signal

FCA

Forward Collision-Avoidance Assist

HAC

Hill-start Assist Control

HBA

High Beam Assist

HDA

Highway Driving Assist

HMSL

High Mounted Stop Lamp

HUD

Head-Up Display

ISLA

Intelligent Speed Limit Assist

LATCH

Lower Anchors and Tether for Children

LFA

Lane Following Assist

LKA

Lane Keeping Assist

MCB

Multi-Collision Brake

MDPS

Motor Driven Power Steering

MIL

Malfunction Indicator Lamp

MSLA

Manual Speed Limit Assist

Abbreviation

NSSC

Navigation-based Smart Cruise Control

PCA

Reverse Parking Collision-Avoidance Assist

PDW

Reverse Parking Distance Warning

RCCA

Rear Cross-Traffic Collision-Avoidance Assist

RCCW

Rear Cross-Traffic Collision Warning

RVM

Rear View Monitor

SBW

Shift-By-Wire

SCC

Smart Cruise Control

SEA

Safe Exit Assist

SEW

Safe Exit Warning

SRS

Supplemental Restraint System

SRSCM

SRS Control Module

SVM

Surround View Monitor

TBT

Turn By Turn

TCS

Traction Control System

TIN

Tire Identification Number

TPMS

Tire Pressure Monitoring System

VIN

Vehicle Identification Number

VSM

Vehicle Stability Management

Appendix **A**

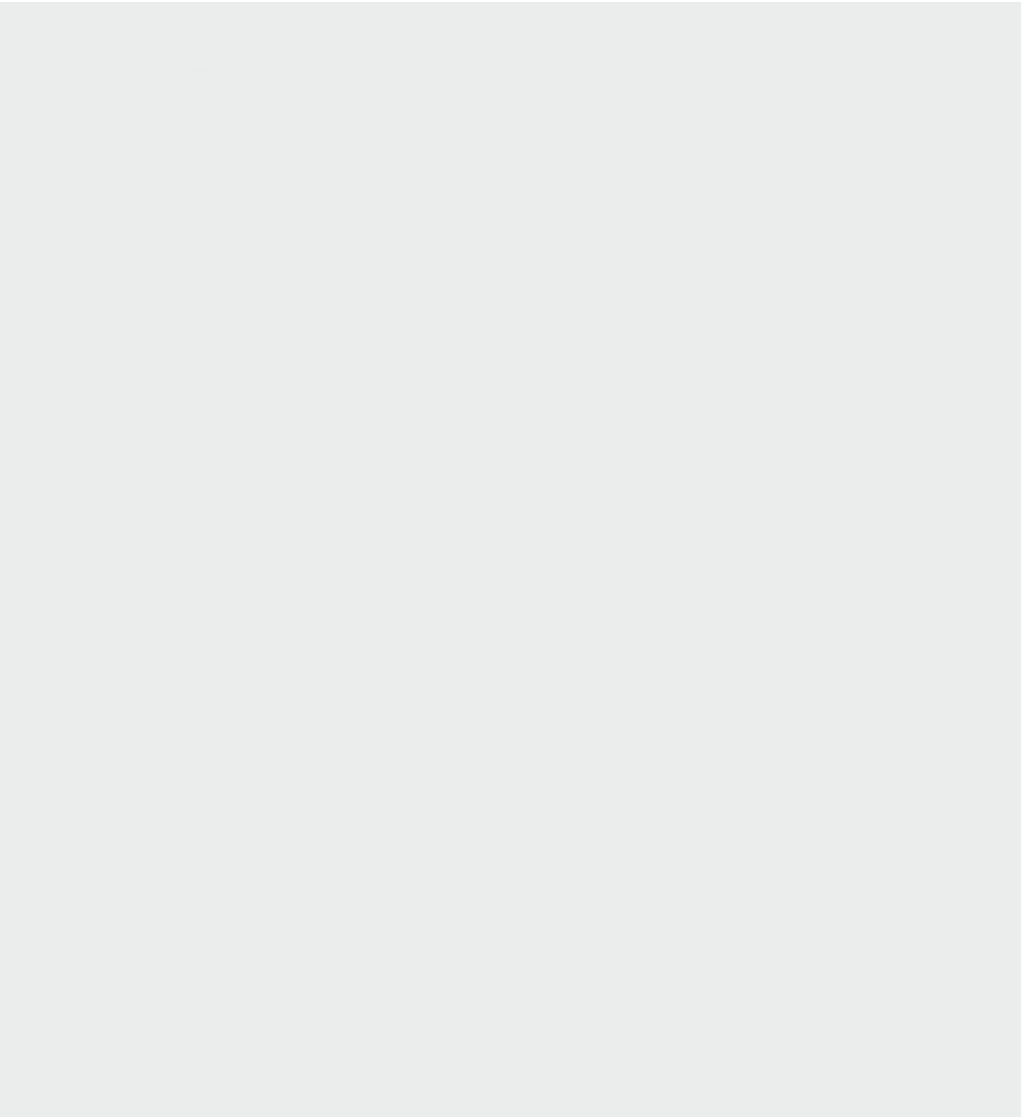

Appendix

Akstur að vetri til

Alvarlegar veðuraðstæður að vetri til leiða til meira slits og annarra vandamála.

Til að lágmarka vandamál í akstri að vetri til ættir þú að fylgja eftirfarandi uppástungum:

Aðstæður í snjó eða hálfu

Til að geta ekið ökutækinu þínu í djúpum snjó kann að vera nauðsynlegt að nota snjóhjólarða eða setja snjókeðjur á hjólin.

Ef þörf er á snjóhjólbörðum er nauðsynlegt að velja hjólarða sem eru jafngildir upprunalegu hjólbörðunum að stærð og tegund. Misbrestur á að gera svo kann að hafa óhagstæð áhrif á öryggi og aksturseginnleika ökutækisins þíns. Ennfremur kunna hraðakstur, snögg hröðun, skyndileg beiting hemla og krappar beygjur hugsanlega að reynast mjög hættuleg iðja.

Meðan á hraðaminnkun stendur skal nota hemla ökutækisins til hins ýtrasta. Skyndileg beiting hemla á snævi þöktum eða ísuðum vegum kann að valda því að bíllinn renni til. Þú þarft að halda nægilegri fjarlægð á milli ökutækisins þíns og ökutækisins fyrir framan þig. Beittu einnig hemlunum varlega. Athugaðu að uppsetning snjókeðja á hjólarðana mun veita meiri aksturskraft en kemur ekki í veg fyrir hliðarskrík.

Sumarhjólarðar (if equipped)

- Sumarhjólarðar eru notaðir til að hámarka akstursframmistöðu á þurrum vegum.
- Ef hitastigið er undir 7°C eða þú ekur á snævi þöktum eða ísuðum vegum

glata sumarhjólarðarnir hemlunarframmistöðu sinni og dragkrafti þar sem grip hjólarðanna minnkar umtalsvert.

- Ef hitastigið er undir 7°C eða þú ekur á snævi þöktum eða ísuðum vegum skaltu setja undir snjóhjólarða eða heilsárshjólarða af sömu stærð og staðlaða hjólarða ökutækisins þíns svo akstur verði öruggari. Bæði snjóhjólarðar og heilsárshjólarðar eru með M+S-merkingar.
- Þegar M+S-hjólarðar eru notaðir skal nota hjólarða með sama mynstri og framleidda af sama framleiðanda svo akstur verði öruggari.
- Þegar ekið er með M+S-hjólarða með lægri leyfilegan hámarkshraða en fyrir staðlaða sumarhjólarða ökutækisins, skal gæta þess að fara ekki umfram hraðann sem leyfður er fyrir M+S-hjólarðana.

Snjóhjólarðar

Ef þú setur snjóhjólarða undir ökutækið þitt skaltu ganga úr skugga um að þeir séu þverbandahjólarðar af sömu stærð og á sama álagssviði og upprunalegu hjólarðarnir. Settu snjóhjólarða á öll fjögur hjólin til að jafna út meðhöndlun ökutækisins við öll veðurskilyrði. Hafðu í huga að gripið sem snjóhjólarðar veita á þurrum vegum kann að vera minna en grip hjólarðanna sem upphaflega voru settir upp á ökutækinu. Þú ættir að aka varlega, jafnvel þegar vegurinn er auður. Athugaðu hjá hjólarðasalanum varðandi ráðleggingar um hámarkshraða.

Settu ekki upp neglða hjólarða án þess að athuga fyrst allar viðeigandi reglugerðir varðandi mögulega takmarkanir á notkun þeirra.

⚠ VÍÐVÖRUN

Snjóhjólbardar ættu að vera af jafngildri stærð og tegund og venjulegir hjólbardar ökutækisins. Að öðrum kosti kann það að hafa óhagstæð áhrif á akstureiginleika ökutækisins.

Keðjur á hjólbardða

Keðjur úr vír



Keðjur úr dúk



Vegna þess að hliðar þverbandahjólbardða eru þynnri kunna þeir að skemmast ef sumar tegundir af snjókeðjum eru festar við þá. Þar af leiðandi er mælt með notkun snjóhjólbardða í stað snjókeðja. Ekki skal setja keðjur á ökutæki sem búin eru álfelgum; snjókeðjur kunna að valda skemmdum á felgunum.

Skemmdir á ökutækinu þínu af völdum rangrar notkunar snjókeðja falla ekki undir ábyrgð framleiðandans.

Þegar þú notar snjókeðjur skaltu festa þær við drifhjólín sem hér segir.

- Á afturhjóladrifnum ökutækjum eru það afturhjólin sem gefa aflið. Því

verður að setja snjókeðjur á hjólbardðana að aftan.

- Á ökutækjum með aldrifi má aðeins setja snjókeðjur á hjólbardða að aftan. Við þær aðstæður skal lágmarka akstursvegalengd til að koma í veg fyrir skemmdir á aldrifskerfinu.
- Þegar keðjur hafa verið settar á skal aka hægt. Ef þú heyrir hljóð sem verður vegna þess að keðjurnar snerta yfirbygginguna skaltu hægja á þar til hljóðið hættir og fjarlægja keðjuna um leið og þú ferð að aka á hreinsuðum vegum til að koma í veg fyrir skemmdir.
- Keðjur af rangri stærð eða rangt settar upp kunna að skemma hemlaleiðslur ökutækisins, fjöðrun, yfirbyggingu og hjól. Þar af leiðandi skaltu fylgja leiðbeiningum framleiðandans þegar þú setur á snjókeðjur og festa þær eins þétt og mögulegt er. Aktu hægt, innan við 30 km/klst. (20 m/klst), með uppsettar keðjur.
- Settu upp keðjur á hjólbardðana sem standast tæknilyðingu hverrar hjólbardðastærðar til að koma í veg fyrir skemmdir á ökutækinu.
 - Bæði 19 og 20 tommu hjólbardðar nota snjókeðjur úr dúk.

⚠ VARÚÐ

- Gakktu úr skugga um að snjókeðjurnar séu af rétttri stærð og tegund fyrir hjólbardðana þína. Rangar snjókeðjur geta valdið skemmdum á yfirbyggingu ökutækisins og fjöðrun og ekki er víst að þær falli undir ábyrgð framleiðanda ökutækisins. Einnig geta tengikrókar snjókeðjanna skemmst vegna snertingar við ökutækið sem veldur því að snjókeðjurnar losna frá hjólbardðanum. Gakktu úr skugga um

að snjókeðjurnar séu í SAE-flokki og „S“-vottaðar.

- Athugaðu alltaf uppsetningu og rétta festingu keðja eftir að hafa ekið um það bil 0,5 til 1 km (0,3 til 0,6 mílur) til að tryggja örugga festingu. Hertu keðjurnar eða settu þær upp aftur ef þær eru lausar.
-

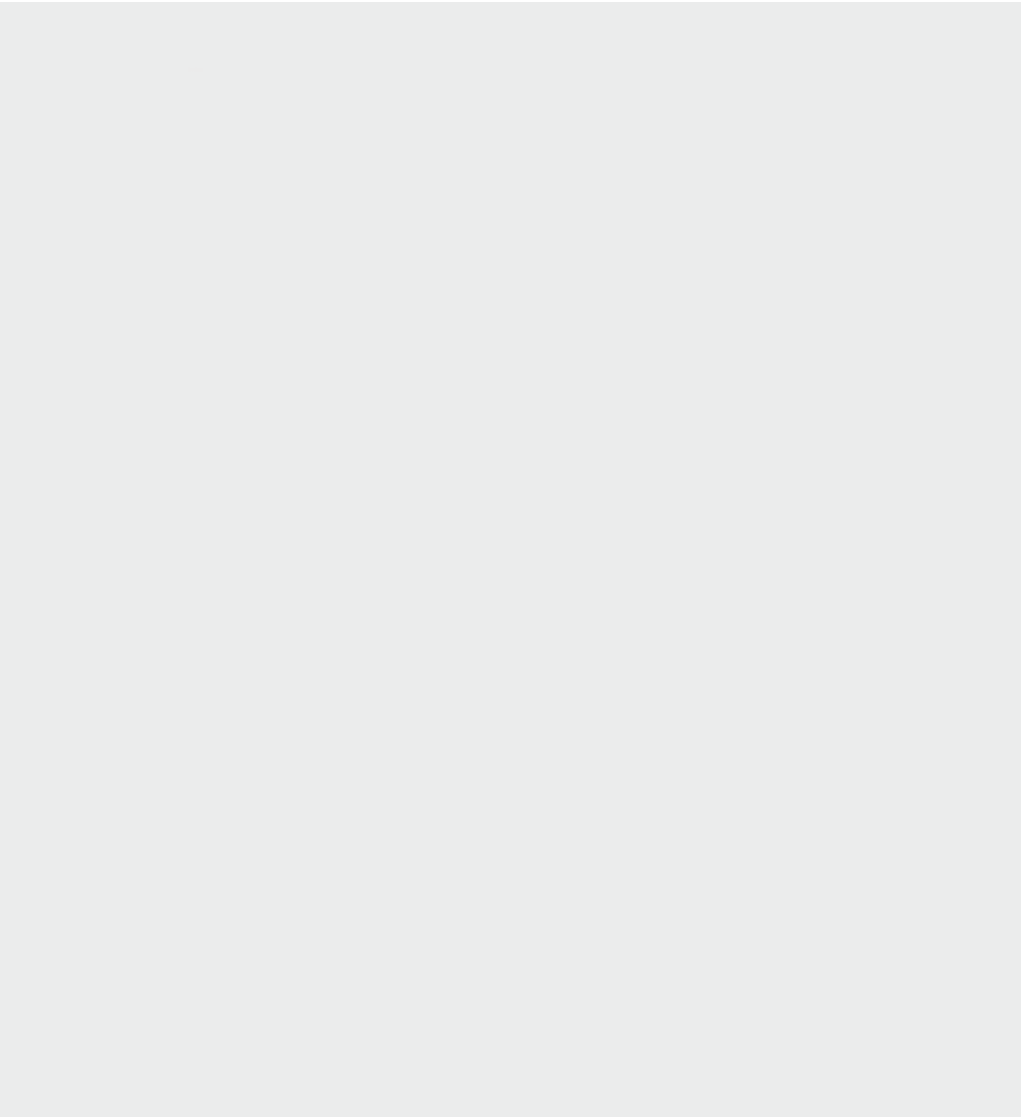

Index

A

AC charge 2-24
checking charging status 2-25
how to connect 2-24
how to disconnect 2-25
active air flap 6-37
malfunction 6-37
adjusting rear seatback angle 4-8
air bag 4-28
adding equipment to or modifying your air bag-equipped vehicle 4-45
additional safety precautions 4-45
air bag collision sensors 4-40
air bag inflation conditions 4-41
air bag non-inflation conditions 4-42
air bag warning labels 4-46
curtain air bag 4-38
driver's and passenger's front air bags 4-36
side air bag and front center air bag 4-37
SRS care 4-44
SRS components and functions 4-34
warning and indicator light 4-31
air bag collision sensors 4-40
air bag warning and indicator light
air bag warning light 4-31
air bag warning labels 4-46
all wheel drive (4WD) 6-34
emergency precautions 6-36
for safe 4WD operation 6-34
ambient lights 5-89
anti-lock brake system (ABS) 6-28
appearance care 8-40
exterior care 8-40
interior care 8-44
armrest 4-11
adjusting the armrest 4-11
carrying long/narrow cargo 4-11
audio system 5-96
sharkfin antenna 5-96
USB port 5-96
augmented reality HUD 5-58
head-up display information 5-58

head-up display settings 5-58
precautions 5-59
auto. controls that use climate control settings 5-85
auto defogging 5-83
AUTO HOLD 6-27
automatic climate control system 5-76
adjusting the driver and passenger side temperature to the same value 5-81
changing temperature scale 5-82
controlling automatically 5-81
controlling fan speed 5-82
controlling the temperature 5-81
operating 5-78
using the infotainment/climate switchable controller 5-77

B

battery 8-13
battery capacity label 8-14
battery recharging 8-14
for best battery service 8-13
reset items 8-15
battery saver function 5-60
before driving 6-6
good braking practices 6-7
good driving practices 6-6
necessary vehicle inspections 6-6
blind-spot collision-avoidance assist (BCA) 6-62
malfunction and limitations 6-68
operation 6-65
settings 6-64
blind-spot view monitor (BVM) 6-94
malfunction 6-95
operation 6-94
settings 6-94
brake assist system (BAS) 6-31
brake disc cleaning 6-22
brake fluid 8-9
checking the brake fluid level 8-9
brake system 6-22
AUTO HOLD 6-27
brake disc cleaning 6-22
in the event of brake failure 6-22

parking brake 6-23

C

cargo security screen 5-87

carrying long/narrow cargo 4-11

center console storage/glove box 5-86

charge indicator lamp for electric vehicle 2-19

charging status 2-19

charge types for electric vehicle 2-17

charging information 2-17

charging time information 2-17

charging types 2-18

charging and climate 2-8

off-peak time settings 2-9

target temperature settings 2-9

charging connector lock 2-19

locking charging cable 2-19

when the charging connector is locked 2-19

charging door 5-34

opening/closing the charging door 5-34

charging electric vehicle 2-21

electric charging door 2-21

charging the electric vehicle (abrupt stop) 2-35

child restraint system (CRS) 4-21

children always in the rear 4-21

installing a CRS 4-23

selecting a CRS 4-21

child-protector rear door lock 5-16

climate control air filter 8-11

replacing the climate control air filter 8-11

climate control system 5-73

coat hook 5-94

coolant 8-9

cruise control (CC) 6-95

operation 6-95

cup holders 5-89

curtain air bag 4-38

D

day/night rearview mirror 5-42

daytime running light (DRL) 5-61

DC charge 2-26

checking charging status 2-27

how to connect 2-26

how to disconnect 2-27

declaration of conformity 6-181

door locks 5-11

automatic door lock and unlock

features 5-14

deadlocks 5-15

inside the vehicle 5-13

manual door lock switch 5-15

outside the vehicle 5-11

rear door locks 5-16

rear occupant alert (ROA) 5-17

drive mode 6-32

drive mode integrated control system 6-32

drive mode 6-32

drive mode characteristics for 4WD 6-33

driver attention warning (DAW) 6-88

malfunction and limitations 6-92

operation 6-90

settings 6-89

driver position memory system 5-19

easy access function 5-19

recalling memory position 5-19

resetting 5-19

setting memory position 5-19

driver's and passenger's front

air bags 4-36

driver's side fuse panel 8-26

driving electric vehicle 2-36

distance to empty 2-37

ECO driving 2-38

energy consumption 2-38

LCD display messages 2-41

power/charge gauge 2-39

starting the vehicle 2-36

state of charge (SOC) gauge 2-39

stopping the vehicle 2-36

virtual engine sound system (VESS) 2-36

warning and indicator lights (related to electric vehicle) 2-40

E

electric chromic mirror (ECM) 5-42

electronic child safety lock system	5-16
electronic stability control (ESC)	6-28
emergency commodity	7-16
emergency starting	7-3
jump-starting (12V battery)	7-3
push-starting	7-4
emergency stop signal (ESS)	6-31
emergency while driving	7-2
flat tire while driving	7-2
vehicle stalls at a crossroad or crossing	7-2
vehicle stalls while driving	7-2
ev menu	2-6
charging and climate	2-8
ev mode screen	2-7
ev settings	2-14
nearby stations	2-14
next departure	2-8
vehicle to load (V2L)	2-9
ev settings	2-14
charging current	2-15
charging limit	2-14
utility mode	2-16
winter mode	2-15

F	
floor mat anchors	5-95
forward collision-avoidance assist (FCA)	6-38
malfunction and limitations	6-50
operation	6-43
settings	6-41
forward/reverse parking distance warning (PDW)	6-148
malfunction and precautions	6-151
operation	6-149
settings	6-149
front trunk	5-33
closing the front trunk	5-33
opening the front trunk	5-33
fuses	8-22
fuse/relay panel description	8-25
replacing inner panel fuse	8-23
replacing motor room fuse	8-24

G	
glove box lamp	5-72

H	
headlamp aiming (for europe)	8-36
headlamp escort function	5-61, 5-70
headlamp leveling adjustment	5-68
headrest	4-10
adjusting the headrest	4-10
removing/reinstalling the headrest	4-10
heated steering wheel	5-39
high beam assist (HBA)	5-63
highway driving assist (HDA)	6-120
malfunction and limitations	6-128
operation	6-122
settings	6-121
hill-start assist control (HAC)	6-29
hood	5-32
opening/closing the hood	5-32

I	
immobilizer system	5-8
infotainment system	5-95
audio system	5-96
using the infotainment/climate switchable controller	5-95
instrument cluster	5-45
intelligent front-lighting system (IFS)	5-66
intelligent speed limit assist (ISLA)	6-83
malfunction and limitations	6-86
operation	6-85
settings	6-84
interior features	5-89
ambient lights	5-89
coat hook	5-94
cup holders	5-89
floor mat anchors	5-95
power outlet	5-92
seat warmer/ventilation	5-89
sun visor	5-91
USB charger	5-91

wireless smartphone charging system	5-93
interior lights	5-71
automatic turn-off function	5-71
glove box lamp	5-72
luggage space lamp	5-72
map lamp	5-71
room lamp	5-72
vanity mirror lamp	5-72
interior rearview mirror	5-42
day/night rearview mirror	5-42
electric chromic mirror (ECM)	5-42
i-pedal	6-16
ISOFIX anchorage system for children	4-23
recommended CRS for vehicle	4-27
securing a CRS with a lap/shoulder belt	4-25
securing a CRS with the "ISOFIX anchorage system"	4-24
securing a CRS with the "top-tether anchorage system"	4-24
suitability of each seating position for belted & ISOFIX CRS	4-26

K

keys	5-6
locking/unlocking/remote starting/remote parking with the smart key	5-6
removing the mechanical key from the smart key	5-7
replacing the key battery	5-7

L

lamps	8-33
bulb replacement precautions	8-33
headlamp aiming (for europe)	8-36
light position (front)	8-34
light position (rear)	8-35
light position (side)	8-35
replacing glove box lamp (bulb type)	8-35
replacing lights (LED type)	8-35
lane following assist (LFA)	6-117
malfunction and limitations	6-120
operation	6-118
settings	6-118

lane keeping assist (LKA)	6-57
malfunction and limitations	6-60
operation	6-58
settings	6-57
LCD display	5-47
changing LCD display modes	5-47
LCD display messages	5-51
LCD display modes	5-47
LCD display modes	5-47
driver assistance settings (infotainment system)	5-50
driving assist mode	5-48
electric energy economy	5-48
information mode	5-49
master warning mode	5-49
service Interval	5-50
trip computer mode	5-48
turn by turn (TBT) mode	5-49
lighting	5-60
battery saver function	5-60
daytime running light (DRL)	5-61
headlamp escort function	5-61
headlamp leveling adjustment	5-68
high beam assist (HBA)	5-63
intelligent front-lighting system (IFS)	5-66
lighting controls	5-62
traffic change (for europe)	5-61
loading your vehicle - for australia	6-200
luggage net holder	5-87
luggage space lamp	5-72
luggage tray	5-87
lumbar support	4-5

M

main components of electric vehicle	2-4
high voltage battery warmer system	2-5
high voltage (HV) battery	2-4
maintenance services	8-4
owner maintenance precautions	8-4
owner's responsibility	8-4
manual speed limit assist (MSLA)	6-81
operation	6-81
map lamp	5-71

mirrors	5-42	adjusting power tailgate speed	5-23
interior rearview mirror	5-42	power tailgate automatic reversal	5-21
outside rear view mirror	5-42	resetting	5-24
motor compartment fuse panel	8-29	setting power tailgate	5-23
motor room compartment	8-3	precautions for charging electric vehicle	2-22
multi-collision brake (MCB)	6-29	unlock charging connector in emergency	2-22

N

navigation-based smart cruise control (NSCC)	6-112
limitations	6-114
operation	6-113
settings	6-112

O

one pedal driving	6-15
outside rear view mirror	5-42
adjusting	5-42
auto reverse function	5-43
folding	5-43
owner maintenance schedule	8-5

P

pan-european ecall system	7-17
description of the ecall in-vehicle system	7-17
information on data processing	7-18
parking brake	6-23, 6-24
electronic parking brake (EPB)	6-24
passenger's front air bag ON/OFF switch	4-32
portable charge	2-28
charging status indicator lamp for portable charger	2-32
checking charging status	2-31
how to connect	2-30
how to disconnect	2-34
precautions	2-34
setting the charge level	2-28
power button	6-8
power outlet	5-92
power tailgate	5-21
adjusting power tailgate opening height	5-24

R

rear cross-traffic collision-avoidance assist (RCCA)	6-137
malfunction and limitations	6-142
operation	6-139
settings	6-138
rear door locks	5-16
child-protector rear door lock	5-16
electronic child safety lock system	5-16
rear occupant alert (ROA)	5-17
rear view monitor (RVM)	6-130
malfunction and limitations	6-132
operation	6-131
settings	6-130
reduction gear	6-10
changing gear	6-10
LCD display messages	6-13
shift-lock system	6-11
regenerative braking system	6-15
adjusting with paddle shifter	6-15
i-pedal	6-16
one pedal driving	6-15
relaxion comfort seat	4-5
remote smart parking assist (RSPA)	6-159
malfunction and limitations	6-177
operation	6-162
settings	6-161
reverse parking collision-avoidance assist (PCA)	6-153
malfunction and limitations	6-155
operation	6-154
settings	6-153
reverse parking distance warning (PDW)	6-145
malfunction and precautions	6-147
operation	6-146

settings	6-145	settings	6-98, 6-102
review of electric vehicle	2-3	smart regeneration system	6-17
road warning	7-2	malfunction and limitations	6-18
hazard warning flasher	7-2	operating	6-17
room lamp	5-72	smart tailgate	5-24
<hr/>			
S		smart ventilation	5-86
safe exit assist (SEA)	6-76	special driving conditions	6-187
malfunction and limitations	6-79	specifications	
operation	6-78	air conditioner compressor label	9-6
settings	6-77	air conditioning system	9-3
safe exit warning (SEW)	6-72	available front trunk weight	9-3
malfunction and limitations	6-75	bulb wattage	9-3
operation	6-74	declaration of conformity	9-6
settings	6-73	dimensions	9-2
safety precautions for electric vehicle	2-46	electric vehicle specifications	9-2
scheduled charging	2-20	how to check the symbol on the charging label (for europe)	9-7
scheduled maintenance service	8-6	motor number	9-6
seat	4-3	recommended lubricants and capacities	9-4
adjusting the front seat	4-4	refrigerant label	9-6
adjusting the rear seat	4-8	tire specification and pressure label	9-5
infotainment system	4-4	tires and wheels	9-4
seatback pocket	4-6	vehicle certification label	9-5
seat belt pretensioner	4-16	vehicle identification number (VIN)	9-5
seat belt restraint system	4-13	volume and weight	9-2
3-point system with emergency locking retractor	4-15	starting the vehicle	6-8
seat belt pretensioner	4-16	power button	6-8
seat belt warning light	4-13	steering wheel	5-39
seat belt warning light	4-13	adjusting the angle and height	5-39
seat belts	4-12	heated steering wheel	5-39
care of seat belts	4-20	horn	5-40
precautions	4-18	storage compartment	5-86
seat belt restraint system	4-13	cargo security screen	5-87
seat warmer/ventilation	5-89	center console storage/glove box	5-86
seatback folding	4-8	luggage net holder	5-87
seatback pocket	4-6	luggage tray	5-87
selecting a CRS	4-21	sun visor	5-91
CRS types	4-22	surround view monitor (SVM)	6-133
sharkfin antenna	5-96	malfunction and limitations	6-136
side air bag and front center air bag	4-37	operation	6-135
smart cruise control (SCC)	6-98	settings	6-134
display and control	6-103	<hr/>	
malfunction and limitations	6-107	T	
		tailgate	5-20
		emergency safety release	5-27
		opening the smart tailgate	5-24

opening/closing the manual tailgate	5-20
opening/closing the power tailgate	5-21
tailgate emergency safety release	5-27
theft-alarm system	5-9
armed stage	5-9
disarmed stage	5-10
immobilizer system	5-8
theft-alarm stage	5-9
ultrasonic intrusion protection (UIP)	5-9
tire mobility kit	7-9
checking tire inflation pressure	7-12
components of the tire mobility kit	7-10
distributing the sealant	7-11
safe use of the tire mobility kit	7-13
using the tire mobility kit	7-11
tire pressure monitoring system (TPMS)	7-5
checking the tire pressure	7-5
malfunction indicator	7-7
when the telltale lights up	7-6
tires and wheels	8-15
checking tire inflation pressure	8-15
low aspect ratio tire	8-21
recommended cold tire inflation pressures	8-15
tire care	8-15
tire maintenance	8-18
tire replacement	8-17
tire rotation	8-17
tire sidewall labeling	8-19
tire traction	8-18
wheel alignment and tire balance	8-17
wheel replacement	8-18
towing	7-14
emergency towing	7-14
towing service	7-14
traffic change (for europe)	5-61
trailer towing	6-193
driving with a trailer	6-195
hitches	6-194
if you do decide to tow a trailer	6-198
maintenance when towing a trailer	6-197
safety chains	6-195
trailer brakes	6-195

U

ultrasonic intrusion protection (UIP)	5-9
unlock charging connector in emergency	2-22
USB charger	5-91
USB port	5-96
using the infotainment/climate switchable controller	5-95

V

vanity mirror lamp	5-72
vehicle identification number (VIN)	9-5
vehicle power	6-8
starting the vehicle	6-8
vehicle safety system	6-28
anti-lock brake system (ABS)	6-28
brake assist system (BAS)	6-31
electronic stability control (ESC)	6-28
emergency stop signal (ESS)	6-31
hill-start assist control (HAC)	6-29
multi-collision brake (MCB)	6-29
vehicle stability management (VSM)	6-30
vehicle settings (infotainment system)	5-53
vehicle stability management (VSM)	6-30
vehicle to load (V2L)	2-9
energy information	2-10
how to connect	2-10
LCD display messages	2-11
vehicle weight	6-199
base curb weight	6-199
cargo weight	6-199
GAW (gross axle weight)	6-199
GAWR (gross axle weight rating)	6-199
GVW (gross vehicle weight)	6-200
GVWR (gross vehicle weight rating)	6-200
loading your vehicle - for australia	6-200
overloading	6-200
vehicle curb weight	6-199
vehicle will not start	7-3
virtual engine sound system (VESS)	2-36

W

warning and indicator lights	5-54
washer fluid	8-10
checking the washer fluid level	8-10
welcome system	5-70
body silhouette lamp	5-70
headlamp escort function	5-70
interior lighting	5-71
wide sunroof	5-36
automatic reversal	5-37
power sunshade	5-36
resetting the sunroof	5-38
slide open/close	5-37
sunroof open warning	5-39
tilt open/close	5-37
windows	5-28
controlling windows switch	5-30
power windows automatic reversal	5-30
power windows lock button	5-30
remote window closing/opening	5-31
resetting	5-30
windshield defrosting and defogging	5-83
auto. controls that use climate control settings	5-85
auto defogging	5-83
defrosting/defogging the windshield	5-83
heat button	5-84
rear window/outside mirror defroster	5-84
smart ventilation	5-86
winter driving	6-190
wiper blade	8-12
replacing the front wiper blade	8-12
wipers and washers	5-68
washers	5-69
wipers	5-68
wireless smartphone charging system	5-93

