

CITROËN

C4

HANDBOOK



Download on the
App Store

GET IT ON
Google Play

Access to the Handbook



MOBILE APPLICATIONS

Install the **Scan MyCitröen** application (content available offline).

Also available in the **MyCitröen App** application.



ONLINE

View or download the handbook at the following address:

<http://service.citroen.com/ACddb/>



Scan this QR Code for direct access.

Select:

- the language,
- the vehicle and body style,
- the issue period of the handbook corresponding to the date of 1st registration of the vehicle.



This symbol indicates the latest information available.

Welcome

Thank you for choosing a Citroën C4 or a Citroën ë-C4.

This document contains the key information and recommendations you will need to be able to explore your vehicle in complete safety. We strongly recommend familiarising yourself with it, as well as the Maintenance and Warranty Guide.

Your vehicle will be fitted with only some of the equipment described in this document, depending on its trim level, version and the specification for the country in which it was sold.

The descriptions and illustrations are for guidance only.

Automobiles CITROËN reserves the right to modify the technical specifications, equipment and accessories without having to update this document.

If ownership of your vehicle is transferred, please ensure this **Handbook** is passed on to the new owner.

Key



Safety warning



Additional information



Environmental protection feature



Left-hand drive vehicle



Right-hand drive vehicle



Location of the equipment / button described using a black area.



	Overview				
		Heated steering wheel	42	Emergency or assistance	67
		Mirrors	43	Electronic stability control (ESC)	69
		Rear bench seat	44	Seat belts	71
	Eco-driving	Heating and Ventilation	45	Airbags	73
		Manual air conditioning	47	Child seats	75
		Dual-zone automatic air conditioning	47	Deactivating the front passenger airbag	77
	Instruments	Front demisting - defrosting	50	ISOFIX child seats	78
Driver information	9	Heated windshield	50	i-Size child seats	80
Instrument panels	9	Rear screen demisting/defrosting	51	Installing child seats	81
Head-up display	10	Temperature conditioning (Electric)	51	Child lock	83
Warning and indicator lamps	12	Interior fittings	52		
Indicators	18	Courtesy lamps	55	Driving	6
Manual test	22	Interior ambient lighting	55	Driving recommendations	84
Total distance recorder	23	Boot fittings	55	Starting / Switching off the engine with the key	86
Lighting dimmer	23			Starting/Switching off the engine with	
Trip computer	23	Lighting and visibility	4	Keyless Entry and Start	87
Touch screen BLUETOOTH audio system	24	Lighting control stalk	57	Manual parking brake	89
10-inch touch screen	25	Direction indicators	58	Electric parking brake	90
Remotely operable functions (Electric)	27	Automatic illumination of headlamps	59	6-speed manual gearbox	92
		Headlamp beam height adjustment	59	Automatic gearbox	92
		Guide-me-home and welcome lighting	59	Drive selector (Electric)	94
	Access	Automatic lighting systems - General recommendations	60	Driving modes	95
Electronic key with remote control function and built-in key	28	Automatic headlamp dipping	60	Hill start assist	96
Proximity Keyless Entry and Start	30	Cornering lighting	61	Gear shift indicator	97
Central locking	32	Wiper control stalk	62	Stop & Start	97
Back-up procedures	32	Intermittent wipers	63	Tyre under-inflation detection	99
Doors	35	Automatic wipers	63	ConnectedCAM Citroën	100
Boot	35	Changing a wiper blade	64	Driving and manoeuvring aids - General recommendations	101
Alarm	35			Road signs recognition	102
Electric windows	37			Speed limiter	105
Sunroof	38			Cruise control - Specific recommendations	107
				Cruise control	107
	Ease of use and comfort	Safety	5	Highway Driver Assist	109
Front seats	40	General safety recommendations	66	Adaptive cruise control	109
Steering wheel adjustment	42	Hazard warning lamps	66	Lane positioning assist	113
		Horn	67		
		Pedestrian horn (Electric)	67		

Active lane departure warning system	118
Blind spot monitoring	121
Active Safety Brake with Collision Risk Alert and Intelligent emergency braking assistance	122
Distraction detection	125
Parking sensors	126
Reversing camera	127
Top Rear Vision - 360 vision	128
Park Assist	132

7 Practical information

Compatibility of fuels	137
Refuelling	137
Misfuel prevention (Diesel)	138
Charging system (Electric)	138
Charging the traction battery (Electric)	145
Towing device	149
Towing device with quickly detachable towball	150
Roof bars	152
Snow chains	153
Energy economy mode	153
Bonnet	154
Engine compartment	155
Checking levels	156
Checks	158
AdBlue® (BlueHdi)	160
Free-wheeling	162
Advice on care and maintenance	162

8 In the event of a breakdown

Warning triangle	165
Running out of fuel (Diesel)	165
Tool kit	165
Temporary puncture repair kit	166
Spare wheel	169

Changing a bulb	171
Fuses	174
12 V battery / Accessory battery	175
Towing the vehicle	178

9 Technical data

Engine technical data and towed loads	181
Petrol engines	182
Diesel engines	183
Electric motor	184
Dimensions	185
Identification markings	185

10 Touch screen BLUETOOTH audio system

First steps	186
Steering mounted controls	186
Menus	187
Radio	188
DAB (Digital Audio Broadcasting) radio	189
Media	190
Telephone	191
Settings	193
Frequently asked questions	193

11 MyCitroën Play

First steps	196
Steering mounted controls	197
Menus	197
Radio	198
DAB (Digital Audio Broadcasting) radio	199
Media	200
Telephone	201
Applications	205
Settings	205

Frequently asked questions	206
----------------------------	-----

CITROËN Connect Nav 12

First steps	209
Steering mounted controls	210
Menus	210
Voice commands	212
Navigation	215
Connected navigation	218
Applications	220
Radio	223
DAB (Digital Audio Broadcasting) radio	224
Media	224
Telephone	226
Settings	228
Frequently asked questions	230

13 Event data recorders

Alphabetical index ■

Access to additional videos



 <http://q-r.to/bagGl9>

Presentation

These illustrations and descriptions are intended as a guide. The presence and location of certain elements may vary, depending on the version or trim level.

Instruments and controls

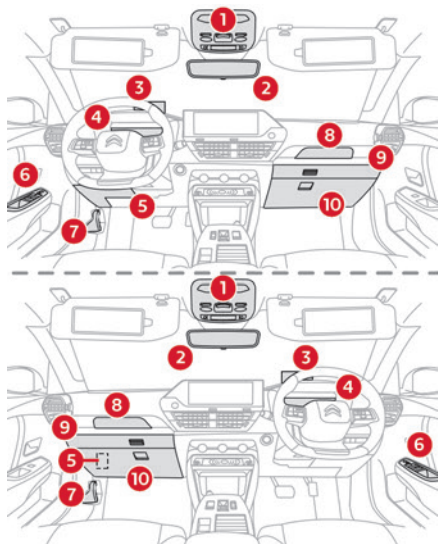

1. Courtesy lamp/Front reading lamps
Emergency and assistance call buttons
Sunroof
Warning lamps display for seat belts and front passenger airbag
2. Interior rear view mirror
3. Head-up display
4. Instrument panel
5. Fusebox
6. Electric windows
Electric door mirrors
7. Bonnet release
8. Smart Pad Support Citroën
9. Dashboard drawer
10. Glove box

2. Direct access to the **Driving** or **Vehicle** menu
Access to the touch screen menus
Touch screen on/off and volume control
3. Hazard warning lamps
4. Central locking
5. Switching the engine on/off
6. Air conditioning
Heated seats
7. USB sockets (type A/type C)
8. Storage compartment or Wireless smartphone charger
9. Gearbox or drive selector
10. Choice of driving mode
11. Access to the **Energy** menu
12. Electric parking brake

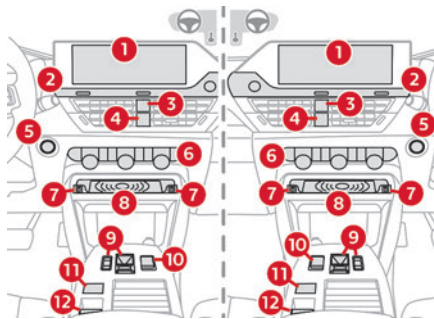

1. Touch screen BLUETOOTH audio system
or
10-inch touch screen with MyCitroën Play or CITROËN Connect Nav

Steering-mounted controls

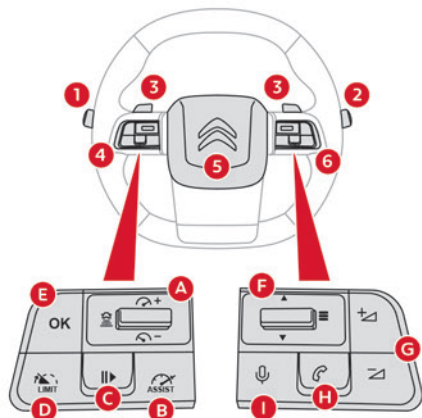

1. External lighting controls/Direction indicators / Select the instrument panel display mode
2. Wiper controls/Screenwash/Trip computer
3. Automatic gearbox control paddles
4. Controls for Cruise control/Speed limiter/ Adaptive cruise control
- A. Increase/Decrease the speed setting
Display and adjustment of the distance setting to the vehicle in front (Adaptive cruise control)
- B. Select/Deselect the cruise control function

- C. Start/Pause of the Speed limiter or Cruise control with the speed setting saved
Confirmation of vehicle restart after automatic stop (Adaptive cruise control with Stop & Go function)
- D. Select/Deselect the speed limiter function
- E. Activation of the Speed limiter or Cruise control with the speed setting saved
Use the speed suggested by the Road signs recognition system
5. Horn/Driver front airbag
6. Audio system controls
- F. Select previous/next media
- G. Decrease/Increase volume
- H. Access the **Telephone** menu
Manage calls
- I. Voice commands

Side controls

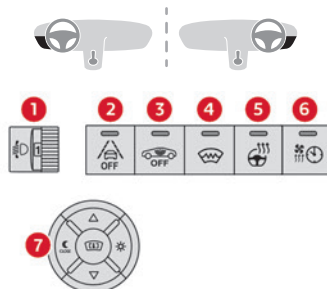

1. Headlamp beam height adjustment

2. Active lane departure warning system
3. Alarm
4. Heated windscreen
5. Heated steering wheel
6. Temperature conditioning
7. Head-up display controls

Electric motor

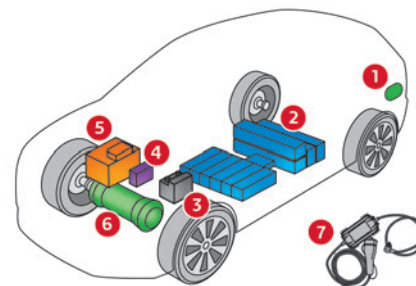

1. Charging connectors
2. Traction battery
3. Accessory battery
4. Heat pump
5. On-board charger
6. Electric motor
7. Charging cable

The charging connectors 1 enable 3 types of charging:

- Domestic charging in mode 2 using a domestic socket and associated charging cable

7.

- Accelerated charging in mode 3 using an accelerated charging unit (Wallbox).

- Superfast charging in mode 4 using a fast public charger.

The 400 V traction battery **2** uses Lithium-Ion technology. It stores and supplies the energy required for the operation of the electric motor, air conditioning and heating. Its charge level is represented by an indicator and a reserve power warning lamp on the instrument panel.

The 12 V accessory battery **3** powers the vehicle's conventional electrical system. It is recharged automatically by the traction battery via the on-board charger.

The heat pump **4** provides passenger compartment heating and regulates traction battery and on-board charger cooling.

The on-board charger **5** manages the domestic charging (mode 2) and accelerated charging (mode 3) of the traction battery as well as the recharging of the 12 V accessory battery.

The electric motor **6** provides propulsion in accordance with the selected driving mode and driving conditions. It recovers energy during vehicle braking and deceleration phases.

Eco-driving

Eco-driving refers to a range of everyday practices that allow the motorist to optimise the vehicle's energy consumption (fuel and/or electricity) and CO₂ emissions.

Optimise your use of the gearbox

With a manual gearbox, move off gently and change up promptly. While accelerating, change up early.

With an automatic gearbox, favour automatic mode. Do not depress the accelerator pedal heavily or suddenly.

The gear shift indicator prompts you to engage the most suitable gear. Whenever this indication is displayed on the instrument panel, follow it straight away.

With an automatic gearbox, this indicator appears only in manual mode.

Drive smoothly

Maintain a safe distance between vehicles, use engine braking rather than the brake pedal and press the accelerator gradually. These practices help to save on energy consumption, reduce CO₂ emissions and decrease general traffic noise.

When the traffic is flowing smoothly, select the cruise control.

Control the use of electrical equipment

Before moving off, if the passenger compartment is too warm, ventilate it by opening the windows and air vents before using the air conditioning.

At speeds above 31 mph (50 km/h), close the windows and leave the air vents open.

Consider using equipment that can help keep the temperature in the passenger compartment down (e.g. sunroof blind, window blinds).

Unless automatically regulated, switch off the air conditioning as soon as the desired temperature has been reached.

Switch off the demisting and defrosting functions, if they are not managed automatically.

Switch off the heated seat as soon as possible.

Adapt your use of the headlamps and/or foglamps to the level of visibility, in accordance with current legislation in the country in which you are driving.

Avoid running the engine before moving off, particularly in winter (other than in severe wintry conditions: temperature below -23°C). The vehicle will warm up much faster while driving.

As a passenger, avoid connecting your multimedia devices (e.g. film, music, video game) to help reduce the consumption of energy.

Disconnect all portable devices before leaving the vehicle.

Limit the causes of excess consumption

Spread loads throughout the vehicle. Place the heaviest items in the boot as close as possible to the rear seats.

Limit the loads carried in the vehicle and minimise wind resistance (e.g. roof bars, roof rack, bicycle carrier, trailer). Preferably, use a roof box.

Remove roof bars and roof racks after use.

At the end of winter, remove snow tyres and refit summer tyres.

Comply with the servicing instructions

Check tyre pressures regularly, with the tyres cold, referring to the label in the door aperture on the driver's side.

Carry out this check in particular:

- before a long journey.
- at each change of season.
- after a long period out of use.

Do not forget the spare wheel and, where applicable, the tyres on your trailer or caravan.

Have your vehicle serviced regularly (e.g. engine oil, oil filter, air filter, passenger compartment filter, etc.). Observe the schedule of operations in the manufacturer's service schedule.

With a BlueHDi Diesel engine, if the SCR system has a fault, your vehicle will emit pollution. Visit a CITROËN dealer or a qualified workshop as soon as possible to restore your vehicle's nitrogen oxide emissions to legal levels.

When filling the fuel tank, do not continue after the third cut-out of the nozzle, to avoid overflow.

You will only see the fuel consumption of your new vehicle settle down to a consistent average after the first 1,900 miles (3,000 kilometres).

Optimising the driving range (Electric)

The vehicle's electrical consumption depends heavily on the route, the vehicle speed and your driving style.

Try to remain in the "**ECO**" zone on the power indicator, by driving smoothly and maintaining a steady speed.

Anticipate the need to slow down, and brake smoothly, whenever possible using engine braking with the regenerative braking function, which will move the power indicator into the "**CHARGE**" zone.

Use the air conditioning rather than the heating to demist the passenger compartment.

Driver information

Instrument panel

The instrument panel displays all the information the driver needs about the status of the vehicle's various systems.

This information appears in the form of warning and indicator lamps and messages.

Depending on the vehicle's equipment, the instrument panel may be either:

- An LCD display.
- A fully digital display.

LCD instrument panel

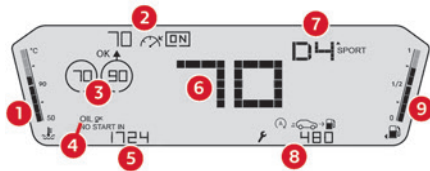

1. Coolant temperature indicator (°C)
2. Cruise control/speed limiter settings
3. Display of speed limit signs
4. Engine oil level indicator (depending on engine)
5. Total distance recorder (miles or km)
6. Digital speedometer (mph or km/h)

7. Selector position and gear on automatic gearbox
Gear shift indicator
Driving mode selected
8. Service indicator
Trip computer information
9. Fuel gauge

Digital instrument panel

The digital instrument panel can be personalised. Depending on the display mode selected, certain information is hidden or presented differently.

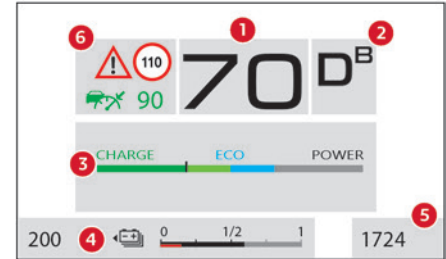
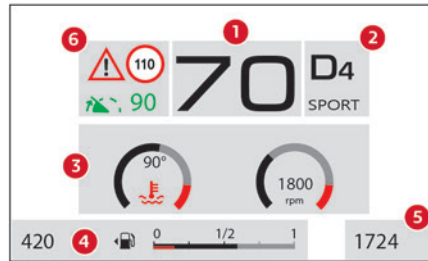

1. Digital speedometer (mph or km/h)
2. Selector position and gear on automatic gearbox (Petrol or Diesel)
Drive selector position (Electric)
Gear change indicator (Petrol or Diesel)
Driving mode selected
3. Personalisable area
For more information on the **Display modes**, please refer to the corresponding section.
4. Fuel gauge (Petrol or Diesel)
Charge level indicator (Electric)
Remaining range (miles or km)
5. Total distance recorder (miles or km)
6. Cruise control or speed limiter settings
Display of recognised signs
Indication of danger zones (with connected navigation)
For more information on **Connected navigation**, refer to the corresponding section.

Display modes

The available display modes vary depending on the vehicle's version and equipment.

The information displayed on the instrument panel (indicator/warning lamps, etc.) may have a fixed or variable location depending on the selected display mode.

For certain functions that have indicator lamps for both operation and deactivation, there is only one dedicated location.

Display language and units

These depend on the touch screen settings.

When travelling abroad, the speed must be shown in the official units of the country you are driving in (mph, miles or km/h, km).

Choosing the display mode

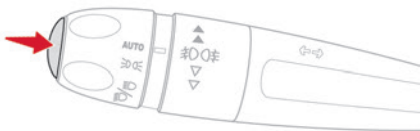

- ▶ Press the button located at the end of the lighting control stalk to scroll through the instrument panel display modes. The selected display mode is automatically applied after a few moments.

Contents of display modes

- **"Minimum"**: digital speedometer, selector position, driving range, distance recorder and:
 - Fuel gauge (Petrol or Diesel).
 - Battery charge indicator (Electric).
 - Power indicator (Electric).
- **"Dials"** (Petrol or Diesel): digital speedometer, selector position, driving range, distance recorder, fuel gauge, rev counter and engine coolant temperature indicator.
- **"Trip computer"** (Petrol or Diesel): digital speedometer, selector position, driving range, distance recorder, fuel gauge, current information and selected trip (1 or 2).
- **"Driving"**: digital speedometer, selector position, driving range, distance recorder, information about current driving aids and:
 - Fuel gauge (Petrol or Diesel).
 - Battery charge indicator (Electric).
- **"Navigation"**: digital speedometer, selector position, driving range, distance recorder, information about current navigation (map and settings) and:
 - Fuel gauge (Petrol or Diesel).
 - Battery charge indicator (Electric).
- **"Personal 1"/"Personal 2"** (Electric): digital speedometer, selector position, driving range, distance recorder, battery charge indicator and information selected by the driver.

Configuring a "Personal" display mode

With CITROËN Connect Nav

- ▶ Press **Settings** in the banner of the touch screen.
- ▶ Select **"OPTIONS"**.
- ▶ Select **"Instrument panel personalisation"**.
- ▶ Select **"Personal 1"** or **"Personal 2"**.
- ▶ Select the type of information using the scroll arrows:
 - **"Media"**.
 - **"Trip computer"**.
 - **"Flow"**.
 - **"Thermal Comfort Consumption"**.
- ▶ Confirm to save and exit.

The information is displayed immediately on the instrument panel if the corresponding display mode is selected.

The type of information selected in **"Personal 1"** mode is not available in **"Personal 2"** mode.

Head-up display

System which projects various information onto a transparent blade placed in the driver's field of vision to avoid the driver having to take their eyes off the road.

Display in operation

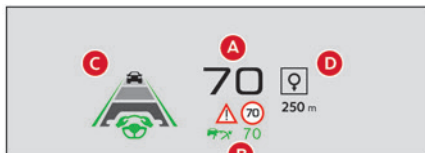

Once the system has been activated, the following information is grouped together in the head-up display:

- A. The speed of the vehicle.
- B. Cruise control/speed limiter information, indication of danger zones (with connected navigation) and, where fitted, information from the Road signs recognition function.
- C. If the vehicle is so equipped, inter-vehicle distance information, lane positioning assist information and automatic emergency braking alerts.
- D. If the vehicle is so equipped, navigation information.

i For more information about **Navigation**, refer to the sections describing the audio and telematics systems.

Selector

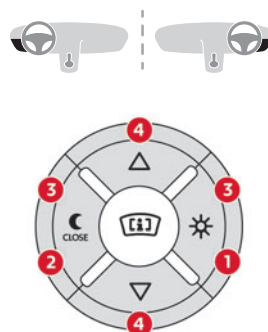

1. Switching on
2. Switching off (long press)
3. Brightness adjustment
4. Display height adjustment

Activation/Deactivation

- ▶ With the engine running, press any button to activate the system and deploy the projection blade.
- ▶ Press and hold button 2 to deactivate the system and retract the projection blade. The state of the system is saved when the engine is switched off and restored on restarting.

Adjusting the height

- ▶ With the engine running, adjust the display to the desired height using the buttons 4:

- up to move the display up,
- down to move the display down.

Brightness adjustment

- ▶ With the engine running, adjust the brightness of the information display using the buttons 3:

- on the "sun" to increase the brightness,
- on the "moon" to decrease the brightness.

! When stationary or while driving, no objects should be placed around the projection blade (or in its recess) so as not to impede its movement and correct operation.

i In certain extreme weather conditions (rain and/or snow, bright sunshine, etc.), the head-up display may not be legible or may suffer temporary interference. Some sunglasses may hamper reading of the information.

To clean the projection blade, use a clean, soft cloth (such as a spectacles cloth or microfibre cloth). Do not use a dry or abrasive cloth, or detergent or solvent products, due to the risk of scratching the projection blade or damaging the non-reflective coating.

Warning and indicator lamps

Displayed as symbols, the warning and indicator lamps inform the driver of the occurrence of a malfunction (warning lamps) or of the operating status of a system (operation or deactivation indicator lamps). Certain lamps light up in two ways (fixed or flashing) and/or in several colours.

Associated warnings

The illumination of a lamp may be accompanied by an audible signal and/or a message displayed in a screen.

Relating the type of alert to the operating status of the vehicle allows you to determine whether the situation is normal or whether a fault has occurred: refer to the description of each lamp for further information.

When the ignition is switched on

Certain red or orange warning lamps come on for a few seconds when the ignition is switched on. These warning lamps should go off as soon as the engine is started.

For more information on a system or a function, refer to the corresponding section.

Persistent warning lamp

If a red or orange warning lamp comes on, there may be a fault which needs further investigation.

If a lamp remains lit

The references (1), (2) and (3) in the warning and indicator lamp description indicate whether you should contact a qualified professional in addition to the immediate recommended actions.

(1): You must stop the vehicle.

Stop as soon as it is safe to do so and switch off the ignition.

(2): Contact a CITROËN dealer or a qualified workshop.

(3): Visit a CITROËN dealer or a qualified workshop.

List of warning and indicator lamps

Red warning/indicator lamps

STOP



Fixed, associated with another warning lamp, accompanied by the display of a message and an audible signal.

A serious fault with the engine, braking system, power steering or automatic gearbox or a major electrical fault has been detected.

Carry out (1) and then (2).

Engine self-diagnostic system (Petrol or Diesel)



Fixed.

A major engine fault has been detected.

Carry out (1) and then (2).

Maximum engine coolant temperature



Fixed.

The temperature of the cooling system is too high.

Carry out (1), then wait until the engine has cooled down before topping up the level, if necessary. If the problem persists, carry out (2).

Engine oil pressure (Petrol or Diesel)



Fixed.

There is a fault with the engine lubrication system.

Carry out (1) and then (2).

System malfunction (Electric)



Fixed.

A fault involving the electric motor or traction battery has been detected.

Carry out (1) and then (2).

Cable connected (Electric)



Fixed when the ignition is switched on.

The charging cable is connected to the vehicle's connector.



Fixed when the ignition is switched on, accompanied by a message.

It is not possible to start the vehicle while the charging cable is connected to the vehicle's connector.

Disconnect the charging cable and close the flap.

12V battery charge



Fixed.

The battery charging circuit is faulty (e.g. dirty terminals, loose or severed alternator belt).

Carry out (1).

If the electric parking brake stops working, immobilise the vehicle:

- ▶ With the manual gearbox, engage a gear.
- ▶ With the automatic gearbox or drive selector, fit the chock against one of the wheels.

Clean and tighten the terminals. If the warning lamp does not go off when the engine is started, carry out (2).

Braking



Fixed.

The brake fluid level in the braking circuit has dropped significantly.

Carry out (1), then top up with fluid that complies with the manufacturer's recommendations. If the problem persists, carry out (2).



Fixed.

The electronic brake force distribution (EBFD) system is faulty.

Carry out (1) and then (2).

Manual parking brake (depending on version)



Fixed.

The parking brake is applied or not properly released.



Fixed.

The parking brake is applied or not properly released.

Electric parking brake



Fixed.

The electric parking brake is applied.



Flashing.

Application/release is faulty.

Carry out (1): park on flat ground (on a level surface).

With a manual gearbox, engage a gear.

With an automatic gearbox or drive selector, select mode **P**.

Switch off the ignition and carry out (2).

Door(s) open



Fixed, associated with a message identifying the access.

An audible signal supplements the alert if the speed is higher than 6 mph (10 km/h).

A door or the boot is not properly closed.

Seat belts not fastened/unfastened



Fixed or flashing, accompanied by an increasing audible signal.

A seat belt has not been fastened or has been unfastened.

Orange warning/indicator lamps

Service



Temporarily on, accompanied by the display of a message.

One or more minor faults, for which there is/are no specific warning lamp(s), have been detected.

Identify the cause of the fault using the message displayed on the instrument panel.

You may be able to deal with some faults yourself, such as changing the battery in the remote control.

For other faults, such as with the tyre under-inflation detection system, carry out (3).



Fixed, accompanied by the display of a message.

One or more major faults, for which there is/are no specific warning lamp(s), have been detected. Identify the cause of the fault using the message displayed on the instrument panel, then carry out (3).



Fixed, accompanied by the message "**Parking brake fault**".

Automatic release of the electric parking brake is unavailable.

Carry out (2).



Service warning lamp fixed and service spanner flashing then fixed.

The servicing interval has been exceeded.

The vehicle must be serviced as soon as possible.

Only with BlueHDi Diesel engines.

Braking



Fixed.

A minor fault with the braking system has been detected.

Drive carefully.

Carry out (3).

Malfunction (with electric parking brake)

Fixed, accompanied by the message "Parking brake fault".

The vehicle cannot be immobilised with the engine running.

If manual application and release commands are not working, the electric parking brake control lever is faulty.

The automatic functions must be used at all times and are automatically re-enabled in the event of a control lever fault.

Carry out (2).



Fixed, accompanied by the message "Parking brake fault".

The parking brake is faulty: manual and automatic functions may not be working.

When stationary, to immobilise the vehicle:

► Pull and hold the control lever for approximately 7 to 15 seconds, until the indicator lamp comes on on the instrument panel.

If this procedure does not work, secure the vehicle:

- Park on a level surface.
- With a manual gearbox, engage a gear.
- With an automatic gearbox or drive selector, select **P**, then place the supplied chock against one of the wheels.

Then carry out (2).

Automatic functions deactivated (electric parking brake)

Fixed.

The "automatic application" (on switching off the engine) and "automatic release" (on acceleration) functions are deactivated.

If automatic application/release is no longer possible:

- Start the engine.
- Use the control to apply the electric parking brake.
- Take your foot fully off the brake pedal.
- Hold the control pressed in the release direction for between 10 and 15 seconds.
- Release the control.
- Depress and hold the brake pedal.
- Pull the control in the application direction for 2 seconds.
- Release the control and the brake pedal.

Anti-lock braking system (ABS)

Fixed.

The anti-lock braking system has a fault. The vehicle retains conventional braking.

Drive carefully at moderate speed, then carry out (3).

Power steering

Fixed.

The power steering has a fault.

Drive carefully at moderate speed, then carry out (3).

Engine self-diagnostic system (Petrol or Diesel)

Flashing.

The engine management system has a fault.

There is a risk that the catalytic converter will be destroyed.

You **must** carry out (2).



Fixed.

The emissions control system has a fault. The warning lamp should go off when the engine is started.

Carry out (3) without delay.



Fixed.

A minor engine fault has been detected.

Carry out (3).

Dynamic stability control (DSC)/Anti-slip regulation (ASR)

Flashing.

DSC/ASR regulation is activated in the event of a loss of grip or trajectory.



Fixed.

The DSC/ASR system has a fault.

Carry out (3).

Emergency brake malfunction (with electric parking brake)

Fixed, accompanied by the

message "**Parking brake fault**".

Emergency braking does not deliver optimal performance.

If automatic release is not available, use manual release or carry out (3).

Hill start assist



Fixed, accompanied by the message "Anti roll-back system fault".

The system has a fault.
Carry out (3).

Dynamic stability control (DSC)/Anti-slip regulation (ASR)



Fixed.
The system is deactivated.

The DSC/ASR system is reactivated automatically when the vehicle is restarted, and at speeds above approximately 31 mph (50 km/h).

At speeds below 31 mph (50 km/h), it can be reactivated manually.

Under-inflation



Fixed.
The pressure in one or more tyres is too low.

Check the pressure of the tyres as soon as possible.

Reinitialise the detection system after adjusting the pressure.



Under-inflation warning lamp flashing then fixed and Service warning lamp fixed.

The tyre pressure monitoring system is faulty.
Under-inflation detection is no longer monitored.

Check the tyre pressures as soon as possible and carry out (3).

Engine pre-heating (Diesel)



Temporarily on
(up to approximately 30 seconds in severe weather conditions).

When switching on the ignition, if the weather conditions and the engine temperature make it necessary.

Wait until the warning lamp goes off before starting.

When the warning lamp goes off, starting will occur immediately if you press and hold:

- the clutch pedal with a manual gearbox.
- the brake pedal with an automatic gearbox.

If the engine does not start, make the engine starting request again, while keeping your foot on the pedal.

Particle filter (Diesel)



Fixed, accompanied by an audible signal and a message about the risk of particle filter blockage.

The particle filter is nearing saturation.

As soon as traffic conditions permit, regenerate the filter by driving at a speed of at least 37 mph (60 km/h) until the warning lamp goes off.

Fuel filter (Diesel)



Fixed.
The Diesel fuel filter contains water.

Carry out (2) without delay. Risk of damaging the fuel injection system!

Airbags



Fixed.
One of the airbags or seat belt pyrotechnic pretensioners is faulty.
Carry out (3).

Front passenger airbag (ON)



Fixed.
The front passenger airbag is activated.
The control is in the "ON" position.

In this case, do NOT install a "rearward facing" child seat on the front passenger seat - risk of serious injury!

Front passenger airbag (OFF)



Fixed.
The front passenger airbag is deactivated.
The control is set to the "OFF" position.

A "rearward facing" child seat can be installed, unless there is a fault with the airbags (Airbags warning lamp on).

Low fuel level (Petrol or Diesel)



Fixed, with the reserve level shown in red, accompanied by an audible signal and the display of a message.

When it first comes on, you have **approximately 6 litres of fuel** remaining in the tank (reserve).
Until the fuel level is topped up, this alert will be repeated every time the ignition is switched on, with increasing frequency as the fuel level decreases and approaches zero.
Refuel without delay to avoid running out of fuel.

Never drive until completely empty, as this could damage the emissions control and injection systems.

Low traction battery level (Electric)



Fixed, accompanied by an audible signal.
The state of charge of the traction battery is low.

View the remaining range.

Put the vehicle on charge as soon as possible.

Tortoise mode with limited driving range (Electric)



Fixed.

The state of charge of the traction battery is critical.

The engine power gradually decreases.

You must put the vehicle on charge.

If the warning lamp remains lit, carry out (2).

Pedestrian horn (Electric)



Fixed.

Horn fault detected.

Carry out (3).

Collision Risk Alert/Active Safety Brake



Fixed, accompanied by the display of a message.

The system has been deactivated via the touch screen (**Driving/Vehicle** menu).



Flashing.

The system activates and brakes the vehicle momentarily to reduce the speed of collision with the vehicle in front.

For more information, refer to the **Driving** section.



Fixed, accompanied by a message and an audible signal.

The system has a fault.

Carry out (3).



Fixed.

The system has a fault.

If these warning lamps come on after the engine is switched off and then restarted, carry out (3).

Active lane departure warning system



Fixed.

The system has been automatically deactivated or placed on standby.



Flashing.

You are about to cross a broken lane marking without operating the direction indicators.

The system is activated, then corrects the trajectory on the side of the detected lane marking.

For more information, refer to the **Driving** section.



Fixed.

The system has a fault.

Carry out (3).

Lane positioning assist



Fixed, accompanied by the Service warning lamp.

The system has a fault.

Carry out (3).

Stop & Start (Petrol or Diesel)



Fixed, accompanied by the display of a message.

The Stop & Start system has been deactivated manually.

The engine will not switch off at the next traffic stop.



Fixed.

The Stop & Start system has been deactivated automatically.

The engine will not switch off at the next traffic stop, if the exterior temperature is:

- below 0°C.
- above +35°C.

For more information, refer to the **Driving** section.



Flashing then fixed, accompanied by a message.

The system has a fault.

Carry out (3).

AdBlue® (BlueHDi)



On for around 30 seconds when starting the vehicle, accompanied by a message indicating the driving range.

The driving range is between 1,500 and 500 miles (2,400 and 800 km).

Top up the AdBlue®.



Fixed, on switching on the ignition, accompanied by an audible signal and a message indicating the driving range.

The driving range is between 500 and 62 miles (800 and 100 km).

Promptly top up the AdBlue®, or carry out (3).

 Flashing, accompanied by an audible signal and a message indicating the driving range.

The driving range is less than 62 miles (100 km). You **must** top up the AdBlue® to **avoid engine starting being prevented**, or carry out (3).



 Flashing, accompanied by an audible signal and a message indicating that starting is prevented.

The AdBlue® tank is empty: the legally required engine immobiliser system prevents the engine from starting.

To restart the engine, top up the AdBlue® or carry out (2).



It is **essential** to add at least 5 litres of AdBlue® to the tank.

SCR emissions control system (BlueHDi)

  Fixed when the ignition is switched on, accompanied by an audible signal and a message.

A malfunction of the SCR emissions control system has been detected.



This alert disappears once the exhaust emissions return to normal levels.

  Flashing AdBlue® warning lamp on switching on the ignition, with the

Engine self-diagnostics warning lamp on fixed, accompanied by an audible signal and a message indicating the driving range.

Depending on the message displayed, it is possible to drive for up to 685 miles (1,100 km) before the engine immobiliser is triggered.

Carry out (3) without delay, to **avoid starting being prevented**.

  Flashing AdBlue® warning lamp on switching on the ignition, with the Engine self-diagnostics warning lamp on fixed, accompanied by an audible signal and a message indicating that starting is prevented. The engine immobiliser prevents the engine from restarting (the permitted driving limit has been exceeded after confirmation of a malfunction of the emissions control system).

To start the engine, carry out (2).

Rear foglamp

 Fixed.
The lamp is on.

Foot on the clutch (Petrol or Diesel)

 Fixed.
Stop & Start: the change to START mode is rejected because the clutch pedal is not fully depressed.

Fully depress the clutch pedal.

Foot on the brake

 Fixed.
Insufficient or no pressure on the brake pedal.

Automatic headlamp dipping

 Fixed, accompanied by an audible signal and a message.

A function or camera malfunction is detected.

Carry out (2).

Green warning/indicator lamps

Stop & Start (Petrol or Diesel)

 Fixed.
When the vehicle stops, the Stop & Start puts the engine into STOP mode.

 Flashing temporarily.
STOP mode is momentarily unavailable or START mode is automatically triggered.

For more information, refer to the **Driving** section.

Vehicle ready to drive (Electric)

 Fixed, accompanied by an audible signal when it comes on.

The vehicle is ready to drive and the thermal comfort systems are available.

The indicator lamp goes out upon reaching a speed of approximately 3 mph (5 km/h) and lights up again when the vehicle stops moving. The lamp will go out when you turn off the engine and exit the vehicle.

Park Assist

 Fixed.
The function is active.

For more information, refer to the **Driving** section.

Lane positioning assist

 Fixed.
The function has been activated.
All conditions have been met: the system is operating.

For more information, refer to the **Driving** section.

Direction indicators

Flashing with audible signal.

The direction indicators are on.

Sidelamps

Fixed.

The lamps are on.

Dipped beam headlamps

Fixed.

The lamps are on.

Automatic headlamp dipping

Fixed.

The function has been activated

via the touch screen (**Driving/Vehicle** menu).

The lighting control stalk is in the "AUTO" position.

For more information, refer to the **Lighting and visibility** section.

Front foglamps

Fixed.

The front foglamps are on.

Blue warning/indicator lamps

Fixed.

The lamps are on.

Black/white warning lamps**Foot on the clutch (Petrol or Diesel)**

Fixed.

Stop & Start: the change to START mode is rejected because the clutch pedal is not fully depressed.

Fully depress the clutch pedal.

Foot on the brake

Fixed.

Insufficient or no pressure on the brake pedal.

Fuel filter (Diesel)

Fixed.

The Diesel fuel filter contains water.

Carry out (2) without delay. Risk of damaging the fuel injection system!

Indicators

Service indicator

The servicing information is expressed in terms of distance (miles or kilometres) and time (months or days).

The alert is given at whichever of these two terms is reached first.

The servicing information is displayed in the instrument panel. Depending on the version of the vehicle:

- The distance recorder display line indicates the distance remaining before the next service is due, or the distance travelled since it was due preceded by the "-" sign.

- An alert message indicates the distance remaining, as well as the period before the next service is due or how long it is overdue.

i The value indicated is calculated according to the distance covered and the time elapsed since the last service. The alert may also be triggered close to a due date.

Service spanner

On temporarily when the ignition is switched on.

Between 620 and 1,860 miles (1,000 and 3,000 km) remain before the next service is due.



Fixed, when the ignition is switched on. The next service is due in less than 620 miles (1,000 km).

Have your vehicle serviced very soon.

Service spanner flashing

Flashing then fixed, when the ignition is switched on.

(With BlueHDi Diesel engines, associated with the Service warning lamp.)

The servicing interval has been exceeded.

Have your vehicle serviced as soon as possible.

Resetting the service indicator

The service indicator must be reset after each service.

If you have serviced your vehicle yourself:

- ▶ Switch the ignition off.

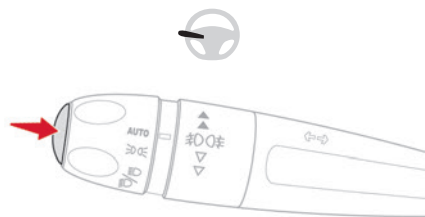

- ▶ Press and hold the button located on the end of the lighting control stalk.
- ▶ Switch on the ignition without starting the engine; a temporary display window appears and a countdown begins.
- ▶ When the display indicates =0, release the lighting control stalk button; the spanner symbol disappears.

i If you disconnect the battery following this operation, lock the vehicle and wait at least 5 minutes for the reset to be registered.

Reminder of the servicing information



You can view the servicing information by pressing the "Check" button in the **Driving/Vehicle** touch screen menu.

Engine oil level indicator

(Depending on version)

On versions fitted with an electric gauge, the engine oil level status is displayed on the

instrument panel for a few seconds when the ignition is switched on, after the servicing information.

i The level read will only be correct if the vehicle is on level ground and the engine has been off for more than 30 minutes.

Oil level correct

This is indicated by the display of **"OIL OK"** or by the message **"Oil level correct"** (depending on the instrument panel).

Low oil level

This is indicated by the display of **"OIL"** or by the message **"Oil level incorrect"** (depending on the instrument panel), accompanied by the lighting of the Service warning lamp and an audible signal.

If a low oil level is confirmed by a check using the dipstick, the level must be topped up to avoid damage to the engine.

For more information on **Checking levels**, refer to the corresponding section.

Oil gauge malfunction

This is indicated by the display of **"OIL_ _"** or by the message **"Oil level measurement invalid"** (depending on the instrument panel), accompanied by the lighting of the Service warning lamp and an audible signal.

Contact a CITROËN dealer or a qualified workshop.

! In the event of a malfunction of the electric gauge, the oil level is no longer monitored.

If the system is faulty, you must check the engine oil level using the manual dipstick located in the engine compartment. For more information on **Checking levels**, refer to the corresponding section.

Coolant temperature indicator

Depending on the type of instrument panel, this information is only available in the instrument panel's customisable area.

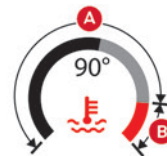

With the engine running:

- In zone **A**, the temperature is correct.
- In zone **B**, the temperature is too high.

The associated warning lamp and the **STOP** warning lamp light up in red on the instrument panel, accompanied by the display of a message and an audible signal.

You must stop the vehicle as soon as it is safe to do so.

Wait a few minutes before switching off the engine.

! After switching off the ignition, carefully open the bonnet and check the coolant level.

i For more information on **Checking levels**, refer to the corresponding section.

AdBlue® range indicators (BlueHDi)

The Diesel BlueHDi engines are equipped with a system that associates the SCR (Selective Catalytic Reduction) emissions control system and the Diesel particle filter (DPF) for the treatment of exhaust gases. They cannot function without AdBlue® fluid.

When the level of AdBlue® falls below the reserve level (between 1,500 and 0 miles (2,400 and 0 km)), a warning lamp lights up when the ignition is switched on and an estimate of the distance that can be travelled before engine starting is prevented is displayed in the instrument panel.

! The engine starting prevention system required by regulations is activated automatically once the AdBlue® tank is empty. It is then no longer possible to start the engine until the minimum level of AdBlue® has been topped up.

Manual display of driving range

While the driving range is greater than 1,500 miles (2,400 km), it is not displayed automatically.







You can view the range information by pressing the **"Check"** button in the **Driving/Vehicle** touch screen menu.

Actions required related to a lack of AdBlue®

The following warning lamps light up when the quantity of AdBlue® is below the reserve level: driving range of 1,500 miles (2,400 km). Together with the warning lamps, messages regularly remind you of the need to top up to avoid engine starting being prevented. Refer to the **Warning and indicator lamps** section for details of the messages displayed.

i For more information on **AdBlue® (BlueHDi)** and in particular on topping up, refer to the corresponding section.

Warning/indicator lamps on	Action	Remaining range
	Top up.	Between 1,500 miles and 500 miles (2,400 km and 800 km)
	Top up as soon as possible.	Between 500 miles and 62 miles (800 km and 100 km)
	A top-up is vital , there is a risk that the engine will be prevented from starting.	Between 62 miles and 0 miles (100 km and 0 km)
	To be able to restart the engine, add at least 5 litres of AdBlue® to the tank.	0 miles (km)

Malfunction of the SCR emissions control system

Malfunction detection

AdBlue



If a malfunction is detected, these warning lamps come on, accompanied by an audible signal and the display of an "**Emissions control fault**" message.

The alert is triggered while driving when the fault is detected for the first time, and thereafter when switching on the ignition for subsequent journeys, for as long as the cause of the fault persists.

If the fault is temporary, the alert disappears during the next journey, after self-diagnostic checks of the SCR emissions control system.

Malfunction confirmed during the permitted driving phase (between 685 miles and 0 miles (1,100 km and 0 km))

If the fault indication is still displayed permanently after 31 miles (50 km) of driving, the fault in the SCR system is confirmed. The AdBlue warning lamp flashes and a message is displayed ("**Emissions control fault: starting prevented in X miles (kms)**"), indicating the driving range in miles or kilometres.

While driving, the message is displayed every 30 seconds. The alert is repeated when switching on the ignition.

You can continue driving for up to 685 miles (1,100 km) before the **engine starting prevention** system is triggered.

! Have it checked by a CITROËN dealer or a qualified workshop.

Starting prevented

Every time the ignition is switched on, the message "**Emissions control fault: Starting prevented**" is displayed.

! **To restart the engine**
Contact a CITROËN dealer or a qualified workshop.

Power indicator (Electric)



CHARGE

Traction battery charging during deceleration and braking.

ECO

Moderate energy consumption and optimised driving range.

POWER

Energy consumption by the drive train during acceleration.

Charge level indicator (Electric)



The traction battery's actual charge level and the remaining range are displayed continuously when the vehicle is started.

i With the ignition off, opening the driver's door activates the indicator.

Associated warning lamps

Two successive alert levels indicate that the energy available has dropped to a low level:

1st level: Reserve



The state of charge of the traction battery is low.

Fixed, accompanied by an audible signal.

- View the remaining range on the instrument panel.
- Put the vehicle on charge as soon as possible.

2nd level: Critical



The state of charge of the traction battery is critical.

Fixed, together with the reserve warning lamp, accompanied by an audible signal.

- You must put the vehicle on charge.

! The remaining range is no longer calculated. The drive train power gradually decreases. The heating and air conditioning are switched off (even if the thermal comfort consumption indicator is not at the "ECO" level).

Flow indicator (Electric)

The flow indicator displays the energy flows in the vehicle in real time.

It is available in the "Personal 1"/"Personal 2" display modes of the instrument panel.

For more information on the **Display modes**, refer to the corresponding section.

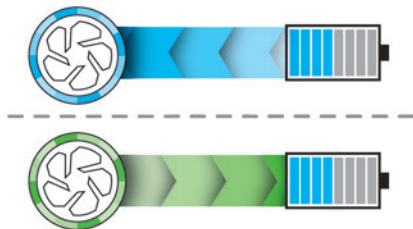

The indicator changes colour depending on how energy from the traction battery is being used:

Blue: energy consumption

Green: energy recovery

i This indicator does not represent the battery's actual level of charge.

Thermal comfort consumption indicator (Electric)

(Depending on version)

It is available in the "Personal 1"/"Personal 2" display modes of the instrument panel.

For more information on the **Display modes**, refer to the corresponding section.



The gauge shows the consumption of the traction battery's electrical energy by the thermal comfort devices in the passenger compartment. The devices in question are the heating and air conditioning systems.

This equipment can be used:

- If the vehicle is not plugged in, when the **READY** lamp is lit.
- If the vehicle is plugged in, when the ignition is switched on ("Lounge" mode).

Selecting **ECO** mode limits the performance of some of this equipment. The thermal comfort consumption indicator then moves into the "ECO" zone.

i To quickly heat or cool the passenger compartment, feel free to temporarily

select the maximum heating or cooling setting.

When the heating is on maximum, the gauge on the thermal comfort consumption indicator is in the **MAX** zone. When the air conditioning is on maximum, it stays in the **ECO** zone.

Excessive use of thermal comfort equipment, particularly at low speed, can significantly decrease the vehicle's range.

Remember to optimise equipment settings upon achieving the desired level of comfort, and adjust them if necessary whenever you start the vehicle.

After an extended period without using the heating, you may notice a slight odour during the first few minutes of use.

Manual test

This function allows you to check certain indicators and display the alerts log.



It can be accessed via the "**Check**" button in the **Driving/Vehicle** touch screen menu.

Depending on version, the following information is displayed on the instrument panel:

- Engine oil level.
- Next service due.
- Tyre pressures.
- Driving range associated with the AdBlue® and the SCR system (BlueHDi Diesel).
- Current alerts.

i This information is also displayed automatically every time the ignition is switched on.

Total distance recorder

The total distance recorder measures the total distance travelled by the vehicle since its initial registration.

With the ignition on, the total distance is displayed at all times. It remains displayed for 30 seconds after switching off the ignition. It is displayed when the driver's door is opened, and when the vehicle is locked or unlocked.

i When travelling abroad, you may have to change the distance units (km or miles): the road speed must be displayed in the local country's official unit (km/h or mph). The unit is changed via the screen configuration menu, with the vehicle stationary.



Lighting dimmer

This system allows the brightness of the instruments and controls to be adjusted manually to suit the ambient light level.

With BLUETOOTH touch screen audio system

 ▶ Press on the **Settings** menu.

 ▶ Select "**Display**".

  ▶ Adjust the brightness by pressing the buttons.



You can also switch off the screen:



 ▶ Select "**Turn off screen**".

The screen goes off completely.



▶ Press the screen again (anywhere on its surface) to activate it.

With MyCitroën Play



 /  ▶ Press **Settings** from the status bar or from the menu buttons.

 /  ▶ Select "**Brightness**" or "**Screen configuration**", depending on equipment.

 ▶ Adjust the instrument panel and screen brightness by using the arrows or moving the slider.

 /  ▶ Press this button to save and exit, depending on equipment.

You can also switch off the screen:

 /  ▶ Press **Settings** from the status bar or from the menu buttons.

 ▶ Select "**Turn off screen**" or "**Dark**", depending on equipment.

The screen goes off completely.

▶ Press the screen again (anywhere on its surface) to turn it on.

With CITROËN Connect Nav

With the lamps switched on:

 ▶ Press this button to select the **Settings** menu.

▶ Select "**OPTIONS**".

 ▶ Select "**Screen configuration**".

▶ Select the "**Brightness**" tab.

 ▶ Adjust the instrument panel and screen brightness by using the arrows or moving the slider.

 ▶ Press this button to save and exit.

You can also switch off the screen:

 ▶ Press this button to select the **Settings** menu.

 ▶ Select "**Turn off screen**".

The screen goes off completely.

▶ Press the screen again (anywhere on its surface) to turn it on.

Trip computer

Displays information related to the current trip (range, fuel consumption, average speed, etc.).

Data displayed on the instrument panel

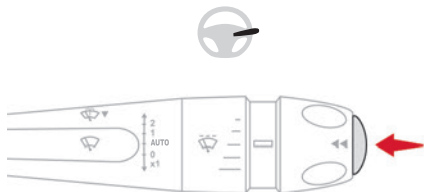

► Pressing the button located on the end of the wiper control stalk displays the following tabs in turn:

- Current information:
 - Driving range (Petrol or Diesel).
 - Current fuel consumption.
 - Stop & Start time counter (Petrol or Diesel).
- Trips "1" then "2":
 - Average speed.
 - Average fuel consumption.
 - Distance travelled.

Trip reset



► When the desired trip is displayed, press the button on the end of the wiper control stalk for more than 2 seconds. Trips "1" and "2" are independent and are used in the same way.

Definitions

Range

(miles or km)



Distance that can still be travelled with the fuel remaining in the tank (based on the average fuel consumption over the last few miles (kilometres) travelled).

This value may vary following a change in driving style or terrain, leading to a significant change in current fuel consumption.

When the range falls below 19 miles (30 km), dashes are displayed.

After filling with at least 5 litres of fuel, the range is recalculated and is displayed if it exceeds 62 miles (100 km).

Dashes appearing permanently in place of numbers while driving indicates a malfunction. Contact a CITROËN dealer or a qualified workshop.

Current consumption

(mpg or l/100 km or km/l)

(miles/kWh or kWh/100 km or km/kWh) (Electric)



Calculated during the last few seconds.

This function is only displayed at speeds above 19 mph (30 km/h) (Petrol or Diesel).

Average consumption

(mpg or l/100 km or km/l)

(miles/kWh or kWh/100 km or km/kWh) (Electric)



Calculated since the last trip computer reset.

Average speed

(mph or km/h)



Calculated since the last trip computer reset.

Distance travelled

(miles or km)



Calculated since the last trip computer reset.

Stop & Start time counter



(minutes/seconds or hours/minutes)

If your vehicle is fitted with the Stop & Start function, a time counter calculates the time spent in STOP mode during a journey.

The time counter is reset each time the ignition is switched on.

Touch screen BLUETOOTH audio system



This system gives access to the following elements:

- Audio system and telephone controls and display of related information.
- Vehicle function and equipment setting menus.





! For safety reasons, always stop the vehicle before performing operations that require sustained attention.

Some functions are not accessible while driving.

Recommendations





Do not use pointed objects on the touch screen.
Do not touch the touch screen with wet hands.
Use a soft, clean cloth to clean the touch screen.

Main controls

	With the ignition off: system start-up With the engine running: mute
	Volume adjustment
	Access to menus
	Return to the previous screen or confirm

i After a few moments with no action on the second page, the first page is displayed automatically.

Menus

	Radio
	Media
	Telephone
	Driving Activation, deactivation and settings for certain functions.
	Settings Main system settings.

i For more information about the menus, refer to the sections describing the audio and telematics systems.

10-inch touch screen

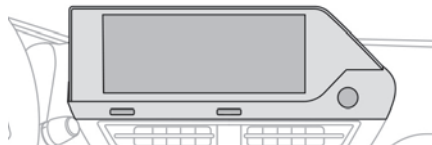

This system gives access to the following elements:

- Permanent display of the time and outside temperature (a blue warning lamp appears if there is a risk of ice).
- Heating/air conditioning system controls (depending on version).

- Vehicle functions and equipment setting menus.
- Audio system and telephone controls and display of related information.
- Display of visual manoeuvring aid functions (visual parking sensor information, Park Assist, etc.).
- Internet services and display of related information.
- Navigation system controls and display of related information (depending on version).

! For safety reasons, always stop the vehicle before performing operations that require sustained attention.

Some functions are not accessible while driving.

Recommendations

This screen is of the capacitive type.

- Do not use pointed objects on the touch screen.
- Do not touch the touch screen with wet hands.
- Use a soft, clean cloth to clean the touch screen.

Principles

 Use this button to access the menus, then press the buttons that appear on the touch screen.



Use this button for direct access to the **Driving/Vehicle** menu.

Some menus may display across two pages: press the **"OPTIONS"** button to access the second page.

After a few moments with no action on the second page, the first page is displayed automatically.

To deactivate/activate a function, select **"OFF"** or **"ON"**.



Configuring a function



Access to additional information on the function

OK

Confirm



Return to the previous page or confirm



Audio system on/off
Volume adjustment/mute

Menus

Press the touch screen with three fingers to show all of the menu buttons.

For more information about the menus, refer to the sections describing the audio and telematics systems.



Radio/Media



Climate

Settings for temperature, air flow, etc.

For more information on **Manual air conditioning** and **Dual-zone automatic air conditioning**, refer to the corresponding sections.



Navigation (Depending on equipment)



Driving or Vehicle (Depending on equipment)

Activation, deactivation and settings for certain functions.

The functions are organised in 2 tabs: **"Driving functions"** and **"Vehicle settings"**.



Telephone



Applications

Access to certain configurable equipment.



Settings

Main settings for the audio system, touch screen and digital instrument panel.

Information banner(s)

Certain information is displayed permanently in the touch screen banner(s).

- Outside temperature (a blue warning lamp appears if there is a risk of ice).
- Access to the **Settings** for the touch screen and the digital instrument panel (date/time, languages, units, etc.).
- Notifications.
- Reminder of the air conditioning information, and direct access to the corresponding menu.

– Time.

Energy menu (Electric)



It can be accessed directly by pressing the button located on the centre console.

The pages available vary depending on the audio equipment.

Flow

The page displays a real-time representation of the electric drive train's operation.

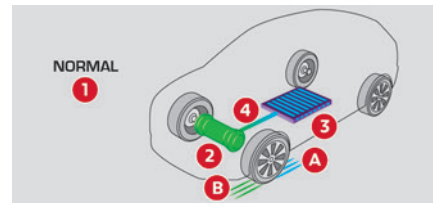

1. Active driving mode
2. Electric motor
3. Estimated traction battery charge level
4. Energy flows

The energy flows have a specific colour for each type of driving:

- A.** Blue: energy consumption
- B.** Green: energy recovery

Statistics

This page shows electrical energy consumption statistics.

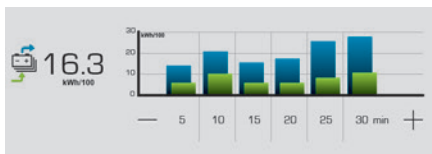

- Blue bar chart: directly consumed energy supplied by the traction battery.
- Green bar chart: energy recovered during deceleration and braking, used to recharge the battery.

The average result for the current trip is stated in kWh/100 km.

- ▶ You can change the displayed time scale by pressing the - or + buttons.

i A current trip is any trip of more than 20 minutes without switching off the ignition.

Charging

This page allows you to programme deferred charging.

For more information on **Charging the traction battery (Electric)**, refer to the corresponding section.

Remotely-operable functions (Electric)



The following functions are available from the **MyCitroën App** application, which is accessible from a smartphone:

- Managing the traction battery charging (deferred charging).
- Managing the temperature pre-conditioning.
- Viewing the state of charge and range of the vehicle.

Installation procedure

- ▶ Download the **MyCitroën App** app from the appropriate online store for your smartphone.
- ▶ Create an account.
- ▶ Enter the vehicle's VIN (code beginning with "VF" on the vehicle registration certificate).

For more information on **Identification markings**, refer to the corresponding section.

i Network coverage

In order to be able to use the various remotely operable features, ensure that your vehicle is located in an area covered by the mobile network.

A lack of network coverage may prevent communication with the vehicle (for example, if it is in an underground car park). In such cases, the application will display a message indicating that the connection with the vehicle could not be established.

Electronic key with remote control function and built-in key

Remote control function

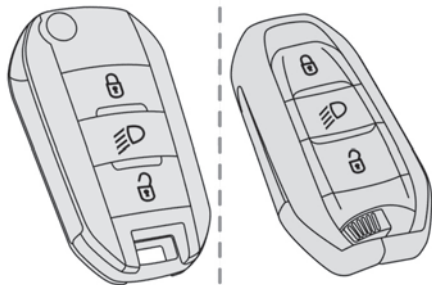

The remote control can be used for the following remote functions, depending on version:

- Unlocking/Locking/Deadlocking the vehicle.
 - Remote operation of lighting.
 - Folding/Unfolding the door mirrors.
 - Activating/Deactivating the alarm.
 - Locating the vehicle.
 - Opening/Closing the windows.
 - Closing the sunroof.
 - Activating the vehicle's electronic immobiliser.
- Back-up procedures allow the vehicle to be locked/unlocked in the event of a failure of the remote control, the central locking, the battery, etc. For more information on the **Back-up procedures**, refer to the corresponding section.

Built-in key

The key built into the remote control can be used for the following operations, depending on version:

- Locking/Unlocking the vehicle.
- Activation/Deactivation of the manual child lock.
- Activation/Deactivation of the front passenger airbag.
- Back-up Unlocking/Locking of the doors.
- Switching on the ignition and starting/switching off the engine.

Without Keyless Entry and Start

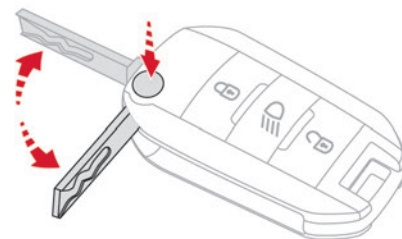

- ▶ To unfold or fold the key, press the button.

With Keyless Entry and Start

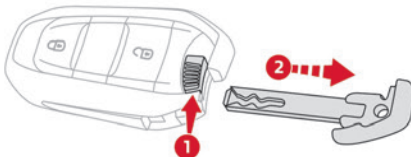

- ▶ To eject the key or put it back in place, pull and hold the button.

! Once the built-in key is ejected, always keep it with you to be able to carry out the corresponding back-up procedures.

Unlocking the vehicle



Selective unlocking is configured in the **Driving/Vehicle** touch screen menu.

Complete unlocking

- ▶ Press the unlocking button.

Selective unlocking

Driver's door and fuel filler/charging flap

- ▶ Press the unlocking button.
- ▶ Press it **again** to unlock the other doors and the boot.

The charging nozzle can be unplugged on the second press.

Complete or selective unlocking, and alarm deactivation (depending on version), is confirmed by the flashing of the direction indicators.

Depending on version, the door mirrors unfold.

Locking the vehicle



Normal locking

- ▶ Press the locking button.

The locking, and the activation of the alarm depending on version, is confirmed by the lighting of the direction indicators.

Depending on version, the door mirrors fold.

-  An access (door or boot) that is not properly closed prevents locking of the vehicle. However, if the vehicle is fitted with an alarm, it will be activated after 45 seconds. If the vehicle is unlocked but the doors or boot are not subsequently opened, the vehicle will automatically lock itself again after about 30 seconds. If the vehicle is fitted with an alarm, it will be reactivated automatically.

Deadlocking

-  Deadlocking renders the interior door controls inoperative. It also disables the central locking button.

The horn remains operational.

Never leave anyone inside the vehicle when it is deadlocked.

- ▶ Press the locking button.
- ▶ Press the locking button again within 3 seconds to deadlock the vehicle (confirmed by the temporary lighting of the direction indicators). For the vehicles equipped with the Proximity Keyless Entry and Start system, a double

audible signal indicates that the vehicle is not deadlocked.

Opening / Closing the windows

Opening the windows

-  ▶ Press the unlocking button for more than 3 seconds.

Depending on version, the windows stop when the button is released or by pressing the button a second time.

Closing the windows and sunroof (depending on version)

-  ▶ Press the locking button for more than 3 seconds.

Depending on version, the windows and the sunroof stop when the button is released or by pressing the button a second time.

-  Ensure that no person or object could prevent the correct closing of the windows and sunroof.

If, on versions with alarm, you want to leave the windows and/or sunroof partially open, you must first deactivate the interior volumetric alarm protection.

For more information on the **Alarm**, refer to the corresponding section.

Remote lighting of the lamps

-  ▶ Press this button. The sidelamps, dipped beam headlamps, number plate lamps and door mirror spotlamps come on for 30 seconds.

Pressing again before the end of the timed period switches off the lamps immediately.

Advice

Remote control

The remote control is a sensitive, high-frequency device; avoid handling it in your pocket, due to the risk of unintentionally unlocking the vehicle.

Avoid pressing the remote control buttons while out of range of the vehicle, due to the risk of rendering the remote control inoperative. It would then be necessary to reset it.

The remote control does not work when the key is in the ignition switch, even when the ignition is switched off.

Anti-theft protection

Do not modify the electronic vehicle immobiliser, as this might result in malfunctions.

For vehicles with a key ignition switch, remember to remove the key and turn the steering wheel to engage the steering lock.

! Locking the vehicle

Driving with the doors locked could make it more difficult for the emergency services to enter the passenger compartment in an emergency.

As a safety precaution, remove the key from the ignition or take the electronic key with you when leaving the vehicle, even for a short time.

i Purchasing a second-hand vehicle

Have the key codes memorised by a CITROËN dealer, to ensure that the keys in your possession are the only ones able to start the vehicle.

Proximity Keyless Entry and Start

This is a Keyless Entry and Start system. It enables automatic vehicle locking/unlocking simply by detecting the electronic key.

As long as the driver has the electronic key on their person, the vehicle unlocks as they approach and locks when they walk away. If the electronic key is present in an area between 2 and 7 m from the vehicle for more than 30 minutes, the system is deactivated to preserve the battery.

Key recognition zones:

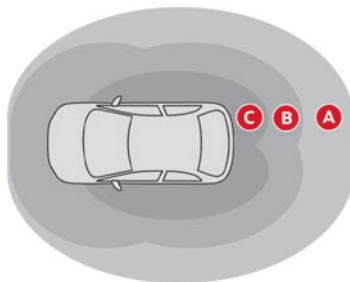

Zone A: welcome lighting on approaching the vehicle (between 3 and 5 metres from the vehicle).

Zone B: automatic locking on leaving the vehicle (about 2 metres from the vehicle).

Zone C: automatic unlocking on approaching the vehicle (between 1 and 2 metres from the vehicle).



The automatic functions are configured via the **Driving/Vehicle** touch screen menu.

Unlocking the vehicle

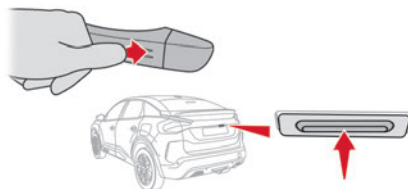

Selective unlocking is configured via the **Driving/Vehicle** touch screen menu. Selective unlocking is deactivated by default.

Complete unlocking

The vehicle (doors and boot) unlocks:

- ▶ Either automatically as the driver approaches in zone **C**, if the automatic functions are activated.
- ▶ Or by gently pressing the driver's door handle.

Unlocking, and alarm deactivation (depending on version), is confirmed by the flashing of the direction indicators.

Depending on version, the door mirrors unfold.



If the electronic key remains around the vehicle (zones **A**, **B** or **C**) for more than 15 minutes without action, the automatic functions are deactivated. To unlock or lock the vehicle, use the remote control or press the driver's door handle.

If using the door handle does not lock/unlock the vehicle, bring the electronic key closer and repeat the desired action.

Selective unlocking

Driver's door and fuel/charging flap

They unlock:

- ▶ Either automatically when approaching the driver's door, if the automatic functions are activated.

- ▶ Or by gently pressing the driver's door handle.
- ▶ Once inside the vehicle, to unlock all accesses, press the central locking button or pull the opening control on any door.

Locking the vehicle

Normal locking

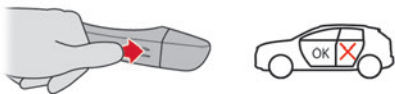

With the doors and boot closed, the vehicle locks:

- ▶ Either automatically, upon leaving zone **B**, if the automatic functions are activated.
- ▶ Or by gently pressing the driver's door handle.

Locking is confirmed by the lighting of the direction indicators, and by a double audible signal when the vehicle is locked upon walking away.

! The alarm does not activate when locking automatically from a distance (the direction indicators do not light up).

It is not possible to lock the vehicle if the electronic key is left inside the vehicle.

Deadlocking

! Deadlocking renders the interior door controls inoperative. It also deactivates the central locking button. The horn remains operational. **Never leave anyone inside the vehicle when it is deadlocked.**

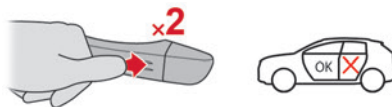

- ▶ Gently press the driver's door handle to lock the vehicle.
- ▶ Press it again within 3 seconds to deadlock the vehicle (confirmed by the temporary lighting of the direction indicators). A double audible signal indicates that the vehicle is not deadlocked.

Advice

i If one of the doors or the boot is still open or if the electronic key for the Keyless Entry and Start system has been left inside the vehicle, central locking will not take place.

i If the vehicle is unlocked but the doors or boot are not subsequently opened, the vehicle will automatically lock itself again after about 30 seconds. If the vehicle is fitted with an alarm, it will be reactivated automatically.

i The automatic door mirror folding/unfolding function is configured via the touch screen's **Driving/Vehicle** menu.

! As a safety measure, never leave the vehicle, even for a short time, without taking the Keyless Entry and Start system's electronic key with you. Be aware of the risk of theft of the vehicle if the key is present in one of the defined areas while the vehicle is unlocked.

! In order to preserve the battery in the electronic key and the vehicle's battery:

- The unlocking on approach function (zone **C**) automatically switches to hibernation mode after several days (approximately one week) without being used. To unlock the vehicle, use the remote control or press on one of the door handles. The next time the vehicle is started, the automatic unlocking and locking functions will be reactivated.
- If the welcome lighting is triggered several times in succession without the vehicle subsequently being started, it will be deactivated.
- All "hands-free" functions switch to hibernation mode after 21 days without being used. To restore these functions, unlock the vehicle using the remote control and start the engine.

i Electrical interference

The electronic key may not work if it is close to an electronic device (e.g. mobile telephone (switched on or on standby), laptop computer, strong magnetic fields). If this occurs, move the electronic key away from the electronic device.

Central locking



Manual

► Press this button to lock/unlock the vehicle (doors and boot) from inside the passenger compartment.

! Central locking does not take place if any of the doors are open.

i When locking/deadlocking from the outside

When the vehicle is locked or deadlocked from the outside, the indicator lamp flashes and the button is deactivated.

- After normal locking, pull one of the interior door controls to unlock the vehicle.
- After deadlocking, you must use the remote control or the Keyless Entry and Start system to unlock the vehicle.

Automatic (anti-intrusion security)

The doors and boot lock automatically while driving (speed above 6 mph (10 km/h)). To deactivate/reactivate this function (activated by default):

- Press the button until a confirmation message appears.

i Transporting long or voluminous objects

Press the central locking control to drive with the boot open and the doors locked. Otherwise, every time the speed of the vehicle exceeds 6 mph (10 km/h), the sound of the locks rebounding will be heard and an alert will be displayed.

Back-up procedures

Lost keys, remote control, electronic key

Go to a CITROËN dealer with the vehicle's registration certificate, your personal

identification documents and if possible, the label bearing the key code.

The CITROËN dealer will be able to retrieve the key code and the transponder code, enabling a new key to be ordered.

Complete unlocking/locking of the vehicle with the key

Use this procedure in the following situations:

- Remote control battery discharged.
- Remote control malfunction.
- Vehicle battery discharged.
- Vehicle in an area subject to strong electromagnetic interference.

In the first case, change the remote control battery.

In the second case, reinitialise the remote control.

Refer to the corresponding sections.

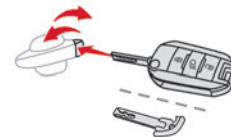

- Insert the key in the door lock.
- Turn the key towards the front or the rear to unlock or lock the vehicle.

i If the vehicle is fitted with an alarm, it will not be activated when locking with the key. If the alarm is activated, the siren sounds when the door is opened; switch on the ignition to stop it.

Central locking not functioning

Use these procedures in the following cases:

- Central locking malfunction.
- Battery disconnected or discharged.

! In the event of a malfunction of the central locking system, the battery must be disconnected to ensure that the vehicle is locked fully.

Front left-hand door

▶ Insert the key into the lock and turn it towards the front or rear of the vehicle to lock and unlock the door.

Other doors

Unlocking

▶ Pull the interior door opening control.

Locking

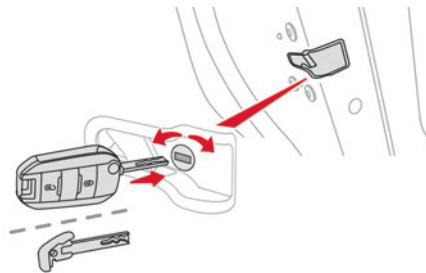

- ▶ Open the doors.
- ▶ For the rear doors, check that the child lock is not on.

Refer to the corresponding section.

▶ Gently insert the key into the latch located in the door lock, then turn the latch an eighth of a turn towards the outside of the door.

▶ Close the doors and check from the outside that the vehicle is locked.

Changing the battery

 If the battery is flat, this warning lamp comes on, accompanied by an audible signal and the display of a message.

Battery type: CR2032/3 volts.

Without Keyless Entry and Start

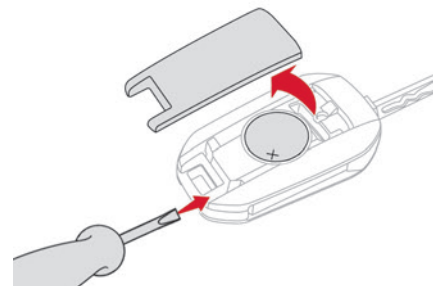

With Keyless Entry and Start

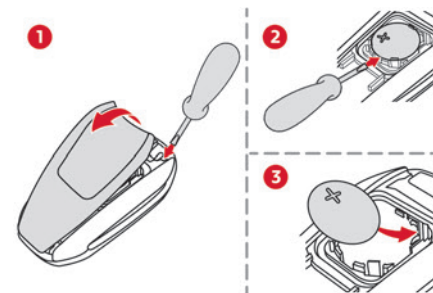

- ▶ Unclip the cover by inserting a small screwdriver in the slot and lift the cover.
- ▶ Remove the flat battery from its housing.
- ▶ Put the new battery in place, respecting the polarity. Start by inserting it into the contacts

located in the corner, then clip the cover onto the unit.

- ▶ Reinitialise the remote control.

For more information on **Reinitialising the remote control**, refer to the corresponding section.



Do not throw remote control batteries away, as they contain metals that are harmful to the environment. Take them to an approved disposal point.



This equipment contains a button type battery.

Do not swallow the battery. Risk of chemical burns!

Swallowing the battery can cause serious internal burning in only 2 hours and can be fatal.

If batteries have been swallowed or inserted into a part of the body, seek immediate medical advice.

Keep new and used batteries out of the reach of children.

If the battery compartment does not close properly, stop using the product and keep it out of the reach of children.



Risk of explosion if the battery is replaced with an incorrect type!

Replace the battery with the same type.

! Risk of explosion or leaking of inflammable liquid or gas!

Do not use in/store in/place in an environment where the temperature is extremely high or where the pressure is extremely low due to very high altitude.

Do not try to burn, crush or cut a used battery.

Reinitialising the remote control

Following replacement of the battery or in the event of a fault, it may be necessary to reinitialise the remote control.

To reinitialise the remote control, visit a CITROËN dealer or a qualified workshop.

Without Keyless Entry and Start

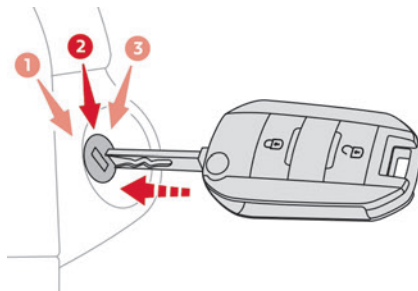

- ▶ Switch the ignition off.
- ▶ Turn the key to position **2 (Ignition on)**.

- ▶ Immediately press the closed padlock button for a few seconds.

- ▶ Switch off the ignition and remove the key from the ignition switch.

The remote control is now fully operational again.

With Keyless Entry and Start

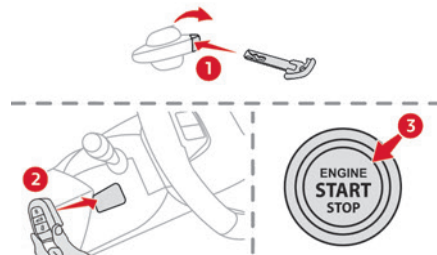

- ▶ Insert the mechanical key (incorporated into the remote control) into the lock to open the vehicle.
- ▶ Place the electronic key against the back-up reader on the steering column and hold it there until the ignition is switched on.
- ▶ **With a manual gearbox**, place the gear lever in neutral then fully depress the clutch pedal.
- ▶ **With an automatic gearbox or drive selector**, while in mode **P**, depress the brake pedal.
- ▶ Switch on the ignition by pressing the **"START/STOP"** button.

If the fault persists after reinitialisation, contact a CITROËN dealer or a qualified workshop without delay.

Doors

Opening

From outside

► After unlocking the vehicle or with the "Keyless Entry and Start" system electronic key in the recognition zone, pull the door handle.

From inside

► Pull the interior opening control of a door; this unlocks the vehicle completely.

- i** With selective unlocking activated:
 - Opening the driver's door unlocks the driver's door only (if the vehicle has not already been completely unlocked).
 - Opening one of the passenger doors unlocks the rest of the vehicle.

Closing

 If a door is not properly closed, this warning lamp comes on accompanied by a message if the engine is running, and an audible signal when the vehicle is travelling at more than 6 mph (10 km/h).

Boot

Opening

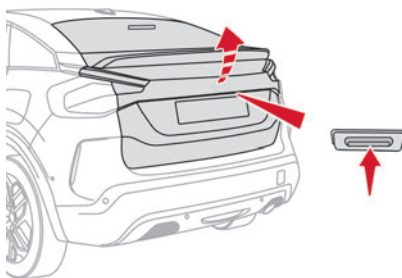

► After unlocking the vehicle, press the opening control and then lift the tailgate.

Closing

► Lower the tailgate using one of the interior grab handles.

! In the event of a malfunction or if you experience difficulty opening or closing the tailgate, have it checked by a CITROËN dealer or a qualified workshop without delay, to avoid the issue deteriorating and prevent any risk of the tailgate dropping, potentially causing serious injury.

Back-up release

To manually unlock the boot in the event of a battery or central locking failure.

Unlocking

► Fold the rear seats to gain access to the lock from inside the boot.

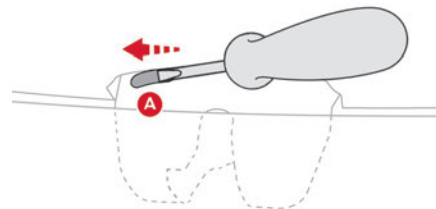

► Insert a small screwdriver into hole **A** of the lock to unlock the boot.

► Move the latch to the left.

Locking after closing

If the fault persists after closing again, the boot will remain locked.

i In the event of a fault with the central locking system, it is essential to disconnect the battery to lock the boot and so ensure complete locking of the vehicle.

Alarm

(Depending on version)

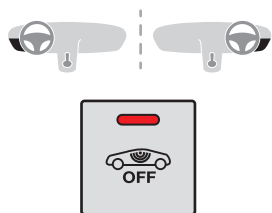

System which protects and provides a deterrent against theft and break-ins.

Exterior perimeter monitoring

The system checks for opening of the vehicle. The alarm is triggered if anyone tries to open a door, the boot or the bonnet, for example.

Interior volumetric monitoring

The system checks for any variation in volume in the passenger compartment.

The alarm is triggered if anyone breaks a window, enters the passenger compartment or moves inside the vehicle.

Self-protection function

The system checks whether any of its components are out of service.

The alarm is triggered if the battery, the central control or the siren wiring is put out of service or damaged.



Work on the alarm system

Contact a CITROËN dealer or a qualified workshop.

Locking the vehicle with full alarm system

Activation

- ▶ Switch off the ignition and exit the vehicle.
- ▶ Lock or deadlock the vehicle using the remote control or by pressing on the driver's door handle.

When the monitoring system is active, the red indicator lamp in the button flashes once per second and the direction indicators come on for about 2 seconds.

The exterior perimeter monitoring is activated after 5 seconds and the interior volumetric monitoring after 45 seconds.



The alarm does not activate when locking automatically from a distance.



If an opening (door, boot or bonnet) is not properly closed, the vehicle is not locked, but the exterior perimeter monitoring will be activated after 45 seconds, at the same time as the interior volumetric monitoring.

Deactivation



▶ Press the remote control unlocking button.

or

▶ Unlock the vehicle by pressing the driver's door handle.

The monitoring system is deactivated: the indicator lamp in the button goes off and the direction indicators flash for about 2 seconds.



After unlocking using the remote control

If the vehicle automatically locks itself again (as happens if a door or the boot is not opened within 30 seconds of unlocking), the monitoring system is automatically activated.

Locking the vehicle with exterior perimeter monitoring only

Deactivate the interior volumetric monitoring to avoid the unwanted triggering of the alarm, in certain cases such as:

- Slightly open window.
- Washing the vehicle.
- Changing a wheel.
- Towing the vehicle.
- Transport on a ship or ferry.

Deactivating interior volumetric monitoring

- ▶ Switch off the ignition and within 10 seconds press the alarm button until the indicator lamp is on fixed.
- ▶ Exit the vehicle.
- ▶ Immediately lock the vehicle using the remote control or by pressing on the driver's door handle.

Only exterior perimeter monitoring is activated; the red indicator lamp in the button flashes every second.

To take effect, this deactivation must be performed whenever the ignition is switched off.

Reactivating interior volumetric monitoring

► Deactivate exterior perimeter monitoring by unlocking the vehicle using the remote control or the "Keyless Entry and Start" system.

The indicator lamp in the button goes off.

► Reactivate the full alarm system by locking the vehicle using the remote control or by pressing the driver's door handle.

The red indicator lamp in the button once again flashes every second.

Triggering of the alarm

This is indicated by sounding of the siren and flashing of the direction indicators for 30 seconds.

Depending on the country of sale, certain monitoring functions remain active until the alarm has been triggered eleven times consecutively.

When the vehicle is unlocked using the remote control or the Keyless Entry and Start system, rapid flashing of the red indicator lamp in the button informs you that the alarm was triggered during your absence. When the ignition is switched on, this flashing stops.

Failure of the remote control

To deactivate the monitoring functions:

- Unlock the vehicle using the key in the front left-hand door lock.
- Open the door; the alarm is triggered.
- Switch on the ignition; this stops the alarm. The indicator lamp in the button goes off.

Locking the vehicle without activating the alarm

- Lock the vehicle using the key (built-in the remote control) in the front left-hand door lock.

Malfunction

When the ignition is switched on, the fixed lighting of the red indicator lamp in the button indicates a system malfunction.

Have it checked by a CITROËN dealer or a qualified workshop.

Automatic activation

(Depending on version)

The system is activated automatically 2 minutes after the last door or the boot is closed.

- To avoid triggering the alarm on entering the vehicle, first press the unlocking button on the remote control or unlock the vehicle using the "Keyless Entry and Start" system.

Electric windows

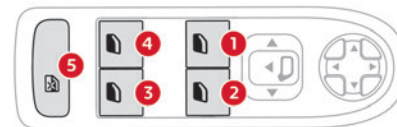

1. Left-hand front
2. Right-hand front
3. Right-hand rear
4. Left-hand rear
5. Deactivation of electric window controls located by rear seats

Manual operation

- To open/close the window, press/pull the switch without passing the point of resistance; the window stops as soon as the switch is released.

Automatic operation

- To open/close the window, press/pull the switch past its resistance point: the window opens/closes completely when the switch is released.

Operating the switch again stops the movement of the window.

i The electric window controls remain operational for approximately 45 seconds after switching off the ignition. After that time, the controls are disabled. To reactivate them, switch the ignition on again.

Anti-pinch

If the window meets an obstacle while rising, it stops and immediately partially lowers again.

Deactivating the rear controls for the rear electric windows



For your children's safety, press control **5** to deactivate the controls for the rear electric windows, irrespective of their positions. The red indicator lamp in the button comes on. The rear electric windows can still be controlled using the driver's controls.

i In the event of a serious impact, use of the rear electric window controls is re-enabled, if they had been deactivated.

Reinitialising the electric windows

After reconnecting the battery, or in the event of abnormal window movement, the anti-pinch function must be reinitialised.

The anti-pinch function is disabled during the following sequence of operations.

For each window:

- ▶ Lower the window fully, then raise it; it will rise in steps of a few centimetres each time the control is pressed. Repeat the operation until the window is fully closed.
- ▶ Continue to pull the control for at least one second after the window reaches the closed position.

! If an electric window meets an obstacle during operation, the movement of the window must be reversed. To do this, press the relevant control.

When the driver operates the passengers' electric window controls, it is important to ensure that nothing can prevent the window from closing properly.

It is important to ensure that passengers use the electric windows correctly.

Pay particular attention to children when operating the windows.

Be aware of passengers and/or other persons present when closing windows using the key or the "Keyless Entry and Start" system.

Do not put your head or arms through the open windows when the vehicle is moving - risk of serious injury!

Sunroof

The sunroof consists of a movable glass panel that slides over the roof and a blind that can be opened independently. Opening the sunroof automatically opens the blind.

▶ To operate the panoramic sunroof, use the button in the roof console.



The sunroof can be operated when the ignition is turned on (if the battery is charged enough), with the engine running, in STOP mode of Stop & Start, and up to 45 seconds after turning off the ignition.

Precautions

! Do not put your head or arms through the sunroof while the vehicle is moving - risk of serious injury!

! Ensure that any luggage or accessories carried on the roof bars do not interfere with the movement of the sunroof. Do not place heavy loads on the movable glass panel of the sunroof.

! If the sunroof is wet, following a shower or washing the vehicle, wait until it is completely dry before opening. Do not operate the sunroof if it is covered by snow or ice - risk of damage! Use only plastic scrapers to remove snow or ice from the sunroof.

! Regularly check the condition of the sunroof seals (e.g. presence of dust, dead leaves). If using a car wash, check first that the roof is correctly closed and keep the high-pressure jet at least 30 centimetres from the seals.

! Never leave the vehicle with the sunroof open.

Operation

When opening the sunroof fully, the movable glass moves to a partially open position, then slides over the roof. Any intermediate position is possible.

! Before operating the sunroof control button, ensure that no object or person might prevent the movement. Pay particular attention to children when operating the sunroof. If something is trapped when operating the sunroof, reverse the movement of the sunroof by pressing the control button in question. The driver must ensure that passengers use the sunroof correctly. Any manual intervention on the position of the sunroof may disturb the anti-pinch device. Perform a reinitialisation.

Anti-pinch system

If the sunroof encounters an obstacle when closing, the movement is automatically reversed.

Opening/closing the sunroof

- ▶ To open the sunroof, use the part of the button located towards the rear.
- ▶ To close the sunroof, use the part of the button located towards the front.

Operating the button

- ▶ Pressing the button beyond its point of resistance opens or closes the sunroof fully.
- ▶ Pressing the button again stops the movement in progress.
- ▶ By keeping the button pressed (without going beyond the point of resistance), the movement of the glass stops when this button is released.

- ▶ When the sunroof is closed: pressing once without passing the point of resistance moves it to the partially open position.
- ▶ When the sunroof is partially open: pressing once on the front part of the button, without going beyond the point of resistance, closes it completely.

i The sunroof and windows can be closed by holding down the remote control locking button.

Opening/closing the blind

- ▶ To open the blind, pull its handle backwards until the desired position is reached.
- ▶ To close the blind, push its handle forwards until the desired position is reached.

Reinitialisation

Reinitialisation is required after reconnecting the battery, or if the sunroof malfunctions or moves in a jerky manner.

- ▶ Check that nothing is affecting the movement of the sunroof and that the seals are clean.



- ▶ With the ignition on, press and hold the front part of the button to close the sunroof.

The sunroof closes step by step. When fully closed, it performs a slight opening/closing movement.

- ▶ Release the button 1 second after the end of the movement.

Correct driving position

! For safety reasons, adjustments must only be made when the vehicle is stationary.

Before taking to the road and to make the most of the ergonomic layout of the instruments and controls, carry out these adjustments in the following order:

- head restraint height.
- seat backrest angle.
- seat cushion height.
- longitudinal seat position.
- steering wheel height and reach.
- rear view mirror and door mirrors.

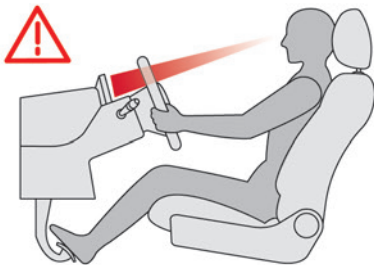

! Once these adjustments have been made, check that the instrument panel can be viewed correctly from your driving position.

Front head restraints

Adjusting the height



Upwards:

▶ Pull the head restraint up to the desired position; you can feel the head restraint clicking into position.

Downwards:

▶ Press lug **A** to lower the head restraint.

i The head restraint is correctly adjusted when its upper edge is level with the top of the head.

Removing a head restraint

- ▶ Tilt the backrest to the rear to make it easier to remove the head restraint.
- ▶ Pull the head restraint fully up.
- ▶ Press lug **A** to release the head restraint and raise it fully.
- ▶ Stow the head restraint securely.

Refitting a head restraint

- ▶ Insert the head restraint rods into the guides in the corresponding seat backrest.
- ▶ Push the head restraint fully down.
- ▶ Press the lug **A** to release the head restraint and push it down.
- ▶ Adjust the height of the head restraint.

! Never drive with the head restraints removed; they should be in place and adjusted for the occupant of the seat.

Front seats

! Before moving the seat backwards, ensure that there is no person or object that might prevent the full travel of the seat. There is a risk of trapping or pinching passengers if present in the rear seats or of jamming the seat if large objects are placed on the floor behind the seat.

Manual adjustments

Longitudinal

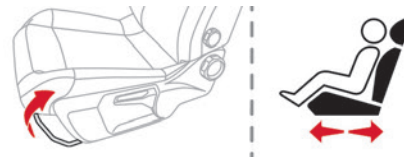

- ▶ Raise the control bar and slide the seat forwards or backwards.
- ▶ Release the control bar to lock the seat in position on one of the notches.

Backrest angle

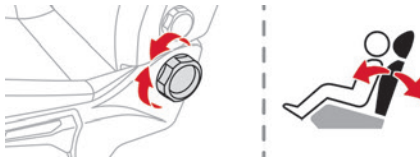

- ▶ Turn the knob to obtain the desired angle.

Height

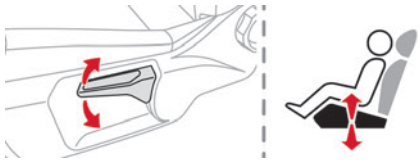

- ▶ Pull the control upwards to raise or push it downwards to lower, until you obtain the position required.

Lumbar (driver only)



- ▶ Turn the knob to obtain the desired level of lumbar support.

Electric adjustments

Backrest angle

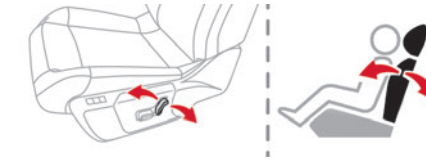

- ▶ Tilt the control forwards or rearwards.

Cushion height



- ▶ Tilt the rear of the control upwards or downwards to obtain the required height.

Lumbar



- ▶ Press one of the controls to obtain the desired lumbar support.

Massage function

This function provides lumbar massage; it only operates when the engine is running as well as in STOP mode of the Stop & Start system.

Activation/Deactivation

- ▶ Press this button to activate/deactivate the function.

Upon activation, the indicator lamp comes on. The massage function is activated for a period of one hour.

During this time, massage is performed in 6 cycles of 10 minutes (6 minutes of massage followed by a 4-minute break).

After one hour, the function is deactivated; the indicator lamp goes off.

Heated seats

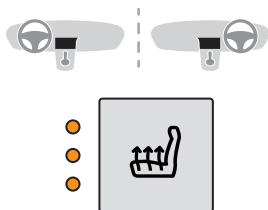

The function is active only with the engine running and when the outside temperature is below 20°C.

- ▶ Press the button corresponding to the seat.
- ▶ Each press changes the heating level; the corresponding number of indicator lamps come on.
- ▶ To switch off the heating, press the button until all of the indicator lamps are off.

The system status is memorised when the ignition is switched off.



Do not use the function when the seat is not occupied.

Reduce the heating intensity as soon as possible.

When the seat and passenger compartment have reached a satisfactory temperature, switch the function off; reducing electrical consumption in turn decreases energy consumption.

! Prolonged use of heated seats is not recommended for people with sensitive skin.

There is a risk of burns for people whose perception of heat is impaired (e.g. illness, taking medication).

To keep the heated pad intact and to prevent a short circuit:

- Do not place heavy or sharp objects on the seat.
- Do not kneel or stand on the seat.
- Do not spill liquids onto the seat.
- Never use the heating function if the seat is damp.

Steering wheel adjustment

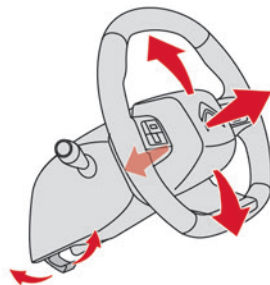

- ▶ When stationary, pull the control to release the steering wheel.

- ▶ Adjust the height and reach to suit your driving position.
- ▶ Push the control to lock the steering wheel.

! For safety reasons, these adjustments must only be carried out with the vehicle stationary.

Heated steering wheel

(Depending on country of sale)

In cold weather, this function heats the circular part of the steering wheel.

It can be activated when the outside temperature is below 20°C.

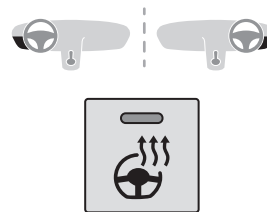

- ▶ With the engine running, press this button to activate/deactivate the function (confirmed by the indicator lamp coming on/going out). The system is automatically deactivated every time the engine is switched off.

Mirrors

Door mirrors

! As a safety measure, the mirrors should be adjusted to reduce the "blind spots". The objects that you see in the mirrors are in fact closer than they appear. Take this into account in order to correctly judge the distance of vehicles approaching from behind.

Adjustment

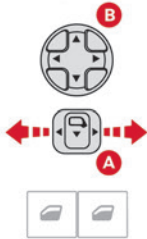

- ▶ Move control **A** to the right or to the left to select the corresponding mirror.
- ▶ Move control **B** in any of the four directions to adjust.
- ▶ Return control **A** to its central position.

Manual folding

The mirrors can be folded manually (parking obstruction, narrow garage, etc.).

- ▶ Turn the mirror towards the vehicle.

Electric folding

Depending on equipment, the door mirrors can be folded electrically.



- ▶ From the inside, with the ignition on, place control **A** in the central position.
- ▶ Pull control **A** backwards.

- ▶ Lock the vehicle from the outside.

i If the mirrors are folded using control **A**, they will not unfold when the vehicle is unlocked.

Electric unfolding

- ▶ From outside: unlock the vehicle.
- ▶ From inside: with the ignition on, place control **A** in the central position and then pull it rearwards.

i The remote-controlled automatic door mirror folding/unfolding function is configured via the **Driving / Vehicle** touch screen menu.

Demisting/Defrosting



The demisting/defrosting of the door mirrors works with the demisting/defrosting of the rear screen.

For more information on **Rear screen demisting/defrosting**, refer to the corresponding section.

Interior rear view mirror

Equipped with an anti-dazzle system, which darkens the mirror glass and reduces the nuisance to the driver caused by the sun, headlamps of other vehicles, etc.

Manual model

Day/night position

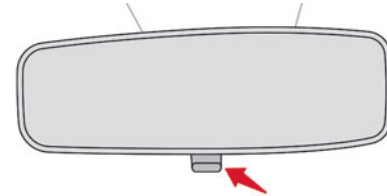

- ▶ Pull the lever to change to the anti-dazzle "night" position.
- ▶ Push the lever to change to the normal "day" position.

Adjustment

- ▶ Adjust the mirror to the normal "day" position.

Automatic "electrochrome" model

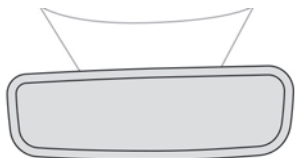

The electrochrome system uses a sensor that detects the level of exterior brightness and that coming from the rear of the vehicle, in order to automatically and gradually switch between day and night usage.

i To ensure optimum visibility while manoeuvring, the mirror automatically brightens when reverse gear is engaged. The system is deactivated if the load in the boot exceeds the height of the load space cover or if the load space cover has items placed on it.

Rear bench seat

Bench seat with fixed cushions and split folding backrests (2/3-1/3) to adapt the boot load space.

i The rear seat cushion remains fixed. To increase the boot loading volume, tilt the bench seat backrest.

Rear head restraints

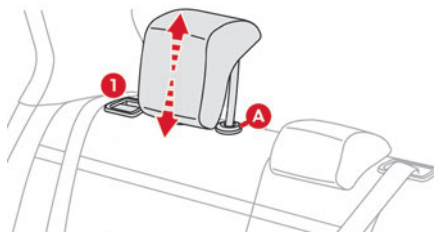

They have two positions:

- A **high position**, for when the seat is in use:
 - ▶ Pull the head restraint fully up.
- A **low position**, for stowing, when the seat is not in use:
 - ▶ Press the lug **A** to release the head restraint and push it down.

The rear head restraints can be removed.

Removing a head restraint

- ▶ Release the backrest using control **1**.
- ▶ Tilt the backrest slightly forwards.
- ▶ Pull the head restraint fully up.
- ▶ Press the lug **A** to release the head restraint and remove it completely.

Refitting a head restraint

- ▶ Insert the head restraint rods into the guides in the corresponding backrest.
- ▶ Push the head restraint fully down.
- ▶ Press the lug **A** to release the head restraint and push it down.

! Never drive with passengers seated at the rear when the head restraints are removed; the head restraints should be in place and in the high position. The head restraint for the centre seat and those for the outer seats are not interchangeable.

Folding the backrests

! Manoeuvring the backrests should only be done when the vehicle is stationary.

First steps:

- ▶ Lower the head restraints.
- ▶ If necessary, move the front seats forward.
- ▶ Check that no person or object might interfere with the folding of the backrests (e.g. clothing, luggage).

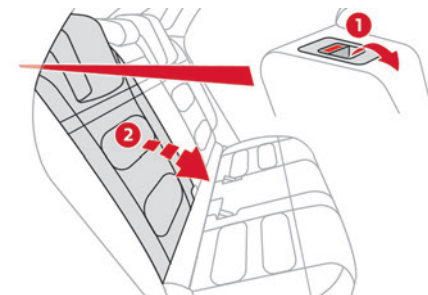

- ▶ Press the backrest release grip **1**.

► Guide the backrest **2** down to the horizontal position.

i When the backrest is released, the red indicator in the release grip is visible.

Repositioning the backrests

! First check that the outer seat belts are lying vertically flat alongside the backrest latching rings.

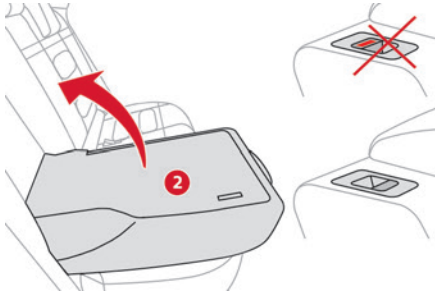

- Put the backrest **2** in the upright position and push it firmly to latch it home.
- Check that the red indicator is no longer visible in the release grip **1**.
- Ensure that the outer seat belts were not trapped during the operation.

! Please note: an incorrectly latched backrest compromises the safety of

passengers in the event of sudden braking or an accident.

The contents of the boot may be thrown forwards - risk of serious injury!

Heated seats

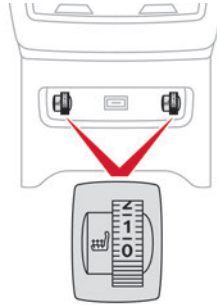

The control knobs for each side seat are located at the rear of the centre console.

► Turn the corresponding knob to switch on and select a setting:

- 0 = off.
- 1 = low.
- 2 = medium.
- 3 = high.

The function is active only with the engine running and when the outside temperature is below 20°C.



Do not use the function when the seat is not occupied.

Reduce the heating intensity as soon as possible.

When the seat and passenger compartment have reached a satisfactory temperature, switch the function off; reducing electrical consumption in turn decreases energy consumption.



Prolonged use of heated seats is not recommended for people with sensitive skin.

There is a risk of burns for people whose perception of heat is impaired (e.g. illness, taking medication).

To keep the heated pad intact and to prevent a short circuit:

- Do not place heavy or sharp objects on the seat.
- Do not kneel or stand on the seat.
- Do not spill liquids onto the seat.
- Never use the heating function if the seat is damp.

Heating and Ventilation

Air intake

The air circulating in the passenger compartment is filtered and originates either from the exterior, via the grille located at the base of the

windscreen, or from the inside in air recirculation mode.

Controls

Depending on version, the controls are accessible in the **Climat** touch screen menu or are grouped together on the centre console panel.

Air distribution

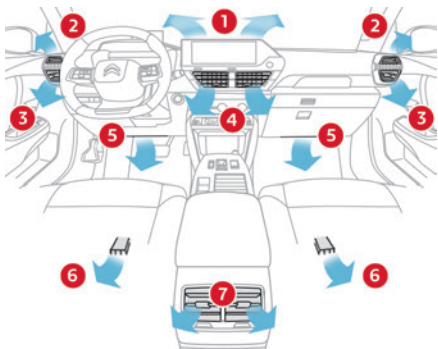

1. Windscreen demisting/de-icing vents
2. Front side window demisting/de-icing vents
3. Adjustable and closable side air vents
4. Adjustable and closable central air vents
5. Air outlets to the front footwells
6. Air outlets to the rear footwells
7. Adjustable and closable air vents

Advice

Using the ventilation and air conditioning system

- ▶ To ensure that air is distributed evenly, keep the external air intake grilles at the base of the windscreen, the nozzles, the vents, the air outlets and the air extractor in the boot free from obstructions.
 - ▶ Do not cover the sunshine sensor located on the dashboard; this sensor is used to regulate the automatic air conditioning system.
 - ▶ Operate the air conditioning system for at least 5 to 10 minutes once or twice a month to keep it in good working order.
 - ▶ If the system does not produce cold air, switch it off and contact a CITROËN dealer or a qualified workshop.
- When towing a large load on a steep gradient in high temperatures, switching off the air conditioning increases the available engine power, enhancing the towing capacity.

! Avoid driving for too long with the ventilation off or with prolonged operation of interior air recirculation. Risk of misting and deterioration of the air quality!

🌿 If the interior temperature is very high after the vehicle has stood for a long

time in the sunshine, air the passenger compartment for a few moments.

Put the air flow control at a setting high enough to quickly change the air in the passenger compartment.

i Condensation created by the air conditioning results in a discharge of water underneath the vehicle. This is perfectly normal.

Servicing the ventilation and air conditioning system

- ▶ Ensure that the passenger compartment filter is in good condition and have the filter elements replaced regularly. We recommend using a composite passenger compartment filter. Its specific active additive helps protect against polluting gases and bad smells.
- ▶ To ensure correct operation of the air conditioning system, have it checked according to the recommendations in the Manufacturer's service schedule.

Stop & Start

The heating and air conditioning systems only operate when the engine is running. Temporarily deactivate the Stop & Start system to maintain a comfortable temperature in the passenger compartment.

For more information on the **Stop & Start** system, refer to the corresponding section.

ECO driving mode

Selecting this mode reduces electrical energy consumption, but restricts the performance of the heating and air conditioning systems, although it does not deactivate them.

Manual air conditioning

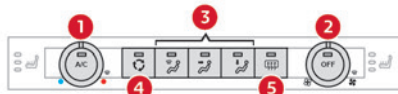

1. Adjusting the temperature
Air conditioning on/off
2. Adjusting the air flow
System switch-off
3. Adjusting the air distribution
4. Interior air recirculation
5. Rear screen demisting/de-icing

The air conditioning system only operates with the engine running.

Adjusting the temperature

- ▶ Turn the knob **1** from blue (cold) to red (hot).

Air flow adjustment

- ▶ Turn the thumbwheel **2** to obtain a sufficient air flow to ensure your comfort.

If the air flow control is in the **minimum** position (system deactivated), the temperature in the vehicle will no longer be controlled. A slight flow of air can still be felt, due to the forward movement of the vehicle.

Adjusting the air distribution



Windscreen and side windows

Central and side air vents

Footwells

- ▶ Press one of the buttons **3** to adjust the air distribution inside the passenger compartment. The lighting of the button indicates that air is being blown in the specified direction. It is possible to activate the following buttons simultaneously:
 - Central and side air vents + footwells.
 - Windscreen and side windows + footwells.

Air conditioning on/off

The air conditioning system is designed to operate effectively in all seasons, with the windows closed. It is used to:

- lower the temperature in summer,
- increase the effectiveness of demisting in winter, above 3°C.
- ▶ Press knob **1** to turn the air conditioning on/off.

When the system is activated, the indicator lamp comes on.

Information: Air conditioning does not operate when the air flow is disabled.

To obtain cool air more quickly, enable interior air recirculation for a brief period. Then return to the intake of exterior air.

Switching off the air conditioning may result in some discomfort (humidity or misting).

Switching the system off

- ▶ Press knob **2**; all the indicator lamps of the system go out. This action deactivates all of the functions of the air conditioning system. The temperature is no longer regulated. A slight flow of air can still be felt, due to the forward movement of the vehicle.

Dual-zone automatic air conditioning

This system automatically controls the activation of the air conditioning system, regulating the temperature, air flow and air distribution inside the passenger compartment.

To adjust the system, use the central controls or press the button in the **Climate** menu on the touch screen to display the controls page.

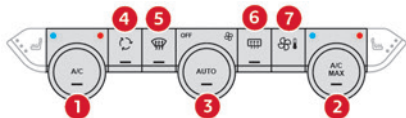

Central controls

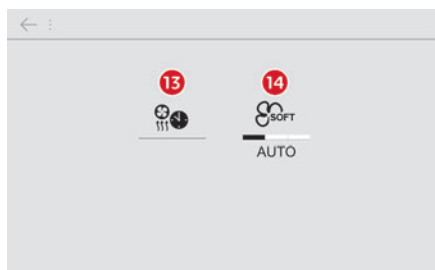
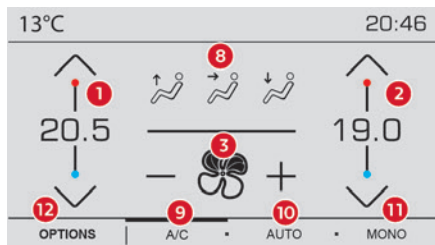

Touch screen

1. Left-hand side temperature adjustment
Air conditioning on/off (central controls)

2. Right-hand side temperature adjustment
Maximum air conditioning (central controls)
3. Adjusting the air flow
Automatic Comfort programme (central controls)
4. Interior air recirculation
5. Automatic Visibility programme
6. Rear screen demisting/de-icing
7. Direct access to the **Climate** menu
8. Adjusting the air distribution
9. Air conditioning on/off
10. Automatic Comfort programme
11. Mono-zone/Dual-zone
12. Access to the secondary page
13. Temperature conditioning (depending on version)
14. Selection of setting for the Automatic Comfort programme (Soft/Normal/Fast).

This system works with the engine running but access to the ventilation and its controls remains possible with the ignition on.

Adjusting the temperature

The driver and front passenger can each choose their own temperature setting.

The value indicated corresponds to a level of comfort and not to a precise temperature.

- ▶ Turn the knob **1** or **2** or press one of the buttons **1** or **2** on the touch screen to increase (red) or decrease (blue) the value. It is recommended that you avoid a difference of more than 3°C in the settings for left and right.

Automatic Comfort programme

This automatic mode ensures optimum management of the passenger compartment temperature, air flow and air distribution, based on the selected comfort level.

- ▶ Press knob **3** on the central controls or button **10** on the touch screen to activate/deactivate the air conditioning system's automatic mode.

The indicator lamp in the button lights up when the air conditioning system is operating automatically.

You can adjust the intensity of the automatic Comfort programme by using the "**OPTIONS**" button to select one of the available settings:

- "**Soft**": provides soft and quiet operation by limiting air flow.
- "**Normal**": offers the best compromise between a comfortable temperature and quiet operation (default setting).
- "**Fast**": provides strong and effective air flow.

To change the current setting (shown by the corresponding indicator lamp), press button **14** repeatedly until the desired setting is displayed. To ensure passenger comfort in the rear seats, favour "**Normal**" and "**Fast**" settings.

This setting is associated with automatic mode only. However, on deactivation of **AUTO** mode, the indicator lamp for the most recently selected setting remains on.

Changing the setting does not reactivate **AUTO** mode if it was deactivated.

i In cold weather with the engine cold, the air flow is increased gradually until the comfort setting has been reached, in order to limit the delivery of cold air into the passenger compartment.

On entering the vehicle, if the interior temperature is much colder or warmer than the comfort setting requested, there is no need to alter the value displayed to more quickly reach the required level of comfort. The system automatically corrects the temperature difference as quickly as possible.

Manual control

It is possible to manually adjust one or more of these functions, while the system retains automatic control of the other functions:

- air flow.
- air distribution.

The indicator lamp in the "AUTO" button goes out if a setting is changed.

► Press knob **3** or button **10** of the touch screen again to reactivate the automatic Comfort programme.

Adjusting the air flow

► Turn the knob **3** or press one of the buttons **3** on the touch screen to increase or decrease the air flow.

The air flow symbol (a fan) is filled in according to the request.

When the air flow is reduced to a minimum, ventilation stops.

"OFF" is displayed alongside the fan.

Adjusting the air distribution

► Press the buttons **8** on the touch screen to adjust the air flow distribution inside the passenger compartment.



Windscreen and side windows

Central and side air vents

Footwells

The lighting of the button indicates that air is being blown in the specified direction.

It is possible to activate the following buttons simultaneously:

- Central and side air vents + footwells
- Windscreen and side windows + footwells

Air conditioning on/off

The air conditioning system is designed to operate effectively in all seasons, with the windows closed.

It is used to:

- lower the temperature in summer,
- increase the effectiveness of demisting in winter, above 3°C.

► Press knob **1** or button **9** on the touch screen to activate/deactivate the air conditioning.

When the system is activated, the indicator lamp comes on.

i Air conditioning does not operate when the air flow is disabled.

To obtain cool air more quickly, enable interior air recirculation for a brief period. Then return to the intake of exterior air.

Switching off the air conditioning may result in some discomfort (humidity or misting).

Maximum air conditioning

This function automatically adjusts the temperature setting to the lowest possible, the air distribution towards the central and side air vents, the air flow to maximum and activates interior air recirculation.

► Press knob **2** to activate/deactivate the function (confirmed by the indicator lamp coming on/switching off).

Once the function is deactivated, the system returns to the previous settings.

Mono-zone/Dual-zone

The passenger temperature setting can be linked to the driver's setting (mono-zone function).

► Press button **11** to activate the "MONO" function.

The function is automatically deactivated if the passenger uses their temperature adjustment buttons (dual-zone function).

Automatic Visibility programme

For more information on button **5**, refer to the "Front Demisting/Defrosting" section.

Ventilation with the ignition on

When the ignition is switched on, you can use the ventilation system to adjust the air flow settings and the air distribution in the passenger compartment, for a period which depends on the battery charge.

This function does not operate the air conditioning.

Interior air recirculation

The intake of exterior air prevents the formation of mist on the windscreen and side windows. Recirculating the interior air isolates the passenger compartment from outside odours and fumes and allows the desired passenger compartment temperature to be achieved more rapidly.

 ► Press this button to activate/deactivate the function (confirmed by the illumination/extinction of the indicator lamp).

 This function is activated automatically when reverse gear is engaged.

Front demisting - defrosting

With manual air conditioning

- Adjust the temperature to maximum (red).
- Adjust the air flow to maximum.
-  ► Press this button to activate the air distribution to the "Windscreen" position; its indicator lamp comes on.
- Check that the recirculation of interior air is deactivated; its indicator lamp must be off.
- Switch on the air conditioning by pressing the "A/C" button; its indicator lamp comes on.

With automatic dual-zone air conditioning

Automatic Visibility programme

This mode allows the windscreen and side windows to be demisted or defrosted as quickly as possible.

 ► Press this button to activate/deactivate the mode (confirmed by the illumination/extinction of the indicator lamp).

The programme automatically manages the air conditioning (depending on version), air flow and air intake, and provides optimum distribution towards the windscreen and side windows.

It is possible to manually change the air flow without deactivating the automatic Visibility programme.

 With Stop & Start, when demisting has been activated, STOP mode is not available.

 In wintry conditions, before moving off, remove all snow or ice on the windscreen near the camera. Otherwise, the operation of the equipment using the camera may be affected.

Heated windscreen

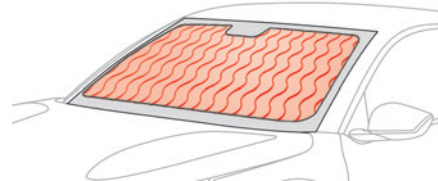

In cold weather, this function heats the entire windscreen and complements the Automatic Visibility programme to speed up the evacuation of elements that interfere with visibility (e.g. dew, mist, frost, snow), located on either side of the windscreen.

It can be used both before setting off and while driving.

Switching on/off



► With the engine running, press this button to activate/deactivate the function (confirmed by an indicator lamp).

The period of operation depends on the outside temperature.

The function switches off automatically to prevent excessive power consumption.

Rear screen demisting/defrosting

This demisting/de-icing only works with the engine running.

It also demists/de-ices the door mirrors.

► Press this button to activate/deactivate the function (confirmed by the indicator lamp coming on/switching off).

The function can be activated whatever the outside temperature may be.

The period of operation depends on the outside temperature.

Demisting/defrosting therefore switches off automatically to prevent an excessive consumption of electrical current.

Temperature conditioning (Electric)

This function allows you to programme the temperature in the passenger compartment to reach a pre-defined, non-modifiable temperature (approx. 21°C) before you enter the vehicle, on the days and at the times of your choice.

This function is available when the vehicle is connected or not connected.

Programming

With 10-inch touch screen

In the **Climate > OPTIONS** menu:



Select **Temperature conditioning**.

- Press **+** to add a programme.
- Select the time of entry into the vehicle and the desired days. Press **OK**.
- Press **ON** to activate this programme.

The temperature pre-conditioning sequence begins approximately 45 minutes before the programmed time when the vehicle is connected (20 minutes when it is not connected) and is maintained for 10 minutes after.

! You can set multiple programmes. Each one is saved in the system.

To optimise the driving range, we recommend starting a programme while the vehicle is connected.



Programming can also be carried out from a smartphone using the **MyCitroën**

App application.

For more information on **Remote functions**, refer to the corresponding section.

! The fan noise that occurs during temperature pre-conditioning is perfectly normal.

Operating conditions

– The function is only activated when the **ignition is switched off** and the **vehicle locked**.

– When the vehicle is not connected, the function is only activated if the battery charge level is greater than 50%.

– When the vehicle is not connected and a recurring programme is active (e.g. from Monday to Friday), if two temperature pre-conditioning sequences are run without the vehicle being used, the programme will be deactivated.

Interior fittings

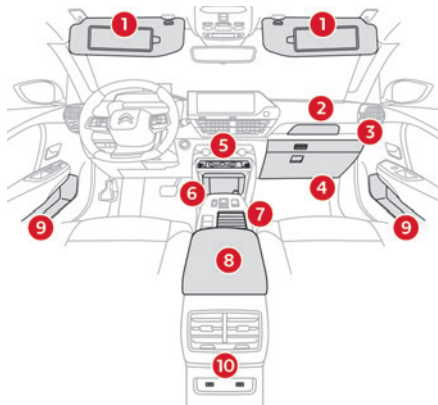

1. Sun visor
2. Smart Pad Support Citroën
3. Dashboard drawer
4. Glove box
5. Wireless smartphone charger
6. Storage compartment
12 V socket
7. Storage compartment with cup holders
8. Centre armrest with storage compartment
9. Door pockets
10. USB sockets
Heated rear seats

! Make sure you do not leave any item in the passenger compartment which could

act like a magnifying glass under the effect of the sun's rays and cause a fire - risk of fire or damage to interior surfaces!

Sun visor

- ▶ With the ignition on, raise the concealing flap; depending on the version, the mirror is illuminated automatically.
- This sun visor is also equipped with a ticket holder.

Glove box

- ▶ To open the glove box, lift the handle.
- With the ignition on, the glove box is lit when open.

! Never drive with the glove box open when a passenger is at the front. It may cause injury during sharp deceleration!

Dashboard drawer

- ▶ To open the drawer, press the handle and pull.

! Never drive with the drawer open and a passenger in the front seat - risk of injury during sharp deceleration!

Smart Pad Support Citroën

This allows you to place a mobile device, such as a smartphone or touch screen tablet, into a dedicated holder (sold separately).

- ▶ Press the bracket to make it pop out.
- ▶ Open the clamp on the back of the holder to insert the mobile device.

i Remove the mobile device before stowing the bracket.

USB sockets

These symbols determine the type of use of a USB socket:



Power supply and recharging.



Likewise, plus exchange of multimedia data with the audio system.

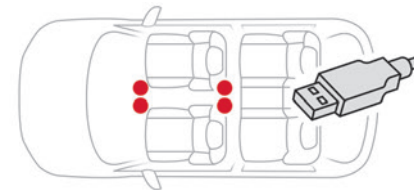

USB sockets allow the connection of a portable device.



The USB socket located at the front on the left-hand side also allows a smartphone to be connected by Android

Auto® or CarPlay®, enabling certain smartphone applications to be used on the touch screen. For best results, use a cable made or approved by the device manufacturer.

These applications can be managed using the steering-mounted controls or the audio system controls.

- When the USB socket is used, the portable device charges automatically. While charging, a message is displayed if the power drawn by the portable device exceeds the current supplied by the vehicle. For more information about how to use this equipment, refer to the sections describing the audio and telematics systems.

12 V accessory socket

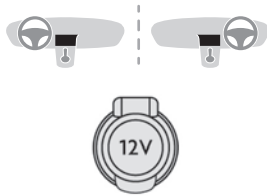

- Plug in a 12 V accessory (with a maximum rated power of 120 W) using a suitable adapter.

- Observe the maximum power rating to avoid damaging the accessory.

- The connection of an electrical device not approved by CITROËN, such as a USB charger, may adversely affect the operation of vehicle electrical systems, causing faults such as poor radio reception or interference with displays in the screens.

Wireless smartphone charger

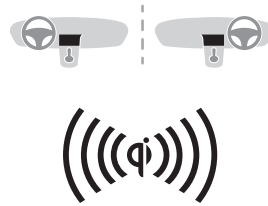

This system allows wireless charging of a portable device such as a smartphone, using the magnetic induction principle, in accordance with the Qi 1.1 standard.

The portable device to be charged must be compatible with the Qi standard, either by design or by using a compatible holder or shell.

A mat can also be used provided that it is approved by the Manufacturer.

The charging area is identified by the Qi symbol. The charger works with the engine running and with the Stop & Start system in STOP mode. Charging is managed by the smartphone.

With the Keyless Entry and Start system, the charger's operation may be briefly disrupted when a door is opened or the ignition is switched off.

Charging

- With the charging area clear, place a device in its centre.



When the portable device is detected, the charger's indicator lamp lights up green. It remains lit for the whole time that the battery is being charged.

- The system is not designed to charge multiple devices simultaneously.

- Do not leave metal objects (e.g. coins, keys, vehicle remote control) in the charging area while a device is being charged - Risk of overheating or interrupting the charging!



- When using applications for a long time in combination with wireless charging, some smartphones may switch to thermal safety and cause some functions to stop.

Checking operation

The state of the indicator lamp allows the operation of the charger to be monitored.

State of the indicator lamp	Meaning
Off	Engine switched off. No compatible devices detected. Charging complete.
Fixed green	Compatible portable device detected. Charging.
Flashing orange	Foreign object detected in the charging zone. Portable device not well centred in the charging zone.
Fixed orange	Malfunction of the portable device's battery meter. Device battery temperature too high. Charger malfunction.



If the indicator lamp is fixed orange:

- remove the device, then place it back in the centre of the charging zone.

or

- remove the device and try again in a quarter of an hour.
- If the problem persists, have the system checked by a CITROËN dealer or a qualified workshop.

CITROËN Hi-Fi system

(Depending on version)

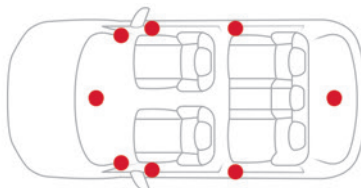

The vehicle is equipped with a high-fidelity acoustic system.

8 speakers offer the pleasure of pure and detailed sound inside the vehicle:

- 2 tweeters and 2 woofers in the front
- 2 full range speakers in the rear
- 1 speaker in the central area of the dashboard
- 1 subwoofer under the trunk carpet

Mats

Fitting

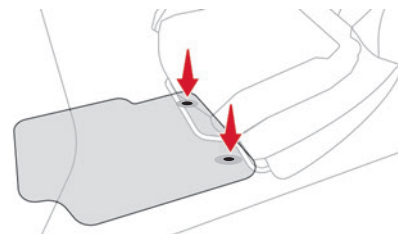

When fitting it on the driver's side, only use the mountings present on the carpet (a "click" indicates proper locking).
The other mats are simply laid over the carpet.

Removing/refitting

- ▶ To remove it on the driver's side, move the seat backwards and unclip the fasteners.
- ▶ To refit it, position the mat and secure it by pressing down.
- ▶ Check that the mat is secured correctly.

! To avoid any risk of jamming the pedals:

- Only use mats which are suited to the fixings already present in the vehicle; these fixings must be used.
- Never fit one mat on top of another.

The use of mats not approved by CITROËN may interfere with access to the pedals and hinder the operation of the cruise control/ speed limiter.

The approved mats have two fasteners located underneath the seat.

Courtesy lamps



1. Front courtesy lamp
2. Front reading lamps



3. Rear courtesy lamp
4. Rear reading lamps

Front and rear courtesy lamps



In this position, the courtesy lamp comes on gradually:

- when the vehicle is unlocked.
- when the key is removed from the ignition switch.

- when a door is opened.
 - when the remote control locking button is activated, in order to locate the vehicle.
- It switches off gradually:
- when the vehicle is locked.
 - when the ignition is switched on.
 - 30 seconds after the last door is closed.



Permanently off.



Permanent lighting.

In "Permanent lighting" mode, the lighting time varies according to the circumstances:

- With the ignition off, approximately 10 minutes.
- In energy saving mode, approximately 30 seconds.
- With the engine running, unlimited.



When the front courtesy lamp is in the "Permanent lighting" position, the rear courtesy lamp also comes on, unless it is in the "Permanently off" position.

To switch off the rear courtesy lamp, put it in the "Permanently off" position.

Reading lamps



▶ With the ignition on, operate the corresponding switch.



Do not place anything against the courtesy lamps.

Interior ambient lighting

The interior ambient lighting casts soft lighting in the passenger compartment, both day and night.



Activation/deactivation and adjustment of the brightness are set via the **Driving/**

Vehicle touch screen menu.

Boot fittings

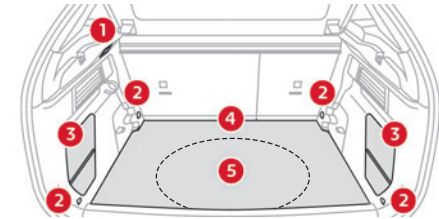

1. Boot lamp
2. Stowing rings
3. Side storage boxes
4. Boot carpet or 2-position boot floor
5. Storage well



The stowing rings are designed to secure luggage using different types of retaining nets.

These retaining nets are available as an accessory.

For more information, contact a CITROËN dealer or a qualified workshop.

2-position boot floor

This two-position floor allows the boot volume to be optimised using the lateral stops located on the sides:

- High position (**100 kg max.**): to obtain a flat floor up to the front seats, when the rear seats are folded down.
- Low position (**150 kg max.**): maximum boot volume.

i On certain versions, the adjustable boot floor cannot be fitted in the low position.

To change the height:

- ▶ Lift and pull the floor towards you using its central handle, then use the lateral stops to move it.
- ▶ Push the floor all the way forwards to place it in the desired position.

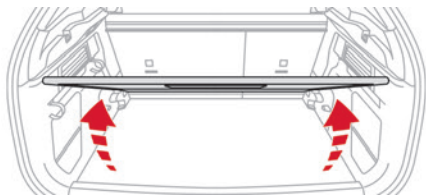

To keep it in the inclined position:

- ▶ From the high position, lift the floor towards the boot.
- ▶ Take it past the retractable stops, then rest the floor on these stops.

Storage well

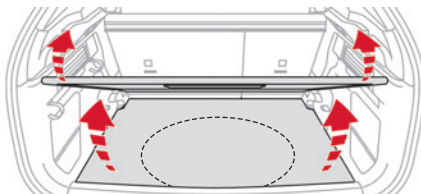

- ▶ Lift the boot floor as far as possible, then lift the carpet to access the storage well.

Depending on version, it includes:

- A temporary puncture repair kit with the tool kit.
- A spare wheel with the tool kit.
- The traction battery charging cable (Electric).

Boot lamp

It comes on automatically when the boot is opened and goes off automatically when the boot is closed.

The lighting time varies according to the circumstances:

- When the ignition is off, approximately 10 minutes.
- In energy saving mode, approximately 30 seconds.
- With the engine running, unlimited.

Lighting control stalk

Main lighting

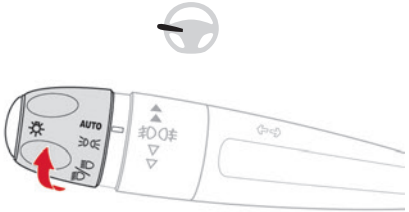

- AUTO** Automatic illumination of lamps/daytime running lamps
- Sidelamps only
- Dipped or main beam headlamps

Headlamp dipping

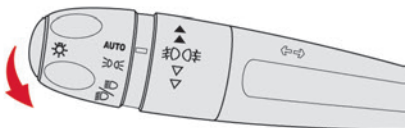

► Pull the lighting control stalk to switch between dipped and main beam headlamps.

In "AUTO" and sidelamps mode, pull the lighting control stalk to switch the main beam headlamps on directly ("headlamp flash").

Display

Illumination of the corresponding indicator lamp on the instrument panel confirms that the selected lighting is on.

A fault with a lamp is signalled by the permanent illumination of this warning lamp, accompanied by the display of a message and an audible signal.

Rear foglamp

It only works if the dipped or main beam headlamps are on.



► Rotate the ring forwards/backwards to turn it on/off.

When the lighting is switched off automatically ("AUTO" position) the foglamp and the sidelamps remain on.

Front foglamps/Rear foglamp

They operate with the sidelamps, dipped or main beam headlamps on.

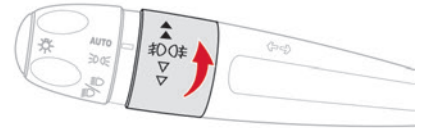

- Rotate the ring forwards:
 - once to switch on the front foglamps,
 - a second time to switch on the rear foglamp.
- Turn in the opposite direction to switch off. If the lighting is switched off automatically ("AUTO" position) or the dipped beam headlamps are switched off manually, the foglamps and sidelamps remain on.
- Rotate the ring backwards to switch the foglamps off; the sidelamps will then switch off.

! Switching on the foglamps is prohibited in clear weather or in rain, both day and night. In these situations, the power of their beams may dazzle other drivers. They must only be used in fog or falling snow (rules may vary depending on country). Do not forget to switch off the foglamps when they are no longer necessary.

i **Switching off of the lighting when the ignition is switched off**
When the ignition is switched off, all of the lamps turn off immediately, except for the sidelamps and the dipped beam headlamps if automatic guide-me-home lighting is activated.

i Switching on the lamps after switching off the ignition

To reactivate the lighting control, rotate the ring to the "AUTO" position, then to the desired position.

If the driver's door is opened, a temporary audible signal warns the driver that the lamps are on.

They will go off automatically after a period of time that depends on the level of charge in the battery (entering energy economy mode).

i In some weather conditions (e.g. low temperature or humidity), misting on the internal surface of the glass of the headlamps and rear lamps is normal, and will disappear after the lamps have been on for a few minutes.

! Never look too closely at the light beam of LED technology lamps - risk of serious eye injury!



i Travelling abroad

If planning to use your vehicle in a country that drives on the other side of the road, the dipped beam headlamps must be adjusted to avoid dazzling oncoming drivers. Contact a CITROËN dealer or a qualified workshop.

Daytime running lamps/ Sidelamps

These LED lamps at the front and rear of the vehicle light up automatically when the engine starts.

They perform the following functions:

- Daytime running lamps (lighting control stalk at position "AUTO" with adequate ambient light).
- Sidelamps (lighting control stalk at position "AUTO" with low ambient light or "Sidelamps only" or "Dipped/main beam headlamps").

Direction indicators

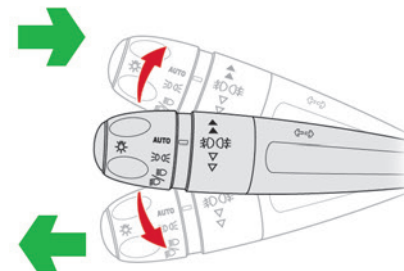

► Left or right: lower or raise the lighting control stalk, beyond the point of resistance.

i If you keep the direction indicators on for more than 20 seconds, the volume of the audible signal will increase if the speed is above 50 mph (80 km/h).

Three flashes

► Press briefly upwards or downwards, without going beyond the point of resistance; the direction indicators will flash 3 times.

Parking lamps

(Depending on version)

Vehicle side marking by lighting the sidelamps on the traffic side only.

► Within one minute after switching off the ignition, operate the lighting control stalk

upwards or downwards, depending on the side of the traffic (e.g. when parking on the right, push the lighting control stalk down to light up on the left).

This is confirmed by an audible signal and the lighting of the corresponding direction indicator lamp on the instrument panel.

► To switch off the parking lamps, return the lighting control stalk to the central position.

Automatic illumination of lamps

With the lighting control stalk in the "AUTO" position and if a low level of exterior brightness is detected by the rain/sunshine sensor, the sidelamps and dipped beam headlamps are switched on automatically, without any action on the part of the driver. They may also come on if rain is detected, at the same time as automatic operation of the windscreen wipers.

As soon as the brightness returns to a sufficient level or after the windscreen wipers are switched off, the lamps are switched off automatically.

Malfunction



In the event of a malfunction of the rain/sunshine sensor, the vehicle's lamps come on and this warning lamp is displayed on the instrument panel, accompanied by an audible signal and/or the display of a message.

Have it checked by a CITROËN dealer or a qualified workshop.

! Do not cover the rain/sunshine sensor located at the top centre of the windscreen behind the interior rear view mirror; the associated functions would no longer be controlled.

i In fog or snow, the rain/sunshine sensor may detect sufficient light. For this reason, the lighting will not come on automatically.

i The inner surface of the windscreen may become misted up and affect the proper operation of the rain/sunshine sensor. In humid and cold weather, demist the windscreen regularly.

Headlamp beam height adjustment

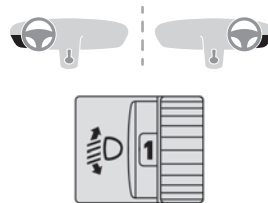

To avoid dazzling other road users, the height of these headlamp beams must be adjusted according to the load in the vehicle.

0 (Initial setting)

Driver only or driver + front passenger

1 5 people

2 5 people + load in the boot

3 Driver only + load in the boot

4 5 6 Not used

Guide-me-home and welcome lighting

Guide-me-home lighting

Automatic

With the ring of the lighting control stalk in the "AUTO" position and when the light is poor, the sidelamps and dipped beam headlamps come on automatically when the ignition is switched off.



You can activate/deactivate this function and adjust the guide-me-home lighting duration in the **Driving/Vehicle** touch screen menu.

Manual

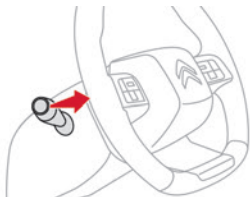

► With the ignition off, pull the lighting control stalk toward you ("headlamp flash") to activate/deactivate the function.

Manual guide-me-home lighting goes off automatically after a period of time.

Welcome lighting

When the vehicle is unlocked, if the ambient light is low and the "Automatic illumination of headlamps" function is activated, this system automatically turns on certain exterior lamps as well as certain lamps in the passenger compartment.



You can activate/deactivate this function and adjust the welcome lighting duration in the **Driving / Vehicle** touch screen tablet menu.

Door mirror spotlamps

These spotlamps facilitate access to the vehicle by lighting the ground near the front doors.



When the front courtesy lamp switch is in this position, the spotlamps come on automatically:

- when the vehicle is unlocked.
 - when a door is opened.
 - when a request to locate the vehicle is received from the remote control.
- Whatever the position of the front courtesy lamp switch, they also come on with the welcome lighting and guide-me-home lighting functions. They go off automatically after 30 seconds.

Automatic lighting systems - General recommendations

The automatic lighting systems use a detection camera, located at the top of the windscreen.

Operating limits

The system may be disrupted or not work correctly:

- When visibility conditions are poor (e.g. snowfall, heavy rain).
- If the windscreen is dirty, misted-up or masked (e.g. sticker) in front of the camera.
- If the vehicle is facing highly reflective signs or safety barrier reflectors.

The system is not able to detect:

- Road users that do not have their own lighting, such as pedestrians.
- Vehicles with hidden lighting (e.g. travelling behind a safety barrier on the motorway).
- Vehicles at the top or bottom of a steep slope, on winding roads, on crossroads.

! Maintenance

Clean the windscreen regularly, particularly the area in front of the camera. The internal surface of the windscreen can also become misted around the camera. In humid and cold weather, demist the windscreen regularly. Do not allow snow to accumulate on the bonnet or roof of the vehicle as this could obstruct the camera.

Automatic headlamp dipping

! For more information, refer to the **General recommendations for automatic lighting systems.**

With the ring of the lighting control stalk in the "AUTO" position and the function activated on the touch screen, this system automatically switches between dipped and main beam headlamps, according to lighting and traffic conditions, using a camera located at the top of the windscreen.

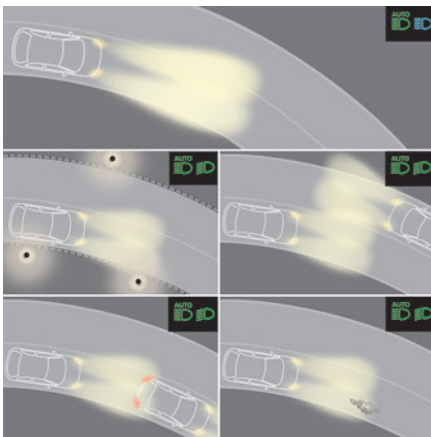

! This system is a driving aid.

The driver remains responsible for the vehicle's lighting, its correct use in the prevailing light, visibility and traffic conditions, and for compliance with driving and vehicle regulations.

i The system becomes operational when the vehicle exceeds 16 mph (25 km/h). When the speed falls below 9 mph (15 km/h), the function is no longer operational.

Activation/Deactivation



It is set via the **Driving / Vehicle** touch screen menu.

The state of the system stays in the memory when switching off the ignition.

Operation

If the ambient light level is very low and traffic conditions permit:



– The main beam headlamps come on automatically. These indicator lamps light up on the instrument panel. If the ambient light level is sufficient and/or the traffic conditions do not allow the main beam headlamps to be lit:



– The dipped beam headlamps remain lit. These indicator lamps light up on the instrument panel.

The function is deactivated if the foglamps are switched on or if the system detects poor visibility conditions (e.g. fog, heavy rain, snowfall).

When the foglamps are switched off or when the visibility conditions become favourable again, the function is automatically reactivated.



This indicator lamp goes out when the function is deactivated.

Pause

If the situation requires a change of headlamp beam, the driver can take over at any time.

► Switch the headlamps manually between dipped and main beam to pause the function. If the "AUTO" and "Dipped beam" indicator lamps were on, the system changes to main beam.

If the "AUTO" and "Main beam" indicator lamps were on, the system changes to dipped beam.

► To reactivate the function, once again switch the headlamps manually between dipped and main beam.

Malfunction



If a malfunction occurs with the system or the camera, this warning lamp lights up on the instrument panel, accompanied by an audible signal and a message. Have it checked by a CITROËN dealer or a qualified workshop.

Cornering lighting

This system makes use of the beam from a front foglamp to illuminate the inside of a bend, when the main or dipped beam headlamps are on and the vehicle speed is below 25 mph (40 km/h) (urban driving, winding road, junctions, parking manoeuvres).

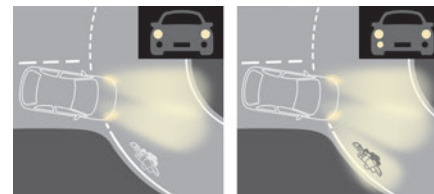

Without/With cornering lighting

Activation / Deactivation



It is set via the **Driving / Vehicle** touch screen menu.

Switching on/off

This system starts:

- when the corresponding direction indicator is switched on.

or

- from a certain angle of rotation of the steering wheel.

It becomes inactive:

- below a certain angle of rotation of the steering wheel.

- above approximately 25 mph (40 km/h).

- when reverse gear is engaged.

Wiper control stalk

i Before operating the wipers in wintry conditions, clear any snow, ice or frost from the windscreen and around the wiper arms and blades.

! Do not operate the wipers on a dry windscreen. In extremely hot or cold weather, check that the wiper blades are not stuck to the windscreen before operating the wipers.

i After using an automatic car wash, you may temporarily notice abnormal noises

and poorer wiping performance. You do not need to replace the wiper blades.

With intermittent wipers

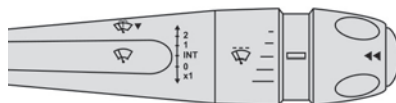

With automatic Wipers

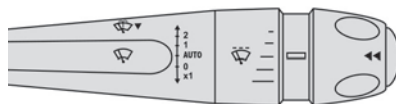

Windscreen wipers

▶ To select the wiping speed: raise or lower the stalk to the desired position.

- 2** Fast wiping (heavy rain)
- 1** Normal wiping (moderate rain)
- Int** Intermittent wipers

or

- AUTO** Automatic wipers
- 0** Switching off
- x 1** Manual

i In position **1** or **2**, the wiping frequency is automatically reduced when the speed of the vehicle drops below 3 mph (5 km/h). When the speed is above 6 mph (10 km/h) again, the wiping frequency returns to the original frequency (fast or normal).

Single wipe

▶ Press and release the control stalk or briefly pull the control stalk towards you.

Windscreen wash

▶ Pull the wiper control stalk towards you and hold.

A final wiping cycle is performed when screenwashing ends.

i With automatic air conditioning, any action on the screenwash control results in temporary closure of the air intake to protect the passenger compartment from any odour.

! To avoid damaging the wiper blades, do not operate the screenwash if the screenwash reservoir is empty. Only operate the screenwash if there is no risk of the fluid freezing on the windscreen and hindering visibility. During the winter period, use "very cold climate" rated products. Never top up with water.

Front intermittent wiping

In Intermittent mode, the driver can adjust the wiping frequency by turning the ring to one of the 5 available positions.

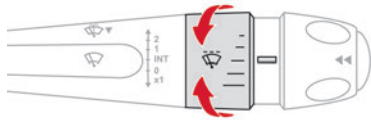

The first (upper) position corresponds to the longest time interval between 2 wipes for light rain.

The last (lower) position corresponds to the shortest time interval between 2 wipes for heavy rain.

A rotation of the ring from a higher position to a lower position triggers a confirmation wiping.

i After the ignition has been switched off for more than 1 minute with the wiper

control stalk in the **INT**, **1** or **2** position, when the ignition is switched on again:

- the system works as soon as the vehicle exceeds 6 mph (10 km/h), if the outside temperature is below +3°C.
- the system works immediately, if the outside temperature is above +3°C.

Automatic windscreen wipers

In **AUTO** mode, the front wipers work automatically and adapt to the intensity of precipitation depending on the sensitivity of the sensor selected.

The rainfall detection function uses a rain/sunshine sensor located at the top centre of the windscreen, behind the rear view mirror.

i In certain weather conditions (e.g. fog, frost, snow, projections on salty roads), the driver may have to return to manual wiping.

Switching on/off

To switch on:

- ▶ Put the wiper control stalk in the **AUTO** position.
- ▶ Turn the ring to adjust the sensitivity of the sensor.

A wiping cycle, accompanied by the display of a message, confirms that the request has been taken into account.

- ▶ To switch off, put the wiper control stalk in another position or in the **0** position.

Adjusting the sensitivity

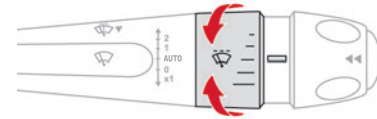

The first position (upper) corresponds to the lowest sensitivity of the sensor.

The last position (lower) corresponds to the highest sensitivity of the sensor.

The higher the sensitivity, the faster the system reacts and increases the wiping frequency.

A rotation of the ring from a higher position to a lower position triggers a confirmation wiping.

i After the ignition has been switched off for more than 1 minute with the wiper control stalk in the **AUTO** position, when the ignition is switched on again:

- the system works, depending on the volume of rain detected, as soon as the vehicle exceeds 6 mph (10 km/h), if the outside temperature is below +3°C.
- the system works immediately, depending on the volume of rain detected, if the outside temperature is above +3°C.

! Do not cover the rain/sunshine sensor.
When using an automatic car wash, switch off the automatic wipers and the ignition.
In winter, wait until the windscreen is completely clear of ice before activating the automatic wipers.

Malfunction

If a fault occurs with the automatic wipers, the wipers operate in intermittent mode.
Have it checked by a CITROËN dealer or a qualified workshop.

Special position of the windscreen wipers

This maintenance position is used while cleaning or replacing the wiper blades. It can also be useful, in wintry weather (ice, snow), to release the wiper blades from the windscreen.

- i** To maintain the effectiveness of the flat wiper blades, it is advisable to:
- handle them with care.
 - clean them regularly using soapy water.
 - avoid using them to hold cardboard on the windscreen.
 - replace them at the first signs of wear.

Before removing a windscreen wiper blade

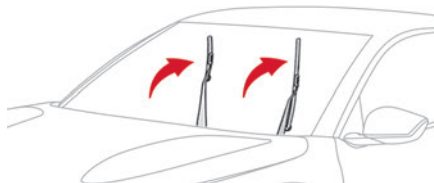

Operating the wiper control stalk immediately after switching off the ignition will place the wiper blades in a vertical position.

- ▶ Proceed with the desired operation or the replacement of the wiper blades.

After refitting a windscreen wiper blade

- ▶ To return the wiper blades to their initial position after the operation, switch on the ignition and operate the wiper control stalk.

Changing a wiper blade

Removing/Refitting at the front

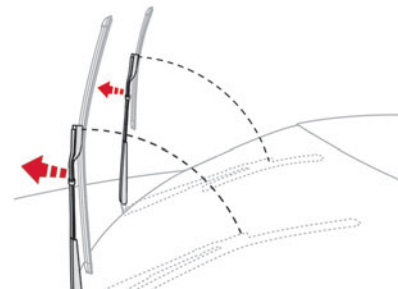

- ▶ Carry out these wiper blade replacement operations from the driver's side.
- ▶ Starting with the wiper blade farthest from you, hold each arm by the rigid section and raise it as far as possible.

! Do not touch the wiper blades - risk of irreparable deformation.
Do not release them while moving them. Risk of damaging the windscreen!

- ▶ Clean the windscreen using screenwash fluid.

i Do not apply "Rain X" type water-repellent products.

- ▶ Unclip the worn wiper blade closest to you and remove it.

- ▶ Install the new wiper blade and clip it to the arm.
- ▶ Repeat the procedure for the other wiper blade.
- ▶ Starting with the wiper blade closest to you, once again hold each arm by the rigid section, then guide it carefully onto the windscreen.

General safety recommendations

! Do not remove the labels attached in different places on your vehicle. They include safety warnings as well as identification information for the vehicle.

! For all work on your vehicle, use a qualified workshop that has the technical information, skills and equipment required, all of which a CITROËN dealer is able to provide.

! Depending on country regulations, certain safety equipment may be mandatory: high visibility safety vests, warning triangles, breathalysers, spare bulbs, spare fuses, fire extinguisher, first aid kit, mud flaps at the rear of the vehicle, etc.

! **Installing electrical accessories:**

- The fitting of electrical equipment or accessories not approved by CITROËN may cause excessive current consumption and faults and failures with the electrical system of your vehicle. Contact a CITROËN dealer for information on the range of approved accessories.
- As a safety measure, access to the diagnostic socket, used for the vehicle's electronic systems, is reserved strictly for

CITROËN dealers or qualified workshops, equipped with the special tools required (risk of malfunctions of the vehicle's electronic systems that could cause breakdowns or serious accidents). The Manufacturer cannot be held responsible if this advice is not followed.

– Any modification or adaptation not intended or authorised by CITROËN or carried out without meeting the technical requirements defined by the Manufacturer will result in the suspension of the commercial warranty.

! Installation of accessory radio communication transmitters

Before installing a radio communication transmitter with an external aerial, you must without fail contact a CITROËN dealer for the specification of transmitters which can be fitted (frequency, maximum power, aerial position, specific installation requirements), in line with the Vehicle Electromagnetic Compatibility Directive (2004/104/EC).

i Declarations of conformity for radio equipment

The relevant certificates are available on the <http://service.citroen.com/ACddb/> website.

Hazard warning lamps



► Pressing this red button causes all the direction indicators to flash. They can work with the ignition switched off.

Automatic operation of hazard warning lamps

When braking in an emergency, depending on the rate of deceleration, the hazard warning lamps come on automatically. They switch off automatically when you next accelerate. They can be turned off by pressing the button again.

Horn



- ▶ Press the central part of the steering wheel.

Pedestrian horn (Electric)

This system alerts pedestrians that the vehicle is approaching.

The pedestrian horn operates once the vehicle is moving and at speeds of up to 19 mph (30 km/h), in forward or reverse gear. This function cannot be deactivated.

Malfunction



In the event of a malfunction, this warning lamp comes on on the instrument panel.

Have it checked by a CITROËN dealer or a qualified workshop.

Emergency or assistance call

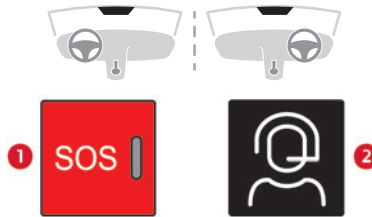

1. eCall (SOS)
2. ASSISTANCE

eCall (SOS)

Your vehicle may be fitted with the eCall (SOS) system either as standard or as an option.

The eCall (SOS) system provides direct contact to the emergency services and is fully built into the vehicle. This contact is made either automatically via the sensors built into the vehicle, or by pressing button 1.

According to the country of sale, the eCall (SOS) system corresponds to the systems PE112, ERAGLONASS, 999, etc.

The eCall (SOS) system is activated by default.

- ▶ To make an emergency call manually, press button 1 for more than 2 seconds.

The lit indicator lamp and a voice message confirm that the call has been made to the emergency services*.

The eCall (SOS) system immediately locates your vehicle and puts you in contact with the appropriate emergency services**.

- ▶ Pressing again immediately cancels the request.

The indicator lamp flashes while the vehicle data is being sent, and then remains lit when communication is established.

! In the event that a serious accident is detected by the sensors built into the vehicle, such as the airbag control unit, an emergency call is made automatically.

i The eCall (SOS) system is a public service of general interest and is free-of-charge.

Operation of the system

- Upon switching on the ignition, the indicator lamp lights up red, then green, and then goes out: the system is operating correctly.

* In accordance with the general conditions of use of the service, available from dealers and subject to technological and technical limitations.

** Depending on the geographic coverage provided by the "eCall (SOS)" and "ASSISTANCE" systems.

The list of countries covered and the telematic services provided is available from dealers or on the website for your country.

- The indicator lamp flashes red: replace the back-up battery.
 - The indicator lamp is fixed red: system malfunction. The emergency and assistance call services may not work.
 - If the indicator lamp does not come on when the ignition is switched on, this also means that there is a system malfunction.
- If the problem persists, contact a qualified workshop as soon as possible.

i A system fault does not prevent the vehicle from being driven.

i Data processing

All processing of personal data by the eCall (SOS) function complies with the framework for protection of personal information established by Regulation 2016/679 (General Data Protection Regulation - GDPR) and Directive 2002/58/EC of the European Parliament and the Council, and in particular, seeks to protect the vital interests of the data subject, in accordance with Article 6 (1) d) GDPR. The processing of personal data is strictly limited to the purpose of handling the eCall (SOS) function used with the "112" single European emergency call number.

The eCall (SOS) function is only able to collect and process the following data relating to the vehicle: vehicle identification number, vehicle type (passenger vehicle or light commercial vehicle), fuel type or power source, three most recent locations and direction of travel, number of passengers and a timestamped log file of the automatic activation of the system and its timestamp. The recipients of the processed data are the emergency call handling centres designated by the relevant national authorities in the territory in which they are located, enabling priority routing and handling of calls to the "112" emergency number.

i Data storage

Data contained in the system's memory is not accessible from outside the system until a call is made. The system is not traceable and is not continuously monitored in its normal operating mode.

The data in the system's internal memory is automatically and continuously erased. Only the vehicle's three most recent locations, necessary for the normal functioning of the system, are stored.

When an emergency call is triggered, the data log is stored for no more than 13 hours.

i Access to data

You have the right of access to data and as appropriate to request the rectification, erasure or restriction of processing of any personal data not processed in accordance with the provisions of GDPR. Third parties to which data has been disclosed shall be notified of any rectification, erasure or restriction carried out in compliance with GDPR, unless it proves impossible or involves a disproportionate effort. You also have the right to lodge a complaint with the respective data protection supervisory authority. If you want to claim your above-mentioned rights please contact us per email at: privacyrights@stellantis.com. For more information regarding our contact details please take a look at our Privacy & Cookies Policy on the brand's website.

ASSISTANCE

- ▶ If the vehicle breaks down, press button **2** for more than 2 seconds to request assistance (confirmed by a voice message*).
- ▶ Pressing again immediately cancels the request.

* Depending on the geographic coverage of the "eCall (SOS)" and "ASSISTANCE" systems and the official national language chosen by the owner of the vehicle.

The list of countries covered and the telematic services provided is available from dealers or on the website for your country.

i Privacy mode allows you to manage the level of sharing (data and/or location) between your vehicle and CITROËN. It can be configured in the **Settings** touch screen menu.

By default, depending on equipment, deactivate/reactivate geolocation by simultaneously pressing the 2 buttons, then press the "ASSISTANCE" button to confirm.

i If you purchased your vehicle outside the CITROËN dealer network, we invite you to have a dealer check the configuration of these services and, if desired, modify them to suit your wishes. In a multilingual country, configuration is possible in the official national language of your choice.

i For technical reasons, in particular to improve the quality of telematic services for customers, the Manufacturer reserves the right to carry out updates to the vehicle's on-board telematic system at any time.

i If you benefit from the Citroën Connect Box offer with the SOS and Assistance Pack included, there are additional services available to you in your personal space, via the website for your country. For information about the SOS and Assistance Pack, please refer to the general conditions for these services.

Electronic stability control (ESC)

The electronic stability control programme includes the following systems:

- Anti-lock braking system (ABS) and Electronic brake force distribution (EBFD).
- Emergency braking assistance (EBA).
- Post Collision Safety Brake (PCSB).
- Anti-slip regulation (ASR).
- Dynamic stability control (DSC).

Anti-lock braking system (ABS)/Electronic brake force distribution (EBFD)

These systems enhance the vehicle's stability and handling during braking, and enable greater control while cornering, particularly on poor or slippery road surfaces.

ABS prevents wheel locking in the event of emergency braking.

Electronic brake force distribution (EBFD) manages overall braking pressure on each individual wheel.

► **When braking in an emergency, depress the pedal very firmly and maintain this pressure.**

i Normal operation of the ABS may make itself felt by slight vibrations of the brake pedal.



The fixed illumination of this warning lamp signals that there is a fault with the ABS.

The vehicle retains conventional braking. Drive carefully at a moderate speed.

Have it checked by a CITROËN dealer or a qualified workshop.



This warning lamp, when lit together with the **STOP** and ABS warning lamps, accompanied by a message and an audible signal, indicates an EBFD malfunction.

You must stop the vehicle.

Stop as soon as it is safe to do so and switch off the ignition.

Contact a CITROËN dealer or a qualified workshop.



When changing wheels (tyres and rims), ensure that these are approved for your vehicle.



After an impact

Have it checked by a CITROËN dealer or a qualified workshop.

Post Collision Safety Brake (PCSB)

If an accident is detected, the vehicle initiates automatic post collision braking. The goal of this system is to reduce the risk of further collisions if the driver does not react.

The system is not operational if the capability of the vehicle is to trigger and execute the

automatic post collision braking is not available, as it can occur in destructive accidents or in other specific accident scenarios. It is possible to override the automatic braking by pressing the brake pedal or accelerator pedal.

Operating conditions

The system operates, if the following conditions are met:

- Airbags or pyrotechnic seat belt pretensioners have been deployed by the collision.
- Braking systems and electric functions remain continuously operational during and after collision.
- Driver has not depressed the brake or accelerator pedal.

Malfunction



In the event of a malfunction, one of these warning lamps will come on fixed on the instrument panel, accompanied by the Service warning lamp, the display of a message and an audible signal.

Have it checked by a CITROËN dealer or a qualified workshop.

Emergency braking assistance (EBA)

This system reduces the emergency stopping distance, by optimising the braking pressure.

It is triggered in relation to the speed at which the brake pedal is depressed. The effect of this is a reduction in the resistance of the pedal and an increase in braking efficiency.

Anti-slip regulation (ASR) / Dynamic stability control (DSC)

Anti-slip regulation (or traction control) optimises traction by using engine braking and by applying the brakes on the driving wheels to avoid one or more wheels spinning. It also enhances the vehicle's directional stability.

If there is a difference between the vehicle's trajectory and the path desired by the driver, the dynamic stability control system automatically uses engine braking and the brakes on one or more wheels to return the vehicle to the desired path, within the limits of the laws of physics. These systems are activated automatically every time the vehicle is started.



These systems are activated in the event of a problem with grip or trajectory (confirmed by this warning lamp flashing on the instrument panel).

Deactivation/Reactivation

In exceptional conditions (starting a vehicle which is bogged down, stuck in snow, on soft ground, etc.), it may be advisable to deactivate the ASR system, so that the wheels can turn freely and regain grip.

Reactivate the system as soon as the level of grip permits.



This function is set via the **Driving/Vehicle** touch screen menu.



Deactivation is confirmed by the lighting of this indicator lamp on the instrument panel and the display of a message.

The ASR system is reactivated automatically every time the ignition is switched off, or at speeds over 31 mph (50 km/h). Reactivation is manual below 31 mph (50 km/h).

Malfunction



In the event of a malfunction, this warning lamp comes on on the instrument panel, accompanied by the display of a message and an audible signal.

Have it checked by a CITROËN dealer or a qualified workshop.

! ASR/DSC

These systems enhance safety during normal driving, but should not encourage the driver to take extra risks or drive at high speed.

It is in conditions of reduced grip (rain, snow, ice) that the risk of loss of grip increases. It is therefore important for your safety to keep these systems activated in all conditions, and particularly in difficult conditions.

Correct operation of these systems depends on compliance with the manufacturer's recommendations relating to the wheels

(tyres and rims), braking and electronic components, as well as the assembly and repair procedures provided by CITROËN dealers.

In order to ensure that these systems remain effective in wintry conditions, the use of snow or all-season tyres is recommended. All four wheels must be fitted with tyres approved for your vehicle.

All tyre specifications are listed on the tyre/paint label. For more information on **Identification markings**, refer to the corresponding section.

Seat belts

Inertia reel

The seat belts are equipped with an inertia reel which allows the strap length to adjust automatically to the shape of the user. The seat belt returns to its storage automatically when it is not used.

The inertia reels are fitted with a device which automatically locks the strap in the event of a collision, emergency braking or if the vehicle rolls over. It can be released by pulling the strap firmly and then releasing it so that it reels in slightly.

Pyrotechnic pretensioning

This system improves safety in the event of a frontal or side impact.

Depending on the severity of the impact, the pyrotechnic pretensioning system instantly

tightens the seat belts against the body of the occupants.

The pyrotechnic pretensioning seat belts are enabled when the ignition is on.

Force limiting system

This system reduces the pressure of the seat belt on the chest of the occupant, thus improving their protection.

! In the event of an impact

Depending on the nature and seriousness of the impacts, the pyrotechnic device may trigger before and independently of airbag deployment. Deployment of the pretensioners is accompanied by a slight discharge of harmless smoke and a noise, due to the activation of the pyrotechnic cartridge incorporated in the system.

In all cases, the airbag warning lamp comes on.

Following an impact, have the seat belt system checked, and if necessary replaced, by a CITROËN dealer or a qualified workshop.

Front seat belts

The front seat belts are fitted with a pyrotechnic pretensioning system and a force limiting system.

Rear seat belts

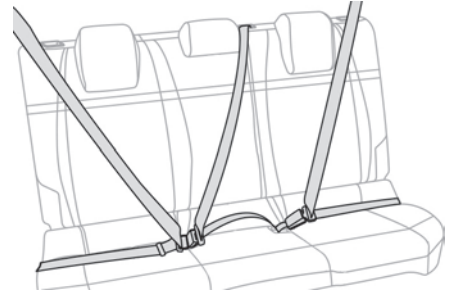

Each of the rear seats has a three-point seat belt with inertia reel.

The outer seats are fitted with a pyrotechnic pretensioning and force limiting system.

Fastening

- ▶ Pull the strap, then insert the tongue into the buckle.
- ▶ Check that the seat belt is fastened correctly by pulling on the strap.

Unfastening

- ▶ Press the red button on the buckle.
- ▶ Guide the seat belt as it is reeled in.

Seat belts warning lamps display

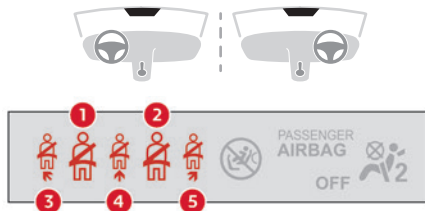

1. Front left seat belt warning lamp
2. Front right seat belt warning lamp
3. Rear left seat belt warning lamp
4. Rear centre seat belt warning lamp
5. Rear right seat belt warning lamp

Not fastened/unfastened warning lamp

It comes on in red on both the instrument panel and on the seat belts warning lamps display as soon as the system detects that a seat belt is not fastened or has been unfastened.

Type 1



Front seat belt not fastened alert

When the ignition is switched on, if the driver or front passenger has not fastened their seat belt, the corresponding warning lamp (1 or 2) comes on in red. At a speed greater than 12 mph (20 km/h), the warning lamp flashes red, accompanied by an audible signal for around 2 minutes. After this time has elapsed, the warning lamp remains on fixed in red until the seat belt is fastened.



Rear seat belt not fastened alert

When the ignition is switched on, if one of the rear passengers has not fastened their seat belt, the corresponding warning lamp (3, 4 or 5) comes on in red for 60 seconds.



Seat belt unfastened alert

After the ignition is switched on, if the driver or a passenger unfastens their seat belt, the corresponding warning lamp (1, 2, 3, 4 or 5) comes on in red. At a speed greater than 12 mph (20 km/h), the warning lamp flashes, accompanied by an audible signal for around 2 minutes. After this time has elapsed, the warning lamp remains on until the seat belt has been fastened again.



With the ignition on, if the driver or a passenger fastens their seat belt, the corresponding warning lamp (1, 2, 3, 4 or 5) comes on in green on the display.



With the ignition on, if one of the front or rear passenger seats is detected as being unoccupied, the corresponding warning lamp (2, 3, 4 or 5) comes on in grey.

When there are no longer any not fastened/unfastened alerts, the green or grey warning lamps remain on for around 30 seconds, then go off.

Type 2



Front seat belt not fastened alert

When the ignition is switched on, if the driver or front passenger has not fastened their seat belt, the corresponding warning lamp (1 or

2) comes on in red. At a speed greater than 12 mph (20 km/h), the warning lamp flashes red, accompanied by an audible signal for around 2 minutes. After this time has elapsed, the warning lamp remains on fixed in red until the seat belt is fastened.



Rear seat belt not fastened alert

When the ignition is switched on, if one of the rear passengers has not fastened their seat belt, the corresponding warning lamp (3, 4 or 5) comes on in red for 60 seconds.



Seat belt unfastened alert

After the ignition is switched on, if the driver or a passenger unfastens their seat belt, the corresponding warning lamp (1, 2, 3, 4 or 5) comes on in red. At a speed greater than 12 mph (20 km/h), the warning lamp flashes, accompanied by an audible signal for around 2 minutes. After this time has elapsed, the warning lamp remains on until the seat belt has been fastened again.

Advice

- ! The driver must ensure that passengers use the seat belts correctly and that they are all fastened before setting off. Wherever seated in the vehicle, you must always fasten the seat belt, even for short journeys. Do not invert the seat belt buckles, as they will not fulfil their role properly.

To ensure the proper functioning of the belt buckles, make sure that there are no foreign bodies present (e.g. a coin) before fastening. Before and after use, ensure that the seat belt is reeled in correctly.

After folding or moving a seat or rear bench seat, ensure that the seat belt is positioned and reeled in correctly.

! Installation

The lower part of the strap must be positioned as low as possible over the pelvis. The upper part must be positioned in the hollow of the shoulder.

In order to be effective, a seat belt must:

- be tightened as close to the body as possible.
- be pulled in front of you with a smooth movement, ensuring that it is not twisted.
- only be used to secure one person.
- not show signs of tearing or fraying.
- not be changed or modified, in order to avoid affecting its performance.

! Recommendations for children

Use a suitable child seat if the passenger is less than 12 years old or shorter than 1.5 metres.

Never use the same seat belt to secure more than one child.

Never carry a child on your lap.

For more information on **Child seats**, refer to the corresponding section.

! Maintenance

In accordance with current safety regulations, for all work on your vehicle's seat belts, contact a qualified workshop with the skills and equipment needed, which a CITROËN dealer is able to provide.

Have the seat belts checked regularly by a CITROËN dealer or a qualified workshop, particularly if the straps show signs of damage.

Clean the seat belt straps with soapy water or a textile cleaning product, sold by CITROËN dealers.

Airbags

General information

System designed to help improve the safety of the occupants sitting in the front seats and the rear outer seats, in the event of a violent collision. The airbags supplement the action of the seat belts equipped with a force limiting system.

Electronic detectors record and analyse the front and side impacts sustained in the impact detection zones:

- In the event of violent impact, the airbags deploy instantly and help better protect the

occupants of the vehicle; immediately after the impact, the airbags deflate rapidly in order not to hinder the visibility or the possible exit of the occupants.

– In the event of a slight impact, a rear impact and under certain rollover conditions, the airbags may not deploy; only the seat belt helps to protect you in these situations.

The seriousness of the impact depends on the nature of the obstacle and the speed of the vehicle at the moment of collision.

! The airbags do not operate when the ignition is switched off.

This equipment will only deploy once. If a second impact occurs (during the same or a subsequent accident), the airbag will not be deployed again.

Impact detection zones

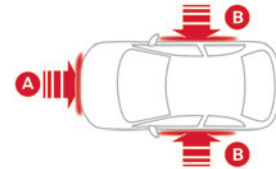

A. Front impact zone

B. Side impact zone

i When one or more airbags are deployed, the detonation of the pyrotechnic charge

incorporated in the system makes a noise and releases a small quantity of smoke. This smoke is not harmful, but sensitive individuals may experience irritation. The detonation noise associated with the deployment of one or more airbags may result in a slight loss of hearing for a short time.

Front airbags

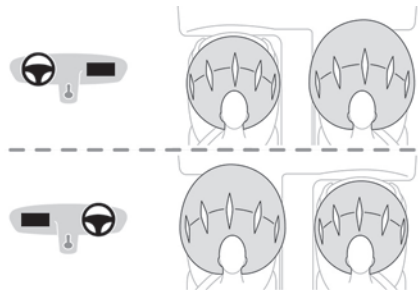

System that protects the driver and front passenger in the event of a serious front impact, limiting the risk of head and chest injury. The driver's airbag is fitted in the centre of the steering wheel; the front passenger airbag is fitted in the dashboard above the glove box.

Deployment

They deploy, except the front passenger airbag if it is deactivated*, in the event of a serious front impact to all or part of the front impact zone **A**. The front airbag inflates between the thorax and head of the front occupant of the vehicle and the steering wheel, driver's side, and the dashboard, passenger's side, to cushion their forward movement.

Lateral airbags

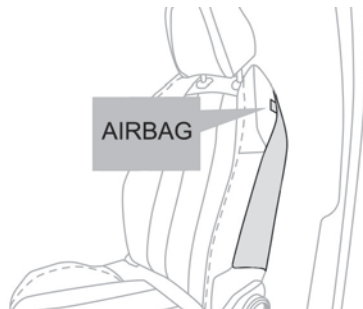

In the event of a serious side impact, this system protects the driver and front passenger to mitigate the risk of injury to the chest, between the hip and the shoulder. Each lateral airbag is fitted in the seat backrest frame, on the door side.

Deployment

The lateral airbags are deployed on one side in the event of a serious side impact applied to all or part of the side impact zone **B**. The lateral airbag inflates between the chest of the vehicle's occupant and the corresponding door panel.

Curtain airbags

System contributing towards greater protection for the driver and passengers (with the exception of the rear centre passenger) in the event of a serious side impact in order to limit the risk of injury to the side of the head. Each curtain airbag is built into the pillars and the upper passenger compartment area.

Deployment

It deploys simultaneously with the corresponding lateral airbag in the event of a serious side impact applied to all or part of the side impact zone **B**. The curtain airbag inflates between the front and rear occupants of the vehicle and the corresponding windows.

Malfunction



In the event of a malfunction, this warning lamp lights up on the instrument panel.

* For more information on Deactivating the front passenger airbag, refer to the corresponding section.

Contact a CITROËN dealer or a qualified workshop to have the system checked. The airbags may not be deployed in the event of a serious impact.

! In the event of a minor impact or bump at the side of the vehicle or if the vehicle rolls over, the airbags may not be deployed. In the event of a rear or front collision, none of the lateral airbags are deployed.

Advice

! **For the airbags to be fully effective, observe the safety recommendations below.**

Adopt a normal and upright sitting position. Fasten your seat belt and position it correctly. Do not place anything between the occupants and the airbags (e.g. child, animal, object), do not fix or attach anything near or in the path of the airbags, as this could cause injuries when they are deployed. Never modify the original definition of the vehicle, particularly in the area directly around the airbags. Even if all of the precautions mentioned are observed, a risk of injury or of minor burns to the head, chest or arms cannot be ruled out when an airbag is deployed. The bag inflates almost instantly (within a few milliseconds) then deflates within the same time,

discharging the hot gas via openings provided for this purpose.

After an accident or if the vehicle has been stolen, have the airbag systems checked. All work must be carried out only by a CITROËN dealer or a qualified workshop

! Front airbags

Do not drive holding the steering wheel by its spokes or resting your hands on the centre part of the wheel. Passengers must not place their feet on the dashboard.

Do not smoke as deployment of the airbags can cause burns or the risk of injury from a cigarette or pipe.

Never remove or pierce the steering wheel or hit it violently.

Do not fix or attach anything to the steering wheel or dashboard, as this could cause injuries when the airbags are deployed.

! Lateral airbags

Use only approved seat covers compatible with the deployment of these airbags. For information on the range of seat covers suitable for your vehicle, contact a CITROËN dealer.

Do not fix or attach anything to the seat backrests (e.g. clothing) as this could cause injuries to the chest or arm when the airbag is deployed.

Do not sit with the upper part of the body any nearer to the door than necessary.

The vehicle's front door panels include side impact sensors.

A damaged door or any unauthorised or incorrectly executed work (modification or repair) on the front doors or their interior trim could compromise the operation of these sensors - risk of malfunction of the lateral airbags!

All work must be carried out only by a CITROËN dealer or a qualified workshop

! Curtain airbags

Do not fix or attach anything to the roof, as this could cause head injuries when the curtain airbag is deployed. Do not remove the grab handles installed on the roof.

Child seats

i The regulations on carrying children are specific to each country. Refer to the legislation in force in your country.

For maximum safety, please observe the following recommendations:

- In accordance with European regulations, **all children under the age of 12 or less than 1,5 metres tall must travel in approved child**

seats suited to their weight, on seats fitted with a seat belt or ISOFIX mountings.

– **Statistically, the safest seats in your vehicle for carrying children are the rear seats.**

– **Children weighing less than 9 kg must travel in the "rearward facing" position, whether in the front or rear of the vehicle.**

I It is recommended that children travel on the **rear seats** of the vehicle:

- 'rearward facing' up to the age of 3,
- 'forward facing' over the age of 3.

! Make sure that the seat belt is correctly positioned and tightened.

For child seats with a support leg, ensure that the support leg is in firm and steady contact with the floor.

Advice

! An incorrectly installed child seat compromises the child's safety in the event of an accident.

Ensure that there is no seat belt or seat belt buckle under the child seat, as this could destabilise it.

Remember to fasten the seat belts or the harness of child seats, keeping the slack relative to the child's body to a minimum, even for short journeys.

When installing a child seat using the seat belt, ensure that the seat belt is tightened correctly on the child seat and that it secures the child seat firmly on the seat of the vehicle. If the passenger seat is adjustable, move it forwards if necessary.

Remove the head restraint before installing a child seat with a backrest on a passenger seat.

Ensure that the head restraint is stored or attached securely to prevent it from being thrown around the vehicle in the event of sharp braking. Refit the head restraint once the child seat has been removed.

! Installing a booster seat

The chest part of the seat belt must be positioned on the child's shoulder without touching the neck.

Ensure that the lap part of the seat belt passes correctly over the child's thighs. Use a booster seat with backrest, equipped with a belt guide at shoulder level.

! Additional protections

To prevent accidental opening of the doors and rear windows, use the "Child lock". Take care not to open the rear windows by more than one third.

To protect young children from the rays of the sun, fit side blinds on the rear windows. As a safety precaution, do not leave:

- a child alone and unattended in a vehicle,
- a child or an animal in a vehicle which is exposed to the sun, with the windows closed,
- the keys within reach of children inside the vehicle.

Child seat at the rear

Forward-facing or rearward-facing



► Move the vehicle's front seat forward and straighten the backrest so that the legs of the child in the forward-facing or rearward-facing child seat itself do not touch the vehicle's front seat.

► Check that the backrest of the forward-facing child seat is as close as possible to the backrest of the vehicle's rear seat, and ideally in contact with it.

Centre rear seat

A child seat with a support leg must never be installed on the **centre rear passenger seat**.

Child seat at the front



► Adjust the front passenger seat to the **highest and fully back longitudinal position, with the backrest straightened.**

"Forward facing"



! You must leave the front passenger airbag active.

"Rearward facing"



! The front passenger airbag must be deactivated before installing a rearward facing child seat. Otherwise, **the child risks being seriously injured or killed if the airbag is deployed.**



Warning label - Front passenger airbag

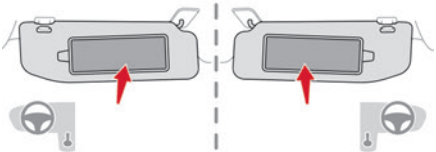

You must comply with the following instruction, as reminded by the warning label on both sides of the passenger sun visor:

NEVER use a rearward facing child restraint on a seat protected by an ACTIVE AIRBAG in front of it, DEATH or SERIOUS INJURY to the CHILD can occur.

Deactivating the front passenger airbag



Passenger airbag OFF

! To ensure the safety of the child, the front passenger airbag **MUST** be deactivated when a "rearward facing" child seat is installed on the front passenger seat. Otherwise, the child risks being seriously injured or killed in the event of deployment of the airbag.

! **Vehicles not equipped with a deactivation/reactivation control**
Installing a "rearward facing" child seat on the front passenger seat is strictly prohibited - risk of death or serious injury in the event of airbag deployment!

Deactivating/Reactivating the front passenger airbag

For vehicles on which it is fitted, the switch is located on the side of the dashboard or inside the glove box.

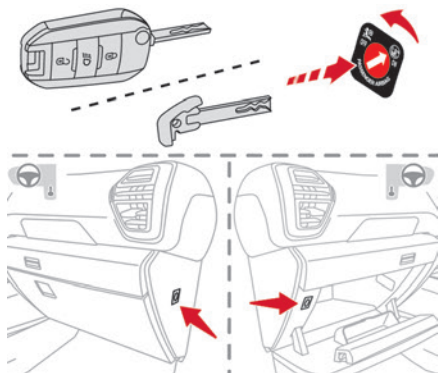

With the ignition off:

- ▶ To deactivate the airbag, turn the key in the switch to the "OFF" position.
- ▶ To reactivate it, turn the key to the "ON" position.

When the ignition is switched on:

 This warning lamp comes on and remains lit to signal deactivation.

Or

 This warning lamp comes on for about 1 minute to signal activation.

Recommended child seats

Range of child seats secured using a **three-point seat belt**.

Group 0+: from birth to 13 kg



L1

"RÖMER Baby-Safe"

Installed in the "rearward facing" position.

Groups 2 and 3: from 15 to 36 kg



L5

"RÖMER KIDFIX 2R"

Can be fitted to the vehicle's ISOFIX mountings.

The child is restrained by the seat belt.
Only suitable for installation on the side rear seats.

The head restraint on the vehicle seat must be removed.

Groups 2 and 3: from 15 to 36 kg



L6

"GRACO Booster"

The child is restrained by the seat belt.
Only suitable for installation on the front passenger seat or on the rear side seats.

"ISOFIX" mountings

The seats shown below are fitted with ISOFIX compliant mountings:

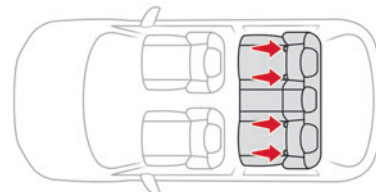

The mountings comprise three rings for each seat, indicated by a marking:

- Two rings **A**, located between the vehicle seat backrest and cushion.

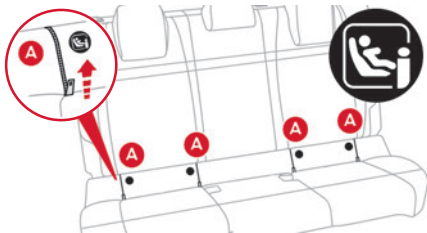

These rings are located behind zips.

The 2 latches on **ISOFIX child seats** are secured to them.

– One ring **B**, located behind the seat, called the **TOP TETHER**, for attaching seats fitted with an upper strap.

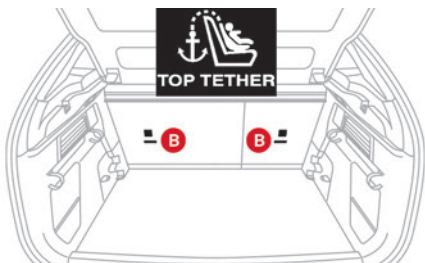

This system prevents the child seat from tipping forwards in the event of a front impact.

This ISOFIX mounting system provides fast, reliable and safe fitting of the child seat in the vehicle.

To secure the child seat to the **TOP TETHER**:

- ▶ Remove and stow the head restraint before installing the child seat on this seat (refit it once the child seat has been removed).
- ▶ Pass the strap of the child seat behind the seat backrest, centring it between the openings for the head restraint rods.
- ▶ Secure the upper strap hook to ring **B**.
- ▶ Tighten the upper strap.

i When fitting an ISOFIX child seat to the left-hand rear seat of the bench seat, before fitting the seat, first move the centre rear seat belt towards the middle of the vehicle, so as to avoid the seat interfering with the operation of the seat belt.

! An incorrectly installed child seat in a vehicle compromises the child's safety in the event of an accident. Strictly observe the fitting instructions provided in the user guide supplied with the child seat.

i For information about the options for fitting ISOFIX child seats in your vehicle, refer to the summary table.

Recommended ISOFIX child seats

i Also consult the user guide from the child seat's manufacturer to find out how to install and remove the seat.

"RÖMER Baby-Safe and its ISOFIX base" (size category: E)

Group 0+: from birth to 13 kg



Installed "rearward facing" using an ISOFIX base which is attached to rings **A**. The base has a support leg, height-adjustable, which rests on the vehicle's floor. This child seat can also be secured with a seat belt. In this case, only the shell is used and attached to the vehicle seat using the three-point seat belt.

"RÖMER Duo Plus ISOFIX" (size category: B1)

Group 1: from 9 to 18 kg



"RÖMER Duo Plus ISOFIX"(size category: **B1**)**Group 1: from 9 to 18 kg**

Suitable for forward-facing installation only.
Attached to rings **A** and ring **B**, referred to as
TOP TETHER, using an upper strap.

Three seat body angles: sitting, reclining,
lying down.

This child seat can also be used in seat
positions not equipped with ISOFIX
mountings. In this case, it must be secured to
the vehicle's seat by the three-point seat belt.
Adjust the front seat of the vehicle so that the
child's feet do not touch the backrest.

i-Size child seats

i-Size child seats have two latches that are anchored to the two rings **A**.

These i-Size child seats also have:



- either an upper strap that is attached to ring **B**.
- or a support leg that rests on the vehicle floor, compatible with the approved i-Size seat position.

Their role is to prevent the child seat from tipping forward in the event of a collision.

For more information on the **ISOFIX mountings**, refer to the corresponding section.

Installing universal, ISOFIX and i-Size child seats

In compliance with European regulations, this table indicates the possibilities for installing child seats secured using the seat belt and universally approved (a) as well as the largest ISOFIX and i-Size child seats for the seat positions fitted with ISOFIX anchorage points in the vehicle.

	Seat number					
	Front seats (j)			Rear seats (j)		
	1	3		4	5	6
	3	1		4	5	6
Front passenger airbag		Deactivated "OFF" (b)	Activated "ON" (c)			
Position compatible with a universal (a) child seat	no	yes (d) (h)	yes (d) (i)	yes	yes (e)	yes
Position compatible with an i-Size child seat	no	no (f)		yes	no (f)	yes
Position equipped with a TOP TETHER hook	no	no (f)		yes	no (f)	yes
" Carrycot " type child seat	no	no (f)		no		
"Rearward facing" ISOFIX child seat	no	no (f)		R3 (g)	no (f)	R3 (g)
"Forward facing" ISOFIX child seat	no	no (f)		F3 (g)	no (f)	F3 (g)
Booster child seat	no	B3 (f) (k)		B3 (g)	B3 (f)	B3 (g)

Rules:

– A position that is **i-Size** compatible is also compatible with **R1, R2 and F2X, F2, B2**.

– A position that is **R3** compatible is also compatible for **R1** and **R2**.

– A position that is **F3** compatible is also compatible for **F2X** and **F2**.

– A position that is **B3** compatible is also compatible with **B2**.

(a) Universal child seat: child seat that can be installed in all vehicles using the seat belt.

(b) To install a **"rearward facing"** child seat at this seat position, the front passenger airbag must be deactivated ("**OFF**").

(c) Only a **"forward facing"** child seat is authorised at this seat position with the front passenger airbag activated ("**ON**").

(d) For a seat with height adjustment, adjust the seat to the highest position and move it fully back, with the backrest straightened.
For a seat without height adjustment, move the seat fully back, with the backrest straightened.

(e) Never install a child seat with a support leg on the centre rear seat.

(f) Seats not fitted with "ISOFIX" mountings.

(g) Adjust the front passenger seat to the middle longitudinal position with the backrest straightened.

(h) For a "rearward facing" and/or "forward facing" universal child seat (U) in groups 0, 0+, 1, 2 or 3.

(i) For a "forward facing" universal child seat (UF) in groups 1, 2 or 3.

(j) Depending on version, refer to the legislation in force in your country before installing a child in this seat position.

(k) Adjust the front passenger seat to the fully backward position.

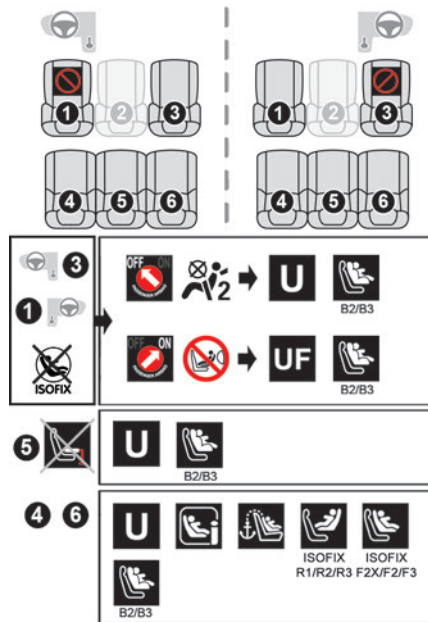

and **universally approved "rearward facing" and/or "forward facing" (U)** for all sizes and weight groups.

UF Seat position suitable for the installation of a child seat secured using the seat belt and **universally approved "forward facing" (UF)** for groups **1, 2 & 3** only.



Seat position authorised for the installation of an **i-Size** child seat.



Seat position not suitable for the installation of a child seat with support leg.



Presence of a **Top Tether** anchorage point at the rear of the backrest, authorising the installation of a **universal ISOFIX child seat**.



"Rearward facing" **ISOFIX** child seat:

- **R1: ISOFIX** child seat for a **baby**.
- **R2: ISOFIX reduced size** child seat.
- **R3: ISOFIX large size** child seat.



"Forward facing" **ISOFIX** child seat:

- **F2X: ISOFIX** child seat **for toddlers**.
- **F2: ISOFIX reduced height** child seat.
- **F3: ISOFIX full height** child seat.



Booster child seat:

- **B2: reduced width booster** seat.
- **B3: full width booster** seat.



Seat position where the installation of an **ISOFIX** child seat is forbidden.

For seat adjustments, refer to the table **"Installing universal, ISOFIX and i-Size child seats"**.

Manual child lock

The system prevents a rear door from being opened using its interior handle. The control is located on the edge of each rear door (marked by a label on the bodywork).

Activation/Deactivation

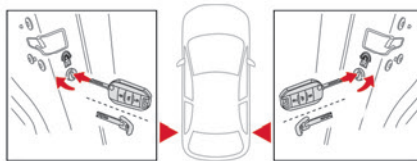

- ▶ To activate, turn the built-in key fully:
 - To the right on the left-hand rear door.
 - To the left on the right-hand rear door.
- ▶ To deactivate, turn it in the opposite direction.

Driving recommendations

- ▶ Observe the driving regulations and remain vigilant whatever the traffic conditions.
- ▶ Monitor your environment and keep your hands on the wheel to be able to react to anything that may happen any time.
- ▶ Drive smoothly, anticipate the need for braking and maintain a longer safety distance, especially in bad weather.
- ▶ Stop the vehicle before performing operations that require sustained attention (e.g. settings).
- ▶ During long trips, take a break every 2 hours.

Important!

! Never leave the engine running in a closed space without sufficient ventilation. Internal combustion engines emit toxic exhaust gases such as carbon monoxide. Danger of poisoning and death!

! In very severe wintry conditions (temperature below -23°C), let the engine run for 4 minutes before moving off, to ensure the correct operation and durability of the mechanical components of your vehicle (engine and gearbox).

! Never drive with the parking brake applied. Risk of overheating and damaging the braking system!

! Never park the vehicle and never leave the engine running on a flammable surface (e.g. dry grass, dead leaves). The vehicle exhaust system is very hot, even several minutes after the engine stops. Risk of fire!

! Never drive on surfaces covered with vegetation (e.g. tall grass, accumulated dead leaves, crops, debris) such as a field, a country lane overgrown with bushes or a grassy verge. This vegetation could come into contact with the vehicle's exhaust system or other systems which are very hot. Risk of fire!

! Make sure you do not leave any item in the passenger compartment which could act like a magnifying glass under the effect of the sun's rays and cause a fire. Risk of fire or damage to interior surfaces!

! Never leave the vehicle unattended, with the engine running. If you have to leave your vehicle with the engine running, apply the parking brake and put the gearbox into neutral or position **N** or **P** (depending on the type of gearbox).

! Never leave children inside the vehicle unsupervised.

On flooded roads

We strongly advise against driving on flooded roads, as this could cause serious damage to the engine or gearbox, as well as to your vehicle's electrical systems.



If the vehicle absolutely must drive through a flooded section of road:

- ▶ Check that the depth of the water does not exceed 15 cm, taking account of waves that might be generated by other users.
 - ▶ Deactivate the Stop & Start function.
 - ▶ Drive as slowly as possible without stalling. In all cases, do not exceed 6 mph (10 km/h).
 - ▶ Do not stop and do not switch off the engine.
- On leaving the flooded road, as soon as safety conditions allow, make several light brake applications to dry the brake discs and pads. If in doubt about the state of your vehicle, contact a CITROËN dealer or a qualified workshop.

Noise (Electric)

On the outside

Due to the vehicle's quiet operation when driving, the driver must pay particular attention. When manoeuvring, the driver must always check the vehicle's immediate surroundings. At speeds of up to 19 mph (30 km/h), the pedestrian horn warns other road users of the vehicle's presence.

Cooling the traction battery

The cooling fan comes on during charging to cool the on-board charger and the traction battery.

On the inside

During use, you may hear certain perfectly normal noises specific to electric vehicles, such as:

- Traction battery relay when starting.
- Vacuum pump when braking.
- Vehicle tyres or aerodynamics when driving.
- Jolting and knocking noise during hill starts.

Towing

 Driving with a trailer places greater demands on the towing vehicle and particular care must be taken.

 Do not exceed the maximum towable weights.

At altitude: reduce the maximum load by 10% per 1,000 metres of altitude; the lower air density at high altitudes decreases engine performance.

 **New vehicle:** do not tow a trailer until the vehicle has driven at least 620 miles (1,000 kilometres).

 If the outside temperature is high, let the engine idle for 1 to 2 minutes after the vehicle comes to a stop, to help it to cool.

Before setting off

Nose weight

► Distribute the load in the trailer so that the heaviest items are as close as possible to the axle and the nose weight (at the point where it joins your vehicle) approaches the maximum permitted without exceeding it.

Tyres

► Check the tyre pressures of the towing vehicle and of the trailer, observing the recommended pressures.

Lighting

► Check the electrical signalling on the trailer and the headlamp beam height of your vehicle.

 If a genuine CITROËN towing device is used, the rear parking sensors will be deactivated automatically to avoid the audible signal.

When driving

Cooling

Towing a trailer uphill causes the coolant temperature to increase. The maximum towable load depends on the gradient and the exterior temperature. The fan's cooling capacity does not increase with engine speed.

- Reduce speed and lower the engine speed to limit the amount of heating produced.
- Pay constant attention to the coolant temperature.



If this warning lamp and the **STOP** warning lamp come on, stop the vehicle and switch off the engine as soon as possible.

Brakes

Using the engine brake is recommended to limit the overheating of the brakes. Braking distances are increased when towing a trailer.

Side wind

Bear in mind that the vehicle will be more susceptible to wind when towing.

Anti-theft protection

Electronic immobiliser

The keys contain a code, which must be recognised by the vehicle before starting is possible.

If the system malfunctions, indicated by the display of a message, the engine will not start. Contact a CITROËN dealer.

Starting / Switching off the engine with the key

Key ignition switch

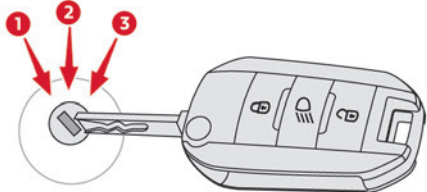

It has 3 positions:

- **1. Stop:** inserting and removing the key, steering column locked.
- **2. Ignition:** steering column unlocked, ignition on, Diesel preheating, engine running.
- **3. Starting.**

i Avoid attaching heavy objects to the key or the remote control. It would weigh

down on its shaft in the ignition switch and could cause a malfunction.

Ignition on position

It allows the use of the vehicle's electric equipment or the charging of accessories. Once the state of charge of the battery drops to the reserve level, the system switches to energy economy mode: the power supply is cut off automatically to preserve the remaining battery charge.

Starting the engine

With the parking brake applied:

- ▶ With a **manual gearbox**, place the gear lever in neutral then fully depress the clutch pedal.
- ▶ With an **automatic gearbox**, place the gear selector in mode **N** or **P** then depress the brake pedal.
- ▶ Insert the key into the ignition switch; the system recognises the code.
- ▶ Unlock the steering column by simultaneously turning the steering wheel and the key.

i In certain cases, you may need to apply significant force to move the steering wheel (e.g. wheels turned to full lock).

- ▶ With a **petrol engine**, operate the starter motor by turning the key to position **3** without pressing the accelerator pedal, until the engine starts. Once the engine has started, release the key and allow it to return to position **2**.

i Petrol engines

After a cold start, preheating the catalytic converter can cause noticeable engine vibrations, for anything up to 2 minutes (accelerated idle speed).

- ▶ With a **Diesel engine**, turn the key to position **2**, to activate the engine preheating system.

⌘ Wait until this warning lamp goes off on the instrument panel, then turn the key to position **3** without pressing the accelerator pedal, to operate the starter motor. Once the engine has started, release the key and allow it to return to position **2**.

i In wintry conditions, the warning lamp may stay on for a longer period. When the engine is hot, the warning lamp does not come on. In mild conditions, do not leave the engine to warm up while stationary, but move off straight away and drive at moderate speed.

! If the engine does not start straight away, switch off the ignition. Wait a few seconds before operating the starter motor again. If the engine does not start after a few attempts, do not keep trying - risk of damaging the starter motor and the engine! Contact a CITROËN dealer or a qualified workshop.

Switching off the engine

- ▶ Immobilise the vehicle.
- ▶ With the engine at idle, turn the key to position **1**.
- ▶ Remove the key from the ignition switch.
- ▶ To lock the steering column, turn the steering wheel until it locks.

i To facilitate unlocking of the steering column, it is recommended that the wheels be returned to the straight ahead position before switching off the engine.

! Never switch off the ignition before the complete immobilisation of the vehicle. With the engine off, the braking and steering assistance systems are also cut off - risk of loss of control of the vehicle!

i Check that the parking brake is correctly applied, particularly on sloping ground. When leaving the vehicle, keep the key in your possession and lock the vehicle.

Energy economy mode

After the engine has stopped (position **1. Stop**), for a maximum combined duration of 30 minutes, you can still use functions such as the audio and telematics system, courtesy lamps or dipped beam headlamps.

i For more information on **Energy economy mode**, refer to the corresponding section.

i **Key left in**
When the driver's door is opened, a message is displayed, accompanied by an audible signal, if the key has been left in the ignition switch in position **1**. If the key has been left in the ignition switch in position **2**, the ignition will be switched off automatically after one hour. To switch the ignition back on, turn the key to position **1**, then back to position **2**.

Starting/switching off the engine with Keyless Entry and Start

i The electronic key must be present in the passenger compartment.

The electronic key is also detected in the boot.

If the electronic key is not detected, a message is displayed.

Move the electronic key so that the engine can be started or switched off.

If there is still a problem, refer to the "Key not detected - Back-up starting or Back-up switch-off" section.

Starting



- ▶ With a **manual gearbox**, place the gear lever in neutral and fully depress the clutch pedal.
- ▶ With an **automatic gearbox**, select mode **P** or **N** and press the brake pedal.
- ▶ Press the **"START/STOP"** button while maintaining pressure on the pedal until the engine starts.

Diesel engines

In negative temperatures and/or when the engine is cold, starting takes place only after the preheating warning lamp goes out.

 If this warning lamp comes on after pressing the **"START/STOP"** button:

- ▶ Keep the pedal fully depressed and do not press the **"START/STOP"** button again until the engine is running.

In all circumstances, if one of the starting conditions is not met, a message is displayed. In some circumstances, a message indicates that it is necessary to turn the steering wheel

while pressing the **"START/STOP"** button to assist unlocking of the steering column.

i Petrol engines

With Petrol engines, after a cold start, pre-heating the catalytic converter can cause noticeable engine vibrations, for anything up to 2 minutes (accelerated idle speed).

i If the engine stalls, release the clutch pedal and fully depress it again, the engine will restart automatically.

Switching off

- ▶ Immobilise the vehicle using the parking brake.
- ▶ With a **manual gearbox**, ideally put the gear lever into neutral.
- ▶ With an **automatic gearbox**, ideally select mode **P** or **N**.
- ▶ Press the **"START/STOP"** button.

In some circumstances, it is necessary to turn the steering wheel to lock the steering column. On certain versions with an automatic gearbox (EAT8), the steering column does not lock, but the gearbox locks in mode **P**.

i If the vehicle is not immobilised, the engine will not stop.

! With the engine off, the braking and steering assistance systems are also cut off - risk of loss of control of the vehicle!

! Never leave your vehicle with the electronic key still inside.

Switching on the ignition without starting the engine



With the electronic key in the passenger compartment, pressing the **"START/STOP"** button, **without depressing any of the pedals**, allows the ignition to be switched on without starting the engine.

- ▶ Press this button again to switch off the ignition and allow the vehicle to be locked.

Key not detected

Back-up starting

A back-up reader is fitted to the steering column, to enable the engine to be started if the system fails to detect the key in the recognition zone, or if the battery in the electronic key is flat.

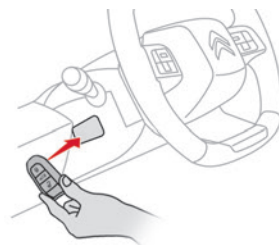

- ▶ Place and hold the remote control against the reader.
- ▶ **With a manual gearbox**, place the gear lever in neutral, then fully depress the clutch pedal.
- ▶ **With an automatic gearbox or a drive selector**, select mode **P**, then depress the brake pedal.
- ▶ Press the **"START/STOP"** button. The engine starts.

Back-up switch-off



If the electronic key is not detected or is no longer in the recognition zone, a message

appears in the instrument panel when closing a door or trying to switch off the engine.

► To confirm the instruction to switch off the engine, press the "**START/STOP**" button for approximately 5 seconds.

In the event of a fault with the electronic key, contact a CITROËN dealer or a qualified workshop.

Emergency switch-off

In case of emergency only, the engine can be switched off without conditions (even when driving).

► Press the "**START/STOP**" button for about 5 seconds.

In this case, the steering column locks as soon as the vehicle stops.

Starting/Switching off the electric motor

Starting

The drive selector must be in mode **P**.

► If using a remote control key, depress the brake pedal and turn the key until it reaches position **3** (Start).

► If using Keyless Entry and Start, depress the brake pedal and briefly press the "**START/STOP**" button.

► Keep your foot on the brake pedal until the **READY** indicator lamp comes on and an audible

signal is emitted, indicating that the vehicle is ready to drive.

► With your foot on the brake, select mode **D** or **R**.

► Release the brake pedal, then accelerate.

On starting, the instrument panel lights up and the power indicator cursor moves to the "neutral" position. The steering column automatically unlocks (you may hear a sound and feel the steering wheel move).

Switching off

► If using a remote control key, turn the key fully to position **1** (Stop).

► If using Keyless Entry and Start, press the "**START/STOP**" button.

Before exiting the vehicle, check that:

- The drive selector is in mode **P**.
- The **READY** indicator lamp is off.

i The drive selector moves automatically to mode **P** when the motor is switched off or when the driver's door is opened.

i If the driver's door is opened while the required conditions for switching off are not met, an audible signal is emitted, accompanied by the display of a warning message.

i For the procedures for switching on the ignition without starting the engine and those for back-up starting/switching off using

the Keyless Entry and Start system, refer to the **Starting/Switching off the engine using Keyless Entry and Start section**.

Manual parking brake

Release



► Pull the parking brake lever up slightly, press the release button, then lower the lever fully.

(!) / **(P)** When driving the vehicle, if this warning lamp and the **STOP** warning lamp come on, accompanied by an audible signal and the display of a message, this means that the parking brake is still applied or has not been fully released.

Application

► Pull the parking brake lever up to immobilise the vehicle.

! When parking on a slope, turn the wheels against the kerb, apply the parking brake, engage a gear and switch off the ignition.

Electric parking brake

In automatic mode, this system applies the parking brake when the engine is switched off and releases it when the vehicle moves off.

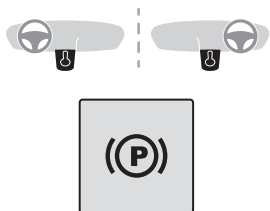

At any time, with the engine running:

► To apply the parking brake, briefly pull the control.

► To release it, briefly push the control while pressing the brake pedal.

Automatic mode is activated by default.

This automatic operation can be temporarily deactivated.

Indicator lamp

 This indicator lamp comes on both on the instrument panel and on the control to confirm that the parking brake has been applied, accompanied by display of the message **"Parking brake applied"**.

The indicator lamp goes out to confirm the release of the parking brake, accompanied by the display of the message **"Parking brake released"**.

The indicator lamp flashes in response to a manual request to apply or release the brake.

 In the event of a battery failure, the electric parking brake will not operate. As a safety measure, with a manual gearbox, if the parking brake is not applied, immobilise the vehicle by engaging a gear.

As a safety measure, with an automatic gearbox or drive selector, if the parking brake is not applied, immobilise the vehicle by placing the supplied chock against one of the wheels.

Contact a CITROËN dealer or a qualified workshop.

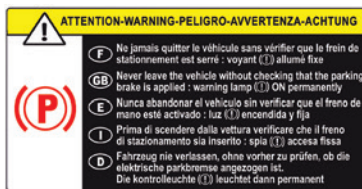

 Before leaving the vehicle, check that the parking brake is applied: the parking brake indicator lamps on the instrument panel and the control must be on fixed.

If the parking brake is not applied, there is an audible signal and a message is displayed on opening the driver's door.

 Never leave a child alone inside the vehicle, as they could release the parking brake.

 **When the vehicle is parked: on a steep slope, heavily loaded or during towing**

With a manual gearbox, turn the wheels toward the pavement and engage a gear. With an automatic gearbox or a drive selector, turn the wheels toward the pavement and select mode **P**.

When towing, the vehicle is approved for parking on slopes of up to 12%.

Manual operation

Manual release

With the ignition on or engine running:

- Press the brake pedal.
- While maintaining pressure on the brake pedal, briefly push the control.

 If the brake pedal is not depressed, the parking brake is not released and a message is displayed.

Manual application

With the vehicle stationary:

- Briefly pull the control.

The control indicator lamp flashes to confirm the application request.

Automatic operation

Automatic release

First ensure that the engine is running and that the driver's door is closed.

The electric parking brake gradually releases automatically as the vehicle moves off.

With a manual gearbox

- ▶ Fully depress the clutch pedal and engage first gear or reverse.
- ▶ Depress the accelerator pedal and release the clutch pedal.

With an automatic gearbox

- ▶ Depress the brake pedal.
- ▶ Select mode **D**, **M** or **R**.
- ▶ Release the brake pedal and depress the accelerator pedal.

With a drive selector

- ▶ Depress the brake pedal.
- ▶ Select mode **D**, **B** or **R**.
- ▶ Release the brake pedal and depress the accelerator pedal.

i With an automatic gearbox or drive selector, if the brake does not release automatically, check that the front doors are properly closed.

! When stationary with the engine running, do not depress the accelerator pedal unnecessarily. Risk of parking brake release.

Automatic application

With the vehicle stationary, the parking brake is applied automatically when the engine is switched off.

! It is not applied automatically if the engine stalls or enters STOP mode with Stop & Start.

i In automatic mode, the parking brake can be manually applied or released at any time using the control.

Special cases

Immobilising the vehicle with the engine running

To immobilise the vehicle with the engine running, briefly pull the control.

Parking the vehicle with the brake released

! In very cold conditions (ice), applying the parking brake is not recommended.

To immobilise the vehicle, engage a gear or place the chocks against one of the wheels.

i With an automatic gearbox or drive selector, mode **P** is automatically

selected when the ignition is switched off. The wheels are blocked.

For more information on **Free-wheeling**, refer to the corresponding section.

i With an automatic gearbox or drive selector, while mode **N** is selected, opening the driver's door triggers an audible signal. It stops when the driver's door closes again.

Deactivating automatic operation

In some situations, for example when it is extremely cold or when towing (e.g. caravan, breakdown), it may be necessary to deactivate automatic operation of the system.

- ▶ Start the engine.
- ▶ Use the control to apply the parking brake, if it is released.
- ▶ Take your foot fully off the brake pedal.
- ▶ Keep the control pushed in the release direction for 10 to a maximum of 15 seconds.
- ▶ Release the control.
- ▶ Depress and hold the brake pedal.
- ▶ Pull the control in the application direction for 2 seconds.



This indicator lamp on the instrument panel comes on to confirm deactivation of the automatic functions.

- ▶ Release the control and the brake pedal.

From this point onwards, only the manual functions, using the control, allow the parking brake to be applied and released.

► Follow this procedure again to reactivate automatic operation (confirmed by the indicator lamp on the instrument panel going out).

Emergency braking

If depressing the brake pedal fails to provide effective braking or in exceptional circumstances (e.g. driver unwell, assisted driving), the vehicle can be braked by sustained pulling on the electric parking brake control. Braking continues for as long as the control is kept pulled, and ceases when the control is released.

The ABS and DSC systems stabilise the vehicle during emergency braking.

If emergency braking malfunctions, the message "**Parking brake fault**" will be displayed on the instrument panel.



If the ABS and DSC systems malfunction, indicated by lighting one or both warning lamps on the instrument panel, the vehicle's stability is no longer ensured.

► In this case, ensure the vehicle's stability by successive and repeated "pull-release" actions on the electric parking brake control until the vehicle comes to a complete stop.

6-speed manual gearbox

Engaging 5th or 6th gear

► Move the gear selector fully to the right to engage 5th or 6th gear.

! Failure to follow this instruction could cause permanent damage to the gearbox (inadvertent engagement of 3rd or 4th gear).

Engaging reverse gear



► Raise the ring under the knob and move the gear selector to the left, then forwards.

! Only engage reverse gear when the vehicle is stationary with the engine at idle.

i As a safety precaution and to facilitate starting the engine:

- Always select neutral.
- Press the clutch pedal.

Automatic gearbox

Automatic 8-speed gearbox with push selector. It also offers a manual mode with gear changes via control paddles located behind the steering wheel.

Push selector

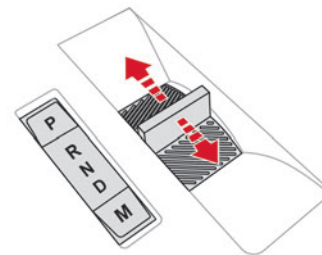

P. Auto Park

Press this button to switch to Parking mode. For parking the vehicle: the front wheels are blocked.

R. Reverse

N. Neutral

To free-wheel and move the vehicle, with the ignition off.

For more information on **Free-wheeling**, refer to the corresponding section.

D. Driving in automatic mode

The gearbox manages gear changes according to the style of driving, the road profile and the vehicle load.

M. Driving in manual mode

Press this button to switch to manual mode.
The driver changes gear using the steering-mounted controls.

- ▶ In mode **N**, with your foot on the brake pedal, push without passing the point of resistance:
 - Forwards, mode **R** is selected.
 - Backwards, mode **D** is selected.

Release the selector fully after each push; it will then return to its initial position.

Special cases

To avoid mode **N** (quick change from **D** to **R** and back again):

- ▶ In mode **R**, push backwards past the point of resistance, mode **D** is selected.
- ▶ In mode **D**, push forwards past the point of resistance, mode **R** is selected.
- ▶ To return to mode **N**, push without passing the point of resistance.

Steering-mounted controls

(Depending on equipment)

In mode **M** or **D**, the steering-mounted control paddles can be used to change gear manually. They cannot be used to select neutral or to engage or disengage reverse gear.



- ▶ Pull the "+" or "-" paddle towards you and release to shift up or down a gear, respectively.

Information displayed on the instrument panel

When the ignition is switched on, the gearbox status is displayed on the instrument panel:

P	Parking
R	Reverse
N	Neutral
D1...8	Automatic forward gear
M1...8	Manual forward gear

The state of the gearbox remains displayed on the instrument panel for a few seconds after switching off the ignition.

Operation

Only appropriate mode change instructions are validated.

With the engine running, if it is necessary to depress the brake pedal to change modes, an alert message will be displayed on the instrument panel.

! With the engine running and the brakes released, if **R**, **D** or **M** is selected, the vehicle moves off, even without pressing the accelerator pedal.

Never depress the accelerator and brake pedals at the same time - risk of damage to the gearbox!

i If you open the driver's door while mode **N** is engaged, an audible signal will sound. The audible signal stops when the driver's door is closed.

! At very low speeds, opening the driver's door triggers the gearbox to switch to mode **P**.

! In the event of battery failure, it is essential to place the chock(s) supplied with the tool kit against one of the wheels to immobilise the vehicle.

Special aspects of automatic mode

The gearbox selects the gear that provides optimal performance based on ambient temperature, road profile, vehicle loading and driving style.

For maximum acceleration, press the accelerator fully down (kick-down). The gearbox changes down automatically or holds the selected gear until the maximum engine speed is reached.

Steering mounted controls allow the driver to temporarily select a gear, if the vehicle speed and engine speed conditions permit.

Special aspects of manual mode

The gearbox only changes from one gear to another if the vehicle speed and engine speed conditions permit.

Starting the vehicle

- ▶ Fully depress the brake pedal.
 - ▶ Start the engine.
 - ▶ With your foot on the brake pedal, push once or twice backwards to select automatic mode **D**, or forwards to shift into reverse gear **R**.
 - ▶ Release the brake pedal.
 - ▶ Accelerate gradually to automatically release the electric parking brake.
- The vehicle moves off immediately.



Automatic gearbox

Never try to start the engine by pushing the vehicle.

Switching the vehicle off

Regardless of the current gearbox mode, mode **P** is immediately engaged automatically when the ignition is switched off.

However, in mode **N**, mode **P** will be engaged after a delay of 5 seconds (time to enable free-wheeling mode).

Check that mode **P** has been engaged and that the electric parking brake was applied automatically; if not, apply it manually.



The corresponding indicator lamps on the gear selector and the electric parking brake control must be on, as well as the indicator lamps on the instrument panel.

Gearbox malfunction



This warning lamp comes on, accompanied by an audible signal and the display of a message.

Visit a CITROËN dealer or a qualified workshop. Do not drive faster than 62 mph (100 km/h), keeping to the speed limit.

Switching of the gearbox to back-up mode

Mode **D** locks in third gear. The paddles on the steering wheel do not work and mode **M** is no longer accessible. You may feel a significant jolt on engaging reverse gear. This will not damage the gearbox.

Selector malfunction

Minor malfunction



This warning lamp comes on, accompanied by the display of a message and an audible signal.

Drive carefully.

Visit a CITROËN dealer or a qualified workshop. In some cases, the selector indicator lamps may no longer come on, but the gearbox state is still displayed on the instrument panel.

Major malfunction



This warning lamp comes on, accompanied by the display of a message.



You must stop the vehicle.

Stop as soon as it is safe to do so and switch off the ignition. Contact a CITROËN dealer or a qualified workshop.

Drive selector (Electric)

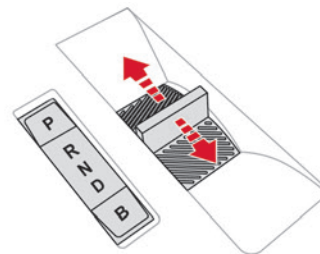

The drive selector is a pulse selector with a regenerative braking function.

The drive selector provides traction control based on the driving style, the road profile and the vehicle load.

With regenerative braking activated, it also manages engine braking when the accelerator pedal is released.

P. Park

Button for parking the vehicle: the front wheels are locked (the button lights up to indicate that it is activated).

R. Reverse

To engage reverse gear, with your foot on the brake pedal.

N. Neutral

To move the vehicle with the ignition off and so allow it to free-wheel.

For more information on **Free-wheeling**, refer to the corresponding section.

D. Drive (automatic forward gear)**B.** Brake (regenerative braking)

Button for changing to Drive/automatic forward gear mode with regenerative braking function (the button lights up to indicate that it is activated).

Information displayed on the instrument panel

When the ignition is switched on, the drive selector status is displayed on the instrument panel:

P : Park.

R : Reverse.

N : Neutral.

D : Drive (automatic forward gear).

B : Brake (automatic forward gear with regenerative braking function activated).

Operation

► In mode **N**, with your foot on the brake pedal, push without passing the point of resistance:

- Forwards, mode **R** is selected.
- Backwards, mode **D** is selected.

Release the selector fully after each push; it will then return to its initial position.

Special cases

To avoid mode **N** (quick change from **D** to **R** and back again):

► In mode **R**, push backwards past the point of resistance, mode **D** is selected.

► In mode **D**, push forwards past the point of resistance, mode **R** is selected.

► To return to mode **N**, push without passing the point of resistance.

Regenerative braking

With the Brake function and when decelerating

The Brake function emulates engine braking, slowing the vehicle with no need to depress the brake pedal. The vehicle slows more quickly when the driver releases the accelerator pedal. The energy recovered when the accelerator pedal is released is then used to partially recharge the traction battery, thereby increasing the vehicle's driving range.

! The resulting deceleration of the vehicle does not cause the brake lamps to come on.

► From mode **D**, press button **B** to activate/deactivate the function (the button lights up when the function is activated).

B is displayed on the instrument panel.

The system status is not saved when the ignition is switched off.

! In some situations (e.g. battery full, extreme temperatures), the amount of regenerative braking may be temporarily limited, resulting in less deceleration. The driver must remain alert to traffic conditions and must always be ready to use the brake pedal.

With the brake pedal

When the brake pedal is depressed, the intelligent braking system automatically recovers some of the energy and uses it to recharge the traction battery.

This energy recovery also reduces use of the brake pads, thereby limiting their wear.

i The driver may experience a different sensation when depressing the brake pedal compared to a vehicle without regenerative braking.

Driving modes

The driving modes available depend on the engine and equipment of the vehicle.

Driving modes are selected using the following control:

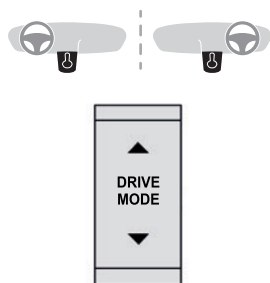

► Press the control to display the modes on the instrument panel.

When the message disappears, the selected mode is activated and remains indicated on the instrument panel (except **Normal mode**).

Whenever the ignition is switched on, **Normal** driving mode is selected by default.

Normal

To restore the default settings.

Eco

To reduce energy consumption by reducing the performance of the heating and air conditioning, without deactivating them.

Free-wheeling in **Eco** mode: depending on version, with the EAT8 gearbox, switching into "free-wheeling" is encouraged to slow the vehicle down without using engine braking. You can save fuel by taking your foot gradually and

fully off the accelerator pedal in anticipation of slowing down.

To reduce consumption of the traction battery's electrical energy by limiting engine torque.

Sport

To obtain more dynamic driving with action on the accelerator and gear changes with an automatic gearbox.

Hill start assist

This system keeps the vehicle briefly stationary (for approximately 2 seconds) when making a hill start, while you transfer your foot from the brake pedal to the accelerator pedal.

The system is only active when:

- The vehicle is completely stationary, with your foot on the brake pedal.
- Certain slope conditions are met.
- The driver's door is closed.

! Do not leave the vehicle while it is being held temporarily by hill start assist.

If someone needs to get out of the vehicle with the engine running, apply the parking brake manually. Then check that the parking brake indicator lamp and the **P** indicator lamp in the electric parking brake control are on fixed.

! The hill start assist function cannot be deactivated. However, using the parking

brake to immobilise the vehicle interrupts its operation.

Operation

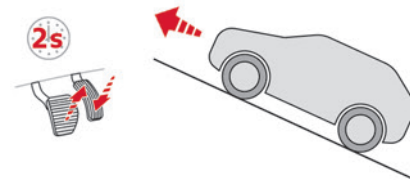

Facing uphill, with the vehicle stationary, the vehicle is held for a short time when the driver releases the brake pedal:

- If first gear or neutral is engaged on a manual gearbox.
- If mode **D** or **M** is selected on an automatic gearbox.
- If mode **D** or **B** is selected on the drive selector.

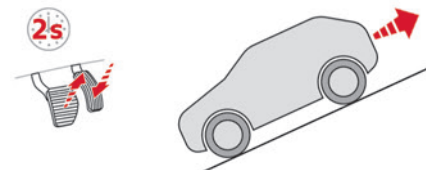

Facing downhill, with the vehicle stationary and reverse gear engaged, the vehicle is held for a short time when the driver releases the brake pedal.

Malfunction



If the event of a malfunction, these warning lamps light up on the instrument panel, accompanied by the display of a message.

Have it checked by a CITROËN dealer or a qualified workshop.

Gear shift indicator

(Depending on engine)

This system is designed to reduce fuel consumption by recommending the most suitable gear.

Operation

Depending on the driving situation and the vehicle's equipment, the system may recommend skipping one or more gears. Gear engagement recommendations are not to be considered mandatory. Indeed, the configuration of the road, the traffic density and safety remain determining factors when choosing the best gear. Therefore, the driver remains responsible for deciding whether or not to follow the system's advice.

The system cannot be deactivated.

- With an automatic gearbox, the system is only active in manual operation.



The information appears on the instrument panel, in the form of an arrow and the recommended gear.

- The system adapts the gear change instructions according to the driving conditions (e.g. slope, load) and driving style (e.g. power demand, acceleration, braking). The system never suggests:
 - engaging first gear;
 - engaging reverse gear.

Stop & Start

The Stop & Start function puts the engine temporarily into standby - STOP mode - during phases when the vehicle is stationary (e.g. red lights, traffic jams). The engine automatically restarts - START mode - as soon as the driver indicates the intention of moving off again.

Primarily designed for urban use, the function is intended to reduce fuel consumption and exhaust emissions as well as the noise level when stationary.

The function does not affect the functionalities of the vehicle, in particular the braking.

Deactivation/Reactivation

The function is **activated** by default when the ignition is switched on.



The settings are changed via the **Driving/Vehicle** touch screen menu.

A message on the instrument panel confirms the change of status.

When the function is deactivated, if the engine was in standby, it restarts immediately.

Associated indicator lamps



Function activated.



Function deactivated or malfunction.



Opening the bonnet

Before doing anything under the bonnet, deactivate the Stop & Start system to avoid any risk of injury caused by the engine restarting automatically.



Driving on flooded roads

Before entering into a flooded area, it is strongly recommended that you deactivate the Stop & Start system.

For more information on **Driving recommendations**, particularly on flooded roads, refer to the corresponding section.

Operation

Main conditions for operation

- The driver's door must be closed.
- The driver's seat belt must be fastened.

- The level of charge in the battery must be sufficient.
- The temperature of the engine must be within its nominal operating range.
- The outside temperature must be between 0°C and 35°C.

Putting the engine into standby (STOP mode)

The engine automatically enters standby mode as soon as the driver indicates their intention to stop:

- **With a manual gearbox:** with the gear lever in neutral and the clutch pedal released.
- **With an automatic gearbox:** with the gear selector in mode **D** or **M**, the brake pedal depressed until the vehicle stops or the gear selector in mode **N**, with the vehicle stationary.

Time counter

A time counter adds up the time spent in standby during the journey. It is reset to zero every time the ignition is switched on.

Special cases:

The engine will not go into standby if the conditions for operation are not met and in the following cases:

- Steep slope (ascending or descending).
- Vehicle has not exceeded 6 mph (10 km/h) since the last engine start (with the key or the **START/STOP** button).

- Needed to maintain a comfortable temperature in the passenger compartment.
- Demisting active.



In these cases, this indicator lamp flashes for a few seconds, then goes off.

I After the engine has restarted, STOP mode is not available until the vehicle has reached a speed of 5 mph (8 km/h).

I During parking manoeuvres, STOP mode is not available for a few seconds after coming out of reverse gear or turning the steering wheel.

Restarting the engine (START mode)

The engine automatically restarts as soon as the driver indicates the intention of moving off again:

With a manual gearbox: with the clutch pedal fully depressed.

With an automatic gearbox:

- With the selector in mode **D** or **M**: with the brake pedal released.
- With the selector in mode **N** and the brake pedal released: with the selector at **D** or **M**.
- With the selector in mode **P** and the brake pedal depressed: with the selector at **R**, **N**, **D** or **M**.
- With reverse gear engaged.

Special cases

The engine will restart automatically if the conditions for operation are met again and in the following cases:

- With a manual gearbox: vehicle speed exceeds 2.5 mph (4 km/h).
- With an automatic gearbox, in mode **N**, vehicle speed exceeds 0.6 mph (1 km/h).



In these cases, this indicator lamp flashes for a few seconds, then goes off.

Malfunctions



In the event of a fault with the system, this warning lamp flashes for a few moments on the instrument panel, then remains on, accompanied by the display of a message. Have it checked by a CITROËN dealer or a qualified workshop.

The vehicle stalls in STOP mode

All of the instrument panel warning lamps come on if there is a fault.

- Switch off the ignition then start the engine again with the key or the **"START/STOP"** button.



12 V battery

The Stop & Start system requires a 12 V battery of specific technology and specification.

All work must be carried out only by a CITROËN dealer or a qualified workshop

Tyre under-inflation detection

This system alerts the driver if one or more tyres suffer a drop in pressure.

The alert is raised when the vehicle is moving, not when stationary.

It compares the information given by the wheel speed sensors with **reference values, which must be reinitialised every time the tyre pressures are adjusted or a wheel changed**. It takes into account the last values stored during the reinitialisation request. It is therefore essential that the tyre pressure is correct during the operation. This operation is the driver's responsibility.

! The tyre under-inflation detection cannot, in any circumstances, replace the need for vigilance on the part of the driver.

This system does not avoid the need to regularly check the tyre pressures (including the spare wheel), especially before a long journey.

Driving with under-inflated tyres, particularly in adverse conditions (heavy load, high speed, long journey):

- worsens road-holding.
- lengthens braking distances.
- causes premature wear of the tyres.
- increases energy consumption.

i The inflation pressures defined for the vehicle can be found on the tyre pressure label.

For more information on the **Identification markings**, refer to the corresponding section.

! Checking tyre pressures

This check should be done monthly when the tyres are "cold" (vehicle stopped for 1 hour or after a journey of less than 6 miles (10 km) at moderate speeds). Otherwise, add 0.3 bar to the pressures shown on the label.

i Snow chains

The system does not have to be reinitialised after fitting or removing snow chains.

Under-inflation alert



This is signalled by the fixed illumination of this warning lamp, accompanied by an audible signal and, depending on equipment, the display of a message.

- ▶ Reduce speed immediately, avoid excessive steering movements and avoid sudden braking.
- ▶ Stop the vehicle as soon as it is safe to do so.

! The loss of pressure detected may not always cause visible deformation of the tyre.

Do not rely on just a visual check.

- ▶ Using a compressor, such as the one in the temporary puncture repair kit, check the pressures of all four tyres when cold.
- ▶ If it is not possible to carry out this check immediately, drive carefully at reduced speed.
- ▶ In the event of a puncture, use the temporary puncture repair kit or the spare wheel (depending on equipment).

! Driving too slowly may not ensure optimum monitoring.

The alert is not immediately triggered in the event of a sudden loss of pressure or tyre blow-out. This is because analysis of the values read by the wheel's speed sensors can take several minutes.

The alert may be delayed at speeds below 25 mph (40 km/h), or when adopting a sporty driving mode.

i The alert is kept active until the system is reinitialised.

Reinitialisation

- ▶ The system must be reinitialised after any adjustment to the pressure of one or more tyres, and after changing one or more wheels.

! Before reinitialising the system, make sure that the pressures of the four tyres are correct for the conditions of use of the vehicle and conform to the values written on the tyre pressure label.

Check the pressures of the four tyres before performing the reinitialisation.

The system does not advise if a pressure is incorrect at the time of reinitialisation.



With the vehicle stationary, the system is reinitialised via the **Driving/Vehicle** touch screen menu.

Malfunction



In the event of a malfunction, these warning lamps light up on the instrument panel.

A message appears, accompanied by an audible signal.

In this case, the tyre under-inflation monitoring function is no longer performed.

Have it checked by a CITROËN dealer or a qualified workshop.

i Non-standard or 'space-saver' spare wheel

The use of this type of spare wheel may suspend tyre pressure monitoring.

In this case, the malfunction warning lamp comes on and disappears once the wheel has been replaced by one of uniform size (the same as the others), the pressure readjusted and the reinitialisation carried out.

ConnectedCAM Citroën

(Depending on country of sale)

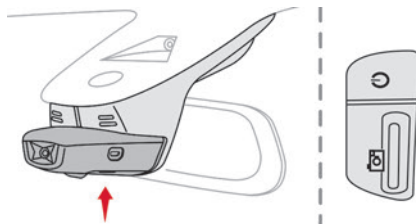

This camera, installed at the top of the windscreen and connected wirelessly, allows you to:

- Take photos and videos on demand and share them.
- Send the vehicle's GPS coordinates to a smartphone.
- Record videos automatically in the event of a vehicle impact.

i As the use of the ConnectedCAM Citroën® is under your control and your responsibility, you must comply with the regulations for the protection of personal data (e.g. images of other people, vehicle number plates, protected buildings, etc.). Check first that your insurance company accepts the footage collected from the ConnectedCAM Citroën® as evidence.

! Without exception, any action which the driver takes concerning the camera must be **with the vehicle stationary**.

Operation

To use all camera functions, you must perform the following operations:

- ▶ Download the **ConnectedCAM Citroën** application onto a smartphone.
- ▶ Pair the smartphone with the camera following the instructions given by the application.

Pairing is necessary at the first connection. After this it will be automatic.

The default pairing code is: "ConnectedCAM".

On/Off



- ▶ Press and hold this button to switch the camera on/off (confirmed by the indicator lamp coming on/going off).

When the camera is switched on, video recording is automatic and permanent.

The status of the function is stored when the ignition is switched off.

Managing photos and videos



- ▶ Press this button briefly to take a photo.

An audible signal confirms that the request has been acknowledged.

- ▶ Press and hold this button to record a video.

A micro USB socket also allows the data from the camera to be saved onto other media such as computers, tablets, etc.

Thanks to the **ConnectedCAM Citroën** application, you can then automatically and immediately share your photos and videos on social networks or by email.

An audible signal confirms that the request has been acknowledged.

Resetting the system



► Press and hold these 2 buttons simultaneously to reset the system.

This action erases all data recorded in the camera and reinitialises the camera's default pairing code.

! For safety reasons, the driver must not use the ConnectedCAM Citroën application from a smartphone while driving. He or she must perform any action requiring sustained attention when the vehicle is stationary.

Malfunction



When a system fault occurs, the indicator lamp in the button flashes.

Have the system checked by a CITROËN dealer or a qualified workshop.

Driving and manoeuvring aids - General recommendations

i Driving and manoeuvring aids cannot, in any circumstances, replace the need for vigilance on the part of the driver.

The driver must comply with the Highway Code, must remain in control of the vehicle in all circumstances and must be able to retake control of it at all times. The driver must adapt the speed to climatic conditions, traffic and the state of the road.

It is the driver's responsibility to constantly monitor traffic conditions, assess the distance and relative speed of other vehicles, and anticipate their manoeuvres before using the direction indicator and changing lanes.

These systems do not make it possible to exceed the laws of physics.

i Driving aids

You should hold the steering wheel with both hands, always use the door and interior mirrors, always leave your feet close to the pedals and take a break every 2 hours.

i Manoeuvring aids

The driver must always check the surroundings of the vehicle before and during

the whole manoeuvre, in particular using the mirrors.

! Radar(s)

The operation of the radar(s), along with any associated functions, may be affected by the accumulation of dirt (e.g. mud, ice), in poor weather conditions (e.g. heavy rain, snow), or if the bumpers are damaged. If the front bumper is to be repainted, contact a CITROËN dealer or a qualified workshop; certain types of paint could interfere with the operation of the radar(s).

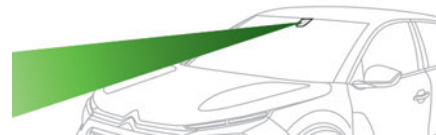

! Driving aids camera

This camera and its associated functions may be impaired or not work if the windscreen area in front of the camera is dirty, misty, frosty, covered with snow, damaged or masked by a sticker.

In humid and cold weather, demist the windscreen regularly.

Poor visibility (inadequate street lighting, heavy rain, thick fog, snowfall), dazzle (headlamps of an oncoming vehicle, low sun, reflections on a damp road, leaving a tunnel,

alternating shade and light) can also impair detection performance.

In the event of a windscreen replacement, contact a CITROËN dealer or a qualified workshop to recalibrate the camera; otherwise, the operation of the associated driving aids may be disrupted.

i Other cameras

The images from the camera(s) displayed on the touch screen or on the instrument panel may be distorted by the terrain.

In the presence of areas in shade, or in conditions of bright sunlight or inadequate lighting, the image may be darkened and with lower contrast. Obstacles may appear further away than they actually are.

! Sensors

The operation of the sensors, as well as any associated functions, may be disrupted by noise pollution such as that emitted by noisy vehicles and machinery (e.g. lorries, pneumatic drills), by the accumulation of snow or dead leaves on the road or in the event of damaged bumpers and mirrors. When reverse gear is engaged, an audible signal (long beep) indicates that the sensors may be dirty.

A front or rear impact to the vehicle can upset the sensors' settings, which is not always detected by the system: distance measurements may be distorted. The sensors do not systematically detect obstacles that are too low (pavements, studs) or too thin (trees, posts, wire fences). Certain obstacles located in the sensors' blind spots may not be detected or may no longer be detected during the manoeuvre. Certain materials (fabrics) absorb sound waves: pedestrians may not be detected.

i Maintenance

Clean the bumpers and door mirrors and the field of vision of the cameras regularly. When washing your vehicle at high pressure, direct the spray from at least 30 cm away from the radar, sensors and cameras.

! Mats/Pedal trims

The use of mats or pedal trims not approved by CITROËN may interfere with the operation of the speed limiter or cruise control.

To avoid any risk of jamming the pedals:

- Ensure that the mat is secured correctly.
- Never fit one mat on top of another.

i Units of speed

Ensure that the units of speed displayed on the instrument panel (mph or km/h) are those for the country you are driving in. If this is not the case, when the vehicle is stationary, set the display to the required units of speed so that it complies with what is authorised locally.

In case of doubt, contact a CITROËN dealer or a qualified workshop.

Road signs recognition

! For more information, refer to the **General recommendations on the use of driving and manoeuvring aids.**

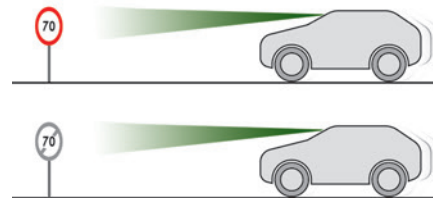



This system displays the maximum speed authorised locally on the instrument panel, using:



- Speed limit signs detected by the camera.
- Speed limit information from the navigation system's mapping.

- Signs indicating a shared traffic zone detected by the camera.

Sign detected	Suggested speed (calculated)
Entry into a shared traffic zone Example: 	Without CITROËN Connect Nav 10 mph or 20 km/h (depending on the units on the instrument panel) With CITROËN Connect Nav Display of the speed in force in the country you are driving in.

- Some supplementary traffic signs detected by the camera.

Supplementary traffic sign detected	Display of the speed associated with the supplementary traffic sign
Speed limit when raining Examples: 	If the wiper control stalk is in the "intermittent wipe" or "automatic wipe" position (in order to activate the rain sensor): 68 mph (110 km/h) (for example)
Speed limit when towing 	If an approved towing device is fixed to the vehicle: 56 mph (90 km/h) (for example)
Speed limit applicable over a certain distance Example: 	43 mph (70 km/h) (for example)

Supplementary traffic sign detected	Display of the speed associated with the supplementary traffic sign
Speed limit for vehicles with a gross vehicle weight or gross train weight less than 3.5 tonnes 	56 mph (90 km/h) (for example)
Speed limit in case of snow Example: 	If the outside temperature is below 3°C: 19 mph (30 km/h) (for example) with a "snowflake" symbol
Speed limit at certain times of the day Example: 	19 mph (30 km/h) (for example) with a "clock" symbol

! Navigation mapping should be regularly updated in order to receive accurate speed limit information from the system.

! The units for the speed limit (mph or km/h) depend on the country you are driving in. This should be taken into account to ensure you observe the speed limit. For the system to work properly when changing countries, the speed unit of the instrument panel must match that of the country you are driving in.

! Automatic sign reading is a driving aid system and does not always display the correct speed limits. The speed limit signs present on the road always take priority over those displayed by the system. The system is designed to detect signs that conform to the Vienna Convention on road signs.

i Specific speed limits, such as those for heavy goods vehicles, are not displayed. The display of the speed limit on the instrument panel is updated when passing a speed limit sign intended for cars (light vehicles).

Activation/Deactivation

By default, the system is automatically activated at every engine start.



The settings are changed via the **Driving/Vehicle** touch screen menu.

Information displayed on the instrument panel



1. Detected speed limit indication or
2. End of speed limit indication



The system is active but is not detecting speed limit information.



On detecting speed limit information, the system displays the value.



For a suggested maximum speed, the first time that the vehicle exceeds it **by more than 3 mph (5 km/h)** (e.g. 59 mph (95 km/h)), the speed is displayed and flashes for 10 seconds (depending on version).

Operating limits

The system does not take account of reduced speed limits, especially those imposed in the following cases:

- Atmospheric pollution.
- Towing.
- Driving with a space-saver type spare wheel or snow chains fitted.
- Tyre repaired using the temporary puncture repair kit.
- Young drivers.

The system may not display the speed limit if it does not detect a speed limit sign within a preset period and in the following situations:

- Road signs that are obstructed, non-standard, damaged or bent.
- Obsolete or incorrect maps.

Speed setting recommendations

The driver can select the speed displayed by the **Road signs recognition** system as the speed setting for the speed limiter, cruise control or adaptive cruise control using the **OK** button. In the event of rain detection, the system offers the driver a speed setting lower than the speed read/from the map in order to adapt to weather conditions (e.g. on motorways, the proposed speed is 68 mph (110 km/h) instead of 81 mph (130 km/h)).



This additional system recognises these road signs and displays them on the instrument panel if the appropriate display mode is selected:

- **No entry:** when entering a lane in the wrong direction, an alert message, including the symbol of this sign, is displayed on the instrument panel (request to check the direction of traffic).
- **Other signs:** as you approach it, the symbol of the corresponding sign is displayed on the instrument panel.

! The actual road signs always take priority over the display from the system. The signs must comply with the Vienna Convention on road signs.

Activation / Deactivation

 It is set via the **Driving / Vehicle** touch screen menu.

Speed limiter

! For more information, refer to the **General recommendations on the use of driving and manoeuvring aids.**

 This system prevents the vehicle from exceeding the speed programmed by the driver (speed setting).

i For more information on the **Speed limiter**, **Cruise control** or **Adaptive cruise control**, refer to the corresponding sections.

Steering-mounted controls



1. Select speed limiter mode
2. Select cruise control mode
3. Memorise the speed setting

Information displayed on the instrument panel



4. Current speed setting
5. Speed memorisation prompt
6. Current speed limit indication

Memorising the speed setting

► Switch on the speed limiter **1-LIMIT** or cruise control **2**.

Information related to the speed limiter or cruise control is displayed.

When a new speed setting is detected, the system displays the value and **"OK?"** flashes for a few seconds to suggest saving it as a new speed setting.

i If there is a difference of less than 3 mph (5 km/h) between the speed setting and the speed displayed by the Road signs recognition, the **"OK?"** symbol is not displayed.

Depending on the road conditions, several speeds may be displayed.

► Press **3-OK** to confirm the new speed setting. The display then reverts to its previous state.

Extended Traffic Sign Recognition

! For more information, refer to the **General recommendations on the use of driving and manoeuvring aids.**

The speed limiter is switched on manually. The minimum speed setting is 19 mph (30 km/h). The speed setting remains in the system memory when the ignition is switched off.

Steering-mounted controls



1. Speed limiter selection
2. Switch on/pause the speed limiter at the previously saved speed setting
3. Increase/Decrease the speed setting
4. Activate the speed limiter at the previously saved speed setting
Use the speed suggested by the Road signs recognition function

For more information on the **Road signs recognition** function, refer to the corresponding section.

Information displayed on the instrument panel

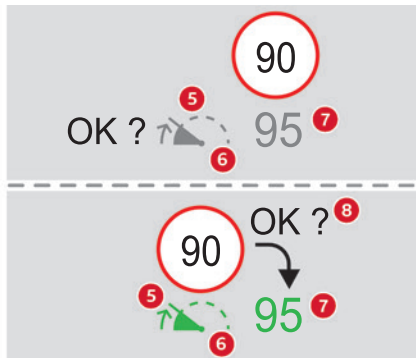

5. Speed limiter mode selection indication
6. Speed limiter on (green)/pause (grey) indication
7. Speed setting value
8. Speed suggested by the Road signs recognition function (depending on version)

Switching on/Pausing

- ▶ Press **1-LIMIT** to select the speed limiter mode; the function is paused (grey).
- ▶ If the limit speed setting is suitable (most recent speed setting programmed in the system), press **2-|>** or **4-OK** to switch the speed limiter on (green).
- ▶ Pressing **2-|>** again temporarily pauses the function.

i When the speed setting remains below the vehicle's speed for a prolonged period of time, an audible warning is emitted.

Adjusting the speed setting

You do not have to switch the speed limiter on in order to set the speed.

To change the speed setting using the vehicle's current speed:

- ▶ For steps of +/- 1 mph (1 km/h), make successive short presses upwards/downwards on **3** to increase/decrease.
- ▶ For steps of +/- 5 mph (5 km/h), press and hold upwards/downwards on **3** to increase/decrease.

To modify the cruise speed setting based on the speed suggested by the Road signs recognition, as shown on the instrument panel:

– **When passing the sign:**

- ▶ Press **4-OK** to save the suggested speed. This value is then immediately shown as the new speed setting on the instrument panel.

– **After passing the sign:**

- ▶ Press **4-OK**. The message "OK?" is displayed to confirm the request to save.
- ▶ Press **4-OK** again to save the suggested speed. The new speed setting value is displayed on the instrument panel.

Temporarily exceeding the speed setting

- ▶ Fully depress the accelerator pedal.

The speed limiter is temporarily deactivated and the displayed speed setting flashes.

► Release the accelerator pedal to return to below the speed setting.

When exceeding the speed is not due to the driver's action (e.g. in case of a steep slope), an audible signal is triggered immediately.

! On a steep descent or in the event of sharp acceleration, the speed limiter will not be able to prevent the vehicle from exceeding the speed setting.
If necessary, apply the brakes to control your vehicle's speed.

When the vehicle speed returns to the speed setting level, the speed limiter operates again: the speed setting display becomes fixed again.

Off

► Press **1-LIMIT**: the speed limiter information display disappears.

Malfunction

In the event of a malfunction, dashes are displayed flashing and then fixed instead of the speed setting.

Have it checked by a CITROËN dealer or a qualified workshop.

Cruise control - Specific recommendations

! The cruise control function does not guarantee compliance with the maximum authorised speed and the safety distance between vehicles, the driver remains responsible for their driving.

In the interest of public safety, only use cruise control if the traffic conditions enable vehicles to drive at a steady speed and maintain an adequate safety distance.

Remain vigilant while cruise control is activated. If you press and hold one of the speed setting modification buttons, your vehicle may change speed very abruptly. When **descending a steep hill**, the cruise control system cannot prevent the vehicle from exceeding the set speed. Brake if necessary to control the vehicle speed. On **steep climbs** or when towing, the set speed may not be reached or maintained.

i Exceeding the programmed speed setting

You can **temporarily** exceed the speed setting by pressing the accelerator pedal (the programmed speed flashes).

To return to the speed setting, release the accelerator pedal (when the set speed is reached again, the displayed speed stops flashing).

! Operating limits

Never use the system in the following situations:

- In an urban area with the risk of pedestrians crossing the road.
- In heavy traffic (except versions with the Stop & Go function).
- On winding or steep roads.
- On slippery or flooded roads.
- In poor weather conditions.
- Driving on a speed circuit.
- Driving on a rolling road.
- When using snow chains, non-slip covers or studded tyres.

Cruise control

! For more information, refer to the **General recommendations on the use of driving and manoeuvring aids** and the **Cruise control - particular recommendations**.



This system automatically maintains the vehicle's speed at the value programmed by the driver (speed setting), without the use of the accelerator pedal.

Cruise control is switched on manually.

It requires a minimum vehicle speed of 25 mph (40 km/h).

With a manual gearbox, third gear or higher must be engaged.

With an automatic gearbox, mode **D** or second gear or higher in mode **M** must be engaged. With a drive selector, mode **D** or **B** must be engaged.

i Cruise control remains active after changing gear, regardless of the gearbox type, on engines fitted with the Stop & Start function.

i Switching off the ignition cancels any speed setting.

Steering-mounted controls



1. Cruise control selection
2. Switch on/pause cruise control at the previously saved speed setting

3. Increase/Decrease the speed setting (if cruise control activated)
Activation of cruise control in progress (if cruise control deactivated)
4. Activation of cruise control in progress
Use the speed suggested by the Road signs recognition

For more information on the **Road signs recognition** function, refer to the corresponding section.

Information displayed on the instrument panel

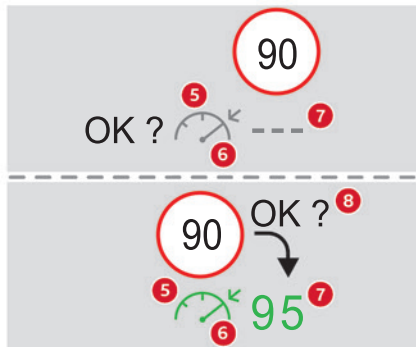

5. Cruise control mode selection indication
6. Cruise control on (green)/pause (grey) indication
7. Speed setting value

8. Speed suggested by the Road signs recognition function (depending on version)

Switching on/pausing

- ▶ Press button **1** to select the cruise control mode; the function is paused (grey).
- ▶ Press **3** upwards/downwards, or press **4-OK** to activate the cruise control and save a speed setting as soon as the vehicle speed reaches the desired level (green).
- ▶ Pressing button **2-I** temporarily pauses the function.
- ▶ Pressing **2-I** or **4-OK** again will reactivate cruise control (green).

- i** Cruise control operation is also temporarily interrupted (pause):
- by pressing the brake pedal.
 - automatically, if the electronic stability control (ESC) system is triggered.
 - by shifting to neutral or engaging reverse gear.
 - by using the electric parking brake.

Modifying the speed setting

The cruise control must be active.

To change the speed setting using the vehicle's current speed:

- ▶ For steps of +/- 1 mph (1 km/h), make successive short presses upwards/downwards on **3** to increase/decrease.

► For steps of +/- 5 mph (5 km/h), press and hold upwards/downwards on **3** to increase/decrease.

! Prolonged pressing and holding upwards/downwards on **3** causes a very rapid change in vehicle speed.

! As a precaution, we recommend setting a cruise speed fairly close to the current speed of your vehicle, to avoid any sudden acceleration or deceleration of the vehicle.

To change the speed setting using the speed suggested by the Road signs recognition displayed on the instrument panel:

– **When passing the sign:**

► Press **4-OK** to save the suggested speed.

This value is then immediately shown as the new speed setting on the instrument panel.

– **After passing the sign:**

► Press **4-OK**. The message “OK?” is displayed to confirm the request to save.

► Press **4-OK** again to save the suggested speed. The new speed setting value is displayed on the instrument panel.

Off

► Press **1**: the cruise control information display disappears.

Malfunction

In the event of a malfunction, dashes are displayed flashing and then fixed instead of the speed setting.

Have it checked by a CITROËN dealer or a qualified workshop.

Highway Driver Assist

Only available on versions with the EAT8 automatic gearbox and drive selector.

This system automatically adjusts the speed and corrects the trajectory of the vehicle, using Adaptive cruise control with Stop&Go function in conjunction with Lane Positioning Assist.

These two functions must be activated and in operation.

For more information on **Adaptive cruise control** and **Lane Positioning Assist**, refer to the corresponding sections.

! The system assists the driver by acting on the steering, acceleration and braking within the physical limits and capacities of the vehicle. Certain road infrastructure elements or vehicles in the surroundings may not be properly seen or may be poorly interpreted by the camera and radar, resulting in an unexpected change in direction, a lack of steering correction and/or inappropriate management of acceleration or braking.

! Primarily designed for driving on main roads and motorways, this system only works with moving vehicles driving in the same direction as your vehicle.

Adaptive cruise control

! For more information, refer to the **General recommendations on the use of driving and manoeuvring aids** and the **Cruise control - particular recommendations**.

This system automatically maintains the vehicle speed at a value set by the driver (speed setting), while respecting a safety distance from the vehicle in front (target vehicle) previously set by the driver. The system automatically manages the acceleration and deceleration of the vehicle. With the **Stop function**, the system manages braking until the vehicle comes to a complete stop.

With the **Stop & Go function**, the system manages braking until the vehicle comes to a complete stop and restarts the vehicle.

! The brake lamps come on if the vehicle is slowed down by the system. It can be dangerous to drive if the brake lamps are not in perfect working order.



To do this, the system uses a camera fitted at the top of the windscreen and a radar fitted in the front bumper.

! Primarily designed for driving on main roads and motorways, this system only works with moving vehicles driving in the same direction as your vehicle.

i If the driver activates the direction indicator to overtake a slower vehicle, cruise control may temporarily reduce the distance to the target vehicle to facilitate overtaking, without exceeding the speed setting.

Steering-mounted controls



1. Selection/deselection of cruise control only or Highway Driver Assist (depending on version)
2. Switch on/pause cruise control at the previously saved speed setting
Confirmation of vehicle restart after automatic stop (version with Stop & Go function)
3. Increase/Decrease the speed setting (if cruise control activated)
Activation of cruise control in progress (if cruise control deactivated)
Display and configuration of the inter-vehicle distance setting
4. Activation of cruise control in progress
Use the speed suggested by the Road signs recognition function

For more information on the **Road signs recognition** function, refer to the corresponding section.

Information displayed on the instrument panel

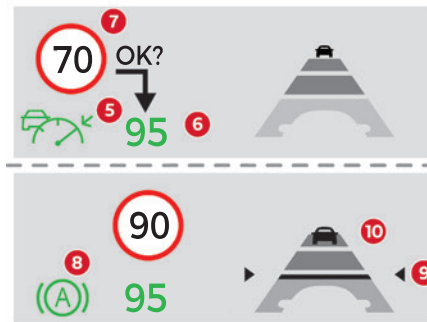

5. Cruise control activated (green)/paused (grey)
6. Speed setting value
7. Speed suggested by the Road signs recognition function
8. Vehicle held stationary (version with Stop&Go function)
9. Inter-vehicle distance setting
10. Position of the vehicle detected by the system

Use

Selecting the system

► With the engine running, press **1-ASSIST** to select cruise control mode.



The symbol for the Adaptive cruise control system is displayed on the instrument panel.

Switching on cruise control

With an EAT8 automatic gearbox or a drive selector, your speed must be between 0 and 112 mph (0 and 180 km/h).

System activation is also subject to the following conditions:

- driver's door closed.
- driver's seat belt fastened.
- mode **D** selected on the automatic gearbox.
- parking brake released.
- if the vehicle is stationary, brake pedal depressed.

▶ Press **3** or **4-OK**: the current speed becomes the speed setting (minimum 19 mph (30 km/h)) and cruise control is immediately activated (green display).

Modifying the speed setting

To change the speed setting using the vehicle's current speed:

- ▶ For steps of +/- 1 mph (1 km/h), make successive short presses upwards/downwards on **3** to increase/decrease.
- ▶ For steps of +/- 5 mph (5 km/h), press and hold upwards/downwards on **3** to increase/decrease.

! Prolonged pressing and holding upwards/downwards on **3** causes a rapid change in vehicle speed.

To change the speed setting using the speed suggested by the Road signs recognition function and displayed on the instrument panel:

– **When passing the sign:**

- ▶ Press **4-OK** to save the suggested speed.

This value is then immediately shown as the new speed setting on the instrument panel.

– **After passing the sign:**

- ▶ Press **4-OK**. The message "OK?" is displayed to confirm the request to save.
- ▶ Press **4-OK** again to save the suggested speed. The new speed setting value is displayed on the instrument panel.

Pausing/resumption of cruise control

▶ Press **2-I |>** or depress the **brake pedal**. The symbol turns grey.

Cruise control may also have been paused:

- automatically, if the electronic stability control (ESC) system is triggered.
- by shifting to neutral or engaging reverse gear.
- by using the electric parking brake.
- by unfastening the seat belt.
- by opening the driver's door.

▶ Press **2-I |>** or **4-OK** to reactivate cruise control.

With an EAT8 gearbox or a drive selector, following braking that has brought the vehicle to a complete stop, if the traffic conditions do not allow the vehicle to begin moving again within 3 seconds of stopping, press **2-I |>** or the accelerator pedal to move off.

i Cruise control remains active following a gear change.

! When cruise control is paused and the driver tries to reactivate it, the message "**Activation refused, conditions unsuitable**" is temporarily displayed if reactivation is impossible (required conditions not met).

Changing the programmed speed setting with the Road signs recognition function

▶ Press **4-OK** to accept the speed suggested by the function on the instrument panel, then press again to confirm.

! If the selected speed is far from the current vehicle speed, a strong acceleration or deceleration is felt.

Changing the inter-vehicle distance

▶ Press **3** to display the distance setting thresholds ("**Distant**", "**Normal**" or "**Close**"), then make successive short presses upwards/downwards to select a threshold. After a few seconds, the option is accepted and will be memorised when the ignition is switched off.

The driver must keep a sufficient safety distance from the vehicle in front.

Temporarily exceeding the speed setting

▶ Depress the accelerator pedal. The system is suspended as long as the acceleration is

maintained. The speed next to the symbol disappears from the instrument panel.

Deselecting the system

► Press **1-ASSIST** until the symbols disappear from the instrument panel.

Messages and alerts

i The actual order of display of the messages or alerts may be different.

- 

(grey symbol)
Cruise control selected, but cannot be activated.
All the operating conditions have not been met.
- 

(grey symbol)
Cruise control selected, awaiting activation.
All the operating conditions are met.
- 

(grey symbol)
Cruise control paused, but cannot be reactivated.
All the operating conditions have not been met.

 (green symbol)
Cruise control active, vehicle detected.

 (green symbol)
Cruise control suspended, following brief acceleration by the driver.

 (orange)
"Take back control"
► Brake or accelerate, depending on the context.

 (red)
"Take back control"
► **Take back control of the vehicle immediately:** the system cannot manage the current driving situation.

 "Activation refused, conditions unsuitable"
The system refuses to activate cruise control, as the necessary conditions are not fulfilled.

Stop & Go function

 (green symbols)
The system has brought the vehicle to a complete stop. The symbol "I I" is displayed.

Within 3 seconds of stopping, the vehicle gradually and automatically begins moving again.

Beyond 3 seconds of stopping, the driver must accelerate or press **2-I I** to move off.

i If the driver takes no action after the vehicle has been stopped, the electric parking brake is applied automatically after about 5 minutes.

! While the vehicle is immobilised, the following recommendations apply:

- The driver should not leave the vehicle.
- Do not open the boot.
- Do not drop off or pick up passengers.
- Do not engage reverse gear.

! When restarting the vehicle, beware of cyclists, pedestrians or animals who are not taken into account by the system. The driver must monitor their surroundings.

Operating limits

Cruise control operates by day and night, in dry weather or moderate rainfall.

Certain situations cannot be managed by the system and require driver intervention.

Cases not taken into account by the system:

- Pedestrians, cyclists, animals.
- Stationary vehicles (e.g. traffic jams, breakdown).

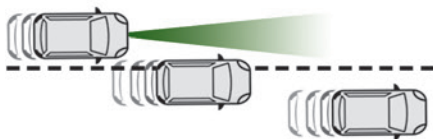

- Vehicles crossing your lane.
- Vehicles driving in the opposite direction.

Situations where the driver must suspend the system:

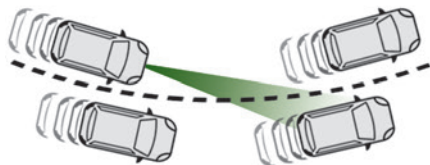

- Vehicles in a tight bend.
- When approaching a roundabout.

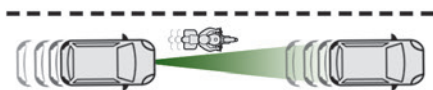

- When following a narrow vehicle.

Reactivate the system when conditions allow.

Situations in which the driver is prompted to immediately resume control:

- Excessively sharp deceleration by the vehicle in front of you.

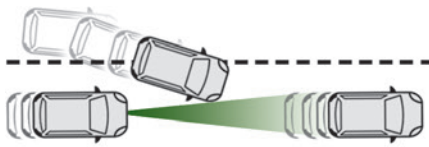

- When a vehicle cuts in sharply between your vehicle and the one in front.

! Some vehicles on the road may be poorly perceived or interpreted by the camera and/or the radar (e.g. truck), which can lead to an incorrect evaluation of distances and result in inappropriate acceleration or braking of the vehicle.

! Pay particular attention:

- When motorcycles are present and when there are vehicles staggered across the traffic lane.
- When entering a tunnel or crossing a bridge.

! If any of the following malfunctions occurs, do not use the system:

- Following an impact on the windscreen close to the camera or on the front bumper (versions with radar).
- Brake lamps not working.

! If the vehicle has undergone any of the following modifications, do not use the system:

- Carrying long objects on roof bars.
- Towing.
- Use of the "space-saver" type spare wheel (depending on version).
- Front end of the vehicle modified (for example by adding long-range headlamps or painting the front bumper).
- Obstructed radar and/or camera.

Malfunction



In the event of a malfunction, dashes are displayed instead of the speed setting.



This warning lamp comes on, accompanied by a message and an audible signal, to confirm the malfunction. Have it checked by a CITROËN dealer or a qualified workshop.

Lane positioning assist

! For more information, refer to the **General recommendations on the use of driving and manoeuvring aids.**

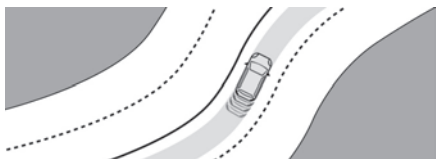

The system identifies the limits of the traffic lane and steers the vehicle inside this lane to maintain it in the lateral position chosen by the driver.

To do this, the system uses a camera placed on the upper part of the windscreen.

This function is primarily suitable for driving on motorways and main roads.

Activation/Deactivation

The Lane positioning assist system is automatically activated, after selecting Highway Driver Assist mode.

For more information on the **Highway Driver Assist** system, refer to the corresponding section.

The selection is confirmed by the display of the symbols on the instrument panel or on the head-up display (if fitted), representing the steering wheel and the side lines.

The colour of the symbols depends on the operating state of the system:



(grey)

One or more operating conditions is not met; the system is paused.



(green)

All operating conditions are met; the system is active.



(orange)

System malfunction.

If the driver no longer wishes to use the system for some time, they can deactivate it by pressing the button again (confirmed when the symbol disappears).



The system status is saved when the ignition is switched off.

Operating conditions

- Adaptive cruise control active.
- ESC system operational.
- ASR system activated.
- No trailer detected.
- No 'space-saver' spare wheel in use.
- Vehicle not subject to strong lateral g-forces.
- Direction indicators not activated.

Regulation

The driver must hold the steering wheel properly.

When regulation is activated, the symbols are displayed in green: with small steering inputs, the system steers the vehicle and keeps it in the position chosen by the driver in the traffic lane. This position is not necessarily the centre of the lane.

The driver can feel movements in the steering wheel.

At any time, the driver can change the position of the vehicle by intervening on the steering wheel and maintaining the position until the system has taken it into account. If the chosen position is too off-centre, an automatic re-centering manoeuvre can occur. The system adjusts to the newly defined position.

Pausing/Suspending the system



The driver must act promptly if they believe that the traffic conditions or the state of the road surface require their intervention, by moving the steering wheel to temporarily suspend system operation. Any action on the brake pedal that causes the Adaptive cruise control system to be paused will also cause the system to be paused.



If the system detects that the driver is not holding the wheel firmly enough, it triggers a series of gradual alerts and then deactivates itself if there is no response from the driver.



If the function is suspended due to the prolonged release of the force holding the steering wheel, the system must be reactivated by pressing the button again.

Automatic suspension

Suspension of the system is accompanied by a specific audible signal.

- Triggering of the ESC system.
- Insufficient lane detection. In this case, the Active lane departure warning system function can take over, and the system will reactivate

itself once the operating conditions are met again.

Paused by the driver





- Travelling outside the lane limits.
- Too tight a grip on the steering wheel or dynamic action on the steering wheel.









- Action on the brake pedal (resulting in a pause until cruise control is reactivated) or accelerator pedal (suspension for as long as the pedal is depressed).
- Pausing of the Adaptive cruise control system.
- Deactivation of the ASR system.









Driving situations and related alerts

The tables below describe the displays associated with the main driving situations. The actual order of display of these alerts may be different.

The locations of these symbols vary according to the display mode selected on the instrument panel and whether or not the head-up display is activated (if fitted to vehicle).

Symbols	Comments
 <p>(grey)</p> 	<p>Cruise control paused. Lane positioning assist not selected.</p>
 <p>(green)</p> 	<p>Cruise control on. Lane positioning assist not selected.</p>

Symbols	Comments
 <p>(green)</p>   <p>80</p> <p>(green)</p>  <p>(green lines)</p>	<p>Highway Driver Assist system activated. Lane positioning assist is operating normally (steering wheel correction active).</p>
 <p>(grey)</p>   <p>80</p> <p>(grey)</p> 	<p>Highway Driver Assist system paused by the driver.</p>

Symbols	Comments
 <p>(grey)</p>   <p>80 (green)</p> 	<p>Highway Driver Assist system activated. All the operating conditions for lane positioning assist have not been met.</p>
 <p>(grey)</p>   <p>(green)</p> 	<p>Highway Driver Assist system suspended. Cruise control and lane positioning assist are suspended.</p>

Messages	Driving situations
<p>"Keep your hands on the steering wheel"</p>	<p>Prolonged driving without holding the steering wheel, holding it improperly or without applying any force.</p>
<p>"Hold the steering wheel"</p>	<p>Actual or imminent loss of lane positioning assist.</p>
<p>"Take back control"</p>	<p>Simultaneous loss of cruise control and lane positioning assist.</p>

Operating limits

I The system may issue an alert when the vehicle is travelling on a long, straight road with smooth road surface even if the driver thinks they are holding the steering wheel correctly.

The system may not operate or may produce unsuitable corrections to the steering in the following situations:

- Poor visibility (insufficient road lighting, snowfall, rain, fog).
- Dazzle (headlamps of an oncoming vehicle, low sun, reflections on a wet road surface, leaving a tunnel, alternating light and shade).
- Windscreen area in front of the camera dirty, misted up, frost-covered, snow-covered, damaged or covered by a sticker.
- Lane markings eroded, partially hidden (snow, mud) or multiple (roadworks, surface joints).
- Travelling in a tight bend.
- Winding roads.
- Presence of a tarmac joint on the road.

Risk of undesirable operation

! The system should be deactivated in the following situations:

- Driving with a "space-saver" type spare wheel.
- When towing or with a bicycle carrier attached to a towing device, particularly when

a trailer is not connected or the trailer is not an approved type.

- Adverse weather conditions.
- Driving on slippery road surfaces (risk of aquaplaning, snow, ice).
- In roadworks or toll booth areas.
- Driving on racing circuits.
- Driving on a rolling road.

Malfunction



In the event of a malfunction, the Service warning lamp comes on and this (orange) symbol appears on the instrument panel, accompanied by the display of a message and an audible signal. Have it checked by a CITROËN dealer or a qualified workshop.

Active lane departure warning system

! For more information, refer to the **General recommendations on the use of driving and manoeuvring aids.**

The system corrects the vehicle's trajectory by alerting the driver as soon as it detects a risk of involuntary lane departure or crossing of a verge or hard shoulder (depending on version). To do this, the system uses a camera, placed on the upper part of the windscreen, identifying the

lane markings on the ground and the side of the road (depending on version).

This system is particularly useful on motorways and main roads.

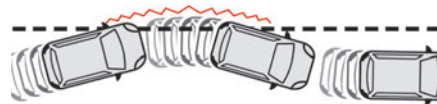

Operating conditions

- Vehicle speed between 40 and 112 mph (65 and 180 km/h).
- Road marked with a central dividing line.
- Steering wheel held in both hands.
- Direction indicators not activated.
- ESC system activated and operational.

! The system helps the driver only if there is a risk of the vehicle unintentionally wandering from the lane it is being driven in. It does not manage the safe driving distance, vehicle speed or braking. The driver must hold the steering wheel with both hands in a way that allows control to be maintained in circumstances where the system is not able to intervene (for example, if the central dividing line disappears).

Operation

As soon as the system identifies a risk of involuntarily crossing one of the lane markings

detected on the ground or a lane boundary (e.g. grass verge), it performs the trajectory correction necessary to restore the vehicle to its original lane.

The driver will notice a turning movement of the steering wheel.



This warning lamp flashes during trajectory correction.





The driver can prevent the correction by firmly holding the steering wheel (e.g. during an emergency manoeuvre). The correction is interrupted immediately if the direction indicators are operated.

While the direction indicators are activated and for a few seconds after switching them off, the system considers that a change of trajectory is intentional and no correction is triggered during this period.

Driving situations and related alerts

The table below describes the alerts and messages displayed in different driving situations.

These alerts are not displayed sequentially.

Function status	Display	Comments
OFF		Function deactivated.
ON	None.	Function active, conditions not met: <ul style="list-style-type: none"> – speed below 40 mph (65 km/h), – no lane marking recognised, – ESC operation triggered, – "sport" driving.
ON		Automatic deactivation/standby of the function (e.g. detection of a trailer, use of the "space-saver" spare wheel supplied with the vehicle, malfunction).
ON	None.	Lane marking detected. Speed above 40 mph (65 km/h).
ON		The system corrects the trajectory on the side where the risk of line crossing is detected. The driver's hands are on the steering wheel.

Function status	Display	Comments
ON	 "Hold the wheel".	<p>If, while correcting the trajectory, the system determines that the correction will not be enough and that a solid line will be crossed: the driver is warned that they must provide additional trajectory adjustment.</p> <p>If the steering wheel is not held properly, an audible warning sounds, accompanied by a message, until the trajectory correction is completed or the driver has grasped the steering wheel correctly.</p> <p>The duration of audible warnings will increase if multiple corrections are performed in quick succession. The warning will become continuous, persisting until the driver responds.</p>

Operating limits

The system goes into standby automatically in the following cases:

- ESC deactivated or operation triggered.
- Speed below 40 mph (65 km/h) or greater than 112 mph (180 km/h).
- Electrical connection to a trailer.
- Use of a "space-saver" spare wheel detected (as detection is not immediate, deactivation of the system is recommended).
- Dynamic driving style detected, pressure on the brake or accelerator pedal.
- Driving over lane markings.
- Activation of the direction indicators.
- Crossing the inside line on a bend.
- Driving on a tight bend.
- Inactivity by the driver detected during correction.
- Narrow lane detected.

- !** The following situations may interfere with the operation of the system or prevent it from working:
- Insufficient contrast between the road surface and the side of the road (e.g. shade).
 - Lane markings worn, hidden (snow, mud) or multiple (roadworks, etc.).
 - Close proximity to the vehicle in front (lane markings may not be detected).
 - Roads that are narrow, winding.

Risk of undesirable operation

The system should be deactivated in the following situations:

- When changing a wheel or working near a wheel.
- Towing or with a bicycle carrier on a towing device, especially with trailer not plugged in or not approved.

- Road in poor condition, unstable or with very poor grip (risk of aquaplaning, snow, ice).
- Adverse weather conditions.
- Driving on racing circuits.
- Driving on a rolling road.

Deactivation/Activation



- Press and hold this button to deactivate or press briefly to reactivate the system at any time.

 Deactivation is signalled by the lighting of the indicator lamp in the button and this warning lamp in the instrument panel.

The system is **automatically reactivated** every time the ignition is switched on.

Malfunction



In the event of a malfunction, these warning lamps light up on

the instrument panel, accompanied by the display of a message and an audible signal.

Have it checked by a CITROËN dealer or a qualified workshop.

Blind spot monitoring

! For more information, refer to the **General recommendations on the use of driving and manoeuvring aids.**

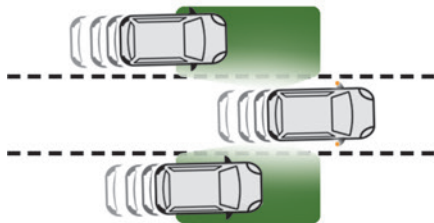

This system warns the driver of a potential danger posed by the presence of another vehicle (car, lorry, motorcycle) in the vehicle's blind spots (areas hidden from the driver's field of vision) using sensors located on the sides of the bumpers.

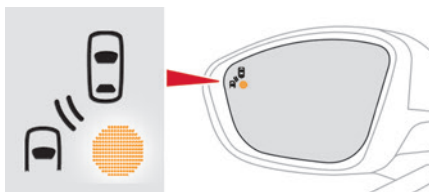

The warning is given by a fixed warning lamp that appears in the door mirror on the side in question:

- immediately, when being overtaken;
- after a delay of about one second, when overtaking a vehicle slowly.

Activation/Deactivation



It is set via the **Driving/Vehicle** touch screen menu.

When starting the vehicle, the warning lamp comes on in each mirror to indicate that the system is activated.

The status of the system is memorised when the ignition is switched off.

i The system is automatically deactivated when towing with a towing device approved by CITROËN.

Operating conditions

- All vehicles are moving in the same direction and in adjacent lanes.
- The speed of your vehicle must be between 7 and 87 mph (12 and 140 km/h) (versions

without Park Assist) or between 19 and 87 mph (30 and 140 km/h) (versions with Park Assist).

- When overtaking a vehicle, the speed difference is less than 6 mph (10 km/h).
- When overtaken by a vehicle, the speed difference is less than 16 mph (25 km/h).
- Traffic is flowing normally.
- Overtaking a vehicle over a certain period of time and the vehicle being overtaken remains in the blind spot.
- You are driving on a straight or slightly curved road.
- Your vehicle is not pulling a trailer, a caravan, etc.

Operating limits

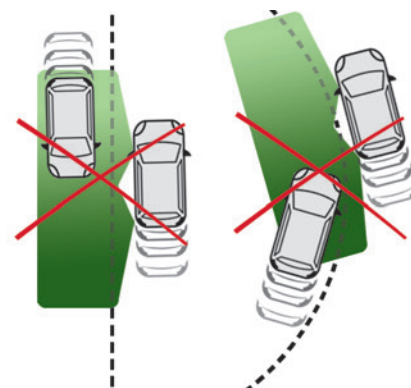

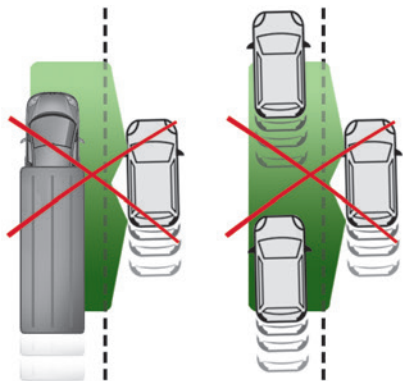

No alert is triggered in the following conditions:

- presence of stationary objects (e.g. parked vehicles, safety rails, lampposts, signs).
- vehicles travelling in the opposite direction.
- on winding roads or in case of sharp turns.
- when overtaking or being overtaken by a very long vehicle (e.g. truck, bus), which is both detected in a blind spot from behind and present in the driver's field of vision from the front.
- quick overtaking manoeuvre.
- very heavy traffic: vehicles detected in front and behind are confused with a lorry or a stationary object.
- activation of the Park Assist function.

Malfunction



If the event of a malfunction, this warning lamp comes on in the instrument panel, accompanied by the display of a message.

Have it checked by a CITROËN dealer or a qualified workshop.

i The system may be temporarily disturbed by certain climatic conditions (e.g. rain, hail).

In particular, driving on a wet road or going from a dry to a wet area can cause false alerts (e.g. presence of a cloud of water droplets in the blind spot interpreted as a vehicle).

In bad or wintry weather, ensure that the sensors are not covered by mud, ice or snow. Take care not to cover the warning zone in the door mirrors, or the detection zones on the front and rear bumpers with adhesive labels or other objects; they may hamper correct operation of the system.

Active Safety Brake with Collision Risk Alert and Intelligent emergency braking assistance

! For more information, refer to the **General recommendations on the use of driving and manoeuvring aids.**



This system:

- warns the driver that their vehicle is at risk of collision with the vehicle in front, a pedestrian or, depending on version, a cyclist.
- reduces the vehicle's speed to avoid a collision or limit its severity.

i The speed will be reduced by a maximum of 12 mph (20 km/h) (versions with camera only) or by a maximum of 31 mph (50 km/h) (versions with camera and radar).

i The system also takes motorcyclists into account.

This system is comprised of three functions:

- Collision Risk Alert.
- Intelligent emergency braking assistance (iEBA).
- Active Safety Brake (automatic emergency braking).

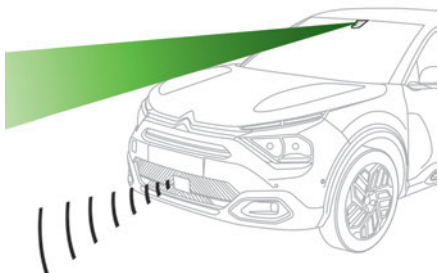

The vehicle has a multifunction camera located at the top of the windscreen and, depending on version, a radar located in the front bumper.

! This system does not replace the need for vigilance on the part of the driver.

This system is designed to assist the driver and improve road safety.

It is the driver's responsibility to continuously monitor traffic conditions in accordance with applicable driving regulations.

i As soon as the system detects a potential obstacle, it prepares the braking circuit in case automatic braking is needed. This may cause a slight noise and a slight sensation of deceleration.

Deactivation/Activation

By default, the system is automatically activated at every engine start.



The settings are changed via the **Driving/Vehicle** touch screen menu.



Deactivation of the system is signalled by the illumination of this warning lamp, accompanied by the display of a message.

Operating conditions and limits

Vehicle moving forward.

ESC system operational.

Seat belts fastened for all passengers.

Stabilised speed on roads with few bends.

In the following cases, deactivating the system via the vehicle's configuration menu is advised:

- Towing a trailer.
- Carrying long objects on roof bars.
- Vehicle with snow chains fitted.
- Before using an automatic car wash, with the engine running.
- Before placing the vehicle on a rolling road in a workshop.
- Towed vehicle, engine running.
- Following an impact to the windscreen close to the detection camera.



The system is automatically deactivated when the use of certain types of "space-saver" spare wheel (smaller diameter) is detected, or if a fault with the brake pedal switch or at least two brake lamps is detected.



It can be dangerous to drive if the brake lamps are not in perfect working order.



It is possible that warnings are not given, are given too late or seem unjustified.

The driver must always stay in control of the vehicle and be prepared to react at any time to avoid an accident.



Following an impact, the system is automatically deactivated.

Have it checked by a CITROËN dealer or a qualified workshop.

Collision Risk Alert

This function warns the driver that their vehicle is at risk of a collision with the vehicle in front, or with a pedestrian or cyclist present in their traffic lane.

Modifying the alert trigger threshold

This trigger threshold determines the sensitivity with which the function warns of the risk of collision.



The threshold is set via the **Driving/Vehicle** touch screen menu.

► Select one of the three pre-defined thresholds: "Far", "Normal" or "Close". The last threshold selected is memorised when the ignition is switched off.

Operation

Depending on the degree of risk of collision detected by the system and the alert trigger threshold chosen by the driver, several different

levels of alert may be triggered and displayed on the instrument panel.

The system takes account of the vehicle dynamics, the speed of your vehicle and the one in front, the environmental conditions and the operation of the vehicle (actions on the pedals, steering wheel, etc.) to trigger the alert at the most relevant moment.



Level 1 (orange): visual alert only, warning that the vehicle in front is very close.

The message "**Vehicle close**" is displayed.



Level 2 (red): visual and audible alert, warning that a collision is imminent.

The message "**Brake!**" is displayed.

Level 3: in some cases, a vibration alert in the form of micro-braking can be given, confirming the risk of collision.

Where the speed of your vehicle is too high approaching another vehicle, the first level of alert may not be displayed: the level 2 alert may be displayed directly.

Important: the level 1 alert is not displayed when there is a stationary obstacle or when the "**Near**" trigger threshold has been selected.

Intelligent emergency braking assistance (iEBA)

This function supplements braking in the event that the driver brakes, but not enough to avoid a collision.

This assistance will only be provided if the driver presses the brake pedal.

Active Safety Brake

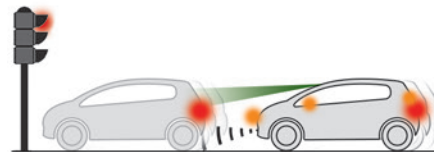

This function, also called automatic emergency braking, intervenes following the alerts if the driver does not react quickly enough and does not operate the vehicle's brakes.

The system aims to reduce the speed of impact or avoid a collision where the driver fails to react.

The speed will be reduced by a maximum of 12 mph (20 km/h) (versions with camera only) or by a maximum of 31 mph (50 km/h) (versions with camera and radar).

Operation

The system operates in the following speed ranges:

- Between 3 mph and 50 mph (5 km/h and 80 km/h) when a stationary vehicle is detected.
- Between 3 mph and 50 mph (5 km/h and 80 km/h) when a pedestrian is detected.
- Between 3 mph and 50 mph (5 km/h and 80 km/h) when a cyclist is detected (versions with camera and radar only).
- Between 3 mph and 50 mph (5 km/h and 80 km/h) (versions with camera only) or 87 mph (140 km/h) (versions with cameras and radar) when a moving vehicle is detected.



This warning lamp flashes (for approximately 10 seconds) as soon as the function applies the vehicle's brakes.

With an automatic gearbox or drive selector, in the event of automatic emergency braking bringing the vehicle to a complete stop, keep the brake pedal depressed to prevent the vehicle from moving off again.

With a manual gearbox, in the event of automatic emergency braking bringing the vehicle to a complete stop, the engine may stall.



i The driver can maintain control of the vehicle at any time by firmly turning the steering wheel and/or firmly depressing the accelerator pedal.



i The brake pedal may vibrate slightly while the function is operating. If the vehicle comes to a complete stop, automatic braking is maintained for 1 to 2 seconds.

Malfunction

 In the event of a malfunction, this warning lamp lights up on the instrument panel, accompanied by the display of a message and an audible signal.

Have it checked by a CITROËN dealer or a qualified workshop.

  If these warning lamps come on after the engine has been switched off and then restarted, contact a CITROËN dealer or a qualified workshop to have the system checked.

  These warning lamps light up on the instrument panel to indicate that the driver's and/or front passenger's seat belt is not fastened (depending on version). The automatic braking system is deactivated until the seat belts are fastened.

Distraction detection

! For more information, refer to the **General recommendations on the use of driving and manoeuvring aids.**

Depending on version, the function consists of either the "Coffee Break Alert" system alone or combined with the "Driver Attention Warning" system.

! These systems are in no way designed to keep the driver awake or to prevent the driver from falling asleep at the wheel. It is the driver's responsibility to stop if feeling tired. Take a break if you are feeling tired or at least every 2 hours.

Activation/Deactivation

 This function is set via the touch screen **Driving/Vehicle** menu. The function is activated by default when the ignition is switched on.

Coffee Break Alert

 The system triggers an alert when it detects that the driver has not taken a break after two hours of driving at a speed above 43 mph (70 km/h).

This alert is issued via the display of a message encouraging the driver to take a break, accompanied by an audible signal.

If the driver does not follow this advice, the alert is repeated hourly until the vehicle is stopped.

The system resets itself if one of the following conditions is met:

- With the engine running, the vehicle has been stationary for more than 15 minutes.
- The ignition has been switched off for a few minutes.
- The driver's seat belt is unfastened and their door is opened.

i As soon as the speed of the vehicle drops below 43 mph (70 km/h), the system goes into standby. Driving time starts being counted again once the speed reaches above 43 mph (70 km/h).

Driver Attention Warning

Depending on version, the Coffee Break Alert system may be combined with the Driver Attention Warning system.

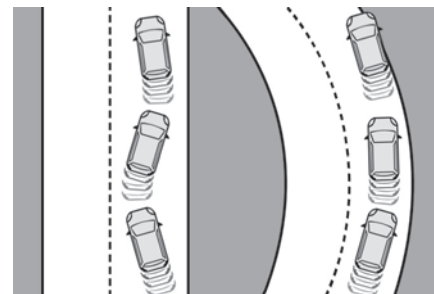



The system assesses the driver's level of alertness, fatigue and distraction by identifying trajectory changes in relation to the lane markings.

To do this, the system uses a camera, placed on the upper part of the windscreen.

This system is particularly suited to fast roads (speed higher than 43 mph (70 km/h)).

At a first alert level, the driver is warned by the message "**Be vigilant!**", accompanied by an audible signal.

After three first-level alerts, the system triggers a further alert with the message "**Dangerous driving: take a break!**", accompanied by a more pronounced audible signal.

In certain driving conditions (poor road surface or strong winds), the system may give alerts independent of the driver's level of vigilance.

The following situations may interfere with the operation of the system or prevent it from working:

- lane markings absent, worn, hidden (snow, mud) or multiple (roadworks);
- close to the vehicle ahead (lane markings not detected);
- roads that are narrow, winding, etc.

Parking sensors

For more information, refer to the **General recommendations on the use of driving and manoeuvring aids.**

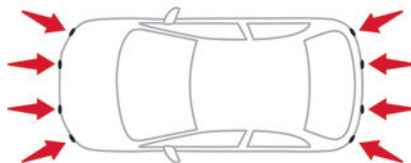

This system detects and signals the proximity of obstacles (e.g. pedestrian, vehicle, tree, barrier) using sensors located in the bumper.

Rear parking sensors

► Engage reverse gear to start the system (confirmed by an audible signal).

The system is switched off when reverse gear is disengaged.

Audible assistance

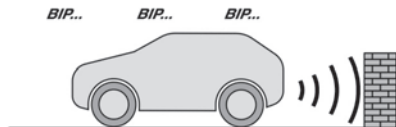

The system signals the presence of obstacles within the sensors' detection zone.

The proximity information is given by an intermittent audible signal, the frequency of which increases as the vehicle approaches the obstacle.

When the distance between the vehicle and the obstacle becomes less than about thirty centimetres, the audible signal becomes continuous.

The sound emitted by the speaker (right or left) indicates the side on which the obstacle is located.

Adjusting the audible signal



Depending on version, with CITROËN Connect Nav, pressing this button opens the window for adjusting the volume of the audible signal.

Visual assistance



This supplements the audible signal, without taking account of the vehicle's trajectory, by displaying bars on the screen that represent the distance between the obstacle and the vehicle (white: more distant, orange: close, red: very close).

When the obstacle is very close, the "Danger" symbol is displayed on the screen.

Front parking sensors

Supplementing the rear parking sensors, the front parking sensors are triggered when an obstacle is detected in front and the speed of the vehicle is below 6 mph (10 km/h).

Front parking sensor operation is suspended if the vehicle stops for more than three seconds in forward gear, if an obstacle is no longer detected or the vehicle speed exceeds 6 mph (10 km/h).

- i** The sound emitted by the speaker (front or rear) locates the obstacle relative to the vehicle, in front or behind it.

Side parking sensors



Using four additional sensors located on the sides of the bumpers, the system records the position of obstacles during the manoeuvre and indicates them when they are located alongside the vehicle.

! Only fixed obstacles are indicated correctly. Moving obstacles detected at the beginning of the manoeuvre may be indicated mistakenly, while moving obstacles that appear alongside the vehicle but were not previously recorded will not be indicated.

! Objects memorised during the manoeuvre will no longer be stored after switching off the ignition.

Deactivation/Activation



The settings are changed via the **Driving/Vehicle** touch screen menu.

The system status is memorised when the ignition is switched off.

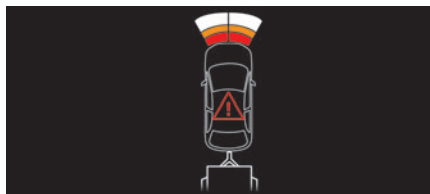

i The rear parking sensors system will be deactivated automatically if a trailer or bicycle carrier is connected to a towing device installed in accordance with the manufacturer's recommendations. In this case, the outline of a trailer is displayed at the rear of the image of the vehicle.

The parking sensors are deactivated while the Park Assist function is measuring a space. For more information on the **Park Assist** function, refer to the corresponding section.

- i** When starting the vehicle, the graphic and audible aids are only available after the touch screen has started up.

Operating limits

If the boot is heavily loaded, the vehicle may tilt, affecting distance measurements.

Malfunction



In the event of a malfunction when changing into reverse gear, this warning lamp lights up on the instrument panel, accompanied by the display of a message and an audible signal (short beep). Have it checked by a CITROËN dealer or a qualified workshop.

Reversing camera

- !** For more information, refer to the **General recommendations on the use of driving and manoeuvring aids.**

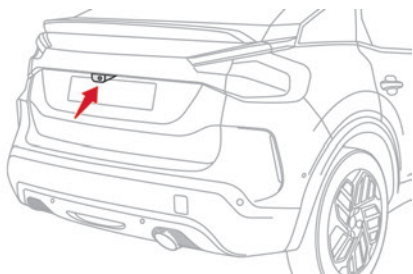

The reversing camera is activated automatically when reverse gear is engaged. The image is displayed on the touch screen.

i The reversing camera function may be supplemented by the parking sensors.

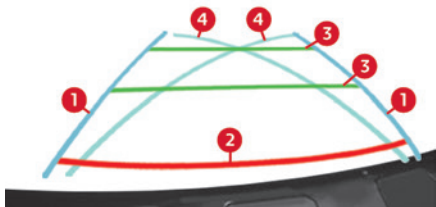

The blue lines **1** indicate the general direction of the vehicle (the gap corresponds to the width of your vehicle including the mirrors).

The red line **2** represents a distance of about 30 cm beyond the edge of your vehicle's rear bumper.

The green lines **3** represent distances of about 1 and 2 metres beyond the edge of your vehicle's rear bumper.

The turquoise curves **4** show the maximum turning angle in either direction.

! Opening the tailgate causes the display to disappear.

i Clean the reversing camera regularly using a soft, dry cloth.

Top Rear Vision - 360 vision

! For more information, refer to the **General recommendations on the use of driving and manoeuvring aids.**

With the engine running, these systems allow views of your vehicle's close surroundings to be displayed on the touch screen using one camera for Top Rear Vision and two cameras for 360 vision.

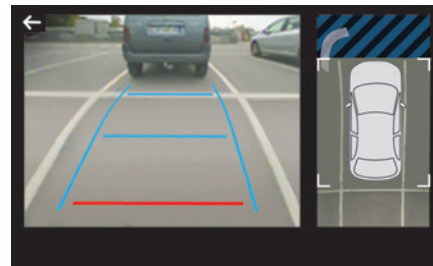

The screen is divided into two parts with a contextual view and a view from above the vehicle in its close surroundings.

The parking sensors supplement the information on the view from above the vehicle.

Various contextual views may be displayed:

- Standard view.
- 180° view.
- Zoom view.

AUTO mode is activated by default.

In this mode, the system chooses the best view to display (standard or zoom).

You can change the type of view at any time during a manoeuvre.

▶ Press the button in the bottom left-hand corner of the touch screen.

▶ Select the type of view:

- "Standard view".
- "180° view".

- "Zoom view".
- "AUTO view".

The display is immediately updated with the type of view selected.

The system status is not saved when the ignition is switched off.

Operating principle

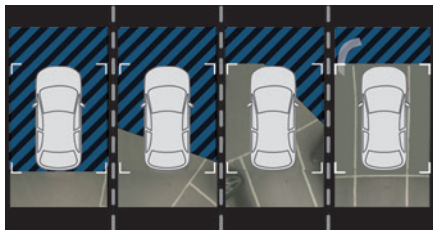

Using one or two cameras, the close surroundings of the vehicle are recorded whilst manoeuvring at low speed.

An image from above your vehicle in its close surroundings is reconstructed (represented by the brackets) in real time and as the manoeuvre progresses.

It facilitates the alignment of your vehicle when parking and allows obstacles close to the vehicle to be seen. It is automatically deleted if the vehicle remains stationary for too long.

With 360 vision, the image is created using both cameras, when going forward and when reversing.

When the function is activated, it is possible that the view from above is not displayed. If

the system is activated when the vehicle has already moved, the view from above can be fully displayed.

Top Rear Vision

Rear view



To activate the camera located near the number plate lamps, engage reverse gear and do not exceed a speed of 6 mph (10 km/h).

The system is deactivated:

- Automatically, at speeds above approximately 12 mph (20 km/h),
- Automatically, if the boot is opened.
- When changing out of reverse gear.
- By pressing the white arrow in the upper-left corner of the touch screen.

AUTO mode

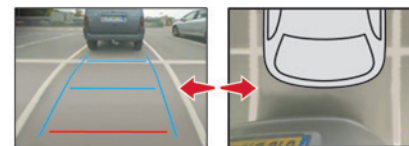

This mode is activated by default.

Using sensors in the rear bumper, the automatic view changes from the rear view (standard) to the view from above (zoom) as an obstacle is approached at the level of the red line (less than 30 cm) during a manoeuvre.

Standard view

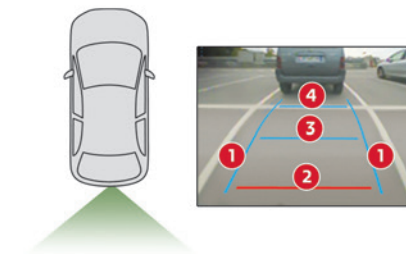

The area behind the vehicle is displayed on the screen.

The blue lines **1** represent the width of your vehicle, with the mirrors unfolded; their direction changes according to the position of the steering wheel.

The red line **2** represents a distance of 30 cm from the rear bumper; the two blue lines **3** and **4** represent 1 m and 2 m, respectively.

This view is available with AUTO mode or in the view selection menu.

Zoom view

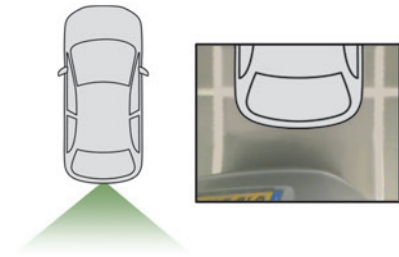

The camera records the vehicle's surroundings during the manoeuvre in order to create a view from above the rear of the vehicle in its near surroundings, allowing the vehicle to be manoeuvred around nearby obstacles. This view is available with AUTO mode or in the view selection menu.

i Obstacles may appear further away than they actually are.

It is important to monitor the sides of the vehicle during the manoeuvre, using the mirrors.

Parking sensors also provide additional information about the area around the vehicle.

180° view

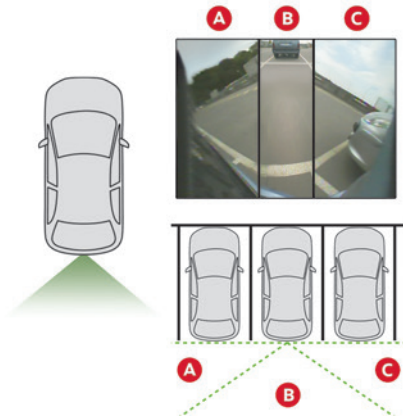

The 180° view facilitates reversing out of a parking space, making it possible to see the approach of vehicles, pedestrians and cyclists. This view is not recommended for carrying out a complete manoeuvre.

It features 3 areas: left **A**, centre **B** and right **C**.

This view is only available via the view selection menu.

360 vision

The vehicle has a camera at the front, fitted in the grille, and a camera at the rear, located close to the number plate lamps.

Using these cameras, the system displays the vehicle's near surroundings on the touch screen, offering views from the rear of the vehicle (rear vision) when reverse gear is engaged and views from the front of the vehicle (front vision) when the gearbox is in neutral or a gear is engaged.

Rear vision

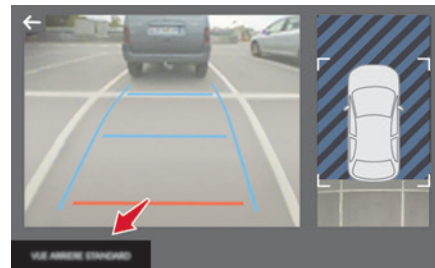

The system activates automatically when reverse gear is engaged.

The system is deactivated:

- Automatically, at speeds above approximately 12 mph (20 km/h),

- when shifting out of reverse (the rear view image is replaced by the front view image after 7 seconds).
- By pressing the white arrow in the upper-left corner of the touch screen.

I If a trailer or a bicycle carrier is fitted to the towball, the area behind the vehicle on the view from above goes dark. The surroundings are reconstructed by the front camera only.

The rear vision views are similar to those for the Top Rear Vision function.

For more information on the **Top Rear Vision** function, refer to the corresponding section.

Front and rear vision

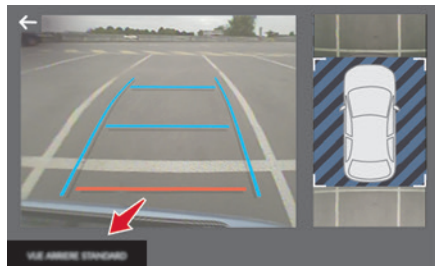

 With the engine running and the speed below 12 mph (20 km/h), the system is activated via the **Driving/Vehicle** touch screen menu:

► Select "Visual parking assistance".

AUTO mode is displayed by default, with front vision, if the gearbox is in neutral or with a gear engaged, or with rear vision, if reverse is engaged.

The system is deactivated:

- Automatically above about 19 mph (30 km/h) (the image disappears temporarily from 12 mph (20 km/h)).
- By pressing the white arrow in the upper-left corner of the touch screen.

AUTO mode

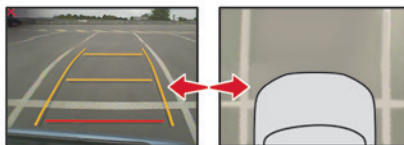

This mode is activated by default.

Using sensors in the front bumper, the automatic view changes from the front view (standard) to the view from above (zoom) as an obstacle is approached during a manoeuvre.

Standard view

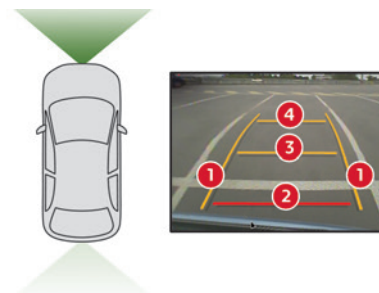

The area in front of your vehicle is displayed on the screen.

The orange lines 1 represent the width of your vehicle, with the mirrors unfolded; their direction changes according to the position of the steering wheel.

The red line 2 represents a distance of 30 cm from the front bumper; the two orange lines 3 and 4 represent 1 m and 2 m, respectively.

This view is available with AUTO mode or in the view selection menu.

Zoom view

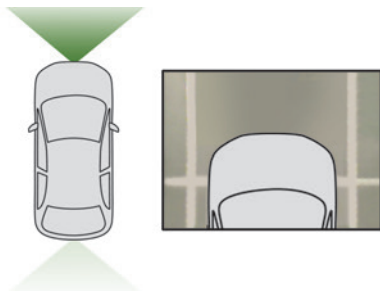

The camera records the vehicle's surroundings during the manoeuvre in order to create a view from above the front of the vehicle in its near surroundings, allowing the vehicle to be manoeuvred around obstacles nearby. This view is available with AUTO mode or in the view selection menu.

i Obstacles may appear further away than they actually are.

It is important to check the sides of the vehicle during the manoeuvre, using the mirrors.

The parking sensors also supplement the information on the vehicle's surroundings.

180° view

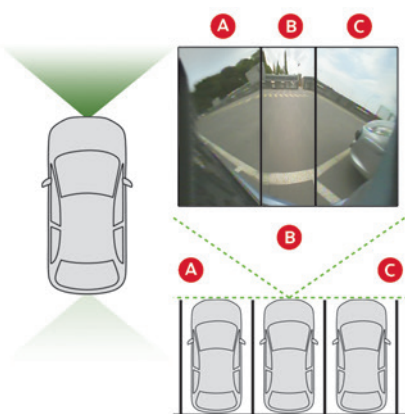

The 180° view assists with exiting from a parking space in forward gear, making it possible to see the approach of vehicles, pedestrians and cyclists.

This view is not recommended for carrying out a complete manoeuvre.

It consists of 3 areas: left **A**, centre **B** and right **C**.

This view is available only from the view selection menu.

Park Assist

! For more information, refer to the **General recommendations on the use of driving and manoeuvring aids**.

This system provides active parking assistance: it detects a parking space and then steers in the appropriate direction to park in the space while the driver controls the driving direction, gear changes, acceleration and braking.

To help the driver monitor the manoeuvre, the system automatically triggers the display from the Top Rear Vision or 360 vision function and activates the parking sensors.

The system measures the available parking spaces and calculates the distances to obstacles using ultrasonic sensors built into the front and rear bumpers of the vehicle.



The system assists with the following manoeuvres:

- A.** Entering a "parallel" parking space
- B.** Leaving a "parallel" parking space
- C.** Entering a "bay" parking space

Operation

► When approaching a parking area, reduce the speed of your vehicle to 19 mph (30 km/h) or less.

Activating the function



The function is activated in the **Vehicle/Driving** touch screen menu.

Select **"Park Assist"**.

! Activating the function deactivates the Blind spot monitoring system.

i You can deactivate the function at any time until the parking space entry or exit manoeuvre begins, by pressing the arrow located in the top left-hand corner of the display page.

Selecting the type of manoeuvre

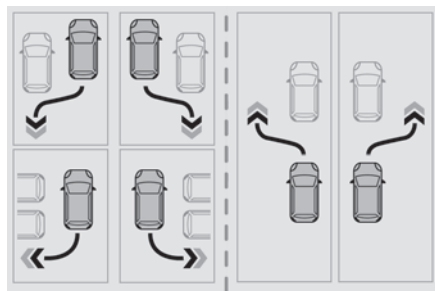

A manoeuvre selection page is displayed on the touch screen: by default, the "Entry" page if the vehicle has been running since the ignition was switched on, otherwise, the "Exit" page.

► Select the type and side of the manoeuvre to activate the parking space search. The selected manoeuvre can be changed at any time, even while searching for an available space.



This indicator lamp comes on to confirm the selection.

Parking space search

► You should drive at a distance of between 0.50 m and 1.50 m from the row of parked vehicles, without ever exceeding 19 mph (30 km/h), until the system finds an available space.

The parking space search stops over this limit. The function automatically deactivates once the vehicle speed exceeds 31 mph (50 km/h).

i For "parallel" parking, the space must at a minimum be equal to the length of your vehicle plus 0.60 m.

For "bay" parking, the width of the space must be equal to the width of your vehicle plus 0.70 m.

i If the parking sensors function has been deactivated in the **Driving/Vehicle** menu of the touch screen, it will be automatically reactivated when the system is activated.

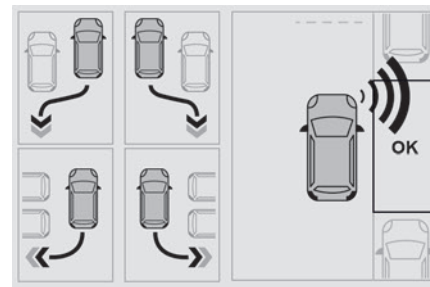

When the system finds an available space, "OK" is displayed on the parking view, accompanied by an audible signal.

Preparing for the manoeuvre

► Move very slowly until the request to stop the vehicle is displayed: **"Stop the vehicle"**, accompanied by the **"STOP"** sign and an audible signal.

Once the vehicle has stopped, an instructions page is displayed on the screen.

► To prepare for the manoeuvre, follow the instructions.

The start of the manoeuvre is indicated by the message **"Manoeuvre under way"**, accompanied by an audible signal.

Reversing is indicated by this message:

"Release the steering wheel, reverse".

The Top Rear Vision or Vision 360 function and the parking sensors are automatically

activated to help you monitor your vehicle's close surroundings during the manoeuvre.

During the manoeuvre

The system controls the vehicle's steering. It gives instructions on the manoeuvring direction when starting "parallel" entry and exit parking manoeuvres, and for all "bay" entry manoeuvres.

These instructions are displayed as a symbol accompanied by a message:



"Reverse".



"Go forwards".

The manoeuvring status is indicated by these symbols:



Manoeuvre in progress (green).



Manoeuvre cancelled or finished (red) (the arrows indicate that the driver must resume control of the vehicle).

The maximum speeds during manoeuvres are indicated by these symbols:



5 mph or 7 km/h, for parking space entry.



3 mph or 5 km/h, for parking space exit.

! During manoeuvring phases, the steering wheel performs rapid turns: do not hold the steering wheel or put your hands between the spokes of the steering wheel. Watch out for any objects that could interfere with the

manoeuvre (loose clothing, scarf, tie, etc.).

Risk of injury!

It is the driver's responsibility to constantly monitor the traffic, especially vehicles coming towards you.

The driver should check that no objects or people are obstructing the vehicle's path.

i The images from the camera(s) displayed on the touch screen may be distorted by the terrain.

In shady areas, or in inadequate sunlight or lighting conditions, the image may be darkened and with lower contrast.

The manoeuvre can be permanently interrupted at any time, either by the driver or automatically by the system.

Interruption by the driver:

- taking over control of the steering.
- activating the direction indicator lamps on the opposite side to that of the manoeuvre.
- unfastening the driver's seat belt.
- switching off the ignition.

Interruption by the system:

- vehicle exceeding the speed limit of 5 mph (7 km/h) during parking space entry manoeuvres, or 3 mph (5 km/h) during parking space exit manoeuvres.
- activation of anti-slip regulation on a slippery road.
- opening of a door or the boot.
- engine stall.

– system malfunction.

– after 10 manoeuvres to enter or exit a parallel parking space and after 7 manoeuvres to enter a parking bay.

Interrupting the manoeuvre automatically deactivates the function.

The manoeuvre symbol is displayed in red, accompanied by the "**Manoeuvre cancelled**" message on the touch screen.

A message prompts the driver to take back control of the vehicle.



The function is deactivated after a few seconds; this indicator lamp goes off and the function returns to the initial display.

End of the parking space entry or exit manoeuvre

The vehicle stops as soon as the manoeuvre is completed.

The manoeuvre symbol is displayed in red, accompanied by the message "**Manoeuvre completed**" on the touch screen.



When the function is deactivated, this indicator lamp goes off, accompanied by an audible signal.

When entering a parking space, the driver may be required to complete the manoeuvre.

Operating limits

- The system may suggest an inappropriate parking space (parking prohibited, work in progress with damaged road surface, location alongside a ditch, etc.).

- The system may indicate that a space has been found but will not offer it because of a fixed obstacle on the opposite side of the manoeuvre, which would not allow the vehicle to follow a trajectory required for parking.
- The system may indicate that a space has been found but the manoeuvre will not be triggered, because the width of the lane is insufficient.
- The system is not designed for performing the parking manoeuvre on a sharp bend.
- The system does not detect spaces that are much larger than the vehicle itself or that are delimited by obstacles that are too low (pavements, studs, etc.) or too thin (trees, posts, wire fences, etc.).
- If the boot is heavily loaded, the tilt of the vehicle towards the rear may interfere with the distance measurements.

- !** Do not use the function under the following exterior conditions:
- Alongside a soft shoulder (e.g. ditch) or quay or on the edge of a drop.
 - When the road surface is slippery (e.g. ice).

- !** If any of the following malfunctions occurs, do not use the system:
- If a tyre is under-inflated.
 - If one of the bumpers is damaged.
 - If one of the cameras is faulty.

- !** If the vehicle has undergone any of the following modifications, do not use the function:
- When carrying an object extending beyond the dimensions of the vehicle (ladder on the roof bars, bicycle carrier on the tailgate, etc.).
 - With a non-approved towball in place.
 - With snow chains fitted.
 - When driving on a small-diameter or "space-saver" type spare wheel.
 - When the wheels fitted are a different size from the original ones.
 - After modifying one or both bumpers (added protection).
 - If the sensors have been repainted other than by the CITROËN dealer network.
 - With sensors not approved for the vehicle.

Malfunctions



When the function is not activated, this indicator lamp will flash briefly and an audible signal will be emitted to indicate a system malfunction.

If the malfunction occurs while the system is in use, the warning lamp goes off.



If the parking sensor malfunction occurs during use, indicated by this warning lamp coming on and the display of a message, it causes the function to deactivate.

In the event of a malfunction, have the system checked by a CITROËN dealer or a qualified workshop.



In the event of a power steering malfunction, this warning lamp is displayed on the instrument panel, accompanied by a warning message. You must stop as soon as it is safe to do so. Contact a CITROËN dealer or a qualified workshop.

CITROËN prefers TOTAL



FILL UP WITH CONFIDENCE

WITH TOTAL QUARTZ LUBRICANTS

For more than 50 years, TOTAL and CITROËN have shared common values: excellence, creativity and technological innovation.

It is in this same spirit that TOTAL has developed a range of TOTAL QUARTZ lubricants adapted for engines in CITROËN vehicles, making them ever more fuel efficient and environmentally friendly.

TOTAL and CITROËN test the reliability and the performance of their products under extreme motorsport conditions.

Choose TOTAL QUARTZ lubricants when servicing your vehicle; they are your assurance of optimum engine life and performance.



Compatibility of fuels



Petrol fuels conforming to the EN228 standard containing up to 5% and 10% ethanol respectively.



Diesel fuels conforming to the EN590, EN16734 and EN16709 standards and containing up to 7%, 10%, 20% and 30% fatty acid methyl ester respectively. The use of B20 or B30 fuels, even occasionally, imposes special maintenance conditions referred to as "Arduous conditions".



Paraffinic Diesel fuel conforming to the EN15940 standard.

! The use of any other type of (bio) fuel (vegetable or animal oils, pure or diluted, domestic fuel, etc.) is strictly prohibited (risk of damage to the engine and fuel system).

i The only fuel additives authorised for use are those that meet the B715001 (petrol) or B715000 (Diesel) standards.

Diesel at low temperature

At temperatures below 0 °C (+32 °F), the formation of paraffins in summer-type Diesel

fuels could prevent the engine from operating correctly. In these temperature conditions, use winter-type Diesel fuel and keep the fuel tank more than 50 % full.

At temperatures below -15 °C (+5 °F) to avoid problems starting, it is best to park the vehicle under shelter (heated garage).

Travelling abroad

Certain fuels could damage your vehicle's engine.

In certain countries, the use of a particular fuel may be required (specific octane rating, specific trade name, etc.) to ensure correct operation of the engine.

For all additional information, consult a dealer.

Refuelling

Fuel tank capacity: approximately 50 litres.

Reserve level: approximately 6 litres.

Low fuel level

 When the low fuel level is reached, this warning lamp lights up on the instrument panel, accompanied by the display of a message and an audible signal. When it first comes on, **about 6 litres** of fuel remain.

Until sufficient fuel is added, this warning lamp appears every time the ignition is switched on, accompanied by an onscreen message and an audible signal. When driving, this message

and audible signal are repeated with increasing frequency as the fuel level drops towards **0**.

You must refuel as soon as possible to avoid running out of fuel.

For more information on **Running out of fuel (Diesel)**, refer to the corresponding section.

i A small arrow by the warning lamp indicates which side of the vehicle the fuel filler flap is located on.

! **Stop & Start**
Never refuel with the engine in STOP mode; you must switch off the ignition.

Refuelling

When refuelling, at least 5 litres must be added in order to be registered by the fuel gauge. Opening the filler cap may create a noise caused by an inrush of air. This vacuum is normal, caused by the sealing of the fuel system.

To refuel in complete safety:

▶ **Always switch off the engine.**

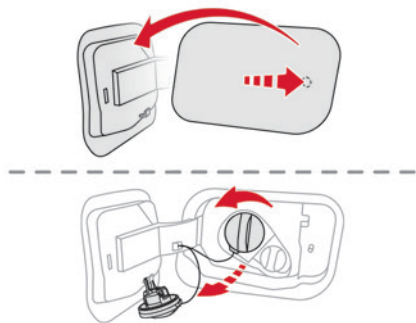

- ▶ With the vehicle unlocked, press the rear-central part of the filler flap to open it.
- ▶ Take care to select the pump that delivers the correct fuel type for your vehicle's engine (see a reminder label on the inside of the filler flap).
- ▶ Turn the filler cap to the left, remove it and place it on its support (on the filler flap).
- ▶ Insert the filler nozzle and push it in as far as possible before starting to refuel (to minimise the risk of splashing).

Do not continue after the nozzle's third cut-out. Doing so may cause malfunctions.

- ▶ Put the filler cap back in place and turn it to the right.
- ▶ Close the fuel filler flap.

! If you have put in the wrong fuel for the vehicle, you must have the fuel tank drained and filled with the correct fuel before starting the engine.

The vehicle is fitted with a catalytic converter, which helps to reduce the level of harmful emissions in the exhaust gases.

For petrol engines, you must use unleaded fuel.

The filler neck is narrower, admitting unleaded petrol nozzles only.

Misfuel prevention (Diesel)

(Depending on country of sale.)

This mechanical device prevents filling the tank of a Diesel vehicle with petrol.

Located in the filler neck, the misfuel prevention device is visible when the filler cap is removed.

Operation

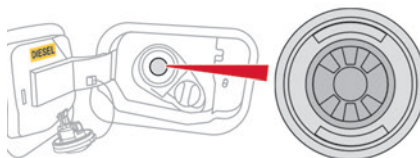

When a petrol filler nozzle is introduced into the fuel filler neck of a Diesel vehicle, it comes into contact with the flap. The system remains closed and prevents filling.

Do not persist but introduce a Diesel type filler nozzle.

- i** The use of a fuel jerrycan to fill the tank remains possible.

i Travelling abroad

As Diesel fuel pump nozzles may be different in other countries, the presence of the misfuel prevention device may make refuelling impossible.

Before travelling abroad, it is advisable to check with a CITROËN dealer if the vehicle is suitable for the distribution equipment of the countries visited.

Charging system (Electric)

400 V electrical system

The electric drive system, which operates at a voltage of approximately 400 V, is identified by orange cables and its components are marked with this symbol:



! An electric vehicle's power train can become hot during use and after switching off the ignition. Comply with the warning messages shown on the labels, particularly inside the charging flap.

! High voltage system voltage is dangerous and can cause burns or other injuries or even fatal electric shock. Since damage to high voltage components is not visible, CITROËN recommends that you:

- Never touch the components, damaged or not, and never let your jewelry or other metallic objects come into contact with these components.
- Never work on the orange high voltage cables or on any other high voltage component marked with the Electric risk label. Any intervention on the high voltage system must be carried out by qualified persons in workshops qualified and approved to carry out this type of work.
- Never damage, modify or remove the orange high voltage cables or disconnect them from the high voltage network.
- Never open, modify or remove the cover of the traction battery.
- Never work with cutting and forming tools or heat sources near high voltage components and cables.

In case of low level of fluid in the cooling tank, the refilling shall only be performed in a qualified and trained workshop to verify that the leakage is not in the traction battery. Any intervention on the high voltage system must be carried out by qualified persons in workshops qualified and approved to carry out this type of work.

Damage to the vehicle or the traction battery could result in the leakage of toxic gases or fluids either immediately or later. CITROËN recommends that you:

- Always inform the fire and emergency services in the event of an incident, warning that the vehicle is equipped with a traction battery.
- Never touch the liquids leaking from the traction battery.
- Do not inhale the gases emitted by the traction battery which are toxic.
- Move away from the vehicle in the event of incident or accident, the gases emitted being flammable and could cause a fire.

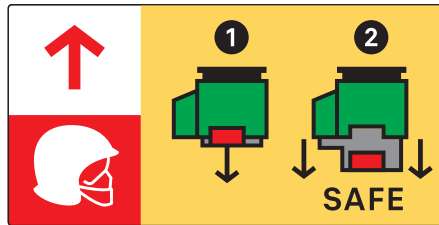

! This label is intended solely for use by firefighters and maintenance services in the event of any work on the vehicle. No other person must touch the device shown on this label.

! **In the event of an accident or impact to the vehicle's underbody**

In these situations, the electrical circuit or the traction battery can be seriously damaged. Stop as soon as it is safe to do so and switch off the ignition. Contact a CITROËN dealer or a qualified workshop.

! **When washing**

Before washing the vehicle, always check that the charging flap is closed correctly. Never wash the vehicle while the battery is on charge.

! **High-pressure washing**

To avoid damaging the electrical components, it is expressly prohibited to use high-pressure washing in the engine compartment or under the body. Do not use a pressure greater than 80 bar when washing the bodywork.

! Never allow water or dust to enter the connector or charging nozzle - risk of electrocution or fire!

Never connect / disconnect the charging nozzle or cable with wet hands - risk of electrocution!

Traction battery

This battery stores the energy that powers the electric motor and the thermal comfort equipment in the passenger compartment. It is discharged during use, and must therefore be regularly recharged. There is no need to wait for the traction battery to fall to its reserve level before recharging.

The range of the battery may vary according to the type of driving, the route, the use of thermal comfort equipment and the ageing of its components.

i The lifespan of the traction battery depends on multiple factors, such as climatic conditions, distance travelled and how often it has been fast-charged.

! To preserve the mileage of your vehicle and the durability of your traction battery, CITROËN recommends that you:

- Do not fully charge the battery of your electric vehicle daily (charge the traction battery below 80% as often as possible).
- Do not completely discharge the battery.
- Do not store the vehicle for a long period of non-use (more than 12 hours) when the traction battery has a low or high charge level. Prefer a charge level between 20 and 40%.
- Limit the use of fast charging.
- Do not expose the vehicle to temperatures below -30°C and above +60°C for more than 24 hours.

- Avoid charging the vehicle at negative temperatures (except if the vehicle ran more than 20 minutes) or above +30°C.
- Do not use the vehicle's traction battery as a generator of energy.
- Do not use a generator to recharge your vehicle's traction battery.

! In the event of damage to the traction battery

It is strictly prohibited to work on the vehicle yourself.

Do not touch liquids coming from the battery, and in the event of skin contact with these products, wash abundantly with water and contact a doctor as soon as possible.

Contact a CITROËN dealer or a qualified workshop to have the system checked.

Disposal of the traction battery

The traction battery is designed for the life of the vehicle if the recommendations of CITROËN are followed.

If it becomes necessary to replace the battery, contact the CITROËN dealer for instructions on its disposal. Improper disposal carries the risk of severe burns, electric shock, and damage to the environment.

In accordance with regulations, CITROËN ensures a second life or recycling of this component in collaboration with qualified operators.

Charging connectors and indicator lamps

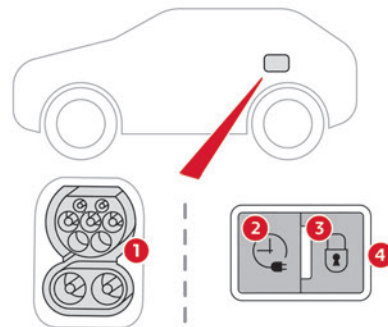

1. Charging connectors
2. Deferred charging activation button
3. Nozzle locking indicator lamp
Fixed red: nozzle positioned correctly and locked in the connector.
Flashing red: nozzle incorrectly positioned or locking not possible.
4. Charging indicator lamp



State of charging indicator lamp	Meaning
Fixed white	Welcome lighting on opening the flap and disconnecting the charging cable.
Fixed blue	Deferred charging.
Flashing green	Charging.
Fixed green	Charging complete. The charging indicator lamp goes off after about 2 minutes as the vehicle's functions go into standby. The indicator lamp comes on again when the vehicle is unlocked with the Keyless Entry and Start system or when a door is opened to indicate that the battery is fully charged.

State of charging indicator lamp	Meaning
Fixed red	Malfunction.

! In case of impact, even light, against the charging flap, do not use it.

Do not dismantle or modify the charging connector - risk of electrocution and/or fire!
Contact a CITROËN dealer or a qualified workshop.

Charging cables, sockets and chargers

The charging cable supplied with the vehicle (depending on version) is compatible with the electrical systems in the country of sale. When travelling abroad, check the compatibility of local electrical systems with the charging cable. A full range of charging cables is available from your dealer.

Contact a CITROËN dealer or a qualified workshop for more information and to obtain suitable charging cables.

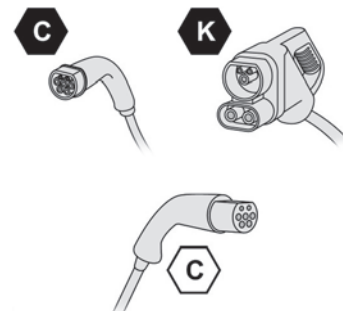

Identification labels on charging sockets/connectors

Identification labels are affixed to the vehicle, charging cable and charger to inform the user about which device needs to be used.



The meaning of each identification label is as follows:

Identification label	Location	Configuration	Power type/Voltage range
	Charging connector (vehicle side)	TYPE 2	AC < 480 Vrms

Identification label	Location	Configuration	Power type/Voltage range
	Charging socket (charger side)	TYPE 2	AC < 480 Vrms
	Charging connector (vehicle side)	COMBO 2 (FF)	DC 50 V – 500 V

Standard charging, mode 2

Domestic socket

(standard charging - alternating current (AC))



Mode 2 with a standard socket: 8 A maximum charging current.



Mode 2 with a Green'Up socket: 16 A maximum charging current.

To have this type of socket installed, call a professional installer.

Specific domestic charging cable - mode 2 (AC)

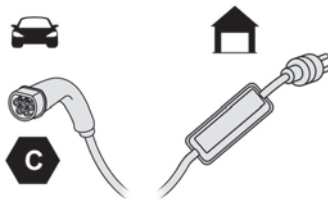

Identification label **C** on the charging connector (vehicle side).

! Specific domestic charging cable (mode 2)

You must not damage the cable. In the event of damage, do not use it and contact a CITROËN dealer or a qualified workshop to replace it.

Control unit (mode 2)

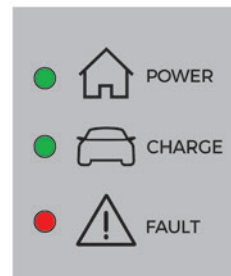
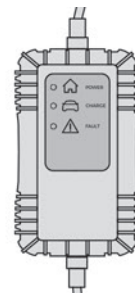

POWER

























Green: electrical connection established; charging can begin.

CHARGE

Flashing green: charging in progress or temperature pre-conditioning activated. Fixed green: charging complete.

FAULT

Red: fault; charging not permitted or must be stopped immediately. Check that everything

POWER	CHARGE	FAULT	Symbol	Description
 (green)	 (green)	 (red)		The control unit is currently performing a self-test.
 (green)				Connected only to the infrastructure or to the infrastructure and to the Electric Vehicle (EV) but no charging in progress.
 (green)	 (green)			Connected to the power supply and to the Electric Vehicle (EV). The EV is on charge or in a temperature pre-conditioning sequence.
 (green)	 (green)			Connected to the power supply and to the Electric Vehicle (EV). The EV is waiting for charging or the charging of the EV is completed.
		 (red)		Control unit malfunction. No charging allowed. If an error indicator reappears after a manual reset, the control unit must be checked by a CITROËN dealer before the next charge.
 (green)	 (green)	 (red)		The control unit is in diagnostic mode.

Manual reset procedure

The control unit can be reset by simultaneously disconnecting the charging connector and the wall socket. Then, reconnect the wall socket first. For more information, refer to the handbook.

Accelerated charging, mode 3

Accelerated charging unit (depending on version)
(accelerated charging - single-phase or three-phase alternating current (AC))

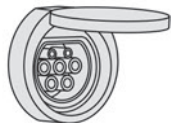

In mode 3 with an accelerated charging unit: 32 A maximum charging current.



In mode 3 with an accelerated charging unit (Wallbox): 32 A maximum charging current.

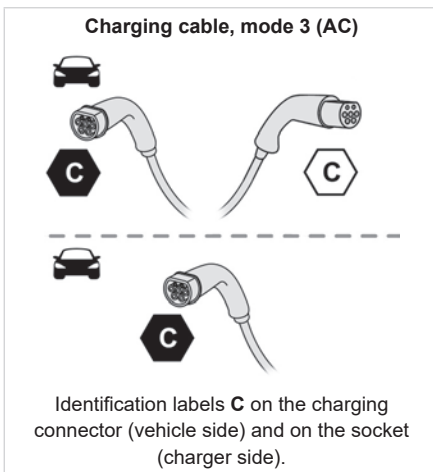

! **Accelerated charging unit**
Do not disassemble or modify the charging unit - risk of electrocution and/or fire! Refer to the charging unit manufacturer's user manual for the operating instructions.

Superfast charging, mode 4

Fast public charger
(superfast charging - direct current (DC))

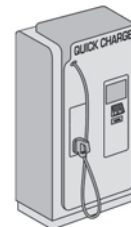

Charging cable, mode 4 (DC)
(integrated into the fast public charger)

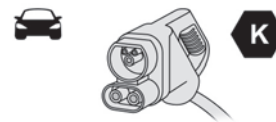

Identification label **K** on the charging connector (vehicle side).
Only use fast public chargers where the cable length does not exceed 30 metres.

Charging the traction battery (Electric)

To recharge, connect the vehicle to a domestic electricity supply (domestic or accelerated charging) or to a fast public charger (superfast charging).

For a full charge, follow the desired charging procedure without pausing it, until it ends automatically. Charging can be either immediate or deferred (except fast public charger, mode 4). You can stop domestic or accelerated charging at any time by unlocking the vehicle and removing the nozzle. For superfast charging, refer to the fast public charger.

For more information on the charging displays on the **Instrument panel** and the **Touch screen**, refer to the corresponding section.

I It is also possible to monitor the charging progress using the **MyCitroën App** application.

For more information on **Remote functions**, refer to the corresponding section.

! As a safety measure, the engine will not start if the charging cable is plugged into the connector on the vehicle. A warning is displayed on the instrument panel.

I **Cooling the traction battery**
The cooling fan in the engine compartment comes on during charging to cool the on-board charger and the traction battery.

! **Low load / Driving**
Driving when the charge level of the traction battery is too low can lead to the vehicle breaking down and can lead to

accidents or serious injuries. **ALWAYS** make sure the traction battery has a sufficient charge level.

! **Low load / Parking**
If the outside temperature is negative, it is recommended not to park your vehicle outside for several hours at a low load (less than 20%).

! **Vehicle in storage for more than 1 month**
In the event of a long period of non-use of the vehicle (beyond 4 weeks) without the possibility of charging when restarting, the self-discharge may make it impossible to restart if the traction battery charge level is a low or very low, especially at negative ambient temperatures. **ALWAYS** make sure that the traction battery has a charge between 20% and 40% if you do not plan to use your vehicle for several weeks.

Do not connect the charging cable. Always park the vehicle in a place with temperatures between -10°C and 30°C (parking in a place with extreme temperatures can damage the traction battery). Disconnect the cable from the (+) terminal of the accessory battery in the engine compartment.
Connect a 12 V battery charger to the (+) and (-) terminals of the accessory battery

about every 3 months in order to recharge the accessory battery and maintain an operating voltage.

Precautions

Our electric vehicles have been developed in accordance with the recommendations on the maximum limits for electromagnetic fields, as issued by the International Commission on Non-Ionizing Radiation Protection (ICNIRP - 1998 Guidelines).

Wearers of pacemakers or equivalent devices



Ask your doctor about what precautions you should take, or ask the manufacturer of your implanted electro-medical device about whether its operation is guaranteed in an environment which complies with the ICNIRP recommendations.

! **If in doubt**
Domestic or accelerated charging: do not remain inside or near the vehicle, or near the charging cable or charging unit, even for a short time.

Superfast charging: do not use the system yourself and avoid approaching public fast charging points. Leave the area and ask a third party to recharge the vehicle.

For domestic or accelerated charging

! Before charging

Depending on the context:

- ▶ Have a professional check that the electrical system to be used complies with applicable standards and is compatible with the vehicle.
 - ▶ Have a professional electrician install a dedicated domestic power socket or accelerated charging unit (Wallbox) compatible with the vehicle.
- You should preferably use the charging cable available as an accessory.
- For more information, contact a CITROËN dealer or a qualified workshop.

! During charging

While charging is in progress, unlocking the vehicle will cause the charging to stop. If no action is taken on one of the openings (door or boot) or on the charging nozzle, the vehicle will lock again after 30 seconds and charging will resume automatically. Never work under the bonnet:

- Some areas remain very hot, even an hour after charging ends - risk of burns!
- The fan may start at any time - risk of cuts or strangulation!

! After charging

Check that the charging flap is closed.

Do not leave the cable connected to the domestic power socket - risk of short-circuit or electrocution in the event of contact with or immersion in water!

For superfast charging

i Before charging

Check that the fast public charging station and its charging cable are compatible with the vehicle.

If the exterior temperature is below:

- 0°C, charging times may be extended.
- -20°C, charging is still possible, but charging times may be extended even further (the battery has to be heated first).

! After charging

Check that the charging flap is closed.

Connection

- ▶ Before charging, check that the drive selector is in mode **P**, otherwise charging is not possible.
- ▶ Open the charging flap by pressing the push-button, and check that there are no foreign bodies on the charging connector.

Domestic charging, mode 2

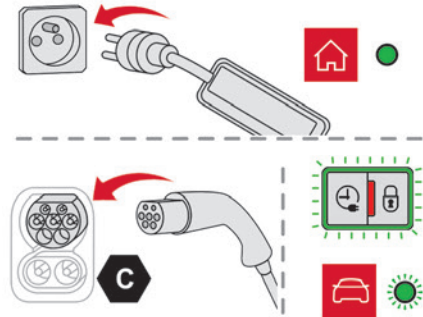

- ▶ Connect the charging cable from the control unit to the domestic socket.

When the connection is made, all of the indicator lamps on the control unit light up, then only the **POWER** indicator lamp remains on in green.

- ▶ Remove the protective cover from the charging nozzle.
- ▶ Insert the nozzle into the charging connector. The start of charging is confirmed by the flashing green **CHARGE** indicator lamps in the flap, then those on the control unit.

If this is not the case, charging has not started; restart the procedure, ensuring that all connections are properly established. The red indicator lamp in the flap comes on to indicate that the nozzle is locked.

- i When charging is complete and while the charging cable is still connected, opening

the driver's door will display the charge level on the instrument panel for about 20 seconds.

Accelerated charging, mode 3



- ▶ Follow the accelerated charging unit (Wallbox) user instructions.
- ▶ Remove the protective cover from the charging nozzle.
- ▶ Insert the nozzle into the charging connector. The start of charging is confirmed when the charging indicator lamp in the flap flashes green. If this is not the case, charging has not started; restart the procedure, ensuring that the connection has been properly established. The red indicator lamp in the flap comes on to indicate that the nozzle is locked.

Superfast charging, mode 4



- ▶ Depending on version, remove the protective cover from the lower part of the connector.

- ▶ Follow the instructions for use of the fast public charger and connect the cable from the fast public charger to the vehicle's connector. The start of charging is confirmed by the flashing green charging indicator lamp in the flap. If this is not the case, charging has not started; restart the procedure, ensuring that the connection is properly established. The red indicator lamp in the flap comes on to indicate that the nozzle is locked.

Deferred charging

Settings

At a CITROËN dealer or qualified workshop, with touch screen BLUETOOTH audio system

By default, the deferred charging start time is set to midnight (vehicle time). You can have the deferred charging start time modified.

Visit a CITROËN dealer or a qualified workshop.

On a smartphone or tablet

 You can programme the deferred charging function at any time via the **MyCitroën App** application.

For more information on **Remote functions**, refer to the corresponding section.

In the vehicle, with 10-inch touch screen

- ▶ In the **Energy** touch screen menu, select the **Charge** page.
- ▶ Set the charging start time.

- ▶ Press **OK**. The setting is saved in the system.

Activation

 Deferred charging is only possible with modes 2 and 3.

- ▶ After programming the deferred charging, connect your vehicle to the desired charging equipment.



- ▶ Press this button in the flap within one minute to activate the system (confirmed by the charging indicator lamp coming on in blue).

Disconnection



Before disconnecting the nozzle from the charging connector:

- ▶ If the vehicle is unlocked, **lock it and then unlock it**.
- ▶ If the vehicle is locked, unlock it. The red indicator lamp in the flap goes out to confirm that the charging nozzle is unlocked.

► Within **30 seconds**, remove the charging nozzle.
The charging indicator lamp comes on in white.

i With selective door unlocking activated, press the unlocking button twice to disconnect the charging nozzle.

i When charging is complete, the green charging indicator lamp in the flap goes out after about 2 minutes.

Domestic charging, mode 2

The end of charging is confirmed when the green **CHARGE** indicator lamp on the control unit and the green charging indicator lamp in the flap come on fixed.

- Replace the protective cover on the charging nozzle and close the charging flap.
- Disconnect the control unit end of the charging cable from the domestic socket.

Accelerated charging, mode 3

The end of charging is indicated by the charging control unit and by the fixed lighting of the green indicator lamp in the flap.

- Hang up the nozzle on the charging unit and close the charging flap.

Superfast charging, mode 4

The end of charging is indicated by the charger and by the fixed lighting of the green indicator lamp in the flap.



► You can also pause charging by pressing this button in the flap (in mode 4 only).

- Hang up the nozzle on the charger.
- Depending on version, replace the protective cover on the lower section and close the charging flap.

i When the charging nozzle is disconnected, a message on the instrument panel indicates that charging is complete, even if the charging nozzle was disconnected before full charging was completed.

Towing device

Load distribution

► Distribute the load in the trailer so that the heaviest items are as close as possible to the axle, and the nose weight approaches the maximum permitted without exceeding it. Air density decreases with altitude, thus reducing engine performance. The maximum towable load must be reduced by 10% per 1,000 metres of altitude.

i Use genuine towing devices and wiring harnesses approved by CITROËN. We

recommend having them fitted by a CITROËN dealer or a qualified workshop.

If not fitted by a CITROËN dealer, they must still be fitted in accordance with the vehicle manufacturer's instructions.

Certain driving or manoeuvring aid functions are automatically deactivated while an approved towing system is in use. For more information about driving with a towing device fitted to a trailer and associated with the **Trailer stability assist**, refer to the corresponding section.

! Comply with the maximum authorised towable weight, as indicated on your vehicle's registration certificate, on the manufacturer's label and in the **Technical data** section of this guide.

! If using accessories attached to the towing device (e.g. bicycle carriers, tow boxes):

- Comply with the maximum authorised nose weight.

- Do not transport more than 3 bicycles.

When loading bicycles on to a bicycle carrier over the towball, be sure to place the heaviest bicycles as close as possible to the vehicle.

! Observe the legislation in force in the country where you are driving.

i Electric motor

An electric vehicle cannot under any circumstances be fitted with a towing device. It is therefore not possible to tow a trailer or caravan.

Towing device with quickly detachable towball

Presentation

No tools are required to install or remove this genuine towing device.

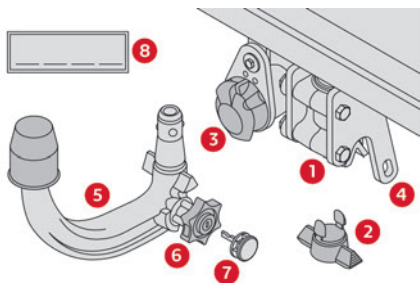

1. Carrier
2. Protective plug
3. Connection socket
4. Safety eye
5. Detachable towball
6. Locking/unlocking wheel
7. Security key lock

8. Label to note the key references

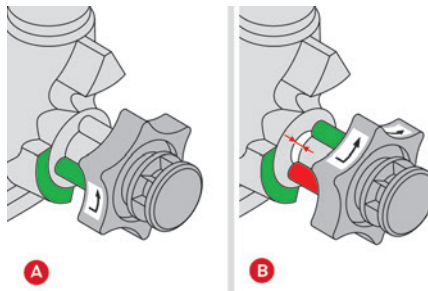

A. Locked position (the **green** marks are opposite each other); the wheel is in contact with the towball (no gap).

B. Unlocked position (**red** mark opposite the **green** mark); the wheel is no longer in contact with the towball (gap of around 5 mm).

i Affix the enclosed label in a clearly visible location, close to the carrier or in the boot.

! Trailers with LED lamps are not compatible with the wiring harness of this device.

i To ensure complete safety while driving with a **Towing device**, refer to the corresponding section.

! Before each use

Verify that the towball is correctly fitted, checking the following points:

- The green mark on the wheel is in line with the green mark on the towball.
- The wheel is in contact with the towball (position **A**).
- The security key lock is closed and the key removed; the wheel can no longer be operated.
- The towball must not be able to move in its carrier; test by attempting to shake it with your hand.

If the towball is not locked, the trailer can become detached - risk of an accident!

! During use

Never release the locking system with a trailer or load carrier on the towball. Never exceed the maximum authorised weight for the vehicle - the Gross Train Weight or GTW. Always comply with the maximum authorised load on the towing device: if it is exceeded, this device may become detached from the vehicle - risk of an accident! Before driving, check the headlamp height adjustment and check that the lamps on the trailer operate correctly.

For more information on **Headlamp height adjustment**, refer to the corresponding section.

! After use

When travelling without a trailer or load carrier, remove the towball and fit the protective plug into the carrier, to provide clear visibility of the number plate and/or its lighting.

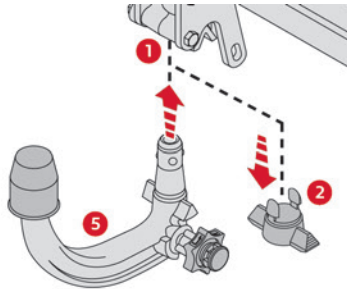
Fitting the towball

- ▶ Below the rear bumper, remove the protective plug **2** from the carrier **1**.
- ▶ Insert the end of the towball **5** into the carrier **1** and push it upwards; it will lock into position automatically.

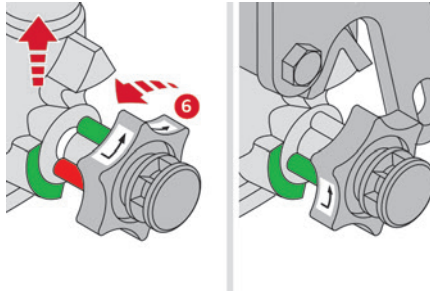

- ▶ The wheel **6** rotates a quarter turn anti-clockwise; take care to keep your hands clear!

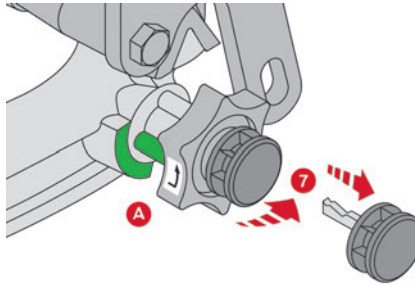

- ▶ Check that the mechanism has correctly locked into place (position **A**).
- ▶ Close the lock **7** using the key.
- ▶ Remove the key. The key cannot be removed while the lock is open.
- ▶ Clip the cap onto the lock.

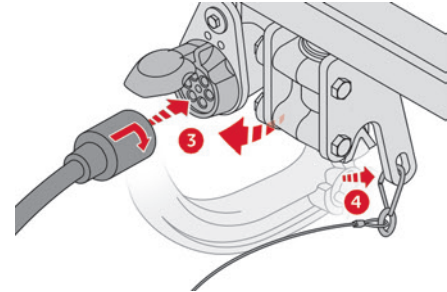

- ▶ Remove the protective cover from the towball.
- ▶ Attach the trailer to the towball.
- ▶ Attach the cable on the trailer to the safety eye **4** on the carrier.
- ▶ Lower the connection socket **3** to put it in position.
- ▶ Insert the trailer plug and rotate it by a quarter turn to connect it to the connection socket **3** on the carrier.

Removing the towball

- ▶ Grasp the trailer's plug, perform a quarter turn and pull to disconnect it from the connection socket **3** on the carrier.
- ▶ Lift the connection socket **3** to the right to stow it away.
- ▶ Detach the trailer's safety cable from the safety eye **4** on the carrier.
- ▶ Unhitch the trailer from the towball.
- ▶ Replace the protective cover over the towball.

- ▶ Remove the cap from the lock and press it onto the head of the key.

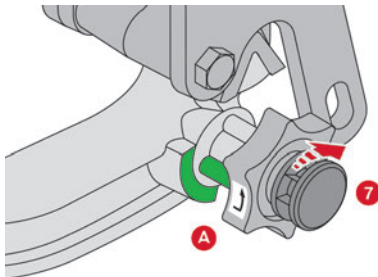

- ▶ Insert the key into the lock 7.
- ▶ Open the lock using the key.

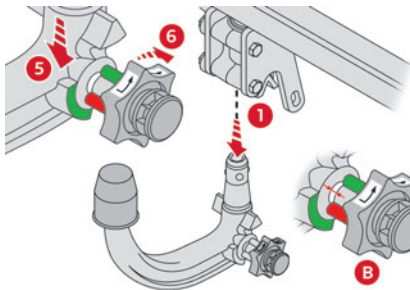

- ▶ Hold the towball 5 firmly in one hand; using the other hand, pull and turn the wheel 6 fully in a clockwise direction until it stops; do not release the wheel.
- ▶ Extract the towball from the base of its carrier 1.

- ▶ Release the wheel; it automatically locks in the unlocked position (position B).

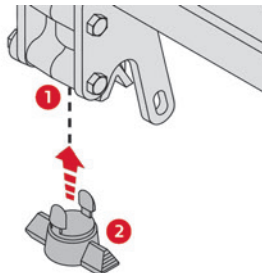

- ▶ Replace the protective plug 2 into the carrier 1.
- ▶ Stow the towball in its bag to protect it from knocks and dirt.

Maintenance

Correct operation is only possible if the towball and its carrier are kept clean. Before cleaning the vehicle with a high-pressure jet wash, the towball must be removed and the protective plug fitted to the carrier.

i Work on the towing device
Contact a CITROËN dealer or a qualified workshop.

Roof bars

! As a safety measure and to avoid damaging the roof, it is essential to use transverse roof bars approved for your vehicle. Observe the instructions on fitting and use contained in the guide supplied with the roof bars.

! Maximum load distributed over the transverse roof bars, for a loading height not exceeding 40 cm (except bicycle carrier): **80 kg.**

As this value may change, please verify the maximum load quoted in the guide supplied with the roof bars.

If the height exceeds 40 cm, adapt the speed of the vehicle to the profile of the road to avoid damaging the roof bars and the fixings on the vehicle.

Be sure to refer to national legislation in order to comply with the regulations for transporting objects that are longer than the vehicle.

! **Recommendations**
Distribute the load uniformly, taking care to avoid overloading one of the sides. Arrange the heaviest part of the load as close as possible to the roof. Secure the load firmly.

Drive gently: the vehicle will be more susceptible to the effects of side winds and its stability may be affected.
Regularly check the security and tight fastening of the roof bars, at least before each trip.
Remove the roof bars once they are no longer needed.

! Sunroof

Check that the load does not pass below the roof bars so that it does not impede the movements of the sunroof - risk of major damage!

Direct fitting on roof

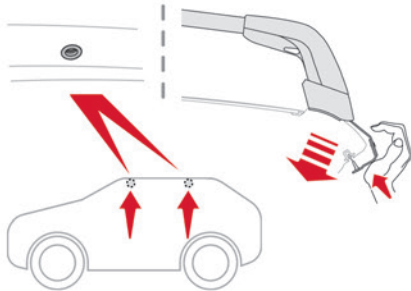

The transverse bars must only be fixed at the four anchorage points located on the roof frame. These points are concealed by the vehicle doors when the doors are closed.

The roof bar fixings have a stud which must be inserted into the opening of each anchorage point.

Snow chains

In wintry conditions, snow chains improve traction as well as the behaviour of the vehicle when braking.

! Snow chains must be fitted only to the front wheels. They must never be fitted to "space-saver" type spare wheels.

i Observe the legislation in force in your country relating to the use of snow chains and maximum authorised speeds.

Use only chains designed to be fitted to the type of wheel fitted to the vehicle:

Original tyre size	Chain type
215/65 R16	Polaire XP9 120 (9 mm)
215/60 R17	Polaire XP9 120 (9 mm)
195/60 R18	Polaire PSS 112 (10 mm)

For more information on snow chains, contact a dealer or a qualified workshop.

Installation tips

- ▶ To fit the snow chains during a journey, stop the vehicle on a flat surface at the side of the road.
- ▶ Apply the parking brake and position any wheel chocks under the wheels to prevent movement of the vehicle.
- ▶ Fit the snow chains following the instructions provided by the manufacturer.
- ▶ Move off gently and drive for a few moments, without exceeding 31 mph (50 km/h).
- ▶ Stop the vehicle and check that the snow chains are correctly tightened.

i It is strongly recommended that you practise fitting the snow chains on a level and dry surface before setting off.

! Avoid driving with snow chains on roads that have been cleared of snow to avoid damaging the vehicle's tyres and the road surface. If the vehicle is fitted with alloy wheels, check that no part of the chain or its fixings is in contact with the wheel rim.

Energy economy mode

This system manages the duration of use of certain functions, in order to conserve a sufficient level of charge in the battery with the ignition off. After switching off the engine and for a maximum cumulative period of around 30 minutes, you can

continue to use functions such as the audio and telematics system, dipped beam headlamps or courtesy lamps.

Selecting the mode

A confirmation message is displayed when energy economy mode is entered, and the active functions are placed on standby.

- ! If a telephone call is in progress at the time, it will be maintained for around 10 minutes via the audio system's hands-free system.

Exiting the mode

These functions are automatically reactivated the next time the vehicle is used.

To restore the use of these functions immediately, start the engine and let it run:

- For less than 10 minutes, to use the equipment for approximately 5 minutes.
- For more than 10 minutes, to use the equipment for approximately 30 minutes.

Let the engine run for the specified duration to ensure that the battery charge is sufficient.

To recharge the battery, avoid repeatedly or continuously restarting the engine.

- ! A flat battery prevents the engine from starting.

For more information on the **12 V battery/ Accessories battery/**, refer to the corresponding section.

Load reduction mode

This system manages the use of certain functions according to the level of charge remaining in the battery.

When the vehicle is being driven, the load reduction function temporarily deactivates certain functions, such as the air conditioning and the heated rear screen.

The deactivated functions are reactivated automatically as soon as conditions permit.

Bonnet

! Stop & Start

Before doing anything under the bonnet, you must switch off the ignition to avoid any risk of injury resulting from an automatic change to START mode.



! Electric motor

Take care with objects or clothing that could be caught in the blades of the cooling fan or in certain moving components - risk of strangulation and serious injury! Before carrying out any work under the bonnet, you must switch off the ignition, check that the **READY** indicator lamp is off on the

instrument panel and disconnect the charging nozzle if it is plugged in.



- ! The location of the interior bonnet release lever prevents the bonnet being opened when the left-hand front door is closed.

- ! When the engine is hot, handle the exterior safety catch and the bonnet stay with care (risk of burns), using the protected area. When the bonnet is open, take care not to damage the safety catch. Do not open the bonnet under very windy conditions.

- ! **Cooling of the engine when stopped**
The engine cooling fan may start after the engine has been switched off. **Take care with objects or clothing that could be caught in the blades of the fan!**

Opening

- ▶ Open the left-hand front door.

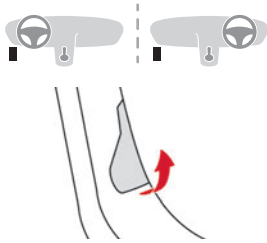

- ▶ Pull the interior release lever, located at the bottom of the door frame, towards you.

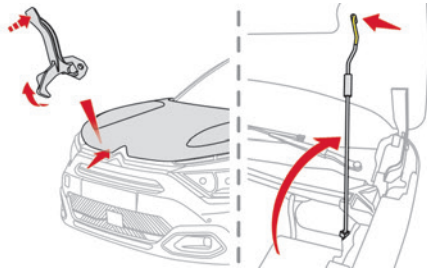

- ▶ Lift the exterior safety catch and raise the bonnet.
- ▶ Unclip the stay from its housing and place it in the support slot to hold the bonnet open.

Closing

- ▶ Hold the bonnet and pull out the stay from the support slot.
- ▶ Clip the stay in its housing.

- ▶ Lower the bonnet and release it near the end of its travel.
- ▶ Pull on the bonnet to check that it is locked correctly.

! Because of the presence of electrical equipment under the bonnet, it is strongly recommended that exposure to water (rain, washing, etc.) be limited.

Engine compartment

The engine shown here is an example for illustrative purposes only.

The locations of the following elements may vary:

- Air filter.
- Engine oil dipstick.
- Engine oil filler cap.

Petrol engine

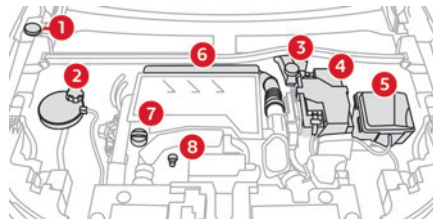

Diesel engine

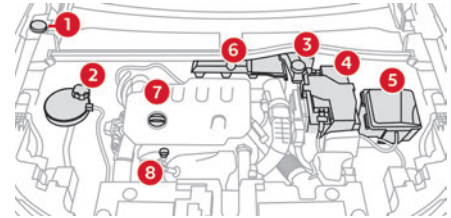

1. Screenwash fluid reservoir
2. Engine coolant reservoir
3. Brake fluid reservoir
4. Battery/Fuses
5. Fusebox
6. Air filter
7. Engine oil filler cap
8. Engine oil dipstick

! Diesel fuel system

This system is under very high pressure. All work must be carried out only by a CITROËN dealer or a qualified workshop

Electric motor

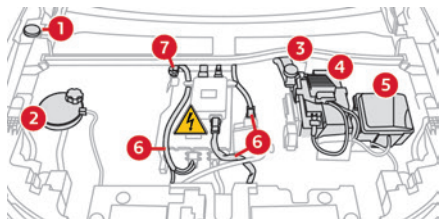

1. Screenwash fluid reservoir
2. Engine coolant reservoir (level only)
3. Brake fluid reservoir
4. Battery/Fuses
5. Fusebox
6. 400 V electrical circuit
7. Emergency circuit-breaker for emergency services and maintenance technicians

For more information on the **Charging system (Electric)**, refer to the corresponding section.

Checking levels

Check all of the following levels regularly in accordance with the manufacturer's service schedule. Top them up if required, unless otherwise indicated.

If a level drops significantly, have the corresponding system checked by a CITROËN dealer or a qualified workshop.

! The fluids must comply with the manufacturer's requirements and with the vehicle's engine.

! Take care when working under the bonnet, as certain areas of the engine may be extremely hot (risk of burns) and the cooling fan could start at any time (even with the ignition off).

Used products

! Avoid prolonged contact of used oil or fluids with the skin.

Most of these fluids are harmful to health and very corrosive.



Do not discard used oil or fluids into sewers or onto the ground.

Empty used oil into the containers reserved for this purpose at a CITROËN dealer or a qualified workshop.

Engine oil



The level is checked, with the engine having been switched off for at least 30 minutes and on level ground, either using the oil level indicator in the instrument panel when the ignition is switched on (for vehicles equipped with an electric gauge), or using the dipstick.

It is normal to top up the oil level between two services (or oil changes). It is recommended that you check the level, and top up if necessary, every 3,000 miles (5,000 km).

! In order to maintain the reliability of the engine and emissions control system, never use additives in the engine oil.

Checking using the dipstick

For the location of the dipstick, please refer to the illustration of the corresponding engine compartment.

► Grasp the dipstick by its coloured grip and pull it out completely.

► Wipe the end of the dipstick using a clean, lint-free cloth.

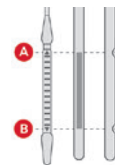

► Reinsert the dipstick and push fully down, then pull it out again to visually check the oil level: the correct level is between marks **A** (max) and **B** (min).

Do not start the engine if the level is:

– above mark **A**: contact a CITROËN dealer or a qualified workshop.

– below mark **B**: top up the engine oil immediately.

! Oil grade

Before topping up or changing the engine oil, check that the oil is suitable for your engine and complies with the recommendations in the service schedule supplied with the vehicle (or available from your CITROËN dealer or qualified workshop). Use of non-recommended oil may invalidate your warranty in the event of engine failure.

Topping up the engine oil level

For the location of the engine oil filler cap, please refer to the corresponding engine compartment illustration.

- ▶ Add oil in small quantities, avoiding any spills on engine components (risk of fire).
- ▶ Wait a few minutes before checking the level again using the dipstick.
- ▶ Top up the level if necessary.
- ▶ After checking the level, carefully screw the oil filler cap back on and replace the dipstick in its tube.

i The oil level indication displayed on the instrument panel when the ignition is switched on is not valid for 30 minutes following an addition of oil.

Brake fluid

The level of this fluid should be close to the **"MAX"** mark. If not, check the brake pads for wear.

To know how often the brake fluid should be replaced, refer to the manufacturer's servicing schedule.

! Clean the cap before removing it to refill. Use only DOT4 brake fluid from a sealed container.

Engine coolant**(Petrol or Diesel)**

It is normal to top up this fluid between two services.

The check and top-up must only be done with the engine cold.

A level of coolant that is too low risks causing major damage to the engine; the coolant level must be close to the **"MAX"** mark without ever going above it.

If the level is close to or below the **"MIN"** mark, it is essential to top it up.

When the engine is hot, the temperature of the coolant is regulated by the fan.

As the cooling system is pressurised, wait at least one hour after switching off the engine before carrying out any work.

In order to avoid the risk of scalding if you need to top up in an emergency, wrap a cloth around the cap and unscrew the cap by two turns to allow the pressure to drop.

Once the pressure has dropped, remove the cap and top up to the required level.

(Electric)

Do not top up the coolant.

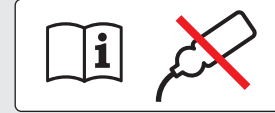

If the level is close to or below the **"MIN"** mark, it is essential to contact a CITROËN dealer or a qualified workshop.

Screenwash fluid

Top up to the required level when necessary.

Fluid specification

The fluid must be topped up with a pre-mixed product.

In winter (temperatures below zero), a fluid containing an anti-freeze agent which is appropriate for the temperature conditions must be used in order to protect the system's components (pump, tank, ducts, jets).



Filling with pure water is prohibited in all circumstances (risk of freezing, limescale, etc.).

AdBlue® (BlueHDi)

An alert is triggered when the reserve level is reached.

For more information on the **Indicators** and in particular the AdBlue range indicators, refer to the corresponding section.

To avoid the vehicle being immobilised in accordance with regulations, you must top up the AdBlue tank.

For more information on **AdBlue® (BlueHDi)**, and in particular the supply of AdBlue, refer to the corresponding section.

Checks

Unless otherwise indicated, check these components in accordance with the manufacturer's service schedule and according to your engine.

Otherwise, have them checked by a CITROËN dealer or a qualified workshop.

! Only use products recommended by CITROËN or products of equivalent quality and specification.

In order to optimise the operation of components as important as those in the braking system, CITROËN selects and offers very specific products.

12 V battery



The battery does not require any maintenance.

Check regularly that the terminals are correctly tightened (versions without quick-release terminals) and that the connections are clean.

i For more information on the precautions to take before any work on the **12 V battery**, refer to the corresponding section.

! Versions equipped with Stop & Start are fitted with a 12 V lead-acid battery of specific technology and specification. Its replacement should be carried out only by a CITROËN dealer or a qualified workshop.

Passenger compartment filter



Depending on the environment and the use of the vehicle (e.g. dusty atmosphere, city driving), **change it twice as often, if necessary**.

i A clogged passenger compartment filter can adversely affect air conditioning system performance and generate undesirable odours.

Air filter



Depending on the environment and the use of the vehicle (e.g. dusty atmosphere, city driving), **change it twice as often, if necessary**.

Oil filter



Change the oil filter each time the engine oil is changed.

Particle filter (Diesel)



The start of clogging of the particle filter is indicated by the temporary lighting of this warning lamp, accompanied by an alert message.

As soon as the traffic conditions permit, regenerate the filter by driving at a speed of at least 37 mph (60 km/h) until the warning lamp goes off.

i Following prolonged operation of the vehicle at very low speed or at idle, you may, in exceptional circumstances, notice water vapour coming from the exhaust while accelerating. These emissions have no impact on the vehicle's behaviour and the environment.

i **New vehicle**
During the first few particle filter regeneration operations, you may notice a "burning" smell. This is perfectly normal.

Manual gearbox



The gearbox does not require any maintenance (no oil change).

Automatic gearbox



The gearbox does not require any maintenance (no oil change).

Manual parking brake



If you notice excessive brake lever travel or decreased effectiveness, the parking brake must be adjusted, even between two services.

This system must be checked by a CITROËN dealer or a qualified workshop.

Electric parking brake



This system does not require any routine servicing. However, in the event of a problem, do not hesitate to have the system checked by a CITROËN dealer or a qualified workshop.

i For more information on the **Electric parking brake**, refer to the corresponding section.

Brake pads



Brake wear depends on the style of driving, particularly in the case of vehicles used in town, over short distances. It may be

necessary to have the condition of the brakes checked, even between vehicle services. Unless there is a leak in the circuit, a drop in the brake fluid level indicates that the brake pads are worn.

i After washing the vehicle, moisture, or in wintry conditions, ice can form on the brake discs and pads: braking efficiency may be reduced. Gently dab the brakes to dry and defrost them.

Brake disc/drum wear



For any information on checking brake disc/drum wear, contact a CITROËN dealer or a qualified workshop.

Wheels and tyres



The inflation pressure of all tyres, including the spare wheel, must be checked on "cold" tyres. The pressures indicated on the tyre pressure label are valid for "cold" tyres. If you have driven for more than 10 minutes or more than 6 miles (10 kilometres) at over 31 mph (50 km/h), add 0.3 bar (30 kPa) to the values indicated on the label.

! Under-inflation increases energy consumption. Non-compliant tyre pressures cause tyres to wear prematurely and have an adverse effect on the vehicle's road holding - risk of accident!

Driving with worn or damaged tyres reduces the braking and road holding performance of the vehicle. Regularly check the condition of the tyres (tread and sidewalls) and rims as well as the presence of the valve caps.

When the wear indicators no longer appear set back from the tread, the depth of the grooves is less than 1.6 mm; replace the tyres as soon as possible.

Using different size wheels and tyres from those specified can affect the lifetime of tyres, wheel rotation, ground clearance, the speedometer reading and have an adverse effect on road holding.

Fitting different size tyres on the front and rear axles can cause the ESC to mistime.

Always mark the direction of rotation on the tyres that will be stored when fitting winter or summer tyres. Store them in a cool, dry place and away from direct exposure to the sun's rays.



Winter or 4-seasons tyres can be identified by this symbol on their sidewalls.

Shock absorbers



It is not easy for drivers to detect when shock absorbers are worn. Nevertheless, the shock absorbers have a major impact on road holding and braking performance. For your safety and driving comfort, it is important to have them regularly checked by a CITROËN dealer or a qualified workshop.

Timing and accessory kits



The timing and accessory kits are used from the time the engine is started until it is switched off. It is normal for them to wear over time.

A faulty timing or accessory kit can damage the engine, rendering it unusable. Observe the recommended replacement frequency, stated in distance travelled or time elapsed, whichever is reached first.

AdBlue® (BlueHDi)

To respect the environment and ensure compliance with the Euro 6 standard, without adversely affecting the performance or fuel consumption of its Diesel engines, CITROËN has taken the decision to equip its vehicles with a system that combines SCR (Selective Catalytic Reduction) with a Diesel Particle Filter (DPF) for the treatment of exhaust gases.

SCR system

Using a liquid called AdBlue® that contains urea, a catalytic converter turns up to 85% of the nitrogen oxides (NOx) into nitrogen and water, which are harmless to health and the environment.



The AdBlue® is contained in a **special tank** holding about 15 litres. Its capacity allows a driving range of approximately 4,000 miles (6,500 km), **which**

may vary considerably depending on your driving style.

An alert system is triggered once the reserve level is reached: it is then possible to drive for a further 1,500 miles (2,400 km) before the tank is empty and the vehicle is immobilised.

i For more information on the **Warning and indicator lamps** and the associated alerts, or the **Indicators**, please refer to the corresponding sections.

! Once the AdBlue® tank is empty, a device required by law prevents the engine from being restarted.

If the SCR system is faulty, the level of emissions from the vehicle will no longer meet the Euro 6 standard and the vehicle starts polluting the environment.

In the event of a confirmed SCR system malfunction, it is essential to visit a CITROËN dealer or a qualified workshop. After 685 miles (1,100 km), a device is automatically activated to prevent the engine from starting. In both cases, a range indicator indicates the distance that can be travelled before the vehicle is stopped.

i **Freezing of the AdBlue®**
AdBlue® freezes at temperatures below around -11°C.

The SCR system includes a heater for the AdBlue® tank, allowing you to continue driving in very cold conditions.

Supply of AdBlue®

It is recommended that the AdBlue® be topped up as soon as the first alert is issued indicating that the reserve level has been reached.

- !** For the correct operation of the SCR system:
- Use only AdBlue® fluid that meets the ISO 22241 standard.
 - Never transfer AdBlue® to another container as it would lose its purity.
 - Never dilute AdBlue® with water.

You can obtain AdBlue® from a CITROËN dealer or a qualified workshop, as well as service stations equipped with AdBlue® pumps specially designed for passenger vehicles.

Recommendations on storage

AdBlue® freezes at about -11°C and deteriorates above +25°C. Containers should be stored in a cool area and protected from direct sunlight. Under these conditions, the fluid can be kept for at least a year.

If the fluid has frozen, it can be used once it has completely thawed out at room temperature.

- !** Never store AdBlue® containers in your vehicle.

Precautions for use

AdBlue® is a urea-based solution. This fluid is non-flammable, colourless and odourless (when kept in a cool place).

In the event of contact with the skin, wash the affected area with soap and running water. In the event of contact with the eyes, immediately rinse the eyes with large amounts of water or with an eye wash solution for at least 15 minutes. Seek medical attention if you feel a persistent burning sensation or irritation.

If swallowed, immediately wash out the mouth with clean water and then drink plenty of water. In certain conditions (high temperature, for example), the risk of release of ammonia cannot be excluded: do not inhale the fluid. Ammonia vapours have an irritant effect on mucous membranes (eyes, nose and throat).

- ! Store AdBlue® out of the reach of children, in its original container.

Procedure

Before starting the top-up procedure, ensure that the vehicle is parked on a flat and level surface. In wintry conditions, ensure that the temperature of the vehicle is above -11°C. Otherwise the AdBlue® may be frozen and so cannot be poured into the tank. Park the vehicle in a warmer area for a few hours to allow the top-up to be carried out.

- ! Never pour the AdBlue® into the Diesel fuel tank.

- ! If any AdBlue® is splashed, or if there are any spillages on the bodywork, rinse immediately with cold water or wipe with a damp cloth.
If the fluid has crystallised, clean it off using a sponge and hot water.

- ! Important: **in the event of a top-up after a breakdown because of a lack of AdBlue**, it is essential to wait around 5 minutes before switching on the ignition, **without opening the driver's door, unlocking the vehicle, inserting the key into the ignition switch, or bringing the key to the "Keyless Entry and Start" system into the passenger compartment.** Switch on the ignition, then wait for 10 seconds before starting the engine.

- ▶ Switch off the ignition and remove the key from the switch to switch off the engine.
or
- ▶ With Keyless Entry and Start, press the **"START/STOP"** button to switch off the engine.

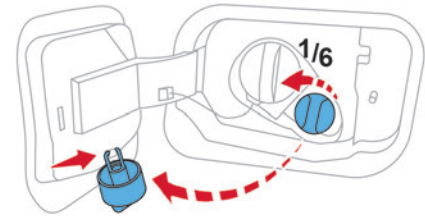

- ▶ Turn the blue cap of the AdBlue® tank anti-clockwise and remove it.
- ▶ With a container of AdBlue®: after checking the expiry date, read the instructions on the label carefully before pouring the contents of the container into the vehicle's AdBlue tank.
- ▶ With an AdBlue® pump: insert the nozzle and fill the tank until the nozzle automatically cuts out.

- ! In order not to overfill the AdBlue® tank:
 - Add between 10 and 13 litres using AdBlue® containers.
 - Stop after the nozzle's first automatic cut-out, if you are refilling at a service station. The system only registers AdBlue® top-ups of 5 litres or more.

- ! If the AdBlue® tank is completely empty
 - which is confirmed by the message "Top up AdBlue: Starting impossible" – it is essential to add at least 5 litres.

Changing to free-wheeling

In certain situations, it is necessary to put the vehicle into free-wheeling mode (e.g. towing, on a rolling road, automatic car wash (Wash mode), rail or sea transport).

The procedure varies according to the type of gearbox and parking brake.

! Never leave the vehicle unattended with the vehicle into free-wheeling mode.

i Keyless Entry and Start

You must not depress the brake pedal while switching the ignition on again, then switching it off. If you do, the engine will start, requiring you to restart the procedure.



Release procedure

► With the vehicle stationary and the engine running, depress the brake pedal and select mode **N**.

Within 5 seconds:

- Depress and hold the brake pedal, then observe this order: switch off the engine and move the push selector forwards or backwards.
- Release the brake pedal, then switch on the ignition.
- Place your foot on the brake and press the electric parking brake control to release it.

► Release the brake pedal, then switch off the ignition.

! A message is displayed on the instrument panel to confirm the unlocking of the wheels for 15 minutes.

After 15 minutes or reverting to normal operation

► While depressing the brake pedal, restart the engine and select mode **P**.

Advice on care and maintenance

General recommendations

Observe the following recommendations to avoid damaging the vehicle.

Exterior

! Never use a high-pressure jet wash in the engine compartment - risk of damaging the electrical components!
Do not wash the vehicle in bright sunshine or extremely cold conditions.

i When washing the vehicle in an automatic roller-brush car wash, be sure

to lock the doors and, depending on version, move the electronic key away.

When using a pressure washer, keep the jet nozzle at a minimum distance of 30 cm from the vehicle (particularly when cleaning areas containing chipped paint, sensors or seals). Promptly clean up any stains containing chemicals liable to damage the vehicle's paintwork (including tree resin, bird droppings, insect secretions, pollen and tar). Depending on the environment, clean the vehicle frequently to remove salty deposits (in coastal areas), soot (in industrial areas) and mud/salts (in wet or cold areas). These substances can be highly corrosive.

Contact a CITROËN dealer or a qualified workshop for advice on removing stubborn stains requiring special products (such as tar or insect removers).

Preferably, have paint touch-ups performed by a CITROËN dealer or a qualified workshop.

Interior

! When washing the vehicle, never use a water hose or high-pressure jet to clean the interior.

Liquids carried in cups or other open containers can spill, presenting a risk of damage to the instruments and controls and the controls located on the centre console. Be vigilant!

To clean instrument panels, touch screens or other displays, wipe gently with a soft, dry cloth. Do not use products (e.g. alcohol, disinfectant) or soapy water directly on these surfaces - risk of damage!

Bodywork

High-gloss paint

! Do not use abrasive products, solvents, petrol or oil to clean the bodywork.

Never use an abrasive sponge to clean stubborn stains - risk of scratching the paintwork!

Do not apply polish in strong sunshine, or to plastic or rubber parts.

i Use a soft cloth and soapy water or a pH neutral product.

Gently wipe the bodywork with a clean microfibre cloth.

Apply polish with the vehicle clean and dry. Comply with the instructions for use stated on the product.

Decals

(Depending on version)

! Do not use a high-pressure washer to clean the vehicle - risk of damaging or detaching the decals!

i Use a high-flow hose (temperature between 25°C and 40°C).

Place the jet of water perpendicular to the surface to be cleaned.

Rinse the vehicle with demineralised water.

Textile

The dashboard, door panels and seats may contain parts made of textile material.

Maintenance

! Do not use aggressive cleaning products (e.g. alcohol, solvent or ammonia).

Do not use steam-cleaning systems - risk of affecting the adhesion of the fabrics!

i Remove dust from the textile parts regularly with a dry cloth, soft brush or vacuum cleaner.

Rub down the textile parts once per year with a clean, damp cloth. After leaving overnight to dry, brush with a soft-bristled brush.

Stain removal

! Do not rub the stain or it may spread or you may cause the substance to penetrate the surface.

i Act quickly by reducing the stain from its edges inwards.

Remove as much substance or solids as possible using a spoon or spatula, and remove as much liquid as possible using absorbent paper.

i **Product/Procedure to use depending on the type of stain:**

- Grease, oil and ink: clean with a pH-neutral detergent.
 - Vomit: clean with sparkling mineral water.
 - Blood: spread flour over the stain and allow to dry; remove with a slightly damp cloth.
 - Mud: allow to dry and then remove with a slightly damp cloth.
 - Cake, chocolate, ice cream: clean with lukewarm water.
 - Sugary and/or alcoholic drinks: clean with lukewarm water, or lemon juice if the stain is persistent.
 - Hair gel, coffee, tomato sauce, vinegar: clean with lukewarm water and lemon juice.
- For solid substances, then use a soft brush or vacuum cleaner.
- For liquid substances, then use a damp microfibre cloth and then dry with another cloth.

Leather

Leather is a natural product. Appropriate regular care is essential for its durability.

It must be protected and nourished using a specific leather product, to keep it supple and preserve its original appearance.

! Do not clean leather using unsuitable cleaning agents such as solvents, detergents, petrol or pure alcohol.

When cleaning items partly made from leather, take care not to damage the other materials with the specific leather product.

i Before cleaning greasy stains or liquids, quickly mop up any surplus.

Before cleaning, wipe off any residues liable to scuff the leather, using a cloth that has been dampened with demineralised water and thoroughly wrung out.

Clean leather using a soft cloth moistened with soapy water or a pH-neutral product. Dry with a soft, dry cloth.

Warning triangle

This reflective and dismantlable device is to be installed on the side of the road when a vehicle is broken down or damaged.

! Before getting out of the vehicle

Turn on the hazard warning lamps, then put on the safety vest to assemble and install the triangle.

Storage

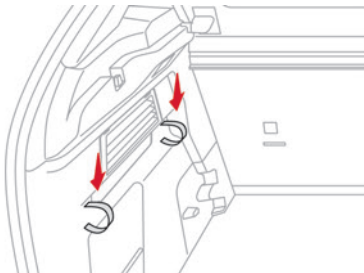

Use the straps on the boot side trim to stow the folded triangle or its storage box.

Assembling and placing the triangle

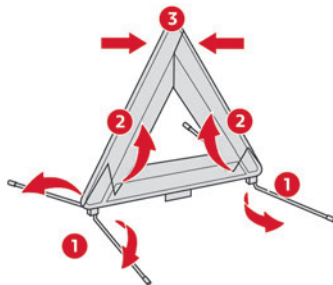

For versions supplied with a triangle as original equipment, refer to the illustration above. For other versions, refer to the assembly instructions provided with the triangle.

► Put the triangle in place behind the vehicle, as required by local legislation.

Running out of fuel (Diesel)

With Diesel engines, the fuel system must be primed if you run out of fuel.

Before starting to prime the system, it is essential to put at least 5 litres of Diesel into the fuel tank.

i For more information on **Refuelling** and on **Misfuel prevention (Diesel)**, refer to the corresponding section.

1.5 BlueHDi engines

- Switch on the ignition (without starting the engine).
- Wait around 1 minute and switch off the ignition.
- Operate the starter motor to start the engine. If the engine does not start at the first attempt, do not keep trying, but restart the procedure.

Tool kit

Set of tools supplied with the vehicle.

Its content depends on your vehicle's equipment:

- Temporary puncture repair kit.
- Spare wheel.

Access to the tools

Depending on version, the tool kit is stored in a bag or in a storage box in the boot.

! These tools are specific to the vehicle and may vary according to the level of equipment. Do not use them for any other purpose.

! The jack must only be used to change a wheel with a damaged or punctured tyre. Do not use any jack other than the one supplied with the vehicle. If the vehicle does not have its original jack, contact a CITROËN dealer or a qualified workshop to obtain the one that was intended by the manufacturer.

The jack meets European standards, as defined in the Machinery Directive 2006/42/CE.
The jack does not require any maintenance.

List of tools

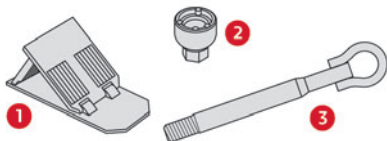

1. Chock to immobilise the vehicle (depending on equipment)
2. Socket for the wheel security bolts (located in the glove box) (depending on equipment)
To adapt the wheelbrace to the special 'security' bolts.
3. Removable towing eye

For more information on **Towing the vehicle** and using the removable towing eye, refer to the corresponding section.

With temporary puncture repair kit

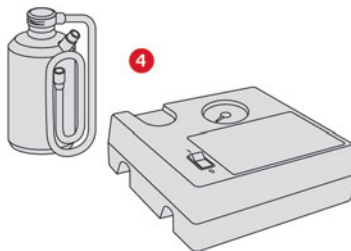

4. 12 V compressor with cartridge of sealant and speed limit sticker
For temporary repair of a tyre and to adjust the tyre pressure.

For more information about the **Temporary puncture repair kit**, refer to the corresponding section.

With spare wheel

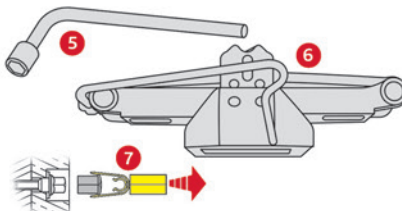

5. Wheelbrace
For removing the wheel bolts.

6. Jack with integrated handle
To raise the vehicle.
7. Wheel bolt cap removal tool (depending on equipment)
For removing the wheel bolt head finishers on alloy wheels.

For more information on the **Spare wheel**, refer to the corresponding section.

Temporary puncture repair kit

Scan the QR Code on page 3 to view explanatory videos.

Made up of a compressor and a sealant cartridge, it allows you to carry out a **temporary repair** of the tyre so that you can drive to the nearest garage.

It is designed to repair most punctures located on the tyre tread.

The vehicle's electric system allows the connection of the compressor to the 12 V power supply for long enough to repair a tyre after a puncture.

For more information on the **Tool kit**, refer to the corresponding section.

i Tyre inflation pressures are indicated on this label.

For more information on **Identification markings**, particularly this label, refer to the corresponding section.

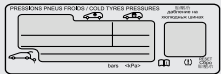

! Should the pressure of one or more tyres be adjusted, it is necessary to reinitialise the under-inflation detection system. For more information on **Tyre under-inflation detection**, refer to the corresponding section.

Repair procedure

! Do not remove any foreign body (e.g. nail, screw) which has penetrated the tyre.

- ▶ Park the vehicle without obstructing traffic and apply the parking brake.
- ▶ Follow the safety instructions (hazard warning lamps, warning triangle, high visibility jacket, etc.) according to the legislation in force in the country in which you are driving.
- ▶ Switch the ignition off.
- ▶ Uncoil the pipe stowed under the compressor.

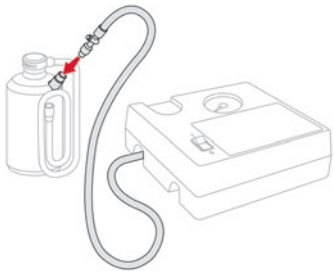

▶ Connect the pipe from the compressor to the bottle of sealant.

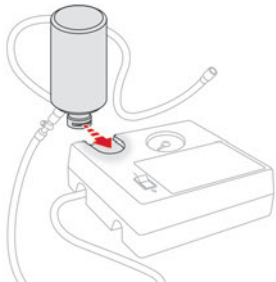

- ▶ Turn the bottle of sealant over and secure it in the notch provided on the compressor.
- ▶ Remove the valve cap from the tyre to be repaired, and place it in a clean place.

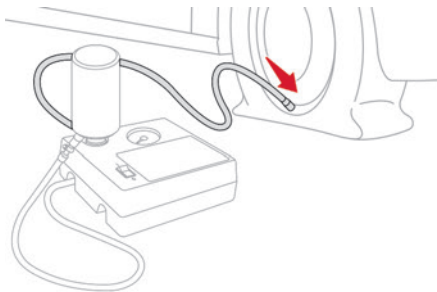

- ▶ Connect the hose from the bottle of sealant to the valve of the tyre to be repaired and tighten firmly.
- ▶ Check that the compressor switch is in position "O".
- ▶ Fully uncoil the electric cable stowed under the compressor.
- ▶ Connect the compressor's electric plug to the vehicle's 12 V socket.



▶ Affix the speed limit sticker.

! The speed limit sticker must be affixed inside the vehicle in the area close to the driver, to remind them that a wheel is in temporary use.

▶ Switch the ignition on.

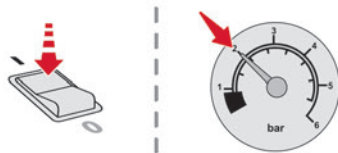

- ▶ Switch on the compressor by moving the switch to position "I" until the tyre pressure reaches 2 bar. The sealant product is injected under pressure into the tyre; do not disconnect the pipe from the valve during this operation (risk of blowback).

! If after approximately 7 minutes, the pressure of 2 bar is not reached, this indicates that the tyre is not repairable; contact a CITROËN dealer or a qualified workshop for assistance.

- ▶ Move the switch to position "O".
- ▶ Disconnect the compressor's electric plug from the vehicle's 12 V socket.
- ▶ Remove the kit.
- ▶ Refit the cap on the valve.
- ▶ Remove and store the bottle of sealant.

! The sealant product is harmful if swallowed and causes irritation to the eyes. Keep this product out of the reach of children. The use-by date of the fluid is marked on the bottle.

After use, do not discard the bottle into the environment; take it to a CITROËN dealer or an authorised waste disposal site. Do not forget to obtain a new bottle of sealant, available from a CITROËN dealer or a qualified workshop.

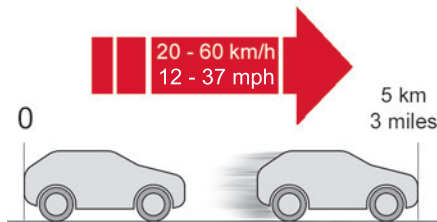

- ▶ Drive immediately for approximately 3 miles (5 kilometres) at reduced speed (between 12 and 37 mph (20 and 60 km/h)) to plug the puncture.
- ▶ Stop to check the repair **and the tyre pressure** using the kit.

! With a tyre repaired using this type of kit, do not exceed a speed of 50 mph (80 km/h) and do not drive more than 50 miles (80 km). You must contact a CITROËN dealer or a qualified workshop to have the repair checked and the tyre changed.

Checking/adjusting tyre pressures

The compressor can be used, **without injecting sealant**, to check and, if necessary, adjust the tyre pressures.

- ▶ Remove the valve cap from the tyre and keep it in a clean place.
- ▶ Uncoil the pipe stowed under the compressor.
- ▶ Screw the pipe onto the valve and tighten firmly.
- ▶ Check that the compressor switch is in position "O".
- ▶ Fully uncoil the electric cable stowed under the compressor.
- ▶ Connect the compressor's electric plug to the vehicle's 12 V socket.
- ▶ Switch the ignition on.
- ▶ Start the compressor by placing the switch at position "I" and adjust the pressure to the value shown on the vehicle's tyre pressure label. To deflate: press the black button located on the compressor pipe, near the valve connection.

! If after 7 minutes the pressure of 2 bar is not reached, the tyre is damaged; contact a CITROËN dealer or a qualified workshop for assistance.

- ▶ Once the correct pressure is reached, put the switch in position "O".
- ▶ Remove the kit and stow it.
- ▶ Refit the cap on the valve.

Spare wheel

i Scan the QR Code on page 3 to view explanatory videos.

i For more information on the **Tool kit**, refer to the corresponding section.

Accessing the spare wheel

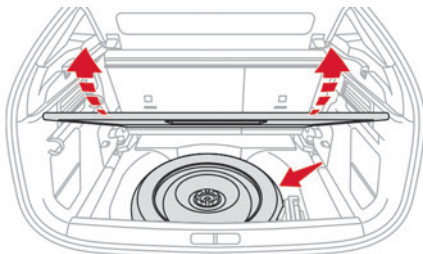

The spare wheel is stored in the boot, under the floor.

To access the spare wheel, first refer to the **Tool kit** section.

i Depending on version, the spare wheel may be a standard (steel or aluminium) or 'space-saver' wheel.

Removing the spare wheel

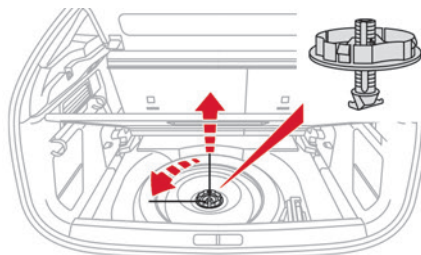

- ▶ Slacken the central nut.
- ▶ Remove the fastening device (nut and bolt).
- ▶ Lift the spare wheel towards you from the rear.
- ▶ Take the wheel out of the boot.

Putting the spare wheel back in place

! The punctured wheel cannot be put under the boot floor.

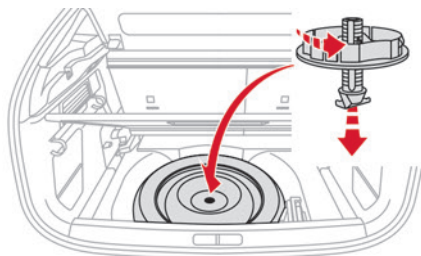

- ▶ Put the spare wheel back in place in its housing.
- ▶ Slacken the nut on the bolt by a few turns.
- ▶ Position the fastening device (nut and bolt) in the middle of the wheel.
- ▶ Tighten the central nut sufficiently to retain the wheel correctly.
- ▶ Depending on version, put the tool box back in place in the middle of the wheel and clip it in place.

Removing a wheel

! Parking the vehicle

Immobilise the vehicle where it does not obstruct traffic: the ground must be level, stable and non-slippery.

With a manual gearbox, engage first gear to lock the wheels, apply the parking brake, unless it is set to automatic mode, and switch off the ignition.

With an automatic gearbox, select mode **P** to lock the wheels, apply the parking brake, unless it is set to automatic mode, and switch off the ignition.

Check that the parking brake indicator lamps on the instrument panel are on.

The occupants must get out of the vehicle and wait where they are safe.

If necessary, place a chock under the wheel diagonally opposite the wheel to be changed. Never go underneath a vehicle raised using a jack; use an axle stand.

I Wheel with wheel trim

When removing the wheel, first remove the wheel trim by pulling at the valve aperture using the wheelbrace.

When refitting the wheel, refit the wheel trim, starting by placing its aperture in line with the valve and then pushing it into place all round its edge with the palm of your hand. Wheel trims are identified by a "LEFT" mark on the left-hand side and a "RIGHT" mark on the right-hand side. Do not reverse these when removing/refitting the wheel.

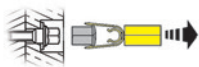
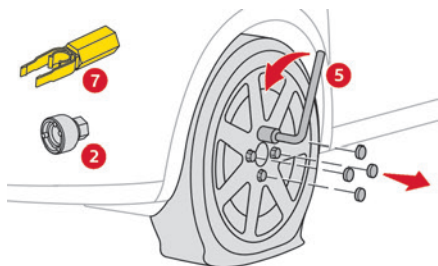

- ▶ To remove the wheel bolt cover on each of the bolts, use tool 7 (alloy wheels).
- ▶ Fit security socket 2 on wheelbrace 5 to slacken the security bolt.
- ▶ Slacken the other bolts using the wheelbrace 5 only.

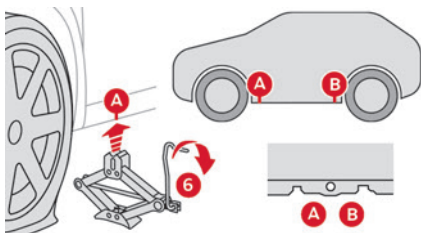

- ▶ Place the foot of jack 6 on the ground and ensure that it is directly below the front A or rear B jacking point on the underbody, whichever is closest to the wheel to be changed.

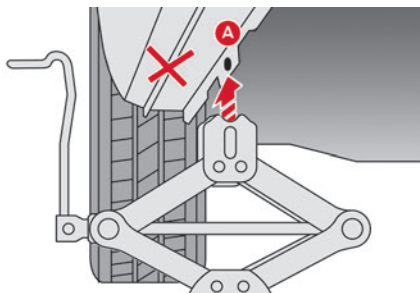

- ▶ Extend jack 6 until its head comes into contact with jacking point A or B; contact area A or B on the vehicle must be properly inserted into the central part of the head of the jack.
- ▶ Raise the vehicle until there is sufficient space between the wheel and the ground to easily admit the spare (not punctured) wheel.

! Ensure that the jack is stable. If the ground is slippery or loose, the jack may slip or collapse - risk of injury!
Take care to position the jack strictly at one of the jacking points A or B under the vehicle, ensuring that the head of the jack is centred under the contact area on the vehicle. Otherwise, there is a risk of damage to the vehicle and/or of the jack collapsing - risk of injury!

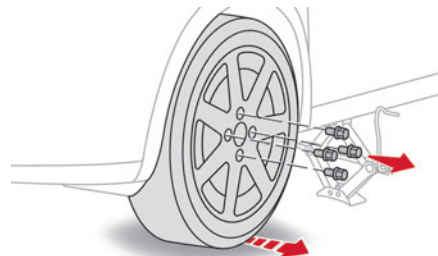

- ▶ Remove the bolts and store them in a clean place.
- ▶ Remove the wheel.

Fitting a wheel

- i** Fitting a steel or "space-saver" type spare wheel

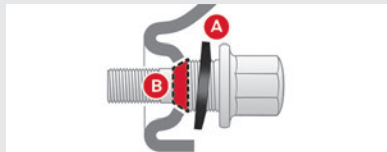

If the vehicle is fitted with alloy wheels, the washers **A** do not make contact with the steel or "space-saver" type spare wheel. The wheel is held in place by the conical contact surface **B** of each bolt.

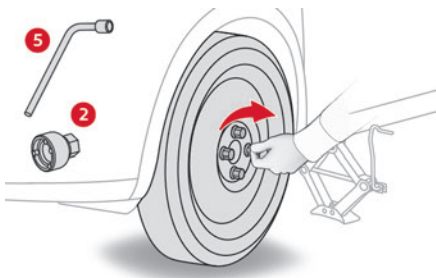

- ▶ Fit the wheel on the hub.
- ▶ Screw in the bolts by hand as far as possible.
- ▶ Pre-tighten the security bolt using the wheelbrace **5** equipped with a security socket **2**.
- ▶ Pre-tighten the other bolts using the wheelbrace **5** only.

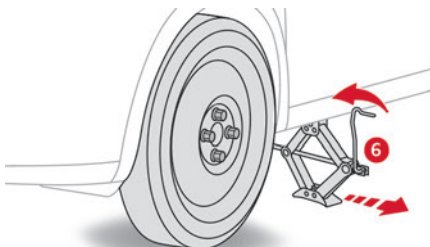

- ▶ Lower the vehicle again fully.
- ▶ Fold jack **6** and remove it.

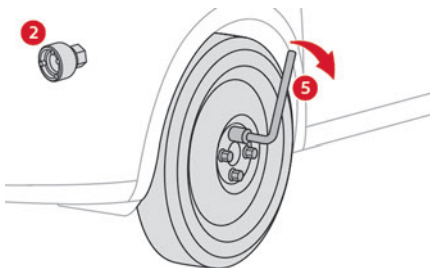

- ▶ Tighten the security bolt using the wheelbrace **5** equipped with a security socket **2**.
- ▶ Tighten the other bolts using the wheelbrace **5** only.
- ▶ Refit the bolt covers to each of the bolts (depending on equipment).
- ▶ Store the tools.

After changing a wheel

- !** With a "space-saver" type spare wheel



Deactivate certain driving aid functions (Active Safety Brake, Adaptive cruise control, etc.).

Do not exceed the maximum authorised speed of 50 mph (80 km/h).

Driving with more than one "space-saver" type spare wheel is prohibited.

- !** Visit a CITROËN dealer or a qualified workshop.

Have the tightening of the spare wheel's bolts and its tyre pressure checked.

Have the punctured tyre examined. After inspection, the technician will advise you on whether the tyre can be repaired or if it must be replaced.

Changing a bulb

- i** In some weather conditions (e.g. low temperature or humidity), misting on the internal surface of the glass of the headlamps and rear lamps is normal, and will disappear

after the lamps have been on for a few minutes.

! Never look too closely at the light beam of LED technology lamps - risk of serious eye injury!



! The headlamps have polycarbonate lenses with a protective coating:
– **Do not clean them with a dry or abrasive cloth, nor with detergent or solvent products.**

- Use a sponge and soapy water or a pH neutral product.
- When using a high-pressure washer on persistent marks, do not keep the lance directed towards the headlamps, lamps or their edges for too long, so as not to damage their protective coating and seals.

! Changing a bulb must only be done with the ignition off and after the headlamp /

lamp has been switched off for several minutes - risk of serious burns!
Do not touch the bulb directly with your fingers; use a lint-free cloth.
It is essential only to use anti-ultraviolet (UV) type bulbs, so as not to damage the headlamp.
Always replace a failed bulb with a new bulb of the same type and specification. To avoid lighting imbalance, replace the bulbs in pairs.

i Refitting the lamp units
Perform the operations in the reverse order to dismantling.

Light-emitting diode (LED) headlamps and lamps

Depending on version, the affected types of headlamps/lamps are:

- "LED" technology headlamps.
- Front foglamps.
- Daytime running lamps/sidelamps.
- Direction indicator side repeaters.
- Side spotlamps.
- Third brake lamp.
- Number plate lamps.

! If you need to replace this type of bulb, you must contact a CITROËN dealer or a qualified workshop.
Do not touch the LED technology bulbs - risk of electrocution!

Front lamps

Model with LED headlamps

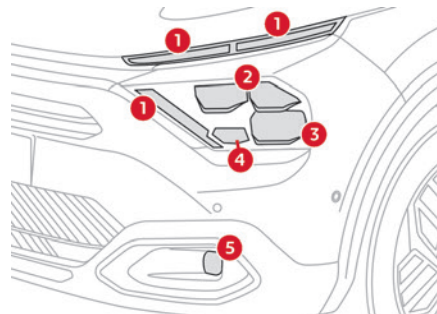

1. Daytime running lamps/Sidelamps
2. Dipped beam headlamps
3. Main beam headlamps
4. Direction indicators
5. Foglamps

Model with halogen headlamps

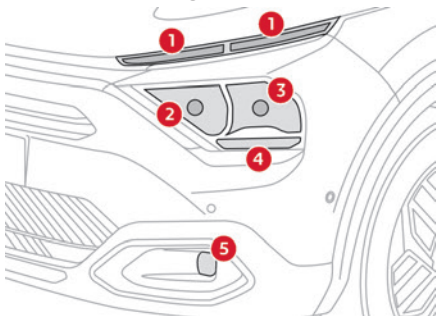

1. Daytime running lamps/Sidelamps (LED)
2. Main beam headlamps (H7)
3. Dipped beam headlamps (H7)
4. Direction indicators (PY21W)
5. Foglamps (LED)

! Opening the bonnet/Accessing the bulbs

Proceed with caution when the engine is hot - risk of burns!

Take care with objects or clothing that could be caught in the blades of the cooling fan - risk of strangulation!



i Halogen bulbs (Hx)

To ensure good quality lighting, check that the bulb is correctly positioned in its housing.

Main/Dipped beam headlamps

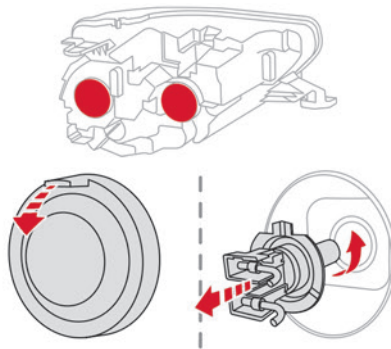

- ▶ Remove the protective cover by pulling on the tab.
 - ▶ Disconnect the bulb connector.
 - ▶ Remove the bulb and replace it.
- To refit, carry out these operations in reverse order, directing the bulb's positioning lug downwards.

Direction indicators

- i Rapid flashing of the indicator lamp for a direction indicator (left or right) indicates

that one of the bulbs on the corresponding side has failed.

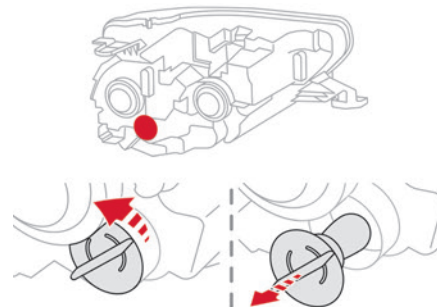

- ▶ Turn the connector a quarter turn anti-clockwise.
- ▶ Pull the bulb connector.
- ▶ Remove the bulb and replace it.

- i Amber-coloured bulbs must be replaced by bulbs with identical specifications and colour.

Rear lamps

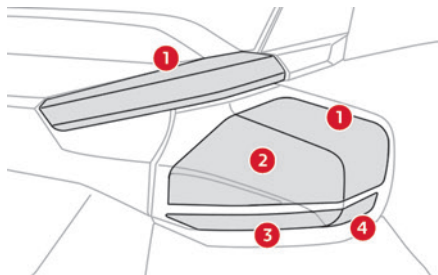

1. Sidelamps (LED)
2. Brake lamps (P21W)
3. Reversing lamps (W16W)
4. Direction indicators (WY16W)

Changing bulbs

The bulbs are changed from inside the boot.

- ▶ Open the boot.

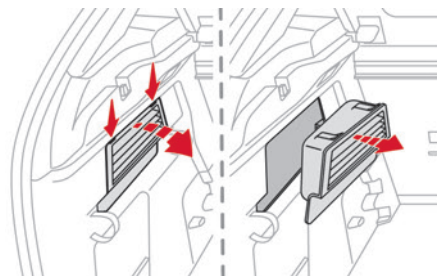

- ▶ Remove the access flap on the corresponding side trim:

- Press each of the notches in the upper part of the flap to unclip it.
- Tilt the flap and its support then extract the assembly.
- ▶ Disconnect the lamp unit connector.
- ▶ Unlock the nut using a 10 mm pipe wrench then unscrew and remove it. **Be careful not to drop it.**
- ▶ Dismantle the lamp unit and carefully extract it, pulling it straight towards the outside.

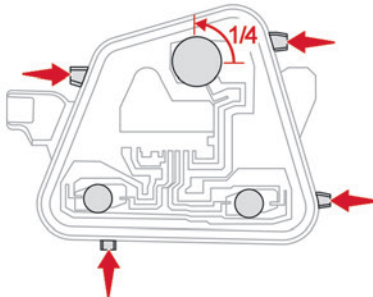

- ▶ Unclip the bulb holder and remove it. Be careful not to disconnect the wiring harness.
- ▶ For the brake lamp, turn the bulb a quarter turn and replace it.
- ▶ For the reversing lamp and direction indicator, pull the bulb out and replace it.

- i** Make sure to engage the lamp unit in its guides while keeping it in line with the vehicle.
- Tighten sufficiently to ensure sealing, but without damaging the lamp unit.

Foglamp (P21W)

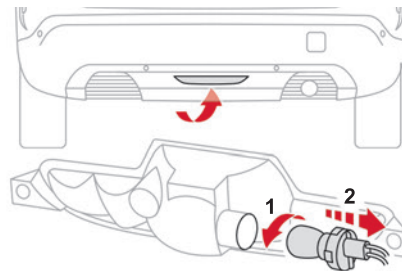

For access, pass your hand under the bumper on the left-hand side.

- ▶ Turn the bulb holder a quarter turn to the left and pull it out.
- ▶ Turn the bulb a quarter turn to the left and pull it out.
- ▶ Replace the bulb.

Fuses

- !** **Changing a fuse**
- All work must be carried out only by a CITROËN dealer or a qualified workshop

The replacement of a fuse by a third party could cause a serious malfunction of the vehicle.

i Installing electrical accessories

The vehicle's electrical system is designed to operate with standard or optional equipment.

Before fitting other electrical equipment or accessories to your vehicle, contact a CITROËN dealer or a qualified workshop.

! CITROËN accepts no responsibility for the cost incurred in repairing the vehicle or for rectifying malfunctions resulting from the installation of accessories not supplied or not recommended by CITROËN and not installed in accordance with its recommendations, in particular when the combined power consumption of all of the additional equipment connected exceeds 10 milliamperes.

12 V battery / Accessory battery

Lead-acid starter batteries



These batteries contain harmful substances (sulphuric acid and lead). They must be disposed of in accordance with regulations and must never under any circumstances be discarded with household waste.

Dispose of used batteries at a designated collection point.



! Protect your eyes and face before handling the battery.

All operations on the battery must be carried out in a well ventilated area and away from naked flames and sources of sparks, to avoid any risk of explosion or fire.

Wash your hands afterwards.



! Frozen battery

Never try to charge a frozen battery - risk of explosion!

If the battery has frozen, have it checked by a CITROËN dealer or by a qualified workshop, who will verify that the internal components have not been damaged and that the case has not cracked, which could lead to a risk of leakage of toxic and corrosive acid.



! Automatic gearbox

Never try to start the engine by pushing the vehicle.

Electric motor



i Flat accessory battery

It is no longer possible to start the motor or recharge the traction battery.



! Precautions before working on the accessory battery

Select mode **P**, switch off the ignition, check that the instrument panel is off and that the vehicle is not being charged.



! Jump-starting another vehicle

Do not use the accessory battery to jump-start another vehicle or to charge another vehicle's battery.

Symbols



No sparks or naked flames, no smoking.



Always protect your eyes. Explosive gases can cause blindness and injury.



Keep the vehicle's battery out of the reach of children.



The vehicle's battery contains sulphuric acid which can make you go blind or cause severe burns.



For more information, refer to the handbook.

Explosive gases can be present close to the battery.

Accessing the battery

The battery is located under the bonnet.

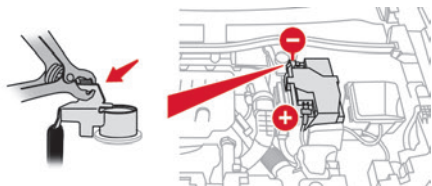

For access to the (+) terminal:

- ▶ Release the bonnet by pulling the internal release lever, then the external safety catch.
- ▶ Raise the bonnet.

(+) Positive terminal with a quick-release terminal.

(-) Negative terminal.

Starting using another battery

If the vehicle's battery is flat, the engine can be started using a backup battery (either external or from another vehicle) and jump leads or using a battery booster.

! Never start the engine by connecting a battery charger.

Never use a 24 V or higher battery booster.

Check beforehand that the backup battery has a nominal voltage of 12 V and a capacity at least equal to that of the discharged battery.

The two vehicles must not be in contact with each other.

Switch off all electricity-consuming equipment on both vehicles (audio system, wipers, lighting, etc.).

Make sure that the jump leads are well away from the engine's moving parts (fan, belt, etc.).

Do not disconnect the (+) terminal while the engine is running.

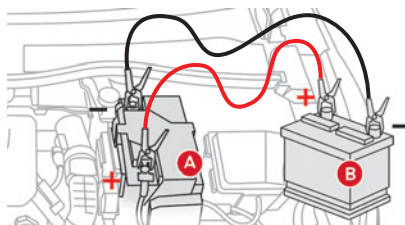

▶ Lift the plastic cover on the (+) terminal, if the vehicle has one.

▶ Connect the red cable to the (+) terminal of flat battery **A** (at the metal elbow), then to the (+) terminal of the backup battery **B** or of the booster.

▶ Connect one end of the green or black cable to the (-) terminal of the backup battery **B** or of

the booster (or to an earth point on the assisting vehicle).

▶ Connect the other end of the green or black cable to the (-) terminal of flat battery **A**.

▶ Start the engine on the assisting vehicle and leave it running for a few minutes.

▶ Operate the starter on the broken down vehicle and let the engine run.

If the engine does not start immediately, switch off the ignition and wait a few moments before trying again.

▶ Wait for it to return to idle.

▶ Disconnect the jump leads **in reverse order**.

▶ Refit the plastic cover to the (+) terminal, if the vehicle has one.

▶ Allow the engine to run for at least 30 minutes, with the vehicle stationary, so that the battery reaches an adequate state of charge.

! Driving immediately without having reached a sufficient level of charge may affect some of the vehicle's functions (e.g. Stop & Start).

Charging the battery using a battery charger

For optimum service life of the battery, it is essential to maintain an adequate state of charge.

In some circumstances, it may be necessary to charge the battery:

- When using the vehicle mainly for short journeys.
 - If the vehicle is to be taken off the road for several weeks.
- Contact a CITROËN dealer or a qualified workshop.

! To charge the vehicle's battery yourself, use only a charger compatible with lead-acid batteries with a nominal voltage of 12 V.

! Follow the instructions provided by the manufacturer of the charger. Never reverse polarities.

i It is not necessary to disconnect the battery.

- ▶ Switch the ignition off.
- ▶ Switch off all electrical consumers (audio system, lighting, wipers, etc.).

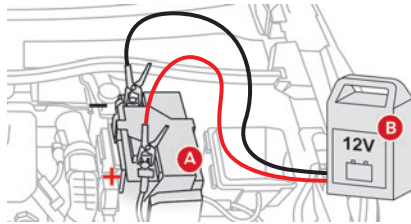

- ▶ Switch off charger **B** before connecting the cables to the battery, so as to avoid any dangerous sparks.

- ▶ Ensure that the charger cables are in good condition.
- ▶ Lift the plastic cover on the (+) terminal, if the vehicle has one.
- ▶ Connect the cables of charger **B** as follows:
 - the positive (+) red cable to the (+) terminal of battery **A**.
 - the negative (-) black cable to the (-) terminal of battery **A**.
- ▶ At the end of the charging operation, switch off charger **B** before disconnecting the cables from battery **A**.

! If this label is present, use only a 12 V charger to avoid causing irreversible damage to the electrical components.

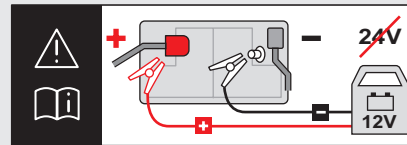

Disconnecting the battery

In order to maintain an adequate state of charge for starting the engine, we recommend disconnecting the battery if the vehicle is to be unused for an extended period.

Before disconnecting the battery:

- ▶ Close all openings (doors, boot, windows, roof).

- ▶ Switch off all electricity-consuming devices (audio system, wipers, lamps, etc.).
- ▶ Switch off the ignition and wait for 4 minutes. After accessing the battery, it is only necessary to disconnect the (+) terminal.

Quick-release terminal clamp

Disconnecting the (+) terminal

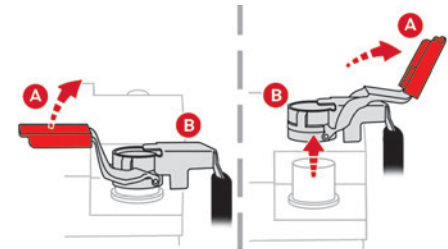

- ▶ Depending on equipment, lift the plastic cover on the (+) terminal.
- ▶ Raise lever **A** fully to release clamp **B**.
- ▶ Remove clamp **B** by lifting it off.

Reconnecting the (+) terminal

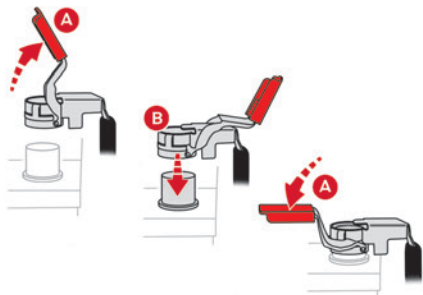

- ▶ Raise lever **A** fully.
- ▶ Refit open clamp **B** on the (+) terminal.
- ▶ Push clamp **B** fully down.
- ▶ Lower lever **A** to lock clamp **B**.
- ▶ Depending on equipment, lower the plastic cover on the (+) terminal.

! Do not force the lever when pressing on it, as if the clamp is not positioned correctly, locking will then not be possible. Start the procedure again.

Following reconnection

After reconnecting the battery, turn on the ignition and wait 1 minute before starting the engine, to enable the electronic systems to initialise.

If minor problems nevertheless persist following this operation, contact a CITROËN dealer or a qualified workshop.

Referring to the relevant section, reinitialise certain equipment:

- Remote control key or electronic key (depending on version).
- Sunroof.
- Electric windows.
- Date and time.
- Preset radio stations.

i The Stop & Start system may not be operational during the trip following the first engine start.

In this case, the system will only be available again after a continuous period with the vehicle immobilised, the duration of which depends on the exterior temperature and the state of charge of the battery (up to about 8 hours).

Towing the vehicle

i General recommendations

Observe the legislation in force in the country where you are driving. Ensure that the weight of the towing vehicle is higher than that of the towed vehicle. The driver must remain at the wheel of the towed vehicle and must have a valid driving licence.

When towing a vehicle with all four wheels on the ground, always use an approved towing arm; rope and straps are prohibited.

The towing vehicle must move off gently. When the vehicle is towed with its engine off, there is no longer braking and steering assistance.

! A professional towing service must be called if:

- Broken down on a motorway or main road.
- Not possible to put the gearbox into neutral, unlock the steering, or release the parking brake.
- Not possible to tow a vehicle with an automatic gearbox, with the engine running.
- Towing with only two wheels on the ground.
- Four-wheel drive vehicle.
- No approved towbar available.

! Before towing the vehicle, it is essential to put the vehicle in free-wheeling mode.

For more information on **Free-wheeling**, refer to the corresponding section.

i Electric motor

An electric vehicle cannot under any circumstances be used to tow another vehicle. However, it may be used, for example, to exit a rut.

Type of vehicle (engine/gearbox)	Towing constraints			
	Front wheels on the ground	Rear wheels on the ground	Flatbed	4 wheels on the ground with towbar
Internal combustion/Manual	✓	✓	✓	✓
Internal combustion/Automatic	✗	✓	✓	✗
Electric	✗	✓	✓	✗

i In case of battery or electric parking brake failure, it is essential to call a professional using flatbed recovery vehicles (excluding manual gearbox).

Accessing the tools

The towing eye is stored with the tool kit in the boot.

For more information on accessing the **Tool kit**, refer to the corresponding section.

Towing your vehicle

To access the front screw thread:

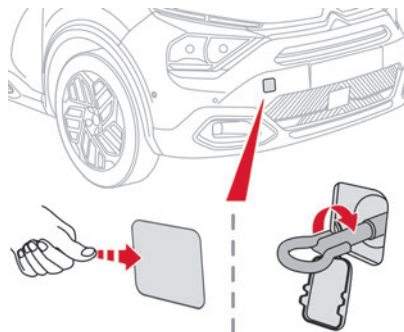

- ▶ Unclip the cover by pressing on its left-hand section.
- ▶ Release the cover downwards.

To be towed:

- ▶ Screw the towing eye in fully.
- ▶ Install the towbar.
- ▶ Put the gearbox into neutral.

! Failure to observe this instruction could result in damage to certain components (braking, transmission, etc.) and to the absence of braking assistance the next time the engine is started.

! **Automatic gearbox**
Never tow the vehicle with the driving wheels on the ground and the engine off.

- ▶ Unlock the steering and release the parking brake.

In the event of a breakdown

- ▶ Switch on the hazard warning lamps on both vehicles.
- ▶ Move off gently, drive slowly and only for a short distance.

Towing another vehicle

To access the rear screw thread:

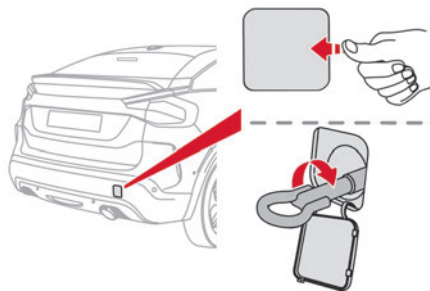

- ▶ Unclip the cover by pressing at its right-hand section.
- ▶ Pull the cover downwards.

To tow:

- ▶ Screw the towing eye in fully.
- ▶ Install the towbar.
- ▶ Switch on the hazard warning lamps on both vehicles.
- ▶ Move off gently, drive slowly and only for a short distance.

Engine technical data and towed loads

Engines

The engine characteristics are given in the vehicle's registration document, as well as in sales brochures.

Only the values available at the time of publication are presented in the tables. Contact a CITROËN dealer or a qualified workshop to obtain missing values.

i The maximum power corresponds to the value type-approved on a test bed, under conditions defined by European legislation (Directive 1999/99/EC).

For more information, contact a CITROËN dealer or a qualified workshop.

Weights and towed loads

The weights and towed loads relating to the vehicle are indicated on the registration document, as well as in sales brochures.

These values are also indicated on the manufacturer's plate or label.

For more information, contact a CITROËN dealer or a qualified workshop.

The GTW (Gross Train Weight) and towed load values indicated are valid up to a maximum altitude of 1,000 metres. The towed load value

must be reduced by 10% for each additional 1,000 metres of altitude.

The maximum authorised nose weight corresponds to the weight permitted on the towball.

! When exterior temperatures are high, the vehicle performance may be limited in order to protect the engine. When the exterior temperature is higher than 37°C, reduce the towed weight.

! Towing even with a lightly loaded vehicle can adversely affect its road holding. Braking distances are increased when towing a trailer. When using a vehicle to tow, never exceed a speed of 62 mph (100 km/h) (observe the local legislation in force).

Engines and towed loads - Petrol

Engines	PureTech 100 S&S	PureTech 130 S&S	PureTech 130 S&S	PureTech 155 S&S
Gearboxes	BVM6 (Manual 6-speed)	BVM6 (Manual 6-speed)	EAT8 (Automatic 8-speed)	EAT8 (Automatic 8-speed)
Codes	EB2ADTD_B MB6 STTd	EB2ADTS MB6 STTd	EB2ADTS ATN8 STTd	EB2ADTX ATN8 STTd
Model codes	BAHNEA	BAHNSA	BAHNSB	BAHNNB
Cubic capacity (cc)	1,199	1,199	1,199	1,199
Max. power: EC standard (kW)	75	96	96	114
Fuel	Unleaded	Unleaded	Unleaded	Unleaded
Braked trailer (within the GTW limit) (kg) on a 10% or 12% gradient	1,000	1,200	1,200	1,200
Unbraked trailer (kg)	640	660	680	670
Maximum authorised nose weight (kg)	61	61	61	61

Engines and towed loads - Diesel

Engines	BlueHDi 110	BlueHDi 130
Gearboxes	BVM6 (Manual 6-speed)	EAT8 (Automatic 8-speed)
Codes	DV5RCe MB6 STTd	DV5RC ATN8 STTd
Model codes	BBYHSA	BBYHZB
Cubic capacity (cc)	1,499	1,499
Max. power: EC standard (kW)	81	96
Fuel	Diesel	Diesel
Braked trailer (within the GTW limit) (kg) on a 10% or 12% gradient	1,200	1,200
Unbraked trailer (kg)	660	690
Maximum authorised nose weight (kg)	61	61

Electric motor

Model codes:	BCZKXC
Braked trailer (within the GTW limit) (kg) on a 10% or 12% gradient	0
Unbraked trailer (kg)	0
Maximum authorised nose weight (kg)	0
Electric motor	
Technology	Synchronous with permanent magnets
Max. power : EC standard (kW)/(hp)	100/136
Traction battery	
Technology	Lithium-Ion
Installed capacity (kWh)	50
Domestic charging	Mode 2
Alternating current (AC) voltage Rating (A)	230 (single-phase) 8 or 16
Accelerated charging	Mode 3
Alternating current (AC) voltage Rating (A)	230 (single-phase or three-phase) 16 or 32
Superfast charging	Mode 4
Direct current (DC) voltage	400

Dimensions (mm)

These dimensions have been measured on an unladen vehicle.

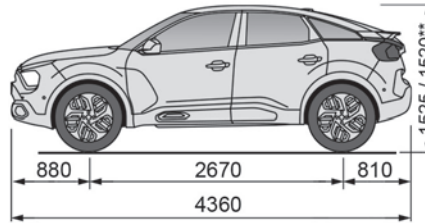
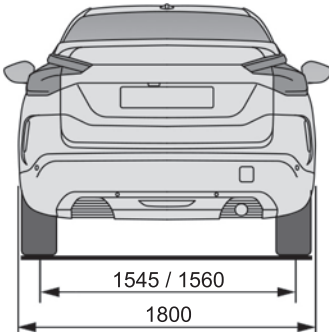
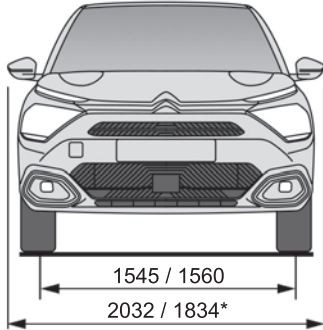

- * Mirrors folded
- ** Electric versions

Identification markings

Various visible markings for vehicle identification and vehicle search.

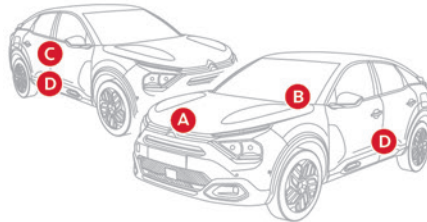

A. Vehicle Identification Number (VIN), under the bonnet.

Stamped on the chassis.

B. Vehicle Identification Number (VIN), on the dashboard.

Printed on an adhesive label visible through the windscreen.

C. Manufacturer's label.

Affixed to the right-hand door.
Bears the following information:

- Manufacturer's name.
- European whole vehicle type approval number.
- Vehicle Identification number (VIN).
- Gross vehicle weight (GVW).
- Gross train weight (GTW).
- Maximum weight on the front axle.
- Maximum weight on the rear axle.

D. Tyres/paint code label.

Affixed to the driver's door.

Bears the following information about the tyres:

- Tyre pressures, unladen and laden.
- Tyre specification, made up of the dimensions and type as well as the load and speed indices.
- Spare tyre inflation pressure.

Also indicates the paint colour code.

i The vehicle may be originally equipped with tyres with higher load and speed indices than those indicated on the label, without affecting tyre pressure (on cold tyres). In the event of a change in the type of tyres, contact a CITROËN dealer for the tyre fits approved for the vehicle.

Touch screen BLUETOOTH audio system

Multimedia audio system - Bluetooth® telephone

i The functions and settings described vary according to the vehicle version and configuration.

! For safety reasons and because they require sustained attention by the driver, the following operations must be carried out with the **vehicle stationary** and the ignition on:

- Pairing the smartphone with the system in Bluetooth mode.
- Using the smartphone.
- Changing the system settings and configuration.

i The system is protected in such a way that it will only operate in the vehicle. The **Energy Economy Mode** message is displayed when the system is about to enter the corresponding mode.

First steps



With the engine running, a press mutes the sound.

With the ignition off, a press turns the system on.



Increase or decrease the volume using the thumbwheel on the left-hand side.



To access the menus, press this button on the touch screen.

Press the back arrow to go back a level.



To clean the screen, use a soft, non-abrasive cloth (e.g. spectacles cloth) with no additional product.
Do not use sharp objects on the screen.
Do not touch the screen with wet hands.

Certain information is displayed permanently in the upper bar of the touch screen:

- Air conditioning information (depending on version).
- Bluetooth connection.
- Indication of location data sharing.

Selection of the audio source:

- FM/AM/DAB radio stations (depending on equipment).
- Telephone connected via Bluetooth and Bluetooth multimedia broadcast (streaming).
- USB memory stick.
- Media player connected via the auxiliary socket (depending on equipment).



In very hot conditions, the volume may be limited to protect the system. It may

go into standby (screen and sound off) for at least 5 minutes.

The return to normal takes place when the temperature in the passenger compartment has dropped.

Steering mounted controls

Steering mounted controls - Type 1



Radio:

Select the previous/next preset radio station.

Select the previous/next item in a menu or a list.

Media:

Select the previous/next track.

Select the previous/next item in a menu or a list.



Radio:

Short press: display the list of radio stations.

Long press: update the list.

Media:

Short press: display the list of folders.

Long press: display the available sorting options.



Short press: change audio source (radio; USB; AUX if equipment connected; CD; streaming).

Long press: display the call log.

Short press during an incoming call: accept the call.

Short press during a call in progress: end the call.



Confirm a selection.



Increase volume.



Decrease volume.



Mute/restore sound by simultaneously pressing the increase and decrease volume buttons.

Steering mounted controls - Type 2



Voice commands:

This control is located on the steering wheel or at the end of the lighting control stalk (depending on equipment).

Short press, smartphone voice commands via the system.



Increase volume.



Decrease volume.

Mute by pressing the volume increase and decrease buttons simultaneously (depending on equipment).

Restore the sound by pressing one of the two volume buttons.



Change the multimedia source.



Short press: display the calls log.
Short press during an incoming call: accept the call.

Long press during an incoming call: reject the call.

Short press during a call in progress: end the call.



Radio (rotate): previous/next preset station.

Media (rotate): previous/next track, move in a list.

Short press: confirm a selection; if nothing selected, access to presets.



Radio: display the list of stations.

Media: display the list of tracks.

Menus

Radio

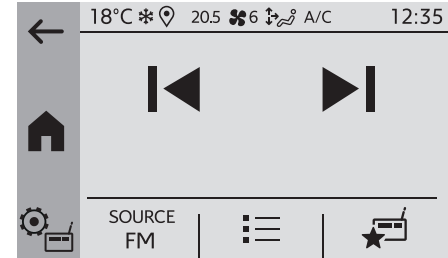

Select a radio station.

Media

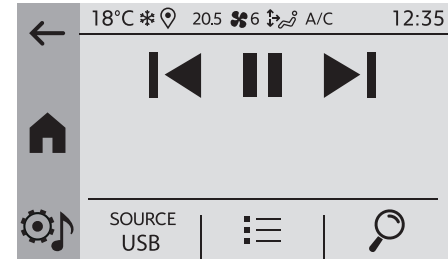

Select an audio source.

Telephone

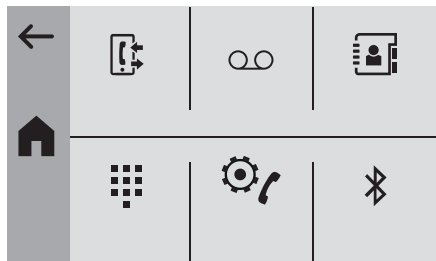

 Connect a mobile phone via Bluetooth®.

Driving

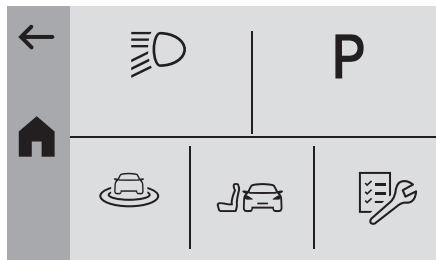

 Activate, deactivate or configure certain vehicle functions (depending on equipment/version).

Settings

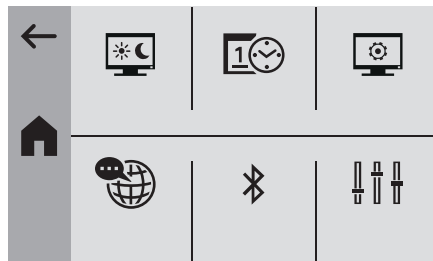

 Adjust the sound settings (balance, ambience, etc.), the display (language, units, date, time, etc.) or configure the system (privacy).

Air conditioning/Heating

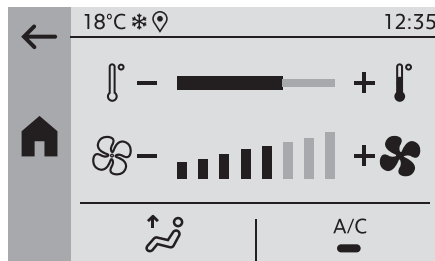

Depending on equipment/Depending on version.

 Manage various temperature and air flow settings.

Radio

Choose the band

 Press the "Radio" menu.

Press the "SOURCE" button.

Choose the band: **FM**, **AM** or **DAB**, depending on equipment.

Selecting a station

 Press one of the buttons for an automatic search for radio stations.

Or

 Press on the displayed frequency.

 Enter the FM and AM waveband values using the virtual keypad.

Or

 Press this button to display the list of stations received and available on the waveband.

 Radio reception may be affected by the use of electrical equipment not approved by the Brand, such as a USB charger connected to the 12 V socket. The exterior environment (hills, buildings, tunnels, basement car parks, etc.) may block reception, including in RDS mode. This behaviour is normal in propagation of radio waves and does not indicate any failure of the audio system.

Presetting a station

Select a radio station or frequency.



Press the "**Presets**" button.

Make a long press on an empty line to preset the station. An audible signal confirms the presetting of the station.

It is possible to preset up to 16 stations.

- i** To replace a preset station by the currently playing station, make a long press on the preset station.

Activating/Deactivating RDS

RDS, if activated, allows you to continue listening to the same station by automatically retuning to alternative frequencies.

- i** In certain conditions, tracking may not be assured throughout the entire country as radio stations do not cover 100% of the territory. This explains the loss of reception of the station during a journey.



Press the "**Radio Settings**" button.



Activate/Deactivate "**RDS options**".

Playing TA messages

The TA (Traffic Announcement) function gives priority to TA alert messages.

To operate, this function needs good reception of a radio station that transmits this type of message. While traffic information is being broadcast, the current media is automatically interrupted so that the TA message can be heard. Normal play of the media previously playing is resumed at the end of the message.



Press the "**Radio Settings**" button.



Activate/Deactivate "**Traffic announcement (TA)**".

Audio settings



Press the "**Radio Settings**" button.

In the list, select "**Audio Settings**".

Activate/deactivate and configure the available options (sound balance, ambiances, etc.).

- i** The sound balance/distribution is audio processing that allows the quality of the sound to be adapted according to where the passengers are sitting in the vehicle.

DAB (Digital Audio Broadcasting) radio

Terrestrial Digital Radio

Choosing the DAB radio

Terrestrial digital radio (DAB) provides higher quality reception.

The different "multiplexes/ensembles" offer a choice of radio stations arranged in alphabetical order.



Press the "**Radio**" menu.

Press the "**SOURCE**" button.

In the list of available sources, choose "**DAB Radio**".

Activating FM-DAB Tracking

"DAB" does not cover 100% of the territory. When the digital radio signal is poor, the "FM-DAB tracking" allows you to continue listening to the same station, by automatically switching to the corresponding "FM" analogue station (if there is one).



Press the "**Radio Settings**" button.



Activate "**DAB-FM**".

- i** If "FM-DAB tracking" is activated, there may be a difference of a few seconds

when the system switches to "FM" analogue radio with sometimes a variation in volume. Once the digital signal quality is restored, the system automatically changes back to "DAB".

! If the "DAB" station being listened to is not available on "FM", or if the "FM-DAB tracking" is not activated, the sound will cut out while the digital signal is too weak.

Media

Selecting the source



Press the "**Media**" menu.

Press the "**SOURCE**" button.

Select the source (USB, Bluetooth or AUX, depending on equipment).

USB port



Insert the USB memory stick into the USB port or connect the USB device to the USB port using a suitable cable (not supplied).

! To protect the system, do not use a USB hub.

The system builds playlists (in temporary memory); this operation can take from a few seconds to several minutes at the first connection.

Playlists are updated whenever a USB memory stick is connected or the contents of a particular USB memory stick are changed. The lists are memorised: if they are not modified, the subsequent loading time will be shorter.

Auxiliary (AUX) jack socket

Depending on equipment



Connect a portable device (MP3 player, etc.) to the auxiliary jack socket using an audio cable (not supplied).

This source is only available if "**Aux**

Amplification" has been selected in the audio settings.

First adjust the volume on the portable device (to a high level). Then adjust the volume of the audio system.

Controls are managed via the portable device.

Bluetooth®streaming

Streaming allows you to listen to music from your smartphone.

The Bluetooth profile must be activated, first adjust the volume on the portable device (to a high level).

Then adjust the volume of the system.

If play does not start automatically, it may be necessary to start the audio playback from the smartphone.

Control is from the portable device or by using the system's touch buttons.

! Once connected in Streaming mode, the smartphone is considered to be a media source.

Connecting Apple® players

Connect the Apple® player to the USB socket using a suitable cable (not supplied).

Play starts automatically.

Control is via the audio system.

i The classifications available are those of the portable device connected (artists/albums/genres/playlists/audio books/podcasts). It is also possible to use a classification structured in the form of a library.

The default classification used is by artist. To modify the classification used, return to the first level of the menu then select the desired classification (playlists for example) and confirm to go down through the menu to the desired track.

The version of software in the audio system may not be compatible with the generation of the Apple® player.

Media settings



Press the "**Media Settings**" button.

Activate/deactivate track playback options and access the audio settings.

i The audio settings are the same as the audio settings for the radio. For more information on the "**Audio settings**", refer to the corresponding section.

Information and advice

The system supports USB mass storage devices, BlackBerry® devices or Apple® players via the USB ports. The adapter cable is not supplied.

Devices are managed using the audio system controls.

Other devices, not recognised on connection, must be connected to the auxiliary socket using a jack cable (not supplied) or via Bluetooth streaming, if compatible.

! To protect the system, do not use a USB hub.

The audio system will only play audio files with ".wav", ".wma", ".aac", ".mp3", ".mp4", ".m4a", ".flac", ".ogg" file extensions and with a bit rate of between 32 Kbps and 320 Kbps (300 Kbps maximum for ".flac" files).

It also supports VBR (Variable Bit Rate) mode.

All ".wma" files must be standard WMA 9 files.

The supported sampling rates are 11, 22, 44 and 48 KHz.

To avoid reading and display problems, we recommend choosing file names less than 20 characters long that do not contain any special characters (e.g. " ? ; ù).

Use only USB memory sticks in FAT or FAT32 format (File Allocation Table).

i We recommend using the original USB cable for the portable device.

Telephone

Pairing a Bluetooth® telephone

Up to 10 phones can be paired to the system. Activate the Bluetooth function on the telephone beforehand and ensure that it is "visible to all" (telephone configuration).

To complete the pairing, whichever procedure is used (from the telephone or from the system), ensure that the code is the same in the system and in the telephone.

! The services available depend on the network, the SIM card and the compatibility of the Bluetooth devices used. Check for services availability in the phone's manual and with the operator.

i The profiles compatible with the system are: HFP, OPP, PBAP, DID, A2DP, AVRCP, SPP and PAN.

Go to the Brand's website for more information (compatibility, additional help, etc.).

Procedure from the telephone



Select the name of the system in the list of devices detected.

In the system, accept the connection request from the telephone.

Procedure from the system



Press the **Home** button to access the menus.



Select the "**Telephone**" menu.

Press "**Management connections**".

The list of telephones detected is displayed.

Select the name of the telephone in the list.

The system offers to connect the telephone with two profiles:

- as "**Telephone**": hands-free kit, telephone only.
- as "**Streaming**": wireless playing of audio files on the telephone.

! The system cannot be connected to multiple telephones with the same profile.

No more than 2 phones can be connected simultaneously (**1 per profile**).

i The Bluetooth profiles chosen on the phone have priority over the profiles selected on the system.

If the pairing procedure fails, it is recommended that you deactivate and then reactivate the Bluetooth function on the telephone.

i Depending on the type of telephone, the option is given to accept or not accept the transfer of contacts and the call log.

Automatic reconnection

On return to the vehicle, if the last telephone connected is present again, it is automatically recognised and within about 30 seconds of switching on the ignition, the pairing is established automatically (Bluetooth activated).

Managing paired telephones

To connect or disconnect a paired telephone:



Select the **"Telephone"** menu.



Press **"Bluetooth"** to display the list of paired devices.

Press on the name of the telephone chosen in the list to disconnect it.

Press again to connect it.

Deleting a telephone



Press the **"Bluetooth"** button.

Press **"Manage connections"**.

In the displayed window select **"Delete"**.

The list of paired devices is displayed.

Press on the name of the telephone to delete.

Receiving a call

An incoming call is announced by a ring and a superimposed display in the screen.

To accept the call:



Make a short press on the steering mounted **TEL** button.

To reject the call:



Make a long press



on the steering mounted **TEL** button.

Or



Press **"End call"** on the touch screen.

Making a call



Using the telephone is not recommended while driving.

Parking the vehicle.

Make the call using the steering mounted controls.

Calling a new number



Press **"Telephone"**.



Press the **"Keypad"** button.

Enter the phone number using the digital keypad.



Press **"OK"** to start the call.

Calling a contact



Press the **"Telephone"** menu.



Or make a long press



on the steering mounted **TEL** button.

Press **"Contacts"**.

Select the desired contact from the list offered.

Calling a recently used number



Press **"Telephone"**.

Press **"Calls"**.

Or



Make a long press



on the steering mounted **TEL** button.

Select the desired contact from the list offered.



A call in progress remains active in the vehicle for 10 minutes after switching off the ignition. After that, the system switches off and the call automatically redirects to the telephone.



It is always possible to make a call directly from the telephone; as a safety measure, first park the vehicle.

Settings

Adjusting the brightness



Press "Settings".

Select "Display".



Press the buttons to adjust the brightness of the screen and/or of the instrument panel (depending on version).

Modifying system settings



Press "Settings".

Press "System".



Press "Privacy" to access the privacy settings.



Select "Units" to change the units of distance, fuel consumption and temperature.



Press "Factory settings" to return to the initial settings.



Press "System Info" to check the system version.

Privacy settings

Three data privacy options are available:



"No data sharing (data, vehicle position)"



"Only data sharing"



"Data and vehicle position sharing"



When data and vehicle position sharing are enabled, this symbol is displayed in the upper bar of the touch screen.

Selecting the language



Press "Settings".



Select "Languages" to change the language.

Setting the date and time



Press "Settings".



Press "Date/Time".

Setting the date:



Press the arrows to set the day, month and year.



First set the day, then the month.

Setting the time:



Press these buttons to set hours and minutes.



Select or deselect the 24h format.



In 12h format, choose "AM" or "PM".



The system does not automatically manage the change between winter and summer time.

Date format:



Select the display format for the date.

Frequently asked questions

The following information groups together the answers to the most frequently asked questions concerning the system.

Radio

The reception quality of the tuned radio station gradually deteriorates or the station presets are not working (no sound, 87.5 MHz is displayed, etc.).

The vehicle is too far from the selected station's transmitter, or no transmitter is present in the geographical area.

► Activate the "RDS" function in the upper bar to enable the system to check whether there is a more powerful transmitter in the geographical area.

The environment (hills, buildings, tunnels, basement car parks, etc.) is blocking reception, including in RDS mode.

This is a perfectly normal phenomenon, and is not indicative of an audio system malfunction.

The aerial is missing or has been damaged (for example while entering a car wash or underground car park).

► Have the aerial checked by a dealer.

I cannot find some radio stations in the list of received stations.

The name of the radio station changes.

The station is no longer received or its name has changed in the list.

Some radio stations send other information in place of their name (the title of the song for example).

The system interprets these details as the station name.

▶ Press the "**Radio Settings**" button then select "Update list". The radio reception is cut off while searching for available stations (approximately 30 seconds).

Media

Playback of my USB memory stick starts only after a very long wait (around 2 to 3 minutes).

Some files supplied with the memory stick may greatly slow down access to reading the memory stick (multiplication by 10 of the cataloguing time).

▶ Delete the files supplied with the memory stick and limit the number of sub-folders in the file structure on the memory stick.

Some characters in information about the currently playing media are not displayed correctly.

The audio system is unable to process certain types of character.

▶ Use standard characters to name tracks and folders.

Playback of streaming files does not start.

The connected device does not automatically launch playback.

▶ Start playback from the device.

Track names and playing times are not displayed on the audio streaming screen.

The Bluetooth profile does not allow the transfer of this information.

Telephone

I cannot connect my Bluetooth telephone.

The telephone's Bluetooth function may be switched off or the telephone may not be visible.

▶ Check that the telephone has Bluetooth switched on.

▶ Check in the telephone settings that it is "visible to all".

The Bluetooth telephone is not compatible with the system.

▶ Check the compatibility of the telephone on the Brand's website (services).

The volume of the telephone connected in Bluetooth mode is inaudible.

The volume depends on both the system and the telephone.

Ambient noise affects the quality of the telephone call.

▶ Increase the volume of the audio system, to maximum if required, and increase the volume of the telephone if necessary.

▶ Reduce ambient noise (close windows, reduce ventilation, slow down, etc.).

The contacts are not listed in alphabetical order.

Some telephones offer display options.

Depending on the settings chosen, contacts can be transferred in a specific order.

▶ Modify the telephone directory display settings.

Settings

When the treble and bass settings are changed, the ambience is deselected.

When the ambience is changed, the treble and bass settings are reset.

Selecting an ambience imposes the treble and bass settings, and vice versa.

▶ Modify the treble and bass or ambience settings to obtain the desired musical ambience.

There is a difference in sound quality between audio sources.

To allow for optimal listening quality, the sound settings can be tailored to different audio sources, which can generate audible differences when changing source.

▶ Check that the sound settings are appropriate to the sources listened to. Adjust the sound functions to the middle position.

When the engine is off, the system switches off after several minutes of use.

When the engine is switched off, the system's operating time depends on the state of charge of the battery.

The switch-off is normal: the system automatically goes into energy economy mode and switches off to maintain an adequate charge in the battery.

- ▶ Start the vehicle's engine to increase the charge of the battery.

MyCitroën Play

Multimedia audio system - Applications - Bluetooth® telephone

i The functions and settings described vary according to the vehicle version and configuration, as well as the country of sale.

! For safety reasons and because they require sustained attention by the driver, the following operations must be carried out with the **vehicle stationary** and the ignition on:

- Connecting the smartphone via Bluetooth, USB or Wi-Fi.
- Using the smartphone.
- Connecting to the CarPlay® or Android Auto applications (certain applications stop displaying when the vehicle is moving).
- Changing the system settings and configuration.

i The system is protected so that it only operates in the vehicle. The message **Energy economy mode** is displayed when the system is about to go into standby.

i The system's Open Source Software (OSS) source codes are available at the following addresses:
<https://www.groupe-psa.com/fr/oss/>
<https://www.groupe-psa.com/en/oss/>

First steps



With the engine running, a press mutes the sound.

With the ignition off, a press turns the system on. Increase or decrease the volume using the wheel or the "plus" or "minus" buttons (depending on the equipment).

Use the buttons on either side of or below the touch screen to access the menus, then press the virtual buttons on the touch screen. Depending on the model, use the "Source" and "Menu" buttons below the touch screen to access the menus, then press the virtual buttons on the touch screen.

At all times it is possible to display the rolling menus by pressing the screen briefly with three fingers.

On pages with multiple tabs at the bottom of the screen, you can switch between pages either by tapping the tab for the desired page or by swiping the pages to the left or right with your finger.

Press the back arrow to go back a level or confirm.

! The touch screen is of the "capacitive" type.

To clean the screen, use a soft, non-abrasive cloth (e.g. spectacles cloth) with no additional product.

Do not use sharp objects on the screen. Do not touch the screen with wet hands.

Certain information is displayed permanently on the main screen:

- Air conditioning status information (depending on version), and direct access to the corresponding menu.
 - Radio Media and Telephone menu status information.
 - Privacy status information.
 - Access to the touch screen and digital instrument panel settings.
- Audio source selection (depending on equipment):
- FM/DAB/AM radio stations (depending on equipment).
 - Telephone connected via Bluetooth and Bluetooth multimedia broadcast (streaming).
 - USB Memory stick.

i In very hot conditions, the volume may be limited to protect the system. It may enter standby mode (with the screen and sound off) for 5 minutes or more. The system will resume normal operation when the temperature in the passenger compartment has dropped.

Steering mounted controls



Voice control: smartphone voice commands.



Increase volume.



Decrease volume.

Mute by pressing the volume increase and decrease buttons simultaneously (depending on equipment). Restore the sound by pressing one of the two volume buttons.



Telephone (short press): start telephone call.

Call in progress (short press): access telephone menu.

Telephone (long press): reject an incoming call, end call; when no call is in progress, access telephone menu.



Radio (rotate): automatic search for the previous/next station.

Media (rotate): previous/next track, move through a list.

Short press: confirm a selection; if nothing selected, access presets.

Menus

Radio Media

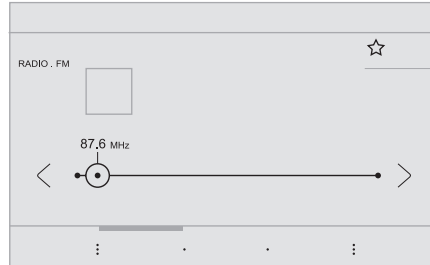

Select an audio source or radio station.

Telephone

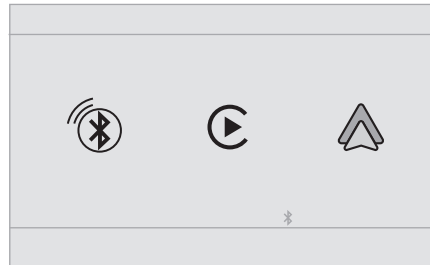

Connect a mobile phone via Bluetooth®. Run certain applications from a smartphone connected via CarPlay® or Android Auto.

Applications

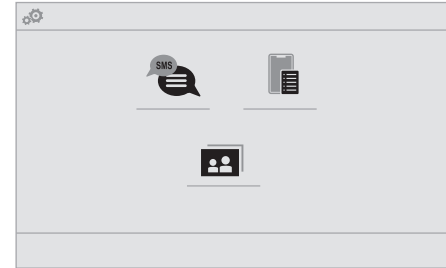

Access configurable equipment.

Settings

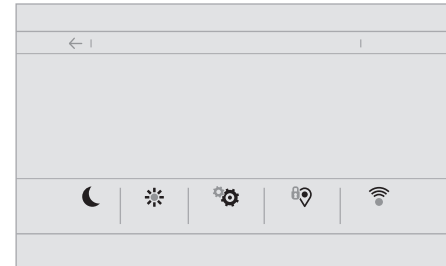

Configure the sound (balance, ambience, etc.), the display (language, units, date, time, etc.), and some system functions.

Driving



 Activate, deactivate or configure certain vehicle functions.

Navigation

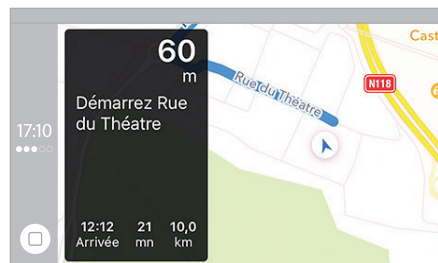

 Configure the navigation and select your destination via CarPlay® or Android Auto.

Air conditioning

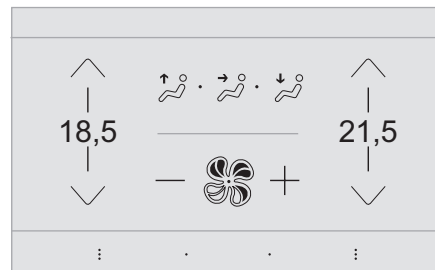



 Manage various temperature and air flow settings.

Radio

Selecting a station

Press **Radio Media** to display the main page.

  Press one of the buttons to perform an automatic search for radio stations.

Or

 Move the slider to manually search for frequencies up or down.

Or

 Press the frequency to enter the FM and AM waveband values using the virtual keypad.

 Press **"OK"** to confirm.

 Radio reception may be affected by the use of electrical equipment not approved by the Brand, such as a USB charger connected to the 12 V socket. The exterior environment (hills, buildings, tunnels, basement car parks, etc.) may block reception, including in RDS mode. This phenomenon is perfectly normal in the context of radio wave transmission, and in no way indicative of an audio system malfunction.

Changing the waveband

 Press **Radio Media** to display the main page.

Press the **"OPTIONS"** button to access the secondary page.

 Press **"Band"** to change waveband.

 Press in the shaded area to confirm.

Presetting a station

Select a radio station or frequency.

 Make a short press on the star outline. If the star is solid, the radio station is already preset.

Or

Select a radio station or frequency. Press **"Preset"**.

 Make a long press on one of the buttons to preset the station.

Activating/Deactivating RDS

RDS, if activated, allows you to continue listening to the same station by automatically retuning to alternative frequencies.

 Press **Radio Media** to display the main page.

Press the "**OPTIONS**" button to access the secondary page.

 Activate/deactivate "**RDS**".

 Press in the shaded area to confirm.

 RDS station tracking may not be available nationwide, as many radio stations do not cover 100 % of the country. This explains the loss of reception of the station during a journey.

Displaying text information

The "Radio Text" function displays information transmitted by the radio station relating to the station or the currently playing song.

 Press **Radio Media** to display the main page.

Press the "**OPTIONS**" button to access the secondary page.

 Activate/deactivate "**News**".

 Press in the shaded area to confirm.

Playing TA messages

The TA (Traffic Announcement) function gives priority to TA alert messages. To operate, this function needs good reception of a radio station that transmits this type of message. While traffic information is being broadcast, the current media is automatically interrupted so that the TA message can be heard. Normal play of the previously playing media resumes at the end of the message.

 Press **Radio Media** to display the main page.

Press the "**OPTIONS**" button to access the secondary page.

 Activate/deactivate "**TA**".

 Press in the shaded area to confirm.

Audio settings

 Press **Radio Media** to display the main page.

Press the "**OPTIONS**" button to access the secondary page.

 Press "**Audio settings**".

 Select the "**Tone**", "**Balance**" or "**Sound**" tab to configure the sound settings.

 Press the back arrow to confirm.

 In the "**Tone**" tab, the **Ambience**, **Bass**, **Medium** and **Treble** sound settings are

different and independent for each audio source.

In the "**Balance**" tab, the **All passengers**, **Driver** and **Front only** settings are common to all sources.

In the "**Sound**" tab, activate or deactivate "**Volume linked to speed**", "**Auxiliary input**" and "**Touch tones**".

 The balance/distribution (or spatialisation with the Arkamys® system) uses audio processing to adjust the sound quality according to the number of passengers in the vehicle.

 Onboard audio: Arkamys Sound Staging® optimises the sound distribution inside the passenger compartment.

DAB (Digital Audio Broadcasting) radio

Terrestrial Digital Radio

Digital radio provides higher quality sound. The various "multiplexes/ensembles" offer a choice of radio stations organised in alphabetical order.

 Press **Radio Media** to display the main page.

Press the **"OPTIONS"** button to access the secondary page.



Press **"Band"** to select **"DAB band"**.



Press in the shaded area to confirm.

FM-DAB Follow-up

"DAB" does not cover 100% of the territory. When the digital radio signal is poor, the "FM-DAB Follow-up" enables you to continue listening to the same station by automatically switching to the corresponding "FM" analogue station (if there is one).



Press **Radio Media** to display the main page.

Press the **"OPTIONS"** button to go to the secondary page.



Activate/deactivate **"FM-DAB Follow-up"**.



Press in the shaded area to confirm.

i If "FM-DAB Follow-up" is activated, there may be a time offset of a few seconds when the system switches to "FM" analogue radio, and in some cases a change in volume. When the digital signal quality is restored, the system automatically changes back to "DAB". To minimise this time lag, storing radio stations in the "DAB" band is recommended.

! If the "DAB" station being listened to is not available on "FM", or if "FM-DAB Follow-up" is not activated, the sound will cut out when the digital signal becomes too weak.

Media

USB port



Insert the USB memory stick into the USB port or connect the USB device to the USB port using a suitable cable (not supplied).

! To protect the system, do not use a USB hub.

The system builds playlists (in temporary memory); this operation can take from a few seconds to several minutes at the first connection.

Reduce the number of non-music files and the number of folders to reduce the waiting time. Playlists are updated whenever the ignition is switched off or a USB memory stick is connected. The audio system memorises these lists, which will subsequently load faster if they have not been changed.

Selecting the source



Press **Radio Media** to display the main page.

Press the **"SOURCES"** button.
Select the source.

BluetoothStreaming®

Streaming allows you to listen to the audio feed from your smartphone.

The Bluetooth profile must be activated.

First adjust the volume on the portable device (to a high level). Then adjust the volume of the system.

If play does not start automatically, it may be necessary to start the audio playback from the smartphone.

Control is from the portable device or by using the system's touch buttons.

i Once connected in Streaming mode, the smartphone is considered to be a media source.

Connecting Apple® players

Connect the Apple® player to the USB socket using a suitable cable (not supplied).

Play starts automatically.

Control is via the audio system.

i The classifications available are those of the portable device connected (artists/ albums/genres/playlists/audio books/podcasts). It is also possible to use a classification structured in the form of a library.

The default classification used is by artist. To modify the classification used, return to the first level of the menu then select the desired classification (playlists for example) and

confirm to go down through the menu to the desired track.

The version of software in the audio system may not be compatible with the generation of the Apple® player.

Information and advice

The system supports USB mass storage devices, BlackBerry® devices or Apple® players via the USB ports. The adapter cable is not supplied.

Devices are managed using the audio system controls.

Other devices, not recognised on connection, must be connected via Bluetooth streaming, if compatible.

! To protect the system, do not use a USB hub.

The audio system will only play audio files with ".wav", ".wma", ".aac", ".ogg" and ".mp3" file extensions, at bit rates between 32 Kbps and 320 Kbps.

It also supports VBR (Variable Bit Rate) mode. No other file types (".mp4", etc.) can be read.

All ".wma" files must be standard WMA 9 files.

The supported sampling rates are 11, 22, 44 and 48 KHz.

To avoid reading and display problems, we recommend choosing file names less than 20 characters long that do not contain any special characters (e.g. " ? . ; ù).

Use only USB memory sticks in FAT32 format (File Allocation Table).

i We recommend using the original USB cable for the portable device.

Telephone

Pairing a Bluetooth® telephone

! The services available depend on the network, the SIM card and the compatibility of the Bluetooth devices used. Consult the telephone user guide and the service provider to check which services are available.

The Bluetooth function must be activated and the telephone configured as "Visible to all" (in the telephone settings).

To complete the pairing, whichever procedure is used (from the telephone or from the system), ensure that the code is the same in the system and in the telephone.

i If the pairing procedure fails, we recommend deactivating and then reactivating the Bluetooth function on the telephone.

Procedure from the telephone



Select the name of the system in the list of detected devices.

In the system, accept the connection request from the telephone.

Procedure from the system



Press **Telephone** to display the main page.



Press **"Bluetooth search"**.

The list of detected telephones is displayed.



Select the name of the chosen telephone in the list.

Connection sharing

The system offers to connect the telephone with 3 profiles:

- **"Telephone"** (hands-free kit, telephone only),
- **"Streaming"** (streaming: wireless playing of audio files on the telephone),
- **"Mobile internet data"**.



Select one or more profiles.



Press **"OK"** to confirm.

Depending on the type of telephone, you may be prompted to accept the transfer of contacts and messages.

i The ability of the system to connect just one profile depends on the telephone. All three profiles may connect by default.

i The profiles compatible with the system are: HFP, OPP, PBAP, A2DP, AVRCP, MAP and PAN.

Visit the Brand's website for more information (compatibility, additional help, etc.).

Automatic reconnection

On returning to the vehicle, if the last telephone connected is present again, it is automatically recognised and within about 30 seconds after switching on the ignition, the pairing is established automatically (Bluetooth activated).

To modify the connection profile:

 Press **Telephone** to display the main page.

Press the **"PHONE"** button to access the secondary page.

 Press **"Bluetooth connection" to display the list of paired devices.**

 Press the "Details" button for a paired device.

 Select one or more profiles.

OK Press **"OK"** to confirm.

Managing paired telephones

This function lets you connect or disconnect a device or delete a pairing.

 Press **Telephone** to display the main page.

Press the **"PHONE"** button to access the secondary page.

 Press **"Bluetooth connection" to display the list of paired devices.**

 Press on the name of the telephone selected in the list to disconnect it.

Press again to connect it.

Deleting a telephone

 Press the basket at the top right of the screen to display a basket alongside the telephone chosen.

 Press the basket alongside the telephone chosen to delete it.

Receiving a call

An incoming call is announced by a ring and a superimposed display in the screen.

 Make a short press on the steering mounted **PHONE** button to accept an incoming call.

And

 Make a long press

 on the steering mounted **PHONE** button to reject the call.

Or

 Press **"End call"**.

Making a call

! Using the telephone is not recommended while driving.

Parking the vehicle.

Make the call using the steering mounted controls.

Calling a new number

 Press **Telephone** to display the main page.

 Enter the phone number using the digital keypad.

 Press **"Call" to start the call.**

Calling a contact

 Press **Telephone** to display the main page.

 Or press and hold

 the steering mounted **PHONE** button.

Press **"Contacts"**.

Select the desired contact from the displayed list.

 Press **"Call"**.

Calling a recently used number

 Press **Telephone** to display the main page.

Or



Press and hold



the steering mounted button.

Press "**Recent calls**".

Select the desired contact from the displayed list.

i It is always possible to make a call directly from the telephone; as a safety measure, first park the vehicle.

Setting the ringtone

Press **Telephone** to display the main page.Press the "**OPTIONS**" button to access the secondary page.Press "**Ring volume**" to display the volume bar.

Press the arrows or move the slider to set the ring volume.

Using CarPlay® or Android Auto

Synchronising a smartphone enables users to display applications that support the smartphone's CarPlay® or Android Auto technology on the vehicle's screen. For CarPlay® technology, the CarPlay® function must first be activated on the smartphone.

The smartphone can be connected via USB cable or via a wireless connection.

i Unlock the smartphone for the communication process between the smartphone and the system to work. As principles and standards are constantly changing, **we recommend keeping the smartphone's operating system up-to-date, together with the date and time on the smartphone and the system.**

i For the list of compatible smartphones, visit the Manufacturer's website in your country.

USB sockets

Depending on equipment, for more information on the USB sockets compatible with **CarPlay®** or **Android Auto** applications, refer to the "Ease of use and comfort" section.

Wireless connection

! Before using CarPlay® or Android Auto wirelessly, ensure the Wi-Fi regulatory restrictions of your geographic location are met.

If the 5 GHz Wi-Fi network frequency is not allowed in your location, select **2.4 GHz** at the first connection.

Check the Wi-Fi restrictions again when you travel to different locations and set the Wi-Fi frequency accordingly.

For more information about the 5 GHz regulatory status of each country, refer to the website of the audio system manufacturer.

CarPlay® smartphone connection

Depending on country.

USB connection

i On connecting the USB cable, the CarPlay® function deactivates the system's Bluetooth® mode. The "**CarPlay**" function requires the use of a compatible smartphone and compatible applications.



Connect the USB cable.

The smartphone charges when connected by the USB cable.

From the system, press "**Telephone**" to display the main page.Press "**CarPlay**" to display the CarPlay® interface.

i CarPlay® interface may appear automatically.

i When the USB cable is disconnected and the ignition is switched off then back on, the system will not automatically switch to Radio Media mode; the source must be changed manually.



The CarPlay® navigation can be accessed at any time by pressing the system's

Navigation button.

Wireless connection

First activate the smartphone's Bluetooth® function.



From the system, press "**Telephone**" to display the main page.

If the device has already been connected to the system via Bluetooth®, select the device settings from the list of known devices and choose CarPlay® as the wireless connection mode.

If the device has never been connected to the system before, it will have to be paired (refer to the corresponding section).

The system detects if the smartphone is compatible with CarPlay® and offers to connect to it following the pairing process.

Subsequent automatic connection of the smartphone requires activation of the Bluetooth® on your device.



As soon as the connection is established, press "**CarPlay**" to display the CarPlay® interface.



Press and hold this steering-mounted control button and say "Siri" to initiate the smartphone voice commands.

Android Auto smartphone connection

Depending on country.



On the smartphone, download the Android Auto application.



The "Android Auto" function requires the use of a compatible smartphone and applications.



The first connection of Android Auto to the system should be made by USB cable.

USB connection



Connect a USB cable.

The smartphone charges when connected by a USB cable.



From the system, press "**Telephone**" to display the main page.



Press "**Android Auto**" to start the application in the system.

Depending on the smartphone, it may be necessary to activate the "**Android Auto**" function.



During the procedure, several screen pages relating to certain features are displayed.

Accept to start and complete the connection.



When connecting a smartphone to the system, we recommend enabling Bluetooth® on the smartphone.

Wireless connection

First activate the smartphone's Bluetooth® function.



Connect a USB cable.



From the system, press "**Telephone**" to display the main page.

If the device has already been connected to the system via Bluetooth®, select the device settings from the list of known devices and choose Android Auto® as the wireless connection mode. If the device has never been connected to the system before, it will have to be paired (refer to the corresponding section).

The system detects if the smartphone is compatible with Android Auto and offers to connect to it following the pairing process.

Subsequent automatic connection of the smartphone requires activation of the Bluetooth® on your device.



As soon as the connection is established, press "**Android Auto**" to display the Android Auto interface.



Press and hold this steering-mounted control button and say "OK Google" to initiate the smartphone voice commands.

Access to the different audio sources remains available in the margin of the Android Auto display, using the touch buttons located in the upper bar.

Access to the menus for the system is possible at any time using the dedicated buttons.



There may be a pause before applications become available, depending on the quality of the network.

Applications

Viewing photos

Insert a USB memory stick in the USB port.

! To protect the system, do not use a USB hub.

The system can read folders and image files in the formats: .tiff; .gif; .jpg/jpeg; .bmp and .png.

Press **Applications** to display the main page.

Press "**Photos**".

Select a folder.

Select an image to view.

Press this button to display the details of the photo.

Press the back arrow to go back a level.

Managing messages

Press **Applications** to display the main page.

Press "SMS".

Select the "SMS" tab.

Press this button to select the display settings for messages.

 Press this button to search and select a recipient.

 Select the "Quick messages" tab.

 Press this button to select the display settings for messages.

 Press this button to write a new message.

 Press the bin alongside the selected message to delete it.

 Press this button alongside the selected message to display the secondary page.

 Press this button to edit and modify the existing text.

 Press this button to write a new message.

 Press the bin to delete the message.

Settings

Adjusting the brightness

 Press **Settings** to display the main page.

 Press **Brightness**.

 Move the slider to adjust the brightness of the screen and/or the instrument panel (depending on version).

 Press in the shaded area to confirm.

Modifying system settings

 Press **Settings** to display the main page.

 Press "**Configuration**" to access the secondary page.

 Press "**System configuration**".

Press the "**Units**" tab to change the units of distance, fuel consumption and temperature. Press the "**Factory settings**" tab to restore the initial settings.

! Returning the system to factory settings activates the English language by default (depending on version).

Press the "**System info**" tab to display the versions of the various modules installed in the system.

Press the "**Privacy**" tab,
or









 Press **Settings** to display the main page.

 Press "**Privacy**" to activate or deactivate the private data mode.





 Activate or deactivate:

- "**No sharing (data, vehicle position)**".
- "**Only data sharing**".
- "**Data and vehicle position sharing**".

 Press the back arrow to confirm.









-  Press **Settings** to display the main page.
-  Press "**Configuration**" to access the secondary page.
-  Press "**Screen configuration**".
- Press "**Brightness**".
-  Move the slider to adjust the brightness of the screen and/or the instrument panel (depending on version).
-  Press the back arrow to confirm.
- Press "**Animation**".
-  Activate or deactivate: "**Automatic scrolling**".
-  Select "**Animated transitions**".
-  Press the back arrow to confirm.

Selecting the language

-  Press **Settings** to display the main page.
-  Press "**Configuration**" to access the secondary page.
-  Select "**Language**" to change the language.
-  Press the back arrow to confirm.





Setting the time



-  Press **Settings** to display the main page.

-  Press "**Configuration**" to access the secondary page.
-  Press "**Date and time**".
- Select "**Time**".
-  Press this button to set the time using the virtual keypad.
-  Press "**OK**" to save the time.
-  Press this button to set the time zone.
-  Select the display format for the time (12h/24h).
-  Activate or deactivate summer time (+1 hour).
-  Press the back arrow to save the settings.

 The system may not automatically manage the change between winter and summer time (depending on the country of sale).



Setting the date

-  Press **Settings** to display the main page.
-  Press "**Configuration**" to access the secondary page.
-  Press "**Date and time**".
- Select "**Date**".
-  Press this button to set the date.

-  Press the back arrow to save the date.
-  Select the display format for the date.
-  Press the back arrow again to confirm.

 Time and date setting is only available if "GPS Synchronisation." is deactivated.

Wifi settings

-  Press **Settings** to display the main page.
-  Press **Wifi** to access network frequency setting.

Frequently asked questions

The following information groups together the answers to the most frequently asked questions concerning the system.

Radio

The reception quality of the tuned radio station gradually deteriorates or the station presets are not working (no sound, 87.5 MHz is displayed, etc.).

The vehicle is too far from the selected station's transmitter, or no transmitter is present in the geographical area.

▶ Activate the "RDS" function in the upper bar to enable the system to check whether there is a more powerful transmitter in the geographical area.

The environment (hills, buildings, tunnels, basement car parks, etc.) is blocking reception, including in RDS mode.

This is a perfectly normal phenomenon, and is not indicative of an audio system malfunction. The aerial is missing or has been damaged (for example while entering a car wash or underground car park).

▶ Have the aerial checked by a dealer.

I cannot find some radio stations in the list of received stations.

The name of the radio station changes.

The station is no longer received or its name has changed in the list.

▶ Press the round arrow on the "List" tab on the "Radio" page.

Some radio stations send other information in place of their name (the title of the song for example).

The system interprets these details as the station name.

▶ Press the round arrow on the "List" tab on the "Radio" page.

Media

Playback of my USB memory stick starts only after a very long wait (around 2 to 3 minutes).

Some files supplied with the memory stick may greatly slow down access to reading the memory

stick (multiplication by 10 of the cataloguing time).

▶ Delete the files supplied with the memory stick and limit the number of sub-folders in the file structure on the memory stick.

Some characters in information about the currently playing media are not displayed correctly.

The audio system is unable to process certain types of character.

▶ Use standard characters to name tracks and folders.

Playback of streaming files does not start.

The connected device does not automatically launch playback.

▶ Start playback from the device.

Track names and playing times are not displayed on the audio streaming screen.

The Bluetooth profile does not allow the transfer of this information.

Telephone

I cannot connect my Bluetooth telephone.

The telephone's Bluetooth function may be switched off or the device may not be visible.

▶ Check that the telephone has Bluetooth switched on.

▶ Check in the telephone settings that it is "visible to all".

The Bluetooth telephone is not compatible with the system.

▶ Check the compatibility of the telephone on the Brand's website (services).

Android Auto and/or CarPlay do not work.

Android Auto and CarPlay may not activate if the USB cables are of poor quality.

▶ Use genuine USB cables to ensure compatibility.

Android Auto and/or CarPlay do not work.

Android Auto and CarPlay are not available in all countries.

▶ Check the Google Android Auto or Apple website to see which countries are supported.

The volume of the telephone connected in Bluetooth mode is inaudible.

The volume depends on both the system and the telephone.

▶ Increase the volume of the audio system, to maximum if required, and increase the volume of the telephone if necessary.

Ambient noise affects the quality of the telephone call.

▶ Reduce ambient noise (close windows, turn down ventilation, slow down, etc.).

The contacts are not listed in alphabetical order.

Some telephones offer display options.

Depending on the settings chosen, contacts can be transferred in a specific order.

▶ Modify the telephone directory display settings.

Settings

When the treble and bass settings are changed, the ambience is deselected.

When the ambience is changed, the treble and bass settings are reset.

Selecting an ambience imposes the treble and bass settings, and vice versa.

- ▶ Modify the treble and bass or ambience settings to obtain the desired musical ambience.

When the balance settings are changed, the distribution is deselected.

When the distribution setting is changed, the balance settings are deselected.

Selecting a distribution setting imposes the balance settings, and vice versa.

- ▶ Modify the balance setting or the distribution setting to obtain the desired sound quality.

There is a difference in sound quality between audio sources.

To allow for optimal listening quality, the sound settings can be tailored to different audio sources, which can generate audible differences when changing source.

- ▶ Check that the sound settings are appropriate to the sources listened to. Adjust the sound functions to the middle position.

When the engine is off, the system switches off after several minutes of use.

When the engine is switched off, the system's operating time depends on the state of charge of the battery.

The switch-off is normal: the system automatically goes into energy economy mode and switches off to maintain an adequate charge in the battery.

- ▶ Start the vehicle's engine to increase the charge of the battery.

CITROËN Connect Nav

GPS navigation - Applications - Multimedia audio system - Bluetooth® telephone

 The functions and settings described vary according to the vehicle version and configuration, as well as the country of sale.

 For safety reasons and because they require sustained attention by the driver, the following operations must be carried out with the **vehicle stationary** and the ignition on:

- Pairing the smartphone with the system via Bluetooth.
- Using the smartphone.
- Connecting to the CarPlay® or Android Auto applications (certain applications stop displaying when the vehicle is moving).
- Watching a video (the video stops when the vehicle starts to move again).
- Changing the system settings and configuration.

 AM and DAB radio are not available on Hybrid vehicles.

 The system is protected so that it only operates in the vehicle.

The message **Energy economy mode** is displayed when the system is about to go into standby.

 System and map updates can be downloaded from the Brand's website.

The update procedure is also available there.

 The system's Open Source Software (OSS) source codes are available at the following addresses:

<https://www.groupe-psa.com/fr/oss/>
<https://www.groupe-psa.com/en/oss/>

First steps



With the engine running, a press mutes the sound.

With the ignition off, a press turns the system on. Increase or decrease the volume using the wheel or the "plus" or "minus" buttons (depending on the equipment).

Use the menu buttons on either side of or below the touch screen for access to the menus, then press the virtual buttons in the touch screen. Depending on the model, use the "Source" or "Menu" buttons to access the rolling menus, then press the virtual buttons in the touch screen. Display the rolling menus at any time by pressing the screen briefly with three fingers.

All of the touch areas of the screen are white. Press the back arrow to go back a level. Press "OK" to confirm.

 The touch screen is of the "capacitive" type.

To clean the screen, use a soft, non-abrasive cloth (e.g. spectacles cloth) with no additional product.

Do not use sharp objects on the screen.
Do not touch the screen with wet hands.

Certain information is displayed permanently in the side bars or in the upper bar of the touch screen (depending on equipment):

- Air conditioning status information (depending on version), and direct access to the corresponding menu.
- Go directly to the audio source selection option, to view the list of radio stations (or list of titles depending on the source).
- Go to the "Notifications" of messages, emails, map updates and, depending on the services, the navigation notifications.
- Go to the settings for the touch screen and the digital instrument panel.

Audio source selection (depending on equipment):

- FM/DAB/AM radio stations (depending on equipment).
- Telephone connected via Bluetooth and Bluetooth multimedia broadcast (streaming).
- USB memory stick.

- Media player connected via the auxiliary socket (depending on equipment).
- Video (depending on equipment).

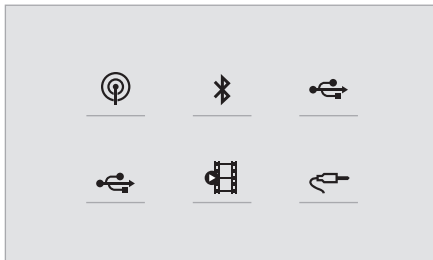

i In the "Settings" menu, it is possible to create a profile for an individual or for a group of people with shared interests, and configure a wide range of settings (radio presets, audio settings, navigation history, favourite contacts, etc.). Settings are applied automatically.

i In very hot conditions, the volume may be limited to protect the system. It may enter standby mode (with the screen and sound off) for 5 minutes or more. The system will resume normal operation when the temperature in the passenger compartment has dropped.

Steering mounted controls



Voice control:

This control is located on the steering wheel or at the end of the lighting control stalk (depending on equipment).
Short press, system voice control.
Long press, voice commands from smartphone or CarPlay®, Android Auto via the system.



Increase volume.



Decrease volume.

Mute by pressing the volume increase and decrease buttons simultaneously (depending on equipment).

Restore the sound by pressing one of the two volume buttons.



Media (short press): change the multimedia source.



Telephone (short press): start telephone call.

Call in progress (short press): access telephone menu.

Telephone (long press): reject an incoming call, end call; when no call is in progress, access telephone menu.



Radio (rotate): automatic search for the previous/next station.

Media (rotate): previous/next track, move through a list.

Short press: confirm a selection; if nothing selected, access presets.



Radio: display the list of stations.

Media: display the list of tracks.

Radio (press and hold): update the list of detected stations.

Menus

Connected navigation



Enter navigation settings and choose a destination.

Use real-time services, depending on equipment.

Applications

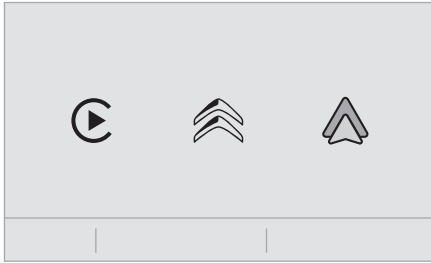

 Run certain applications from a smartphone connected via CarPlay® or Android Auto. Check the status of the Bluetooth® and Wi-Fi connections.

Radio Media

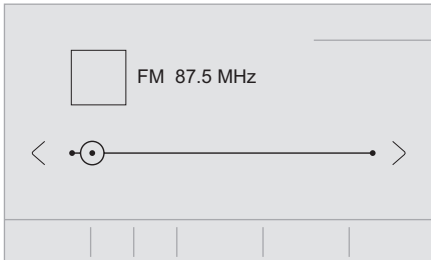

 Select an audio source or radio station, or display photographs.

Telephone

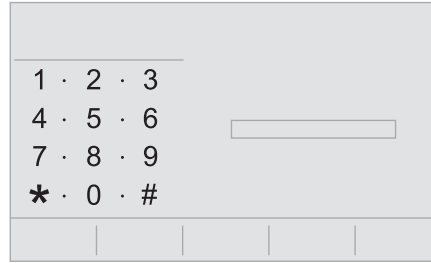

 Connect a telephone via Bluetooth®, read messages and emails and send quick messages.

Settings

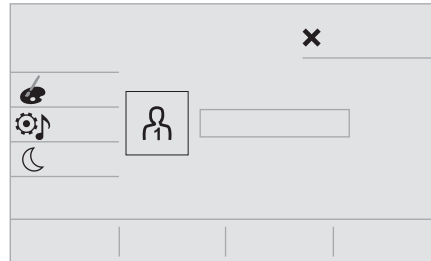

 Configure a personal profile and/or configure the sound (balance, ambience, etc.) and the display (language, units, date, time, etc.).

Vehicle



 Activate, deactivate or configure certain vehicle functions.

Air conditioning

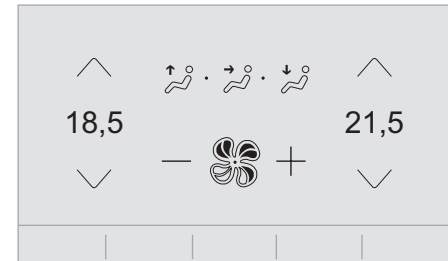

 Manage various temperature and air flow settings.

Voice commands

Steering wheel-mounted controls



Voice commands:

Voice commands can be issued from any screen page after a short press on the "Voice commands" button located on the steering wheel or at the end of the lighting control stalk (depending on equipment), as long as there is no telephone call in progress.



To ensure that voice commands are always recognised by the system, please follow these recommendations:

- **use natural language in a normal tone without breaking up words or raising your voice.**
- always wait for the "beep" (audible signal) before speaking.
- for best results, closing the windows and sunroof is recommended, to avoid extraneous interference (depending on version).
- before issuing a voice command, ask any other passengers to refrain from speaking.

First steps



Example of a "voice command" for navigation:

"Navigate to address 11 regent street, London"

Example of a "voice command" for the radio and media:

"Play artist Madonna"

Example of a "voice command" for the telephone:

"Call David Miller"



The voice commands, with a choice of 17 languages (Arabic, Brazilian, Czech, Danish, Dutch, English, Farsi, French, German, Italian, Norwegian, Polish, Portuguese, Russian, Spanish, Swedish, Turkish), are made using the language previously chosen and set in the system. For some voice commands, there are alternative synonyms.

Example: Guide to / Navigate to / Go to / ...
The voice commands in Arabic for: "Navigate to address" and "Display POI in the city", are not available.

Information - Using the system



When voice commands are activated, by briefly pressing the button, help is displayed on the touch screen, offering various menus and enabling voice-based interaction with the system.

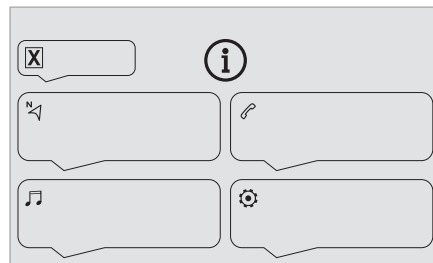

A number of commands are available when a menu is selected.

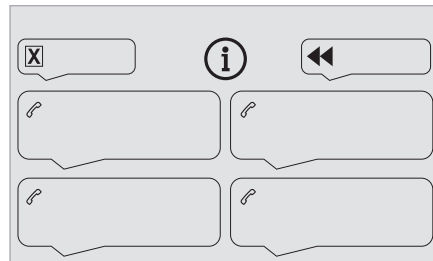

Press the Push To Talk button and tell me what you'd like after the tone. Remember you can interrupt me at any time by pressing this button. If you press it again while I'm waiting for you to speak, it'll end the conversation. If you need to start over, say "cancel". If you want to undo something, say "undo". And to get information and tips at any time, just say "help". If you ask to me do something and there's some information missing that I need, I'll give you some examples or take you through it step by

step. There's more information available in "novice" mode. You can set the dialogue mode to "expert" when you feel comfortable.

Global voice commands



Voice commands

Set dialogue mode as novice - expert
Select user 1 / Select profile John
Increase temperature
Decrease temperature



Help messages

There are lots of topics I can help you with. You can say: "help with phone", "help with navigation", "help with media" or "help with radio". For an overview on how to use voice controls, you can say "help with voice controls". Say "yes" if I got that right. Otherwise, say "no" and we'll start that again.

"Navigation" voice commands



Voice commands

Navigate home
Navigate to work
Navigate to preferred address, Tennis club
Navigate to contact, John Miller
Navigate to address 11 regent street, London



Help messages

To plan a route, say "navigate to" followed by the address, the contact name or an intersection. For example, "navigate to address 11 Regent Street, London", "navigate to contact, John Miller", or "navigate to intersection of Regent Street, London". You can specify if it's a preferred address, or a Point of Interest. For example, say "navigate to preferred address, Tennis club", or "navigate to POI Heathrow Airport in London". Or, you can just say, "navigate home". To see Points of Interest on a map, you can say things like "show POI hotels in Banbury". For more information say "help with points of interest" or "help with route guidance".

To choose a destination, say something like "navigate to line three" or "select line two". If you can't find the destination but the street's right, say for example "select the street in line three". To move around a displayed list, you can say "next page" or "previous page". You can undo your last action and start over by saying "undo", or say "cancel" to cancel the current action.



Voice commands

Tell me the remaining distance
Tell me the remaining time
Tell me the arrival time
Stop route guidance



Help messages

You can say "stop" or "resume route guidance". To get information about your current route, you can say "tell me the remaining time", "remaining

distance" or "arrival time". To learn more commands, try saying "help with navigation".



Voice commands

Show POI "hotel" at the destination
Show nearby POI petrol station
Navigate to POI Heathrow Airport in London
Navigate to POI petrol station along the route



Help messages

To see points of interest on a map, you can say things like "show hotels in Banbury", "show nearby parking", "show hotel at the destination" or "show petrol station along the route". If you prefer to navigate directly to a point of interest, you can say "navigate to nearby petrol station". If you feel you are not being well understood, try to say the word "POI" in front of the point of interest. For example say "navigate to POI restaurant at the destination".

To choose a POI, say something like "select line 2". If you've searched for a Point of Interest and don't see the one you're after, you can filter further by saying something like "select POI in line 2", or "select the city in line 3". You can also scroll through the list by saying "next page" or "previous page".

i Depending on the country, give destination (address) instructions in the language configured for the system.

"Radio Media" voice commands



Voice commands

Turn on source radio - Streaming Bluetooth
- ...



Help messages

You can select an audio source by saying "turn on source" followed by the device name. For example, "turn on source, Streaming Bluetooth", or "turn on source, radio". Use the command "play" to specify the type of music you'd like to hear. You can choose between "song", "artist", or "album". Just say something like "play artist, Madonna", "play song, Hey Jude", or "play album, Thriller".



Voice commands

Tune to channel BBC Radio 2
Tune to 98.5 FM

Tune to preset number five



Help messages

You can pick a radio station by saying "tune to" and the station name or frequency. For example "tune to channel Talksport" or "tune to 98.5 FM". To listen to a preset radio station, say for example "tune to preset number five".



Voice commands

What's playing?



Help messages

To choose what you'd like to play, start by saying "play" and then the item. For example, say "play song Hey Jude", "play line 3" or "select line 2". You can undo your last action and start over by saying "undo", or say "cancel" to cancel the current action.



Voice commands

Play song Hey Jude

Play artist Madonna

Play album Thriller



Help messages

I'm not sure what you'd like to play. Please say "play" and then a song title, an album title, or an artist name. For example, say "play song Hey Jude", "play artist Madonna" or "play album Thriller". To select a line number from the display, say "select line two". To move around a displayed list, you can say "next page" or "previous page". You can undo your last action and start over by saying "undo", or say "cancel" to cancel the current action.



Media voice commands are available only with a USB connection.

"Telephone" voice commands



If there is no telephone connected by Bluetooth, a voice message announces: "Please first connect a telephone", and the voice session is closed.



Voice commands

Call David Miller*

Call voicemail*

Display calls*



Help messages

To make a phone call, say "call" followed by the contact name, for example: "Call David Miller". You can also include the phone type, for example: "Call David Miller at home". To make a call by number, say "dial" followed by the phone number, for example, "Dial 107776 835 417". You can check your voicemail by saying "call voicemail". To send a text, say "send quick message to", followed by the contact, and then the name of the quick message you'd like to send. For example, "send quick message to

* This function is available only if the telephone connected to the system supports downloading of contacts and recent calls and the corresponding download has been performed.

David Miller, I'll be late". To display the list of calls, say "display calls". For more information on SMS, you can say "help with texting". To choose a contact, say something like "select line three". To move around the list say "next page" or "previous page". You can undo your last action and start over by saying "undo", or say "cancel" to cancel the current action.

"Text message" voice commands

If there is no telephone connected by Bluetooth, a voice message announces: "Please first connect a telephone", and the voice session is closed.

The "Text messages" voice commands function allows you to dictate and send an SMS. Dictate the text, taking care to pause briefly between each word. When you have finished, the voice recognition system will automatically generate an SMS.

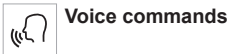

Voice commands

Send quick message to Bill Carter, I'll be late



Help messages

From the list of quick messages, say the name of the one you'd like to send. To move around the list you can say "go to start", "go to end", "next page" or "previous page". You can undo your last action and start over by saying "undo", or say "cancel" to cancel the current action.



Voice commands

Send SMS to John Miller, I'm just arriving
Send SMS to David Miller at the office, don't wait for me



Help messages

Please say "call" or "send quick message to", and then select a line from the list. To move around a list shown on the display, you can say "go to start", "go to end", "next page" or "previous page". You can undo your last action and start over by saying "undo", or say "cancel" to cancel the current action.



Voice commands

Listen to most recent message*



Help messages

To hear your last message, you can say "listen to most recent message". When you want to send a text, there's a set of quick messages ready for you to use. Just use the quick message name and say something like "send quick message to

Bill Carter, I'll be late". Check the phone menu for the names of the supported messages.

The system only sends pre-recorded "Quick messages".

Navigation

Choice of a destination

To a new destination

Intuitive method:



Press **Navigation** to display the main page.



Press **"Search..."**.



Enter an address or the key words for the destination.



Press **"OK"** to select the **"Guidance criteria"**.

Or

Guided method:

In order to be able to use the navigation, you must enter the **"City"**, the **"Street"** (suggestions are displayed automatically when you begin typing), then enter the **"Number"** using the virtual keypad, or select

* This function is available only if the telephone connected to the system supports downloading of contacts and recent calls and the corresponding download has been performed.

an address from the **"Contact"** list or the address **"History"**.

i If you do not confirm the number, the navigation system will show one end of the street.

Press the **"MENU"** button to access the secondary page.



Select **"Enter address"**.

Then



Select the **"Country"**.



Select the keyboard "language".



Change the keyboard "type" according to the selected "language": ABCDE;

AZERTY; QWERTY or QWERTZ.



Enter the **"City"**, the **"Street"** and the **"Number"**, and confirm by pressing on the displayed suggestions.



Press **"OK"** to select the **"Guidance criteria"**.

And/or



Select **"See on map"** to choose the **"Guidance criteria"**.



Press **"OK"** to start guided navigation.

i Zoom in/out using the touch buttons or with two fingers on the screen.

To a recent destination



Press **Navigation** to display the main page.

Press the **"MENU"** button to access the secondary page.



Select **"My destinations"**.

Select the **"Recent"** tab.

Select the address chosen in the list to display the **"Guidance criteria"**.



Press **"OK"** to start guided navigation.

i Select **"Position"** to see the point of arrival on the map.

To "Home" or "My work"



Press **Navigation** to display the main page.

Press the **"MENU"** button to access the secondary page.



Select **"My destinations"**.

Select the **"Preferred"** tab.



Select **"Home"**.

Or



Select **"My work"**.

Or

Select a preset favourite destination.

To a contact



Press **Navigation** to display the main page.

Press the **"MENU"** button to access the secondary page.



Select **"My destinations"**.

Select the **"Contact"** tab.

Select a contact in the list to start guided navigation.

To points of interest (POI)

Guided method:

Points of interest (POI) are listed in different categories.



Press **Navigation** to display the main page.

Press the **"MENU"** button to access the secondary page.



Select **"Points of interest"**.



Select the **"Travel"**, **"Leisure"**, **"Commercial"**, **"Public"** or **"Geographic"**

tab.

Or



Select **"Search"** to enter the name and address of a POI.



Press **"OK"** to calculate the route.

Or

Intuitive method:

i You can only select this method of using the service if a network connection is active; this may be either a "network connection provided by the vehicle", if you use the Citroën Connect Box solution, or else a "network connection provided by the user" via a smartphone. In both cases, the system is automatically connected to the Internet, if network coverage permits.

 Press **Navigation** to display the main page.

Press the **"MENU"** button to access the secondary page.

 Select **"Search"**.

Press on the mode shown in the bottom right of the screen (On-Board or Connected) to change the "Database".

 Select the "Database" in "On-Board" mode (integrated into the map), or in

"Connected" mode (connected to the Internet).

 Press the back arrow to confirm.

 Enter an address or the key words for the destination (POI).

 Press **"OK"** to start the search.

 Select the **"On the route"**, **"Around the vehicle"** or **"At destination"** tab to refine your search.

Select the desired address to calculate the route.

To a point on the map

 Press **Navigation** to display the main page.

Explore the map by sliding a finger on the screen.

Select the destination by pressing on the map.

 Tap the screen to place a marker and display the sub-menu.

 Press this button to start guided navigation.

Or

 Press this button to save the displayed address.

i A long press on a point opens a list of nearby POIs.

To GPS coordinates

 Press **Navigation** to display the main page.

Explore the map by sliding a finger on the screen.

Touch the screen with a finger to go to the next image.

 Press this button to display the world map.

Using the grid, select the desired country or region by zooming.

 Press this button to display or enter the GPS coordinates.



A marker is displayed in the middle of the screen, with the **"Latitude"** and **"Longitude"** coordinates.

Choose the type of coordinates:
DMS for: Degrees, Minutes, Seconds.
DD for: Degrees, Decimals.



Press this button to start guided navigation.

Or



Press this button to save the displayed address.

OR



Press this button to enter the **"Latitude"** value using the virtual keypad.

And



Press this button to enter the **"Longitude"** value using the virtual keypad.

TMC (Traffic Message Channel)

Available in some countries.

TMC (Traffic Message Channel) messages are based on a European standard for traffic information broadcasting via the RDS system on FM radio, sending traffic information in real time. The TMC information is then displayed on a GPS Navigation system map and taken into account straight away when routes are calculated, to avoid accidents, traffic jams and closed roads.

i Danger zone alerts may or may not be displayed, depending on the applicable

legislation and subscription to the corresponding service.

Connected navigation

Connected navigation connection

Depending on version, vehicle trim level and subscription to online services and options.

Network connection provided by the vehicle



With the Citroën Connect Box solution, the system is automatically connected to the Internet and connected services, and does not require the user to provide a connection via their smartphone.

OR

Network connection provided by the user



For the list of compatible smartphones, visit the Brand's website in your country.

Activate and enter settings for sharing the smartphone connection.

As processes and standards are constantly changing, we recommend you

update the smartphone operating system as well as the date and time on the smartphone and system, to ensure that the communication process between the smartphone and the system functions correctly.

USB connection



Connect the USB cable. The smartphone charges when connected by the USB cable.

Bluetooth connection



Activate the Bluetooth function on the telephone and ensure that it is visible to all (see the "Connect-App" section).

Wi-Fi connection



Select a Wi-Fi network detected by the system and connect to it.

This function is only available if it has been activated either via the "Notifications" or via the "Applications" menu.



Press "**Notifications**".



Select Wi-Fi to activate it.

OR



Press **Connect-App** to display the main page.

Press the "**OPTIONS**" button to access the secondary page.



Select "**Wi-Fi network connection**".



Select the "**Secured**", "**Not secured**" or "**Stored**" tab.



Select a network.



Using the virtual keypad, enter the "**Key**" network Wi-Fi and the "**Password**".



Press "**OK**" to establish a connection between the smartphone and the

vehicle's system.

Usage restrictions:
With CarPlay®, connection sharing is only available with a Wi-Fi connection. The quality of services depends on the quality of the network connection.

Authorize sending information



Press **Settings** to display the main page.

Press the "**OPTIONS**" button to access the secondary page.



Select "**System configuration**".



Select the "**Private mode**" tab.

OR



Press "**Notifications**".



Press "**Private mode**".

THEN

 Activate or deactivate:

- "No data sharing except for company vehicles".
- "Only data sharing"
- "Sharing data and vehicle position"

Settings specific to connected navigation

 Press **Navigation** to display the main page.

Press the **"MENU"** button to access the secondary page.

 Select **"Settings"**.

 Select the **"Map"** tab.

 Activate or deactivate:

- **"Allow declaration of danger zones"**.
 - **"Guidance to final destination on foot"**.
- These settings must be configured for each profile.

 Press **"OK"** to confirm your selection.

 Select the **"Alerts"** tab.

 Activate or deactivate:

- **"Advise of car park nearby"**.
- **"Filling station alert"**.
- **"Risk areas alert"** then press the warning icon (triangle) to configure the alerts.

- **"Give an audible warning"**.
- **"Advise proximity of POI 1"**.
- **"Advise proximity of POI 2"**.

 Press **"OK"** to confirm your selection.

 The "Notifications", located in the upper bar, can be accessed at any time.

 Danger zone alerts may or may not be displayed, depending on the applicable legislation and subscription to the corresponding service.

 When "TOMTOM TRAFFIC" appears, the services are available.

 The services offered with connected navigation are as follows.

A Connected Services pack:

- Weather,
- Filling stations,
- Car park,
- Traffic,
- POI local search.

A Danger area pack (optional).

Declaration: "Risk areas alert"

 To send information about danger zones, select the option: **Allow declaration of danger zones**

 Press **Navigation** to display the main page.

 Press the **"Declare a new danger zone"** button located in the side bars or the upper bar of the touch screen (depending on equipment).

 Select the **"Type"** option to select the type of "Danger area".

 Select the **"Speed"** option and enter it using the virtual keypad.

 Press **"OK"** to save and send the information.

Displaying fuel information

 Press **Navigation** to display the main page.

 Press this button to display the list of services.

 Press **"POI on map" to display the list of points of interest.**

 Press one of the buttons to search for **"Stations"**.

 Activate/deactivate **"Stations"**.









 Press this button to display a secondary page.

 Select the **"Settings"** tab.





 Select the desired fuel.



 Press **"OK"** to save.

Displaying charging station details

-  Press **Navigation** to display the main page.
-  Press this button to display the list of services.
-  Press **"POI on map"** to display the list of points of interest.
-  Press one of the buttons to search for **"Stations"**.
-  Activate/deactivate **"Stations"**.
-  Press this button to display a secondary page.
-  Select the **"Settings"** tab.
-  Select the desired connector type.
-  Press **"OK"** to save.

Displaying weather information

-  Press **Navigation** to display the main page.
-  Press this button to display the list of services.
-  Select **"View map"**.
-  Select **"Weather"**.

-  Press this button to display basic information.
-  Press this button to display detailed weather information.

 The temperature displayed at 6 a.m. will be the maximum temperature for the day. The temperature displayed at 6 p.m. will be the minimum temperature for the night.

Applications

USB sockets

Depending on equipment, for more information on the USB sockets compatible with **CarPlay®** or **Android Auto** applications, refer to the "Ease of use and comfort" section.

 For the list of compatible smartphones, visit the Manufacturer's website in your country.

 Synchronising a smartphone enables users to display applications that support the smartphone's CarPlay® or Android Auto technology on the vehicle's screen. For CarPlay® technology, the CarPlay® function must first be activated on the smartphone. Unlock the smartphone for the communication process between the smartphone and the system to work.

As principles and standards are constantly changing, **we recommend keeping the smartphone's operating system up-to-date, together with the date and time on the smartphone and the system.**

Connectivity

 Press **Applications** to display the main page.

Press **"Connectivity"** to access the **CarPlay®** or **Android Auto** functions.

CarPlay® smartphone connection

Depending on country.

 On connecting the USB cable, the CarPlay® function deactivates the system's Bluetooth® mode. The **"CarPlay"** function requires the use of a compatible smartphone and compatible applications.

 Connect the USB cable. The smartphone charges when connected by the USB cable.

 Press **"Telephone"** to display the CarPlay® interface.

Or

 Connect the USB cable. The smartphone charges when connected by the USB cable.

From the system, press "**Applications**" to display the main page.

Press "**Connectivity**" to access the "CarPlay®" function.



Press "**CarPlay**" to display the CarPlay® interface.

i When the USB cable is disconnected and the ignition is switched off then back on, the system will not automatically switch to Radio Media mode; the source must be changed manually.

Android Auto smartphone connection

Depending on country.

i Install the "**Android Auto**" application on the smartphone via "Google Play".

The "**Android Auto**" function requires the use of a compatible smartphone and compatible applications.



Connect the USB cable. The smartphone charges when connected by the USB cable.



From the system, press "**Applications**" to display the main page.

Press "**Connectivity**" to access the "Android Auto" function.



Press "**Android Auto**" to start the application in the system.

OK

During the procedure, several screen pages relating to certain features are displayed.

Accept to start and complete the connection.

Access to the different audio sources remains available in the margin of the Android Auto display, using the touch buttons located in the upper bar.

Access to the menus for the system is possible at any time using the dedicated buttons.



i In Android Auto mode, the function that displays rolling menus by briefly pressing the screen with three fingers is disabled.



i There may be a pause before applications become available, depending on the quality of the network.

Car Apps



Press **Applications** to display the main page.

Press "**Car Apps**" to display the applications home page.

Internet Browser



Press **Applications** to display the main page.

Press "**Connectivity**" to access the "**Connected Apps**" function.

Press "**Connected Apps**" to display the browser home page.



Select the country of residence.

OK

Press "**OK**" to save and start the browser.



i Connection to the internet is via one of the network connections provided by the vehicle or the user.

Bluetooth connection®



! The services available depend on the network, the SIM card and the compatibility of the Bluetooth devices used. Consult the smartphone user guide and the service provider to check which services are available.



i The Bluetooth function must be activated and the smartphone configured as "Visible to all".

To complete the pairing, whichever procedure is used (from the smartphone or from the system), ensure that the code is the same in the system and in the smartphone.



i If the pairing procedure fails, we recommend deactivating and then reactivating the Bluetooth function on the smartphone.

Procedure from the smartphone



Select the name of the system in the list of detected devices.

In the system, accept the connection request from the smartphone.

Procedure from the system



Press **Connect-App** to display the main page.

Press the **"OPTIONS"** button to access the secondary page.



Press **"Bluetooth connection"**.



Select **"Search"**.

The list of detected smartphones is displayed.



Select the name of the chosen smartphone in the list.



Depending on the type of smartphone, you may be prompted to accept the transfer of contacts and messages.

Connection sharing

The system offers to connect the smartphone with 3 profiles:

- **"Telephone"** (hands-free kit, telephone only),
- **"Streaming"** (streaming: wireless playing of audio files on the smartphone),
- **"Mobile internet data"**.



The **"Mobile internet data"** profile must be activated for connected navigation (if

the vehicle does not have "Emergency and assistance call" services), after first activating smartphone connection sharing.



Select one or more profiles.

OK

Press **"OK"** to confirm.

Wi-Fi connection

Network connection via the smartphone's Wi-Fi.



Press **Connect-App** to display the main page.



Press the **"OPTIONS"** button to access the secondary page.



Select **"Wi-Fi network connection"**.



Select the **"Secured"**, **"Not secured"** or **"Stored"** tab.



Select a network.



Using the virtual keypad, enter the Wi-Fi network **"Key"** and **"Password"**.

OK

Press **"OK"** to establish the connection.



The Wi-Fi connection and Wi-Fi connection sharing are exclusive.

Wi-Fi connection sharing

Depending on equipment.

Creation of a local Wi-Fi network by the system.



Press **Connect-App** to display the main page.

Press the **"OPTIONS"** button to access the secondary page.



Select **"Share Wi-Fi connection"**.

Select the **"Activation"** tab to activate or deactivate Wi-Fi connection sharing.

And/or

Select the **"Settings"** tab to change the system's network name and password.

OK

Press **"OK"** to confirm.



To protect against unauthorised access and to make all systems as secure as possible, the use of a security code or a complex password is recommended.

Managing connections



Press **Connect-App** to display the main page.

Press the **"OPTIONS"** button to access the secondary page.



Select **"Manage connection"**.

With this function, you can view the access to connected services, the availability of connected services and modify the connection mode.

Radio

Selecting a station



Press **Radio Media** to display the main page.

Press "**Frequency**".



Press one of the buttons to perform an automatic search for radio stations.

Or



Move the slider to manually search for frequencies up or down.

Or



Press **Radio Media** to display the main page.

Press the "**OPTIONS**" button to access the secondary page.



Select "**Radio stations**" on the secondary page.

Press "**Frequency**".



Enter the values using the virtual keypad. First enter the units then click on the decimals field to enter the figures after the decimal point.

OK

Press "**OK**" to confirm.

! Radio reception may be affected by the use of electrical equipment not approved by the Brand, such as a USB charger connected to the 12 V socket. The exterior environment (hills, buildings, tunnels, basement car parks, etc.) may block reception, including in RDS mode.

This phenomenon is perfectly normal in the context of radio wave transmission, and in no way indicative of an audio system malfunction.

Presetting a station

Select a radio station or frequency. (refer to the corresponding section)
Press "**Presets**".



Make a long press on one of the buttons to preset the station.

Changing the waveband



Press **Radio Media** to display the main page.

To change the waveband, press "Band...", displayed at the top right of the screen.

Activating/Deactivating RDS

RDS, if activated, allows you to continue listening to the same station by automatic retuning to alternative frequencies.



Press **Radio Media** to display the main page.

Press the "**OPTIONS**" button to access the secondary page.



Select "**Radio settings**".

Select "**General**".



Activate/deactivate "**Station follow**".

OK

Press "**OK**" to confirm.



RDS station tracking may not be available nationwide, as many radio stations do not cover 100 % of the country. This explains the loss of reception of the station during a journey.

Displaying text information

The "Radio Text" function displays information transmitted by the radio station relating to the station or the currently playing song.



Press **Radio Media** to display the main page.

Press the "**OPTIONS**" button to access the secondary page.



Select "**Radio settings**".

Select "**General**".



Activate/deactivate "**Display radio text**".

OK

Press "**OK**" to confirm.

Playing TA messages

The TA (Traffic Announcement) function gives priority to TA alert messages. To operate, this function needs good reception of a radio station that carries this type of message. While traffic information is being broadcast, the current media is automatically interrupted so that the

TA message can be heard. Normal play of the previously playing media resumes at the end of the message.

Select **"Announcements"**.

Activate/deactivate **"Traffic announcement"**.

OK Press **"OK"** to confirm.

DAB (Digital Audio Broadcasting) radio

Terrestrial Digital Radio

Digital radio provides higher quality sound.

The various "multiplexes/ensembles" offer a choice of radio stations organised in alphabetical order.

 Press **Radio Media** to display the main page.

Press "Band ..." at the top right of the screen to display the **"DAB"** waveband.

FM-DAB tracking

"DAB" does not cover 100 % of the territory.

When the digital radio signal is poor, "FM-DAB auto follow-up" enables you to continue listening to the same station by automatically switching to the corresponding FM analogue station (if there is one).

 Press **Radio Media** to display the main page.

Press the **"OPTIONS"** button to access the secondary page.

 Select **"Radio settings"**.

Select **"General"**.

Activate/deactivate **"FM-DAB Follow-up"**.

Activate/deactivate **"Station follow"**.

OK Press **"OK"**.

 If "FM-DAB auto tracking" is activated, there may be a time offset of a few seconds when the system switches to "FM" analogue radio, and in some cases a change in volume.

When the digital signal quality is restored, the system automatically changes back to "DAB".

 If the "DAB" station being listened to is not available on "FM" ("FM-DAB" option shaded), or "FM-DAB auto tracking" is not activated, the sound will cut out while the digital signal is too weak.

Media

USB port

 Insert the USB memory stick into the USB port or connect the USB device to the USB port using a suitable cable (not supplied).

 To protect the system, do not use a USB hub.

The system builds playlists (in temporary memory); this operation can take from a few seconds to several minutes at the first connection.

Reduce the number of non-music files and the number of folders to reduce the waiting time. Playlists are updated whenever the ignition is switched off or a USB memory stick is connected. The audio system memorises these lists, which will subsequently load faster if they have not been changed.

Auxiliary socket (AUX)

Depending on equipment

 Connect a portable device (MP3 player, etc.) to the auxiliary jack socket using an audio cable (not supplied).

This source is only available if "Auxiliary input" has been selected in the audio settings.

First adjust the volume on the portable device (to a high level). Then adjust the volume of the audio system.

Controls are managed via the portable device.

Selecting the source



Press **Radio Media** to display the main page.

Select "**SOURCES**".

Select the source.

Watching a video

Depending on equipment/Depending on version/
Depending on country.

Insert a USB memory stick in the USB port.



Video control commands are accessible only through the touch screen.



Press **Radio Media** to display the main page.

Select "**SOURCES**".



Select **Video** to start the video.



To remove the USB memory stick, press the pause button to stop the video, then remove the memory stick.

The system can play video files in the MPEG-4 Part 2, MPEG-2, MPEG-1, H.264, H.263, VP8, WMV and RealVideo formats.

Streaming Bluetooth®

Streaming allows you to listen to the audio feed from your smartphone.

The Bluetooth profile must be activated.

First adjust the volume on the portable device (to a high level).

Then adjust the volume of the audio system.

If play does not start automatically, it may be necessary to start the audio playback from the smartphone.

Control is from the portable device or by using the system's touch buttons.



Once connected in streaming mode, the smartphone is considered to be a media source.

Connecting Apple® players

Connect the Apple® player to the USB port using a suitable cable (not supplied).

Play starts automatically.

Control is via the audio system.



The classifications available are those of the portable device connected (artists/albums/genres/playlists/audio books/podcasts).

The default classification used is by artist. To modify the classification used, return to the first level of the menu then select the desired classification (playlists for example) and confirm to go down through the menu to the desired track.

The version of software in the audio system may not be compatible with the generation of the Apple® player.

Information and advice

The system supports USB mass storage devices, BlackBerry® devices and Apple® players via the USB ports. The adapter cable is not supplied.

Devices are managed using the audio system controls.

Other devices, not recognised on connection, must be connected to the auxiliary socket using a jack cable (not supplied) or via Bluetooth streaming, if compatible.

The audio system will only play audio files with ".wma", ".aac", ".flac", ".ogg" and ".mp3" file extensions, at bit rates between 32 Kbps and 320 Kbps.

It also supports VBR (Variable Bit Rate) mode. No other file types (".mp4", etc.) can be read. All ".wma" files must be standard WMA 9 files. The supported sampling rates are 32, 44 and 48 KHz.

To avoid reading and display problems, we recommend choosing file names less than 20 characters long that do not contain any special characters (e.g. " ? ; ù).

Use only USB memory sticks in FAT32 format (File Allocation Table).



We recommend using the original USB cable for the portable device.

Telephone

Pairing a Bluetooth® telephone

! The services available depend on the network, the SIM card and the compatibility of the Bluetooth devices used. Consult the telephone user guide and the service provider to check which services are available.

i The Bluetooth function must be activated and the telephone configured as "Visible to all" (in the telephone settings).

To complete the pairing, whichever procedure is used (from the telephone or from the system), ensure that the code is the same in the system and in the telephone.

i If the pairing procedure fails, we recommend deactivating and then reactivating the Bluetooth function on the telephone.

Procedure from the telephone

 Select the system name in the list of detected devices.

In the system, accept the connection request from the telephone.

Procedure from the system



Press **Telephone** to display the main page.



Press **"Bluetooth search"**.

Or



Select **"Search"**.

The list of detected telephones is displayed.



Select the name of the chosen telephone in the list.

Connection sharing

The system offers to connect the telephone with 3 profiles:

- **"Telephone"** (hands-free kit, telephone only),
- **"Streaming"** (streaming: wireless playing of audio files on the telephone),
- **"Mobile internet data"**.

i The **"Mobile internet data"** profile must be activated for connected navigation, after first activating smartphone connection sharing.



Select one or more profiles.



Press **"OK"** to confirm.

Depending on the type of telephone, you may be prompted to accept the transfer of contacts and messages.

i The ability of the system to connect just one profile depends on the telephone. All three profiles may connect by default.

i The profiles compatible with the system are: HFP, OPP, PBAP, A2DP, AVRCP, MAP and PAN.

Visit the Brand's website for more information (compatibility, additional help, etc.).

Automatic reconnection

On returning to the vehicle, if the last telephone connected is present again, it is automatically recognised and within about 30 seconds after switching on the ignition, the pairing is established automatically (Bluetooth activated).

To modify the connection profile:



Press **Telephone** to display the main page.

Press the **"OPTIONS"** button to access the secondary page.



Select **"Bluetooth connection"** to display the list of paired devices.



Press the **"Details"** button.



Select one or more profiles.



Press **"OK"** to confirm.

Managing paired telephones

This function lets you connect or disconnect a device or delete a pairing.

 Press **Telephone** to display the main page.

Press the "**OPTIONS**" button to access the secondary page.

 Select "**Bluetooth connection**" to display the list of paired devices.

 Press on the name of the telephone selected in the list to disconnect it.

Press again to connect it.

Deleting a telephone

 Select the basket at top right of the screen to display a basket alongside the telephone chosen.

 Press the basket alongside the telephone chosen to delete it.

Receiving a call

An incoming call is announced by a ring and a superimposed display in the screen.

 Make a short press on the steering mounted telephone button to accept an incoming call.

And

 Make a long press

 on the steering mounted telephone button to reject the call.

Or



Select "**End call**" on the touch screen.

Making a call

 Using the telephone is not recommended while driving.

Park the vehicle.

Make the call using the steering mounted controls.

Calling a new number



Press **Telephone** to display the main page.



Enter the phone number using the digital keypad.



Press "**Call**" to start the call.

Calling a contact



Press **Telephone** to display the main page.



Or press and hold



the steering mounted telephone button.

Select "**Contact**".

Select the desired contact from the displayed list.



Select "**Call**".

Calling a recently used number



Press **Telephone** to display the main page.

Or



Press and hold



the steering mounted telephone button.

Select "**Calls**".

Select the desired contact from the displayed list.



It is always possible to make a call directly from the telephone; as a safety measure, first park the vehicle.

Managing contacts/entries



Press **Telephone** to display the main page.

Select "**Contact**".



Select "**Create**" to add a new contact.



Press the "**Telephone**" tab to enter the contact's telephone number(s).



Press the "**Address**" tab to enter the contact's address(es).



Press the "**Email**" tab to enter the contact's email address(es).



Press "**OK**" to save.



Press this button to sort contacts by Surname+first name or by First name+surname.

i The "**Email**" function allows email addresses to be entered for a contact, but the system is not able to send emails.

Managing messages



Press **Telephone** to display the main page.

Press the "**OPTIONS**" button to access the secondary page.



Select "**Messages**" to display the list of messages.



Select the "**All**", "**Incoming**" or "**Sent**" tab.



Select the details of the message chosen in one of the lists.



Press "**Answer**" to send a quick message stored in the system.



Press "**Call**" to start the call.



Press "**Play**" to listen to the message.

! Access to "**Messages**" depends on the compatibility between the smartphone and the onboard system. Some smartphones retrieve messages or email messages more slowly than others.

Managing quick messages



Press **Telephone** to display the main page.

Press the "**OPTIONS**" button to access the secondary page.



Select "**Quick messages**" to display the list of messages.



Select the "**Delayed**", "**My arrival**", "**Not available**" or "**Other**" tab, enabling you to create new messages.



Press "**Create**" to write a new message.



Select the message chosen in one of the lists.



Press "**Transfer**" to select one or more recipients.



Press "**Play**" to start playing the message.

Managing email



Press **Telephone** to display the main page.

Press the "**OPTIONS**" button to access the secondary page.



Select "**Email**" to display the list of messages.



Select the "**Incoming**", "**Sent**" or "**Not read**" tab.

Select the message chosen in one of the lists.



Press "**Play**" to start playing the message.

! Access to email messages depends on the compatibility between the smartphone and the onboard system.

Settings

Audio settings



Press **Settings** to display the main page.



Select "**Audio settings**".

Then select "**Ambience**", "**Position**"; "**Sound**", "**Voice**" or "**Ringtone**".



Press "**OK**" to save the settings.

i The balance/distribution (or spatialisation with the Arkamys® system) uses audio processing to adjust the sound quality according to the number of passengers in the vehicle. Available only with the front and rear speaker configuration.

i The **Ambience** setting (choice of 6 ambiances) and the **Bass**, **Medium** and **Treble** sound settings are different and independent for each audio source. Activate or deactivate "**Loudness**".

The "**Position**" settings (All passengers, Driver and Front only) are common to all sources.

Activate or deactivate "**Touch tones**", "**Volume linked to speed**" and "**Auxiliary input**".

 Onboard audio: Arkamys Sound Staging® optimises the sound distribution inside the passenger compartment.

Configuring profiles



Press **Settings** to display the main page.

Press the "**OPTIONS**" button to access the secondary page.



Select "**Setting of the profiles**".

Select "**Profile 1**", "**Profile 2**", "**Profile 3**" or "**Common profile**".



Press this button to enter a name for the profile using the virtual keypad.

OK

Press "**OK**" to confirm.



Press this button to add a photograph to the profile.



Insert a USB memory stick containing the photograph in the USB port.

Select the photograph.

OK

Press "**OK**" to accept the transfer of the photograph.

OK

Press "**OK**" again to save the settings.



The location for the photograph is square; the system reshapes the original photograph if in another format.



Press this button to reset the selected profile.



Resetting the selected profile activates the English language by default.

Select a "**Profile**" (1 or 2 or 3) to link "**Audio settings**" with it.



Select "**Audio settings**".

Then select "**Ambience**", "**Position**"; "**Sound**", "**Voice**" or "**Ringtone**".



Press "**OK**" to save the selected profile's settings.

Modifying system settings



Press **Settings** to display the main page.

Press the "**OPTIONS**" button to access the secondary page.



Select "**Screen configuration**".

Select "**Animation**".



Activate or deactivate: **Automatic scrolling**

Select "**Brightness**".



Move the slider to adjust the brightness of the screen and/or the instrument panel.



Press **Settings** to display the main page.

Press the "**OPTIONS**" button to access the secondary page.



Select "**System settings**".

Select "**Units**" to change the units of distance, fuel consumption and temperature.

Select "**Factory settings**" to restore the initial settings.



Resetting the system to "Factory settings" activates English and degrees Fahrenheit and deactivates summer time.

Select "**System info**" to display the versions of the various modules installed in the system.

Selecting the language



Press **Settings** to display the main page.

Press the "**OPTIONS**" button to access the secondary page.



Select "**Languages**" to change the language.

Setting the date



Press **Settings** to display the main page.

Press the "**OPTIONS**" button to access the secondary page.



Select "**Setting the time-date**".

Select "**Date**".



Press this button to set the date.

OK

Press "**OK**" to confirm.



Select the display format for the date.



Time and date setting is only available if "GPS synchronisation" is deactivated.

Setting the time



Press **Settings** to display the main page.

Press the "**OPTIONS**" button to access the secondary page.



Select "**Setting the time-date**".

Select "**Time**".



Press this button to set the time using the virtual keypad.

OK

Press "**OK**" to confirm.



Press this button to set the time zone.



Select the display format for the time (12h/24h).



Activate or deactivate summer time (+1 hour).



Activate or deactivate GPS synchronisation (UTC).

OK

Press "**OK**" to confirm.



The system may not automatically manage the change between winter and summer time (depending on the country of sale).

Colour schemes

Depending on equipment/Depending on version.



As a safety measure, the procedure for changing the colour scheme is only possible when the **vehicle is stationary**.



Press **Settings** to display the main page.



Select "**Color schemes**".



Select a colour scheme in the list then press "**OK**" to confirm.



Whenever the colour scheme is changed, the system restarts, temporarily displaying a black screen.

Frequently asked questions

The following information groups together the answers to the most frequently asked questions concerning the system.

Navigation

I cannot enter the navigation address.

The address is not recognised.

► Use the "intuitive method" by pressing the "Search..." button at the bottom of the "Navigation" page.

The route calculation is not successful.

The route settings may conflict with the current location (for example, if toll roads are excluded but the vehicle is on a toll road).

► Check the route settings in the "Navigation" menu.

I do not receive "Danger zone" alerts.

You have not subscribed to the online services option.

► If you have subscribed to the option:

- a few days may elapse before the service is activated,
- services may not be selected in the system menu,
- online services are not active ("TOMTOM TRAFFIC" not shown on the map).

The POIs do not appear.

The POIs have not been selected.

► Set the zoom level to 600 ft (200 m) or select POIs in the POI list.

The "Danger zone" audible warning feature is not working.

The audible warning is not active or the volume is too low.

► Activate the audible warning in the "Navigation" menu and check the voice volume in the sound settings.

The system does not suggest a detour around an incident on the route.

The route settings do not take account of TMC messages.

► Configure the "Traffic info" function in the route settings list (Without, Manual or Automatic).

I receive a warning about a "Danger area" that is not on my route.

As well as providing guided navigation, the system announces all "Danger areas" positioned in a cone located in front of the vehicle. It may provide an alert for "Danger areas" located on nearby or parallel roads.

► Zoom the map to show the exact location of the "Danger area". You can select "On the route" to stop receiving warnings or decrease the warning duration.

Certain traffic jams along the route are not indicated in real time.

On starting, a few minutes may elapse before the system begins to receive traffic information.

► Wait until traffic information is being received correctly (traffic information icons shown on the map).

In certain countries, only major routes (motorways, etc.) are listed for the traffic information.

This is perfectly normal. The system is dependent on the traffic information available.

The altitude is not displayed.

On starting, GPS initialisation may take up to 3 minutes to receive more than 4 satellites correctly.

► Wait until the system has started up completely so that there is GPS coverage by at least 4 satellites.

Depending on the geographical environment (tunnel, etc.) or the weather, the conditions of reception of the GPS signal may vary.

This behaviour is normal. The system is dependent on the GPS signal reception conditions.

My navigation is no longer connected.

During start-up and in certain geographical areas, the connection may be unavailable.

► Check that the online services are activated (settings, contract).

Radio

The reception quality of the tuned radio station gradually deteriorates or the station presets are not working (no sound, 87.5 MHz is displayed, etc.).

The vehicle is too far from the selected station's transmitter, or no transmitter is present in the geographical area.

► Activate the "RDS" function by means of the short-cut menu to enable the system to check whether there is a more powerful transmitter in the geographical area.

The aerial is missing or has been damaged (for example while entering a car wash or underground car park).

► Have the aerial checked by a dealer.

The environment (hills, buildings, tunnels, basement car parks, etc.) is blocking reception, including in RDS mode.

This is a perfectly normal phenomenon, and is not indicative of an audio system malfunction.

I cannot find some radio stations in the list of stations received.

The name of the radio station changes.

The station is no longer received or its name has changed in the list.

Some radio stations send other information in place of their name (the title of the song for example).

The system interprets these details as the station name.

► Press the "Update list" button in the "Radio stations" secondary menu.

Media

Playback of my USB memory stick starts only after a very long wait (around 2 to 3 minutes).

Some files supplied with the memory stick may greatly slow down access to reading the memory stick (multiplication by 10 of the cataloguing time).

► Delete the files supplied with the memory stick and limit the number of sub-folders in the file structure on the memory stick.

There may be an extended pause after inserting a USB stick.

The system reads a variety of data (folder, title, artist, etc.). This can take from a few seconds to a few minutes.

This is perfectly normal.

Some characters in information about the currently playing media may not be displayed correctly.

The audio system is unable to process certain types of character.

- ▶ Use standard characters to name tracks and folders.

Playback of streaming files does not start.

The connected device does not automatically launch playback.

- ▶ Start playback from the device.

Track names and playing times are not displayed on the audio streaming screen.

The Bluetooth profile does not allow the transfer of this information.

Telephone

I cannot connect my Bluetooth telephone.

The telephone's Bluetooth function may be switched off or the device may not be visible.

- ▶ Check that the telephone has Bluetooth switched on.
- ▶ Check in the telephone settings that it is "visible to all".
- ▶ Deactivate then reactivate the telephone's Bluetooth function.

The Bluetooth telephone is not compatible with the system.

- ▶ You can check the compatibility of the telephone on the Brand's website (services).

Android Auto and/or CarPlay do not work.

Android Auto and CarPlay may not activate if the USB cables are of poor quality.

- ▶ Use genuine USB cables to ensure compatibility.

Android Auto and/or CarPlay do not work.

Android Auto and CarPlay are not available in all countries.

- ▶ Check the Google Android Auto or Apple website to see which countries are supported.

The volume of the telephone connected in Bluetooth mode is inaudible.

The volume depends on both the system and the telephone.

- ▶ Increase the volume of the audio system, to maximum if required, and increase the volume of the telephone if necessary.

Ambient noise affects the quality of the telephone call.

- ▶ Reduce the ambient noise level (close windows, turn down ventilation, slow down, etc.).

Some contacts are duplicated in the list.

The options for synchronising contacts are: synchronise the contacts on the SIM card, the contacts on the telephone, or both. When both synchronisations are selected, some contacts may be duplicated.

- ▶ Select "Display SIM card contacts" or "Display telephone contacts".

The contacts are not listed in alphabetical order.

Some telephones offer display options. Depending on the settings chosen, contacts can be transferred in a specific order.

- ▶ Modify the telephone directory display settings.

The system does not receive SMS.

Bluetooth mode does not allow SMS text messages to be sent to the system.

Settings

When the treble and bass settings are changed, the ambience is deselected.**When the ambience is changed, the treble and bass settings are reset.**

Selecting an ambience imposes the treble and bass settings, and vice versa.

- ▶ Modify the treble and bass or ambience settings to obtain the desired musical ambience.

When the balance settings are changed, the distribution is deselected.**When the distribution setting is changed, the balance settings are deselected.**

Selecting a distribution setting imposes the balance settings, and vice versa.

- ▶ Modify the balance setting or the distribution setting to obtain the desired sound quality.

There is a difference in sound quality between audio sources.

To allow for optimal listening quality, the sound settings can be tailored to different audio

sources, which can generate audible differences when changing source.

► Check that the sound settings are appropriate to the sources listened to. We recommend setting the sound functions (Bass:, Treble:, Balance) to the middle position, setting the musical ambience to "None", setting loudness correction to "Active" in USB mode and "Inactive" in Radio mode.

► In all cases, after applying sound settings, adjust the volume level on the portable device (to a high level) first. Then adjust the volume level on the audio system.

When the engine is off, the system switches off after several minutes of use.

When the engine is switched off, the system's operating time depends on the state of charge of the battery.

The switch-off is normal: the system automatically goes into energy economy mode and switches off to maintain an adequate charge in the battery.

► Start the vehicle's engine to increase the charge of the battery.

The date and time cannot be set.

Setting of the date and time is only available if the synchronisation with the satellites is deactivated.

► Settings menu / Options / Time-Date setting. Select the "Time" tab and deactivate the "GPS synchronisation" (UTC).

Recording event data

Electronic control units are installed in your vehicle. These control units process data received from the vehicle's sensors, for example, or data they generate themselves or exchange with each other. Some of these control units are required for the correct operation of your vehicle, some others assist you while driving (driving or manoeuvring aids), while others provide comfort or infotainment functions.

The following contains general information about how data is processed within the vehicle.

You will find additional information about the specific data which is downloaded, stored and transmitted to third parties and what it is used for in your vehicle under the keyword "Data protection". This information is directly associated with the references for the functions in question contained in the corresponding vehicle handbook, or in the general terms and conditions of sale.

This information is also available online.

Vehicle operating data

The control units process the data used for the operation of the vehicle.

This data includes, for example:

- Information about the state of the vehicle (e.g. speed, travel time, lateral acceleration, wheel rotation rate, fastened seat belts display).
- Environmental conditions (e.g. temperature, rain sensor, distance sensor).

As a general rule, this data is temporary, is not stored for longer than one operating cycle and is only used within the vehicle itself. The control units often record this data (including the vehicle's key). This function allows either the temporary or permanent storage of information about the state of the vehicle, stresses on components, servicing requirements, as well as events and technical errors.

Depending on the vehicle's equipment level, the data stored is as follows:

- Operating state of system components (e.g. filling level, tyre pressures, battery charge status).
- Faults and malfunctions in important system components (e.g. lamps, brakes).
- System reactions in specific driving situations (e.g. deployment of an airbag, triggering of stability control and braking systems).
- Information about events which have damaged the vehicle.
- For electric and rechargeable hybrid vehicles, the traction battery charge level and the estimated driving range.

In particular circumstances (e.g. if the vehicle has detected a malfunction), it may be necessary to record data which would otherwise simply not be stored.

When taking your vehicle in for servicing (e.g. repairs, maintenance), the stored operating data may be read along with the vehicle's identification number and used if necessary.

The personnel working for the servicing network

(e.g. garages, manufacturers) or third parties (e.g. roadside assistance agents) may read the vehicle's data. This also applies to work carried out under warranty and quality assurance measures.

This data is generally read via the OBD (On-Board Diagnostics) port fitted by law to the vehicle. It is used to report on the technical state of the vehicle or its components and facilitates the diagnosis of malfunctions, in compliance with warranty obligations and for quality improvement. This data, in particular the information relating to stress on components, technical events, operator errors and other malfunctions, is sent to the Manufacturer, if necessary, along with the vehicle's identification number. The Manufacturer's liability may also be engaged. The Manufacturer may also use the operating data taken from the vehicle for product recalls. This data may also be used to check the customer's warranty and any claims made under warranty.

Any malfunctions stored in the vehicle may be reset by an after-sales service company during servicing or repair work, or at your request.

Comfort and infotainment functions

Comfort settings and personalised settings may be saved in the vehicle and modified or reinitialised at any time.

Depending on the vehicle's equipment level, this may include:

- Seat and steering wheel position settings.
- Chassis and air conditioning settings.
- Personalised settings such as the interior lighting.

You can enter your own data into the functions of your vehicle's audio and telematic system, as part of the selected functionalities.

Depending on the vehicle's equipment level, this may include:

- Multimedia data such as music, videos or photos to be read by an integrated multimedia system.
- Address book data to be used with an integrated hands-free system or with an integrated navigation system.
- Entered destinations.
- Data regarding the use of online services.

This data for the comfort and infotainment functions may be stored locally in the vehicle or saved to a device that you have connected to the vehicle (e.g. smartphone, USB memory stick or MP3 player). Data that you have entered yourself may be deleted at any time.

This data may also be transmitted outside the vehicle at your request, particularly when using online services in line with the settings that you have selected.

Smartphone integration (e.g. Android Auto® or Apple® CarPlay®)

If your vehicle is equipped accordingly, you can connect your smartphone or another mobile device to the vehicle in order to operate it using the vehicle's integrated controls. Images and sounds from the smartphone can be transmitted through the audio and telematics system.

Specific information is simultaneously sent to your smartphone. Depending on the type of integration, this includes data such as location, day/night mode and other general information about the vehicle. For more information, please refer to the user instructions for the vehicle or the audio and telematics system.

Integrating a smartphone allows you to use its applications, such as a navigation app or music player. No other integration between the smartphone and the vehicle is possible, in particular active access to vehicle data. How the data is processed subsequently is determined by the supplier of the application being used. The ability to change settings depends on the application in question and on the operating system installed on your smartphone.

Online services

If your vehicle is connected to a wireless network, data can be exchanged between your vehicle and other systems. Connection to a wireless network is made possible via a

transmitter located in your vehicle or a mobile device that you have provided (e.g. smartphone). The online services can be used via this wireless connection. These include online services and applications (apps) provided to you by the Manufacturer or other suppliers.

Exclusive services

As regards the Manufacturer's online services, the corresponding functions are described by the Manufacturer in an appropriate medium (e.g. handbook, Manufacturer's website) and the information about data protection is provided. Personal data may be used for online services. The exchange of data for this purpose takes place over a secure connection, using for example the Manufacturer's dedicated computer systems. The collection, processing and use of personal data for the development of services are carried out solely on the basis of a legal authorisation, for example in the case of a legal emergency call system or a contractual agreement or else under a consent agreement. You can activate or deactivate the services and functions (some may be chargeable) and, in some cases, the vehicle's entire connection to the wireless network. This does not include the statutory functions and services such as the emergency or assistance call system.

Third-party services

If you use online services provided by other (third-party) suppliers, these services are subject

to the responsibility, the data protection and the terms and conditions of use of the supplier in question. The Manufacturer often has no influence over the content exchanged in this regard.

Please therefore ensure that you are aware of the nature, extent and purpose of the collection and use of personal data as part of the third-party services provided by the service provider in question.

180° rear vision 131
 360 Vision 130

A

ABS 69
 Accelerated charging unit (Wallbox) 141
 Accessories 66
 Active Safety Brake 122–124
 AdBlue® 20, 160
 AdBlue® tank 161
 Additive, Diesel 158
 Adjusting headlamps 59
 Adjusting head restraints 40
 Adjusting seat 40–41
 Adjusting the air distribution 49–50
 Adjusting the air flow 49–50
 Adjusting the date 206, 229
 Adjusting the height and reach
 of the steering wheel 42
 Adjusting the lumbar support 41
 Adjusting the seat angle 41
 Adjusting the temperature 48, 50
 Adjusting the time 206, 230
 Advice on care and maintenance 139, 162
 Advice on driving 7, 84–85
 Airbags 73, 75, 77
 Airbags, curtain 74–75
 Airbags, front 74–75, 77
 Airbags, lateral 74–75
 Air conditioning 46–47, 49

Air conditioning, automatic 50
 Air conditioning, dual-zone automatic 47, 50
 Air conditioning, manual 47, 50
 Air intake 50
 Air vents 45
 Alarm 35–36
 Amplifier, audio 54
 Android Auto connection 204, 221
 Anti-lock braking system (ABS) 69
 Antitheft / Immobiliser 29
 Apple CarPlay connection 203, 220
 Applications 221
 Assistance call 67–68
 Assistance, emergency braking 70, 124
 Audible warning 67
 Audio streaming (Bluetooth) 200, 225

B

Battery, 12 V 153, 158, 175–177
 Battery, ancillaries 175
 Battery, charging 175–176
 Battery, remote control 33–34
 Blind 38–39
 Blind spot sensors 121
 BlueHDi 20, 158, 165
 Bluetooth (hands-free) 201–202, 226
 Bluetooth (telephone) 201–202, 226–227
 Bluetooth touch screen audio system 24
 Bodywork 163
 Bonnet 154–155

Boot 35, 56
 Brake discs 159
 Brake lamps 174
 Brakes 159
 Braking 95
 Braking assistance system 69–70
 Braking, automatic emergency 122–124
 Braking, dynamic emergency 90–92
 Brightness 205
 Bulbs 173
 Bulbs (changing) 171–172, 174

C

Cable, audio 224
 Cable, Jack 224
 Capacity, fuel tank 137
 Cap, fuel filler 137
 Care of the bodywork 163
 Central locking 31–32
 Changing a bulb 171–172, 174
 Changing a fuse 174
 Changing a wheel 169
 Changing a wiper blade 64
 Changing the remote control battery 33
 Changing to free-wheeling 178
 Charge level indicator (Electric) 21
 Charger, induction 53
 Charger, wireless 53
 Charging cable 142
 Charging cable (Electric) 141

Charging connector (Electric) 140, 145, 147–148
 Charging flap (Electric) 140, 145, 147–148
 Charging system (Electric) 5, 8, 26, 138, 156
 Charging the traction battery (Electric) 21, 138, 142, 145, 147–148
 CHECK 22
 Checking the engine oil level 19
 Checking the levels 156–157
 Checking tyre pressures (using the kit) 166, 168
 Checks 155, 158–160
 Checks, routine 158–159
 Child lock 83
 Children 72, 78–80
 Children (safety) 83
 Child seats 72, 75–78
 Child seats, conventional 78, 81–82
 Child seats, i-Size 80–82
 Child seats, ISOFIX 78–79, 81–82
 Cleaning (advice) 139, 162–163
 Closing the boot 31, 35
 Closing the doors 31, 35
 Collision Risk Alert 122–123
 Configuration, vehicle 25–26
 Connected applications 221
 ConnectedCAM Citroën™ 100
 Connection, Bluetooth 201–202, 221–222, 226–227
 Connection, Wi-Fi network 222
 Connectivity 220
 Consumption figures 26

Container, AdBlue® 160–161
 Control, emergency boot release 35
 Control, emergency door 32–33
 Control, heated seats 42, 45
 Controls, steering mounted 93–94
 Control stalk, lighting 57–58
 Control stalk, wipers 62–63
 Control unit 141–142
 Courtesy lamps 55
 Cruise control 104–105, 107–108
 Cruise control, adaptive 104–105, 109
 Cruise control by speed limit recognition 104–105

D

DAB (Digital Audio Broadcasting) - Digital radio 199–200, 224
 Date (setting) 206, 229
 Daytime running lamps 58, 173
 Deactivating the passenger airbag 74, 77
 Deadlocking 29, 31
 Deferred charging 27
 Deferred charging (Electric) 26–27, 140, 145, 148
 Defrosting 43, 50
 Defrosting, front 50
 Demisting 43, 50
 Demisting, front 50
 Demisting, rear 51
 Demisting, rear screen 51

Dials and gauges 9–10
 Digital instrument panel 10
 Dimensions 185
 Dipstick 19, 156
 Direction indicators 58, 173–174
 Display, head-up 11
 Display screen, instrument panel 9
 Domestic charging (Electric) 142, 147–148, 184
 Doors 35
 Drive Assist Plus 109
 Driver's attention warning 125
 Drive selector (Electric) 94
 Driving 84–85
 Driving aids camera (warnings) 101
 Driving aids (recommendations) 101
 Driving economically 7
 Driving modes 95–96
 Dynamic stability control (DSC) 70

E

EBFD 69
 Eco-driving (advice) 7
 ECO mode 96
 Economy mode 153
 Electric motor 5, 8, 22, 26, 138, 150, 156, 175, 178, 184
 Electric windows 37
 Electronic brake force distribution (EBFD) 69
 Emergency braking assistance (EBA) 70

Emergency call 67–68
 Emergency switching off 88–89
 Emergency warning lamps 66, 165
 Emissions control system, SCR 21, 160
 Energy economy mode 153
 Energy flows 22, 26
 Energy recovery 21, 95
 Engine 160
 Engine compartment 155
 Engine, Diesel 137, 155, 165, 183
 Engine, petrol 155, 182
 Engines 181–183
 Environment 7, 34, 85
 ESC (electronic stability control) 69
 Expanded traffic sign recognition 105
 Exterior lighting 60

F

Fatigue detection 125
 Filling the AdBlue® tank 158, 161
 Filling the fuel tank 137–138
 Filter, air 158
 Filter, oil 158
 Filter, particle 158
 Filter, passenger compartment 46, 158
 Fitting a wheel 169, 171
 Fitting roof bars 152–153
 Fittings, boot 55
 Fittings, interior 52
 Flap, fuel filler 137–138

Flashing indicators 58, 173
 Floor, boot, adjustable 56
 Fluid, brake 157
 Fluid, engine coolant 157
 Foglamp, rear 57, 174
 Foglamps, front 57, 61
 Folding the rear seats 44–45
 Frequency (radio) 223
 Fuel 7, 137
 Fuel consumption 7
 Fuel tank 137–138
 Fuses 174

G

Gauge, fuel 137
 Gearbox, automatic 92–94, 96, 159, 175
 Gearbox, manual 92, 96, 159
 Gear lever, manual gearbox 92
 Gear shift indicator ~ Gear efficiency indicator 97
 Glove box 52
 G.P.S. 217

H

Hazard warning lamps 66, 165
 Headlamp adjustment 59
 Headlamps, automatic dipping 60–61
 Headlamps, automatic illumination 59

Headlamps, dipped beam 173
 Headlamps, halogen 59, 173
 Headlamps, main beam 60, 173
 Head restraints, front 40
 Head restraints, rear 44–45
 Head-up display 10–11
 Heated steering wheel 42
 Heating 45, 47
 Heating, programmable 27, 51
 Hi-Fi system 54
 High voltage 138
 Hill start assist 96–97
 Histogramme, fuel consumption 26–27
 Horn 67

I

Ignition 88, 227
 Ignition on 88
 Ignition switch 86–87
 Immobiliser, electronic 86
 Indicator, AdBlue® range 20
 Indicator, coolant temperature 19
 Indicator, engine oil level 19
 Indicators, direction 58, 173
 Inflating tyres 159, 185
 Inflating tyres and accessories (using the kit) 166, 168
 Information, vehicle 9, 234
 Infrared camera 102
 Instrument panel 9, 22, 24, 102

Instrument panel, LCD 9
 Internet browser 218, 221
 ISOFIX mountings 78, 81–82

J

Jack 165–166, 169, 224
 Jump starting 176

K

Key 28–29, 32–33
 Key, electronic 30–31
 Keyless Entry and Starting 28, 30–31, 87–88
 Key not recognised 88–89
 Key with remote control 28, 86
 Kit, hands-free 201–202, 226
 Kit, puncture repair 166
 Kit, temporary puncture repair 165–168

L

Labels, identification 185
 Lamp, boot 56
 Lamps, parking 58
 Lamps, rear 174
 Lams with Full LED technology 61
 Lane assist 109, 113–115
 Lane departure warning active 118

Leather (care) 163
 LEDs - Light-emitting diodes 58, 172, 174
 Level, AdBlue® 158
 Level, brake fluid 157
 Level, Diesel additive 158
 Level, engine coolant 19, 157
 Level, engine oil 19, 156
 Levels and checks 155–157
 Level, screenwash fluid 63, 157
 Light-emitting diodes - LEDs 58, 172, 174
 Lighting, cornering 61
 Lighting dimmer 23
 Lighting, exterior 57, 60
 Lighting, guide-me home 29, 59–60
 Lighting, interior 55
 Lighting, mood 55
 Lighting, welcome 59
 Loading 152–153
 Load reduction mode 154
 Locking 29, 31
 Locking from the inside 32
 Locking the doors 32
 Low fuel level 137
 Lumbar 41

M

Mains socket (domestic network) 141
 Maintenance (advice) 139, 162
 Maintenance, routine 102, 158–160
 Manoeuvring aids (recommendations) 101

Map reading lamps 55
 Markings, identification 185
 Massage function 41
 Mat 54, 102
 Menu, main 26
 Menus (audio) 197–198, 210–211
 Menu short cuts 26
 Messages 228
 Messages, quick 228
 Minimum traction battery charge level (Electric) 21
 Mirror, rear view 43
 Mirrors, door 43, 51, 121
 Mirror, vanity 52
 Misfuel prevention 138
 Mobile application 27, 51, 148
 Motor, electric 89, 156, 184
 Mountings, ISOFIX 78, 81–82
 Multimedia support 52

N

Navigation 215–217
 Navigation, connected 218–220

O

Obstacle detection 126
 Oil change 156
 Oil consumption 156

Oil, engine 156
 On-board tools 56, 165–166
 Opening the bonnet 154
 Opening the boot 30, 35
 Opening the doors 30, 35
 Opening the windows 28

Priming the fuel system 165
 Profiles 229
 Protecting children 74–80
 Proximity Keyless Entry & Start 30
 Public fast charging station 141, 147
 Puncture 166–167, 169

Reminder, lighting on 57–58
 Remote control 28–32
 Remotely operable functions
 (Electric) 27, 51, 148
 Removing a wheel 169–171
 Removing the mat 54
 Replacing bulbs 171–172, 174
 Replacing fuses 174
 Replacing the air filter 158
 Replacing the oil filter 158
 Replacing the passenger compartment
 filter 158
 Reservoir, screenwash 157
 Reset trip 24
 Retractable support 52
 Rev counter 9–10
 Reversing camera 102, 127–130
 Reversing lamps 174
 Roof bars 152–153
 Roof, opening 38–39
 Running out of fuel (Diesel) 165

P

Pads, brake 159
 Paint 163, 185
 Paint colour code 185
 Park Assist 132
 Parking brake 89, 159
 Parking brake, electric 90–92, 159
 Parking sensors, audible and visual 126
 Parking sensors, front 127
 Parking sensors, rear 126
 Passenger compartment temperature pre-
 conditioning (Electric) 27, 51
 Pedestrian horn (Electric) 67, 85
 Personalisation 10
 Plates, identification 185
 Player, Apple® 200, 225
 Player, USB 200, 224
 Port, USB 52, 200, 203, 220, 224
 Post Collision Safety Brake 70
 Power 21
 Power indicator (Electric) 8, 21
 Pressures, tyres 159, 167, 185
 Pre-tensioning seat belts 72

R

Radar (warnings) 101
 Radio 198, 223
 Radio, digital (Digital Audio
 Broadcasting - DAB) 199–200, 224
 Range, AdBlue® 20, 158
 RDS 199, 223
 Reading lamps 55
 Rear screen, demisting 51
 Recharging the battery 175–176
 Recharging the traction battery
 (Electric) 138, 142, 145, 147–148
 Recirculation, air 50
 Recovery 178–180
 Recovery of the vehicle 178–179
 Reduction of electrical load 154
 Regeneration of the particle filter 158
 Regenerative braking (deceleration
 by engine braking) 94–95
 Reinitialisation of the under-inflation
 detection system 99–100
 Reinitialising the remote control 34
 Reminder, key in ignition 87

S

Safety, children 74–80
 Saturation of the particle filter (Diesel) 158
 Screenwash 63
 Screenwash, front 62
 SCR (Selective Catalytic Reduction) 21, 160
 Seat angle 41
 Seat belts 71–72, 78

- Seat belts, rear 71
 Seat, rear bench 44
 Seats, electric 41
 Seats, front 40–41
 Seats, heated 42, 45
 Seats, rear 44–45, 76
 Selector, gear 92, 94
 Sensors (warnings) 102
 Serial number, vehicle 185
 Service indicator 18, 22
 Servicing 18, 158–160
 Settings, equipment 25–26
 Settings, system 205, 229
 Sidelamps 58, 173–174
 Side parking sensors 127
 Silent vehicle warning sound (Electric) . . . 67, 85
 Smartphone 27, 52–53
 Snow chains 99, 153
 Socket, 12 V accessory 53
 Socket, auxiliary 224
 Socket, Jack 224
 Speakers 54
 Speed limiter 104–106
 Speed limit recognition 102, 104
 Speedometer 9–10, 102
 Sport mode 96
 Spotlamps, side 60
 Stability control (ESC) 69
 Starting a Diesel engine 137
 Starting the engine 86, 89
 Starting the vehicle 86–87, 94
 Starting using another battery 88, 176
 Station, radio 198, 223
- Stay, bonnet 154–155
 Steering mounted controls, audio 197, 210
 Steering wheel, adjustment 42
 Stickers, customising ~ Stickers,
 expressive 163
 Stopping the vehicle 86–88, 94
 Stop & Start 24, 46, 50, 97–98,
 137, 154, 158, 178
 Storage 52
 Storage box 56
 Storage wells 56
 Sunshine sensor 46
 Sun visor 52
 Super-fast charging (Electric) 147–148, 184
 Suspension 159
 Switching off the engine 86, 89
 Synchronising the remote control 34
-
- T**
- Tables of engines 184
 Tank, fuel 137–138
 Technical data 182–184
 Telephone 201–203, 226–228
 Temperature, coolant 19
 Thermal comfort consumption indicator
 (Electric) 22
 Thermal comfort equipment 22
 Time (setting) 206, 230
 TMC (Traffic info) 217
 Tool box 56
 Tools 165–166
- Topping-up AdBlue® 161
 Top Rear Vision 128–129
 Top Tether (fixing) 78, 81–82
 Total distance recorder 23
 Touch screen 24–26, 51
 Touch screen tablet 25, 52
 Towball, quickly detachable 150–152
 Towbar 149
 Towbar with quickly detachable
 towball 150–152
 Towed loads 181–183
 Towing another vehicle 178, 180
 Traction battery (Electric) 21–22, 26,
 138, 140, 184
 Traction control (ASR) 70
 Traffic information (TMC) 217
 Trailer 149
 Trajectory control systems 69
 Triangle, warning 165
 Trip computer 23–24
 Trip distance recorder 23
 Tyres 159, 185
 Tyre under-inflation detection 99, 167
-
- U**
- Under-inflation (detection) 99
 Unlocking 28, 30
 Unlocking from the inside 32
 Unlocking the doors 32
 Updating the date 206, 229
 Updating the time 206, 230

USB 200, 203, 220, 224

V

Vehicle data recording and privacy 234
 Ventilation 45–47
 Video 225
 Visibility 50
 Vision, 180° forward 131
 Vision 360° 128
 Voice commands 212–215

W

Wallbox (Electric) 141
 Warning and indicator lamps 12
 Warning lamp, driver's seat belt
 not fastened 72
 Warning lamps 12, 22
 Warning lamp, seat belts 72
 Warnings and indicators 12
 Washing 102
 Washing (advice) 139, 162–163
 Weights 181–183
 Welcome lighting 29, 60
 Wheel, spare 159, 165–166, 169
 Windscreen, heated 50–51
 Windscreen wipers 62–63
 Wiper blades (changing) 64
 Wipers 62
 Wipers, automatic rain sensitive 63

Automobiles CITROËN declares, in accordance with the provisions of European legislation (Directive 2000/53) relating to End-of-Life Vehicles, that it achieves the objectives set by this legislation and that recycled materials are used in the manufacture of the products that it sells.

Reproducing and translating this document, even partially, is strictly prohibited without written authorisation from Automobiles CITROËN.

4DCONCEPT
Groupe MAURY Imprimeur



Printed in the EU
10-21

Automobiles CITROËN

Siège social : 2-10, boulevard de l'Europe - 78300 POISSY

www.citroen.com

Société anonyme au capital de 159 000 000 € - R.C.S. VERSAILLES : 642 050 199



ANG. 21C41.0040

